

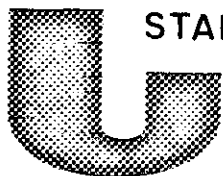

Department of consumer and corporate affairs / Ministère de la consommation et des corporations



STANDARDS BRANCH - DIRECTION DES NORMES

NOTICE OF APPROVAL

S.WA-768

OTTAWA October 31, 1969.

Approved: TORSION BALANCE TEST SCALES SERIES DLT, DWL

manufactured by The Torsion Balance Co. (Canada) Ltd., 4927 Sherbrooke Street W., Montreal, Quebec.

Apparatus Listed: Test Scales, equal arm balance type, with graduated balance indicator, and with one or two dial type weight balancing controls.

| | |
|--------------|--|
| Model DWL2 | Fine and coarse balance controls. |
| Model DWL2-1 | Same as DWL2, but with commodity scoop rather than platter. |
| Model DLT2 | Same as DWL2, but with fine balance control only. |
| Model DLT2-1 | Same as DLT2 but with commodity scoop rather than platter. |
| Model DWL3 | Fine and coarse balance controls. |
| Model DWL3V | Same as DWL3 but with higher capacity of balance control and balance indication. |
| Model DWL5 | Fine and coarse balance controls. |
| Model DLT5 | Same as DWL5 but with fine balance control only. |

Rating of Apparatus: Maximum capacities -

| | |
|-----------------------------------|--------------|
| Models DWL2, DWL2-1, DLT2, DLT2-1 | - 120 grams. |
| Models DWL3, DWL3V | - 200 grams |
| Models DWL5, DLT5 | - 500 grams. |

Application: The measurement of moisture content and other test variables.

Description: These balances are equal arm type, operating on the Roberval principle. Taut metal bands acting in torsion serve as pivots. The mechanism is typical of that used in all previously-approved balances manufactured by the Torsion Balance Company. This mechanism utilizes three rectangular frames, each of which is encircled by a taut metal band. An upper and a lower beam connect the three frames, the beams being fastened to the bands. The band encircling the centre frame is attached to the balance base and acts as the pivot point of the balance. The fine weighing control mechanism consists of a spirally-wound resistance spring which acts on the beam. Spring loading is varied by means of a calibrated manual control knob.

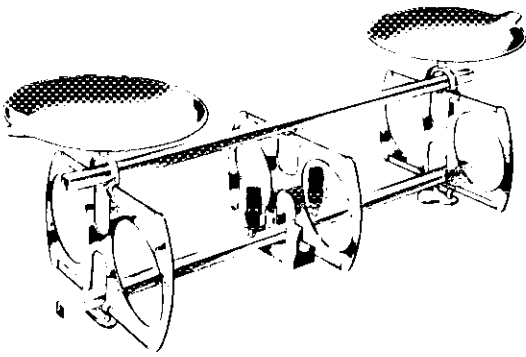

TORSION BALANCE MECHANISM

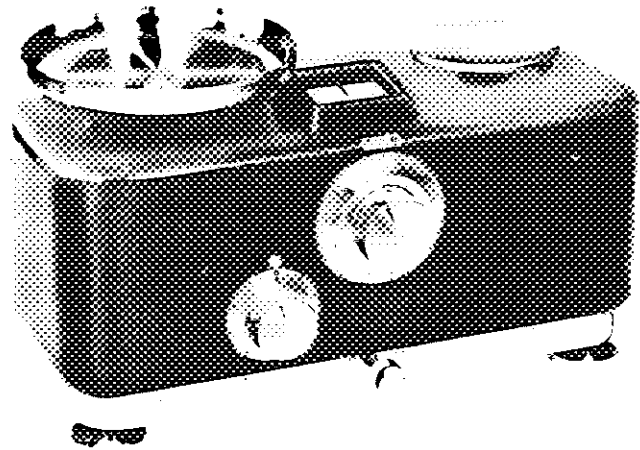

MODELS DWL₃, DWL₅

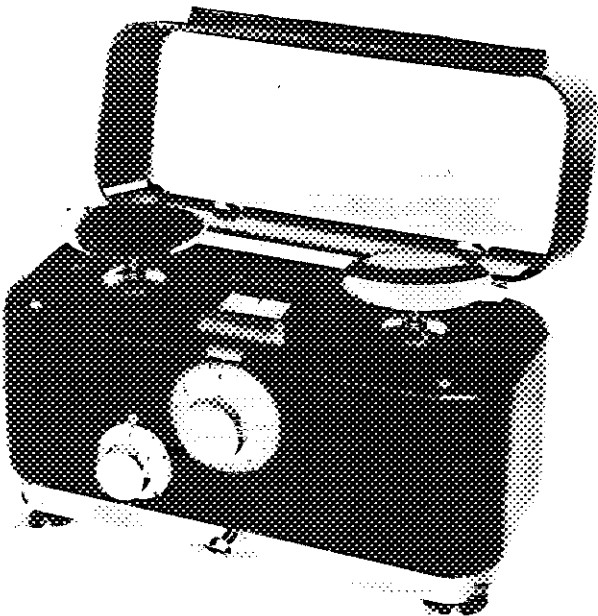

MODEL DWL₂

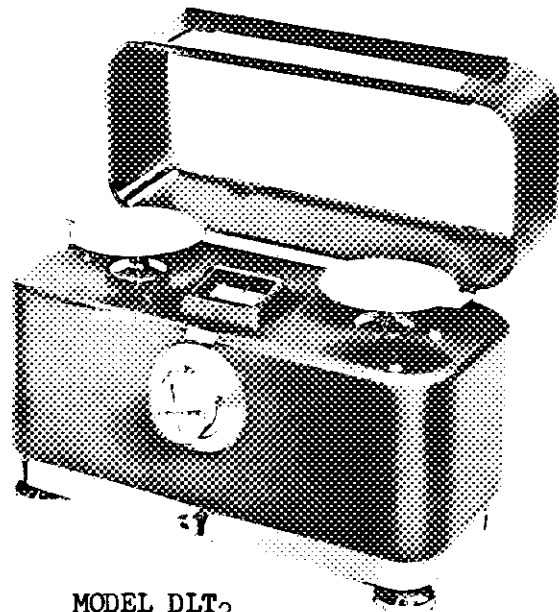

MODEL DLT₂

Description: cont'd

The coarse weighing control mechanism utilizes a series of drop weights which are activated by means of a calibrated manual control knob.

Balance condition is indicated by means of a graduated "over and under" indicator.

Balance housings are of sheet steel with enamel finish. Bases are of cast construction and are equipped with levelling feet. Models of 120 gram capacity are equipped with a hinged cover having a glass window.

Commodity holders may be flat platters, dished pans or scoops.

Testing: The standard tests for equal arm scales shall apply.

References: SW-85-T1
SL-102-653

Note: Approval is granted under the Weights and Measures Act, Chapter 292, and Regulations thereunder (P.C. 6894) for use in Canada under the general conditions of P.C. 6894, and under any special conditions listed above.

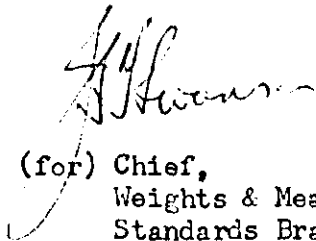
(for) Chief,
Weights & Measures Division,
Standards Branch.

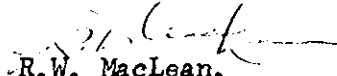
R. W. MacLean,
Director,
Standards Branch.