



Department of consumer and corporate affairs / Ministère de la consommation et des corporations



STANDARDS BRANCH - DIRECTION DES NORMES

# NOTICE OF APPROVAL

G-57-1

OTTAWA February 10, 1971.

DRESSER MEASUREMENT DIVISION  
ROOTS, ROTARY TEMPERATURE COMPENSATED,  
POSITIVE DISPLACEMENT GAS METER

This approval supersedes circular G-57, dated August 15, 1969.

### Apparatus

<u>Series Designation</u>	<u>Model Designation</u>	<u>Max. Static Pressure * spig</u>	<u>Max. Displacement cu.ft./hr</u>
125AL-TC	1.5M125-TC	125	1,500
125LM-TC	3M125-TC	125	3,000
125LM-TC	5M125-TC	125	5,000
125LM-TC	7M125-TC	125	7,000
125LM-TC	11M125-TC	125	11,000

\*NOTE: These meters are not equipped with an instrument drive for auxiliary pressure correcting devices and they are intended, and APPROVED FOR USE ON LOW PRESSURE ONLY of approximately seven ounces per square inch or less.

Temperature Compensation Range -20°F to +100°F

Base Temp. (Compensated Volume) 60°F

Meters Ambient Temperature Range -40°F to +140°F

### Description

#### Series 125LM-TC Meter

These temperature compensated, positive displacement rotary gas meters consist of two two-lobed, straight aluminum impellers, or rotors, contained in a cylindrical metering casing, formed of a one piece casting of gray iron. The metering chamber is closed at the ends by headplates of cast iron, and by gas tight end-covers sealed with O-rings. All rotating parts are carried by the two headplates. One end cover contains the timing gears

DRESSER MEASUREMENT DIVISION ROOTS, ROTARY TEMPERATURE COMPENSATED, POSITIVE DISPLACEMENT GAS METER

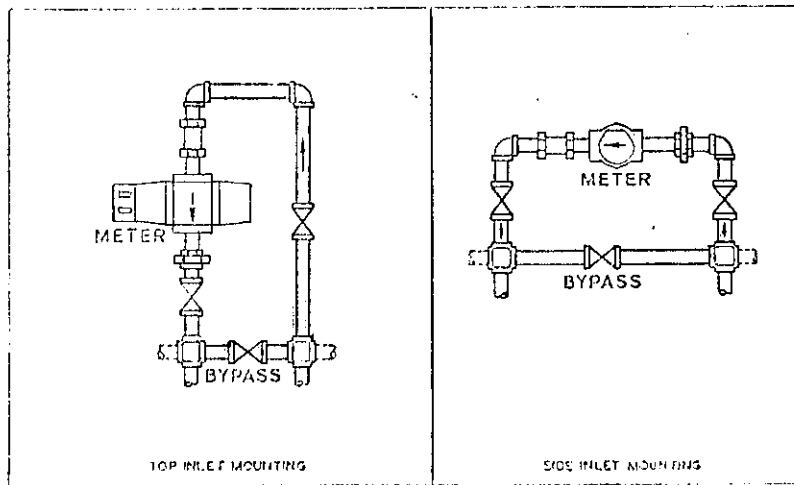

Suggested Installations of Series 125AL-TC Rotary Meters

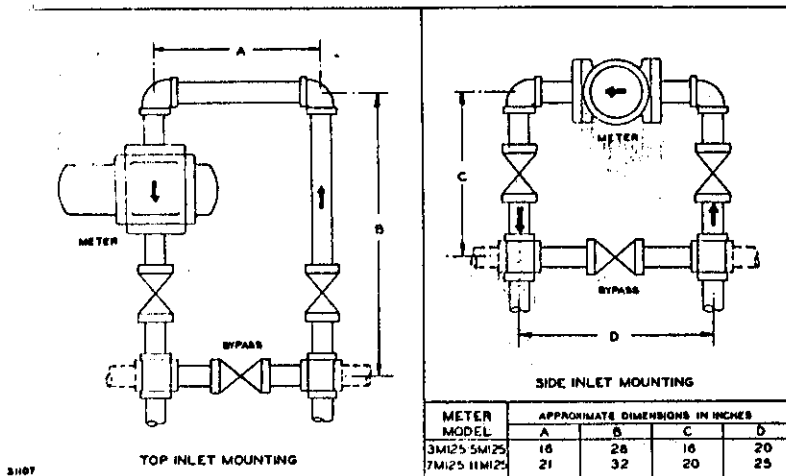

SUGGESTED INSTALLATIONS OF T-C LINE-mounted Rotary Meters

METER OIL CAPACITIES

Meter Size	Approximate Capacity in Fluid Ounces					
	In Vertical Pipe Line			In Horizontal Pipe Line		
	Timing End	T-C End	T-C Unit	Timing End	T-C End	T-C Unit
1.5M125	3 3/4	4	5 1/2	3/4	1 1/4	3 3/4
3M125 and 5M125	4	4 3/4	5 1/2	1/2	1/2	3 3/4
7M125 and 11M125	12 1/2	14 3/4	5 1/2	2 1/2	2 3/4	3 3/4

which fix the relative position of the impellers to each other and provide for their contrarotation, while the other cover, at the counter end of the meter, encloses a radial type magnetic coupling. A plastic, see-through dome, screwed to the latter cover contains the temperature compensation mechanism, gear reduction unit, two odometer type registers and discs or dials, intended for test purposes. Two arrangements of these dials are approved, as shown on drawings Nos. DO45970 and DO46731. The version shown on drawing No. DO46731 has been introduced by the manufacturer lately and will be used on all sizes of new temperature compensated meters.

Gears and bearings at each end of the meter are continuously lubricated with oil by dip and splash method, the oil being supplied from three independent sumps formed by the two end covers and the T-C unit plastic cover. Each sump is provided with visual type oil level indicator and with plugged filling and draining holes. A general purpose instrument grade oil having an approximate viscosity of 50 to 60 SSU at 100°F is recommended. (See table for meter oil capacities).

The temperature compensation is accomplished by a mechanical computer utilizing intermittent integration. The compensating unit is driven through a radial type magnetic coupling. The temperature sensor consists of a spiral bi-metal element installed in a sealed well containing a heat conductive silicone compound. The well extends from the end of the meter end cover through the headplate and into the gas stream at the meter inlet. The well is sealed by O-rings to prevent gas leakage to outside and leakage of oil through the headplate into the meter. The temperature compensating unit also incorporates a temperature indicator which reveals approximate temperature of the flowing gas.

The meters are equipped with two seven-digit counter-type registers. A combination nameplate and counter mask covers the lowest two digits so that the volume registration is in 100 cu. ft. increments for both temperature compensated and uncompensated volume.

#### Series 125AL-TC Meter

This meter, available in 1.5M size only, has its casing formed of a one-piece aluminum alloy extrusion. Inlet and outlet gas connections are  $1\frac{1}{2}$  inch, threaded pipe nipples 3 inches in length. The metering chamber is closed at the ends by headplates of die cast aluminum, and by gas tight end covers of the same material with bolted joints being sealed with O-rings.

Except as noted above, the basic construction features of the Series 125AL-TC meter are the same as for the Series 125LM-TC.

The meters of both Series may be mounted in either horizontal or vertical gas lines which carry clean and dry gas. Preferred installation, however, is in a vertical pipe line due to self-cleaning action of the meter.

# DRESSER MEASUREMENT DIVISION ROOTS, ROTARY TEMPERATURE COMPENSATED, POSITIVE DISPLACEMENT GAS METER

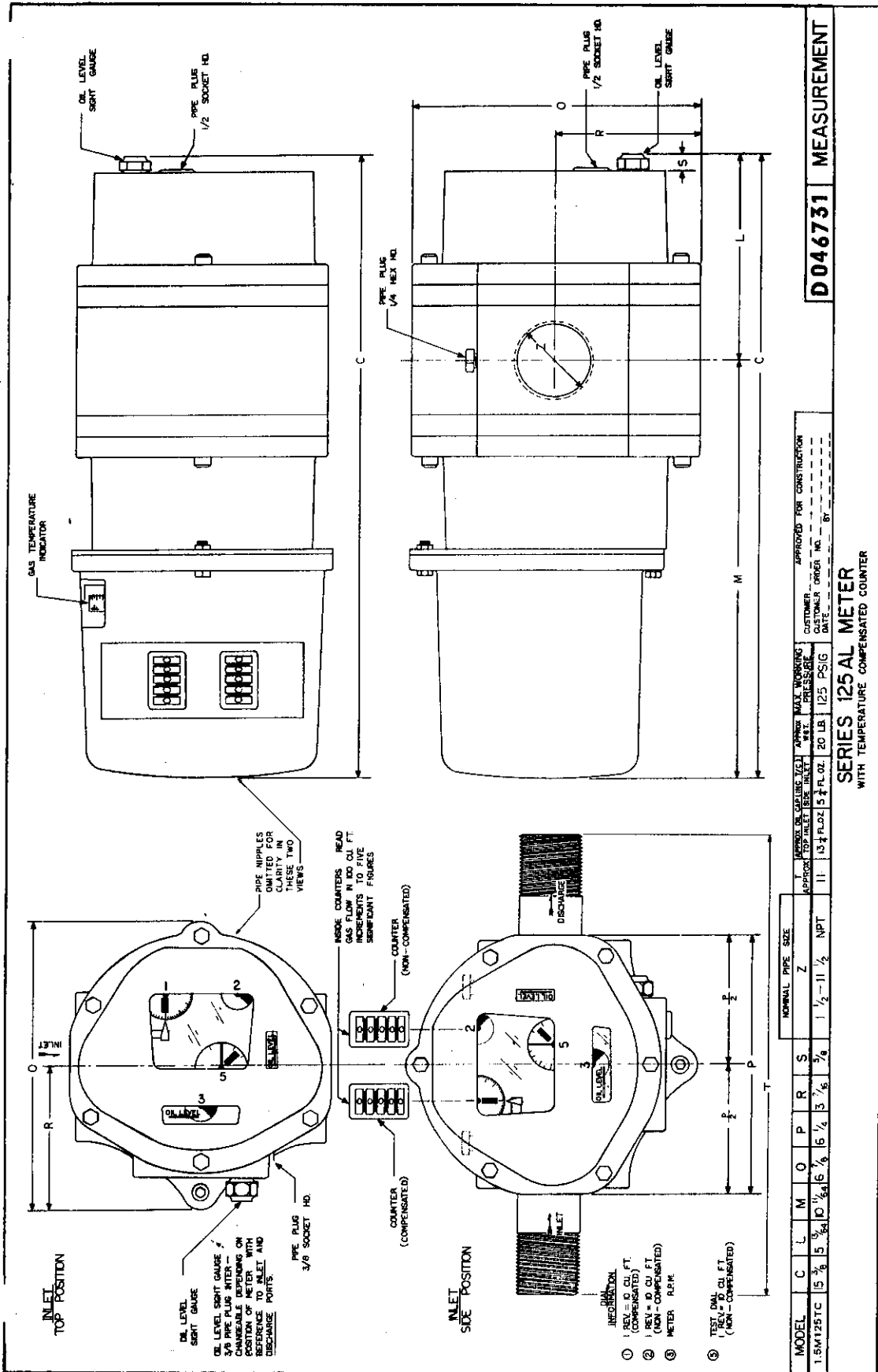

D046731 MEASUREMENT

## SERIES 125A METER WITH TEMPERATURE COMPENSATED COUNTER

APPROVED FOR CONSTRUCTION  
 CUSTOMER ORDER NO. \_\_\_\_\_  
 DATE \_\_\_\_\_

APPROX MAX WORKING PRESSURE 20 LB / 125 PSIG  
 APPROX MAX WORKING TEMPERATURE 300 F / 150 C

MODEL	C	L	M	O	P	R	S	NORMAL PIPE SIZE
1.5M125C	5 3/8	5 9/16	10 1/4	6 1/4	6 1/4	3 7/8	3 7/8	1/2 - 1 1/2 NPT

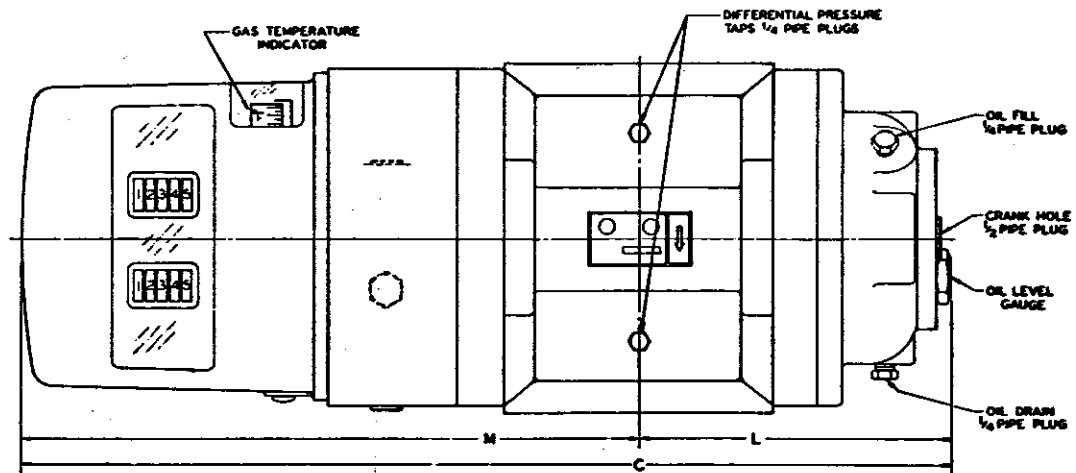
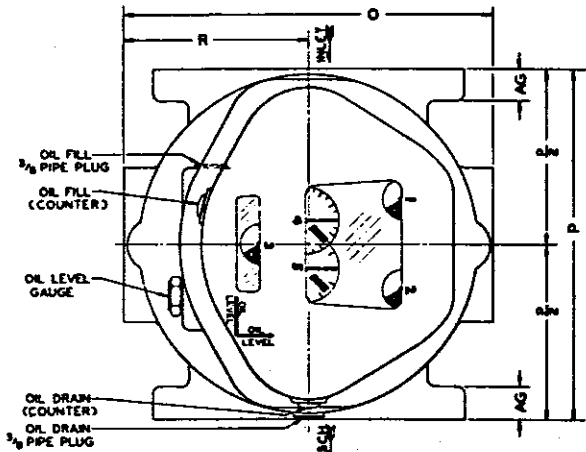

TOP INLET

INSIDE COUNTERS-READS GAS FLOW IN 100 CU.FT INCREMENTS TO FIVE SIGNIFICANT FIGURES

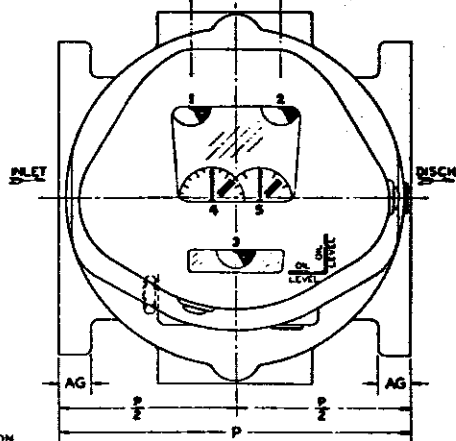
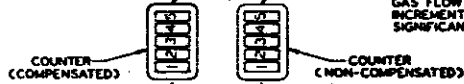

**DIAL INFORMATION**

- 1-1 REV-10 CUFT (COMPENSATED)
- 2-1 REV-10 CUFT (NON-COMPENSATED)
- 3-METER RPM
- 4-TEST DIAL 1 REV-2 CUFT (NON-COMPENSATED)
- 5-TEST DIAL 1 REV-10 CUFT (NON-COMPENSATED)

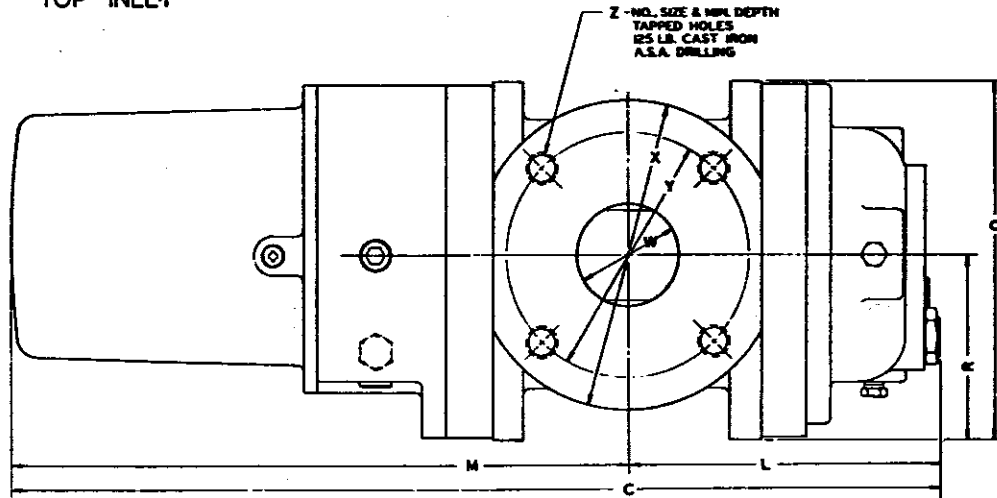

SIDE INLET

APPROVED FOR CONSTRUCTION

CUSTOMER \_\_\_\_\_

CUST ORD NO. \_\_\_\_\_

DATE \_\_\_\_\_ BY \_\_\_\_\_

MODEL	* NOMINAL PIPE SIZE										AG	APPROX OIL CAPACITY SIDE INLET	APPROX. CAPACITY TOP INLET	WEIGHT	MAX WORKING PRESSURE
	C	L	M	O	P	R	W <sub>g</sub>	X	Y	Z					
3M125	17 3/8	6 3/4	12 1/2	7 1/8	6 3/4	3 3/8	2	6	4 3/8	4	3/8-11	15/16	3/8		125 PSIG
5M125	21 3/8	7 1/2	13 1/2	7 7/8	6 3/4	3 3/8	3	7 1/2	6	4	3/8-11	15/16	3/4		125 PSIG
7M125	25 3/8	8 1/2	13 3/4	8 1/2	6 3/4	4 1/8	3	7 1/2	6	4	3/8-11	15/16	3/4		125 PSIG
11M125	26 3/4	10 1/2	15 3/8	9 1/2	6 3/4	4 1/8	4	9	7 1/2	8	3/8-11	15/16	1/2		125 PSIG

**SERIES 125 METER**  
WITH TEMPERATURE COMPENSATED COUNTER

D045970

ROOTS, ROTARY TEMPERATURE COMPENSATED, POSITIVE DISPLACEMENT GAS METER  
SERIES 125AL-TC

---

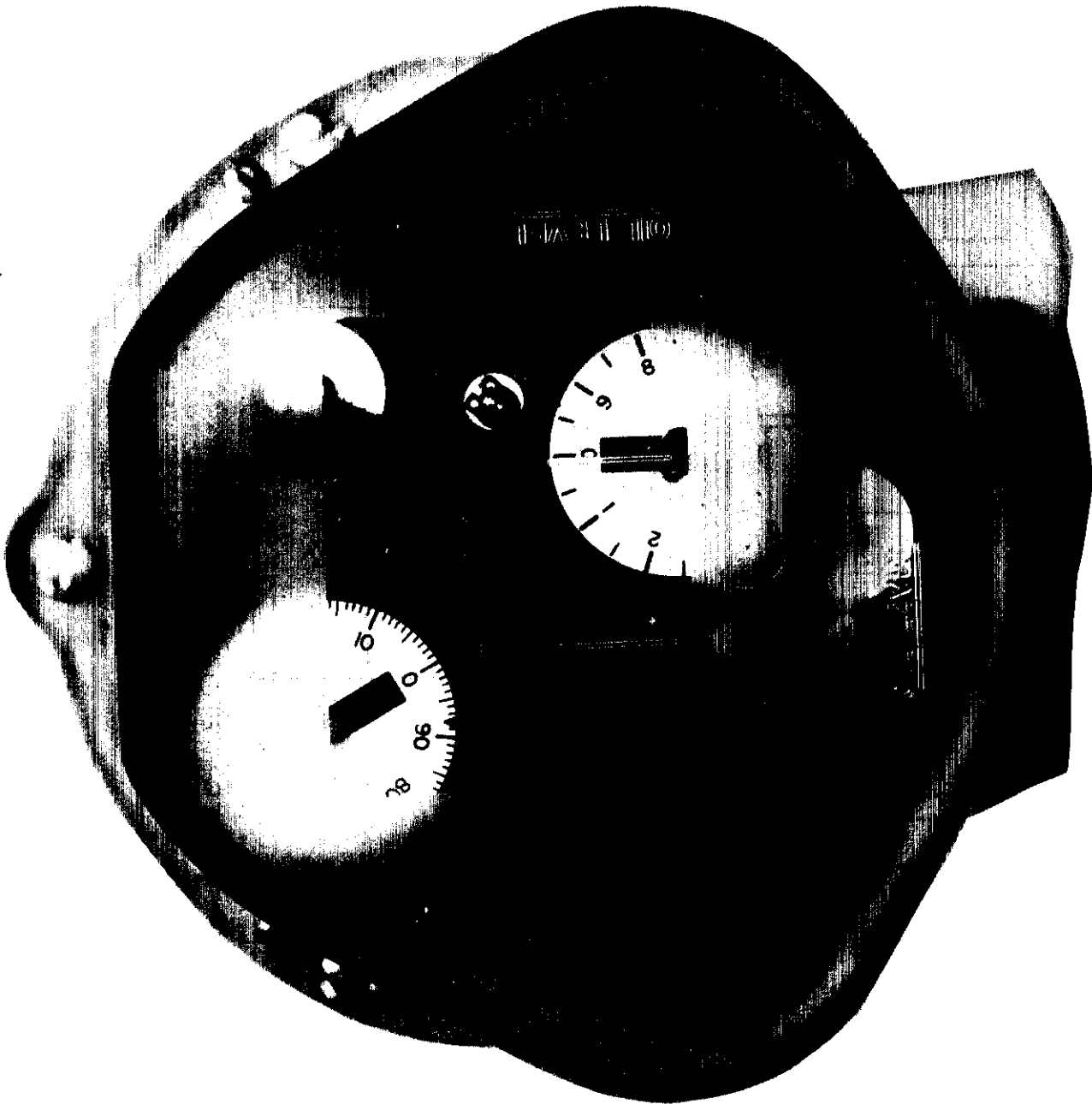

ROOTS, ROTARY TEMPERATURE COMPENSATED, POSITIVE DISPLACEMENT GAS METER  
SERIES 125AL-TC

---

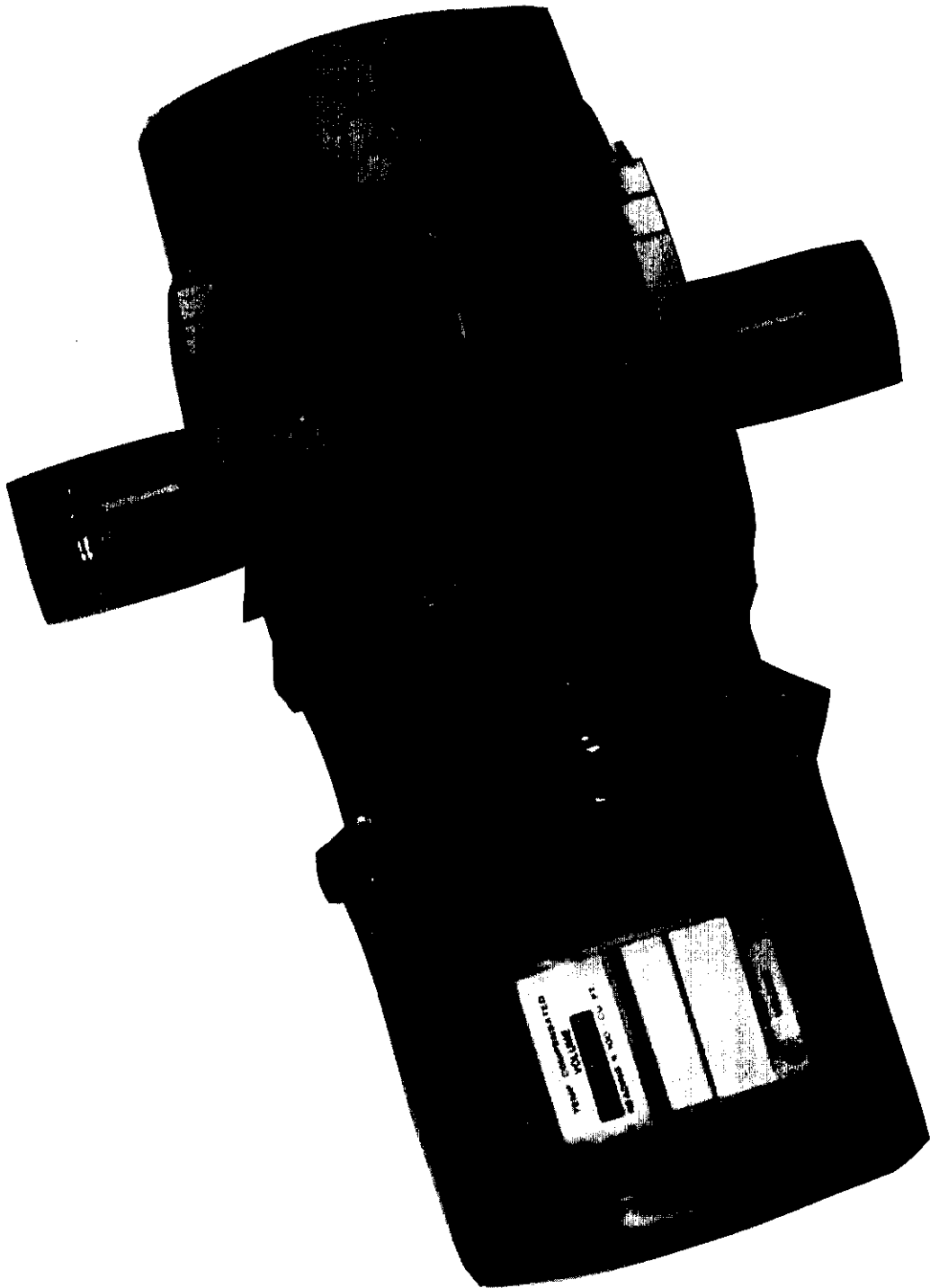

ROOTS, ROTARY TEMPERATURE COMPENSATED, POSITIVE DISPLACEMENT GAS METER  
SERIES 125LM-TC

---

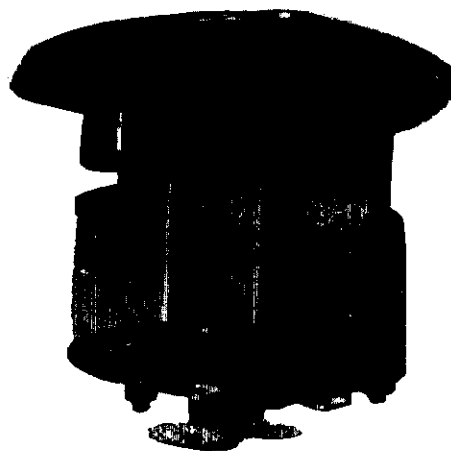
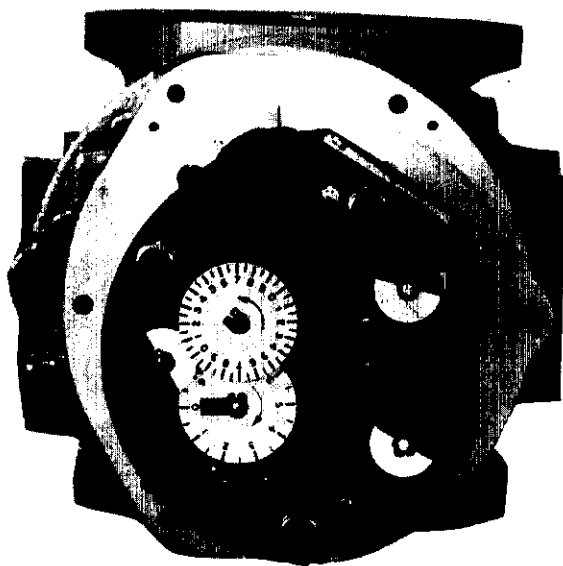
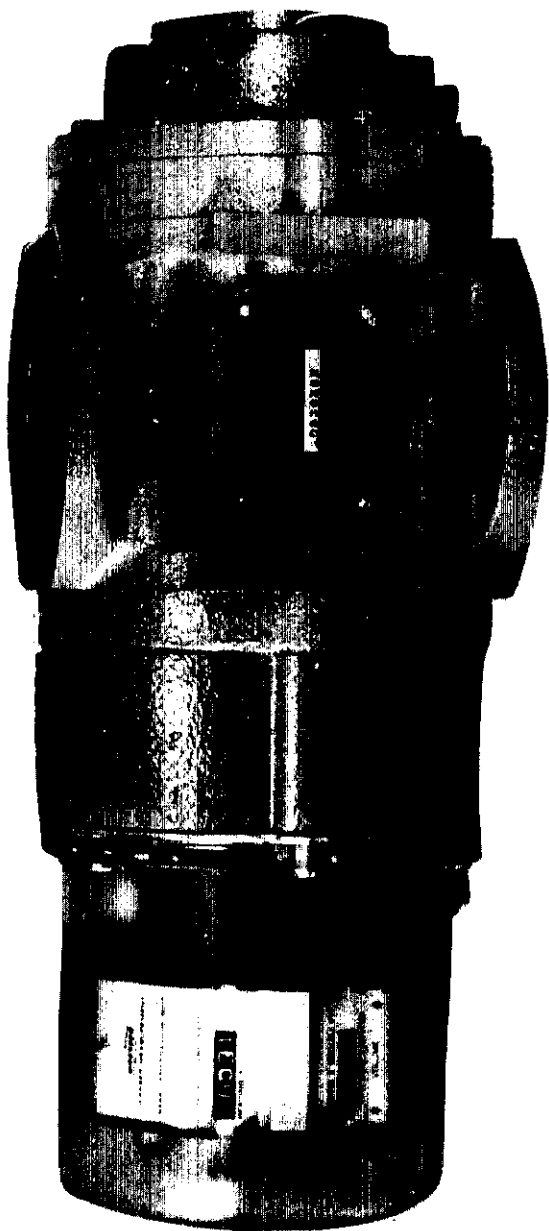



In vertical lines the flow through the meter must always be downward. The oil level sight gauges are interchangeable and their proper location depends on the mounting position of the meter. The manufacturer recommends that the meter out-of-level shall not exceed 1/16 of an inch per foot in any direction. The level can be checked in two directions at one of the pipe flanges, at the machined stacking pads on the meter body, or at the piping for 1.5M size meter.

The meters are designed for direct in-the-line mounting, requiring no additional means of direct support. The manufacturer's suggested installation requirements for the top and side inlet mounting are shown on two sketches. It should be noted that the manufacturer recommends the use of a uniform pipe size in the vicinity of the meter.

The manufacturer warns that these meters are not suitable for metering acetylene or oxygen because some of the construction materials used are not compatible with these gases. In addition, their use for handling sewage gases is specifically not approved because of the corrosion and liquid entrainment.

All meters accepted for service shall be effectively sealed to ensure that no access can be gained to the temperature compensating mechanism or meters registration.

Each meter shall have a nameplate, which includes the following information:

- (1) Manufacturer's name or trade mark
- (2) Model designation
- (3) Rated capacity of the meter
- (4) Maximum pressure rating
- (5) Serial number of the meter.

For field test procedure and other data refer to Technical Gas Circular No. G-71/1.

Apart from the provision of temperature compensation the basic design features of the T-C meters are similar to those of Roots-Meters previously approved under Circulars G-26, G-26-1 and G-26-2.

It must be noted particularly that these meters are APPROVED FOR USE ON LOW PRESSURES ONLY, that is at pressures of approximately seven ounces or less.

Approval granted to:

Dresser Measurement Division  
Dresser Industries Canada Limited,  
Toronto, Ontario.

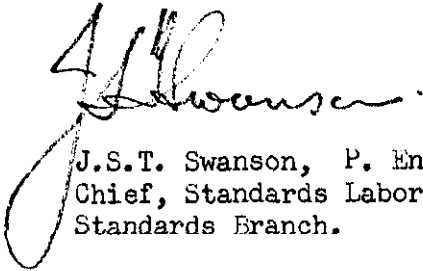
  
J.S.T. Swanson, P. Eng.,  
Chief, Standards Laboratory,  
Standards Branch.

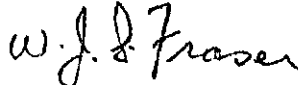
  
W.J.S. Fraser,  
Chief, Electricity and Gas Division,  
Standards Branch.