

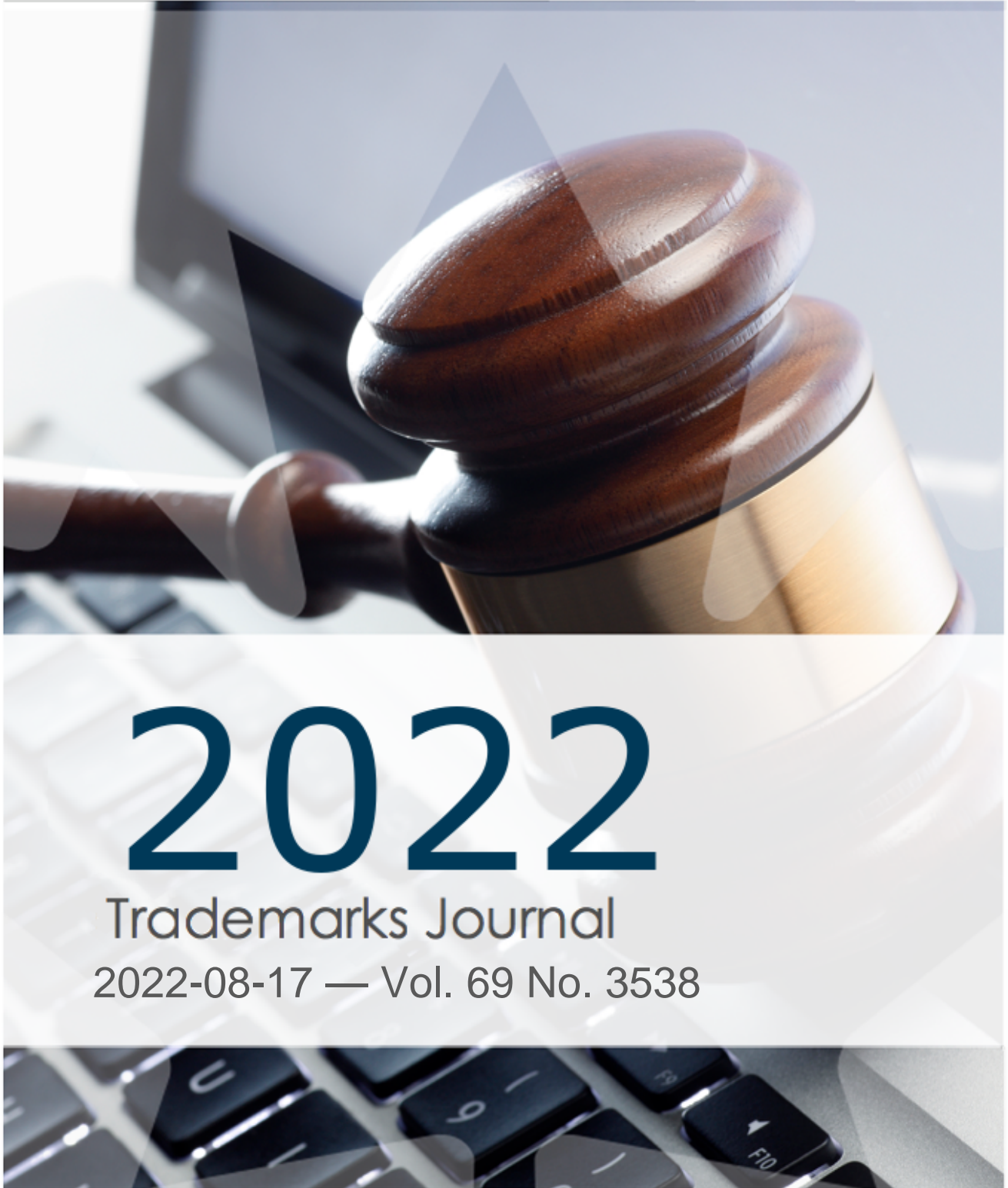

Innovation, Sciences et
Développement économique Canada
Office de la propriété intellectuelle du Canada

Innovation, Science and
Economic Development Canada
Canadian Intellectual Property Office



2022

Trademarks Journal

2022-08-17 — Vol. 69 No. 3538

Canada

Trademarks Journal

Vol. 69 No. 3538

General Information

The *Trademarks Journal* (the “*Journal*”) is published on the website of the Canadian Intellectual Property Office (<http://cipo.gc.ca>). The *Journal* lists trademark applications advertised under subsection 37(1) of the *Trademarks Act* (the “*Act*”), public notices of prohibited marks under section 9 of the *Act*, statements of the Minister in respect of geographical indications under subsection 11.12(2) of the *Act*, as well as erratums to previous volumes.

Electronic *Trademarks Journal*

The *Journal* is available in PDF format and can be downloaded free of charge and viewed and printed with Adobe Acrobat Reader. The *Journal* is also available in a printable HTML format as an alternate official version that contains a search function to narrow and customize the content. The electronic form of the *Journal* is the official version.

Official Languages

The *Journal* is available in English and French. The details displayed for each application are based on the language of the application. If the language of the application is English, the goods, services, or other text and description appearing in the English version of the *Journal* are in the language filed by the applicant. If the language of the application is French, the goods, services, or other text and description appearing in the English version of the *Journal* have been translated. Any registration resulting from the application will be restricted to these goods or services as described in the language of the application.

Filing Dates

The filing date of each trademark application (including those to extend the statement of goods or services of an existing registration) is shown in the YYYY-MM-DD format.

Nice Classification

Where applicable and required, the *Journal* lists the goods or services of each application grouped according to the classes of the Nice Classification, each group being preceded by the number of the class of the Nice Classification to which that group of goods or services belongs and presented in the order of the classes of the Nice Classification.

Opposition

Any person who has a valid ground of opposition (see section 38 of the *Act* for the grounds of opposition) to any application for registration of a trademark or to any application for registration of a trademark extending the statement of goods or services advertised in this *Journal* may file a statement of opposition with the Registrar of Trademarks within two months from the date of issue of this publication. The prescribed fee must accompany the statement of opposition.

ISSN 0041-0438 (printed)

ISSN 1701-4751 (online)

Table of contents

Advertised applications 5

Applications to extend the statement of goods or services 1564

Public notices under section 9 of the *Trademarks Act* 1569

Advertised applications

Application Number 1,716,921
Language of Application English

Filing Date 2015-02-26

APPLICANT AND AGENT DETAILS**Applicant**

Novolex Holdings, LLC
101 East Carolina Avenue
Hartsville, SC 29550
UNITED STATES OF AMERICA

Agent

MARKS & CLERK
33 Yonge Street, , Suite 300, Toronto,
ONTARIO, M5E1G4

TRADEMARK DETAILS**DURO****Trademark Type**

Word

Goods**Class 16**

(1) Paper bags, printed paper bags, paper bags for packaging, reusable shopping bags, bags for securing valuables, namely sealable paper bags for currency, coins and cheques not for use in manufacturing.

(2) Paper bags, printed paper bags, paper bags for packaging not for use in manufacturing.

Claims

Priority Filing Date: August 28, 2014, Country or Office: UNITED STATES OF AMERICA,
Application No: 86/380,305 in association with the same kind of goods

Application Number 1,740,594
Language of Application English

Filing Date 2015-08-06

APPLICANT AND AGENT DETAILS

Applicant

Cavalier Agrow Ltd.
PO Box 110
Meota
SASKATCHEWAN
S0M1X0

Agent

FURMAN IP LAW & STRATEGY PC
300 - 1914 HAMILTON STREET, REGINA,
SASKATCHEWAN, S4P3N6

TRADEMARK DETAILS

iFARM

Trademark Type

Word

Services

Class 44

Agronomy consulting services, namely the collection, use and analysis of agricultural soil samples as well as satellite imagery for the purpose of agricultural crop management and variable rate fertility

Application Number 1,813,415
Language of Application English

Filing Date 2016-12-09

APPLICANT AND AGENT DETAILS

Applicant

United Rentals, Inc.
100 First Stamford Place
Suite 700
Stamford, CT 06902
UNITED STATES OF AMERICA

Agent

FASKEN MARTINEAU DUMOULIN LLP
333 BAY STREET, SUITE 2400, BAY
ADELAIDE CENTRE, BOX 20, TORONTO,
ONTARIO, M5H2T6

TRADEMARK DETAILS

UR

Trademark Type

Word

Goods

Class 07

(1) Heavy and industrial equipment and tools, namely, electric pumps, sludge pumps, silt pumps and suction pumps, electricity generators, work platforms in the nature of boom lifts and scissors lifts, compaction equipment, namely, earth compaction machines, ride-on drum rollers, walk behind drum rollers, remote rollers, roller walk behind pads, vibration plate compactors, earth moving machines, skid steer machines, air compressors, cranes, trenching machines, bulldozers, concrete forming machines, surface preparation and remediation tools in the nature of abrasive blasters, concrete grinders, concrete scarifiers, and power scrubbers, air and electrically powered tools, namely, air compressors, rock splitters, rock breakers, impact wrenches, after coolers and filters being parts of air powered tools, concrete and masonry equipment, namely, power buggies to move concrete, walk-behind saws to cut concrete, power lawn and landscaping equipment, namely, wood chippers, stump grinders, and straw blowers, multi-purpose pressure washers, electric welding machines

Class 09

(2) Transformers, electrical testing, and power distribution equipment, namely, multi-panel circuit breakers, load banks, electrical meters and power distribution panels, highway safety and traffic control products, namely, electronically controlled luminous message signs

Class 12

(3) Vehicles, namely, buses, vans, dump trucks, cargo trailers, automobiles, utility trucks, pick-up trucks, service trucks, stake bed trucks, water trucks, motorized golf carts, and water tank trailers

Services

Class 35

(1) Retail store services featuring new and used rental equipment, namely heavy and industrial equipment, namely, electric pumps, sludge pumps, silt pumps and suction pumps, generators, boom lifts, scissors lifts, forklifts, compaction rollers, backhoes, excavators, skid steers, air compressors, trailers, trucks, compaction equipment, cranes, generators, trenchers, bulldozers

and concrete forming equipment, general tools and equipment, namely, hand tools and gardening and landscaping equipment, special events equipment, namely, tents, tables and chairs and parts thereof; tool and equipment management services, namely, inventory control for equipment, namely heavy and industrial equipment, namely, electric pumps, sludge pumps, silt pumps and suction pumps, generators, boom lifts, scissors lifts, forklifts, compaction rollers, backhoes, excavators, skid steers, air compressors, trailers, trucks, compaction equipment, cranes, trenchers, bulldozers and concrete forming equipment and tool

Class 37

(2) Rental of construction and industrial equipment, namely, electric pumps, sludge pumps, silt pumps and suction pumps, generators, forklifts, backhoes, cranes, bulldozers, aerial lifts, compressors, scaffolding, surface preparation and remediation tools; rental of general tools and equipment, namely, hand tools, air tools, electrician tools, power tools, concrete and masonry equipment, namely, power buggies to move concrete, walk-behind saws to cut concrete; rental of trench safety and shoring equipment; rental services, namely, selecting construction equipment, supplies and tools for others based on the consumers' needs and coordinating the rental thereof; maintenance and repair services, namely, visually tracking the condition and performance of rental vehicles and rental construction equipment, supplies and tools for others and providing the necessary maintenance and repair services therefor, including the refueling thereof when needed; construction project management services; rental of fences; fueling services for others for construction equipment, vehicles, generators and tools and monitoring fuel consumption thereof and refueling construction equipment, vehicles, generators and tools when necessary; mobile fueling services, namely, providing location-based fueling equipment, namely vehicles and generators for fueling vehicles; rental of construction and industrial equipment, namely, fuel tanks

Class 39

(3) Rental of vehicles and trailers; rental and leasing of drones for mapping, aerial photography and delivery services; rental services, namely, selecting rental vehicles for others based on the consumers' needs and coordinating the rental thereof; providing delivery services for rental vehicles and rental construction equipment, supplies and tools; transport and delivery of fuels for location-based fueling of equipment, namely vehicles and generators

Class 40

(4) Rental of construction and industrial equipment, namely, power equipment in the nature of power transfer switches and transformers; assembly of rental vehicles and rental construction equipment, supplies and tools for others

Class 41

(5) Training in the use and operation of equipment and tools, namely, electric pumps, sludge pumps, silt pumps and suction pumps, generators, forklifts, backhoes, cranes, bulldozers, aerial lifts, compressors, scaffolding, surface preparation and remediation tools, hand tools, gardening and landscaping equipment, air tools, electrician tools, power tools, concrete and masonry equipment; training in the field of industrial safety

Class 42

(6) Rental of surveying equipment; rental of computer application software to fleet managers to enable them to track the location of equipment, vehicles and tools; rental of computer application software to fleet managers to enable them to track the maintenance of equipment, vehicles and tools; rental of computer application software to entities and individuals to enable them to track various assets, namely, electric pumps, sludge pumps, silt pumps and suction pumps, generators, forklifts, backhoes, cranes, bulldozers, aerial lifts, compressors, scaffolding, surface preparation

and remediation tools, hand tools, gardening and landscaping equipment, air tools, electrician tools, power tools, concrete and masonry equipment; providing online, non-downloadable mobile computer software applications for inventory management of equipment, vehicles and tools, namely, electric pumps, sludge pumps, silt pumps and suction pumps, generators, forklifts, backhoes, cranes, bulldozers, aerial lifts, compressors, scaffolding, surface preparation and remediation tools, hand tools, gardening and landscaping equipment, air tools, electrician tools, power tools, concrete and masonry equipment; providing online, non-downloadable mobile computer software applications relating to the rental of equipment, vehicles and tools, namely electric pumps, sludge pumps, silt pumps and suction pumps, generators, forklifts, backhoes, cranes, bulldozers, aerial lifts, compressors, scaffolding, surface preparation and remediation tools, hand tools, gardening and landscaping equipment, air tools, electrician tools, power tools, concrete and masonry equipment

Class 43

(7) Rental of special event equipment, namely, tents, tables and chairs

Class 44

(8) Rental of gardening and landscaping equipment

Claims

Priority Filing Date: December 02, 2016, Country or Office: UNITED STATES OF AMERICA, Application No: 87/255,142 in association with the same kind of goods and in association with the same kind of services (1), (2), (3), (4), (5), (6), (7)

Application Number 1,819,028
Language of Application English

Filing Date 2017-01-20

APPLICANT AND AGENT DETAILS

Applicant

Intuit Inc.
2535 Garcia Avenue
Mountain View, CA 94043
UNITED STATES OF AMERICA

Agent

FASKEN MARTINEAU DUMOULIN LLP
Tour de la Bourse, Suite 3500, P.O. box 242,
800, Place Victoria, Montréal, QUEBEC,
H4Z1E9

TRADEMARK DETAILS

Trademark Type

Design

Visual Representation



Goods

Class 09

Computer software for tax planning, tax calculation, and tax return preparation and filing; computer software for processing tax payments; computer software for organizing, tracking and reporting tax deductible expenses; computer software for tracking charitable donations and calculating charitable tax deductions and fair market value of goods and services; computer software for customers to directly deposit tax refunds into accounts at financial institutions; computer software to pre-populate tax forms with tax data from online accounts held at financial institutions; computer software that enables multiple users to screen share and communicate by chat, telephone, instant messaging and email via an interactive website for use in providing remote technical support of software and remote technical support of online computer services, namely non-downloadable software for tax planning, tax calculation, and tax return preparation and filing; computer software that enables multiple users to screen share and communicate by chat, telephone, instant messaging and email via an interactive website for use in providing assistance with regard to accounting and taxes; computer software for use in providing assistance with regard to accounting and taxes; computer software that enables communication by chat, telephone, instant messaging and email via an interactive website between tax professionals and customers; computer software

that enables users to capture, upload, download, store, organize, view, create, edit, encrypt, send and share receipts, documents, information, tax information, digital images, photographs, and electronic messages, all in the field of tax planning, tax return preparation, and tax return filing; computer software that enables communication by chat, telephone, instant messaging and email via an interactive website between technical support representatives and customers; computer software for use in providing technical support in the form of troubleshooting computer software problems; computer software for use in troubleshooting problems with computer software and online computer services, namely non-downloadable software for tax planning, tax calculation, and tax return preparation and filing, via telephone, online chat, e-mail, video and other means, namely social media and instant messaging; mobile application software for tax planning, tax calculation, and tax return preparation and filing, processing tax payments, and for organizing, tracking and reporting tax-deductible expenses; computer software that enables users to photograph and upload documents.

Services

Class 35

(1) Consultation, advisory, analysis, and assistance services with regard to accounting and taxes; consultation and advisory services in the fields of accounting and taxes, including tax calculation, tax planning, tax return preparation, tax refund, tax management, preparation of tax forms, and tax return filing; providing tax and tax preparation management information and consultation; providing information concerning accounting, taxes, tax calculation, tax planning, tax return preparation, tax refunds, tax management, preparation of tax forms, and tax returns filing; providing tax analysis and calculation in the nature of accounting and assessment, planning, preparation, and filing services; providing advice, analysis and opinions to consumers in the fields of tax return preparation and tax planning; providing tax calculation, planning, preparation, and filing services; electronic tax filing services; consultation, advisory, analysis, and assistance services with regard to aggregating wage, interest, dividend, and other income and expense information from a wide variety of sources for tax related purposes; consultation, advisory, analysis, and assistance services with regard to organizing, tracking and reporting tax deductible expenses; providing information on the health insurance marketplace and shopping for health insurance via a website; providing information in the fields of health plan options; providing information via an interactive website in the field of healthcare subsidies for users to understand the eligibility criteria and determine their eligibility for healthcare subsidies; Providing information in the fields of tax planning, tax return preparation, and tax return filing via a website.

Class 36

(2) Consultation, advisory, analysis, and assistance services with regard to tax payment management; providing analysis and calculation of tax payments; provision of information concerning tax payment management; on-line financial services enabling users to directly deposit tax refunds into accounts at financial institutions; transaction processing services for financial institutions and consumers, namely, processing of debit card transactions and tax refunds; transaction processing services for deposits of tax refunds; online debit, pre-paid, stored-value and reloadable card balance and account tracking services accessed via secure internet financial platforms; providing online financial calculators; providing online financial calculators for healthcare subsidies; providing information in the fields of health insurance, health insurance exchanges and health insurance subsidies; providing information in the field of medical care subsidies; debit account and refund account services; debit account and refund account services featuring a computer readable card; providing health care information in the field of medical care subsidies.

Class 38

(3) Providing an online forum for users to post and respond to questions in the fields of tax, healthcare, health insurance legislation, immigration reform, legislation, business, and current events; providing an online forum for users to post and respond to questions in the field of tax; providing online forums, online chat rooms and electronic bulletin boards for transmission of messages among users in the fields of tax and healthcare; providing on-line chat rooms and electronic bulletin boards for transmission of messages among users via electronic communications network in the fields of tax, healthcare, health insurance legislation, immigration reform, legislation, business, business development and current events; providing on-line forums for transmission of messages via electronic communications network among users of mobile phones and mobile communication devices, namely smartphones, video phones, tablet computers, portable personal computers; providing electronic bulletin boards for transmission of messages via electronic communications network among users in the fields of tax and healthcare; providing on-line forums in the field of financial software and financial online services namely tax, healthcare insurance and healthcare plans; providing Internet access services for users to electronically publish and electronically share user-generated content in the field of tax and healthcare via mobile phones and mobile communication devices, namely smartphones, video phones, tablet computers, portable personal computers; providing an interactive online forum for users to contribute and edit digital content, namely documents, information, tax information, digital images, photographs and electronic messages all in the fields of tax, and accounting, and business development; providing online forums and online chat rooms for users to ask and answer each other's questions, and to ask questions and receive answers from a computer system, in the fields of business management computer software, accounting computer software, business management, financial management, tax, healthcare insurance and healthcare insurance legislation; providing electronic bulletin boards for transmission of messages among users in the fields of business management computer software, accounting computer software, business management, financial management, tax, healthcare insurance and healthcare insurance legislation; providing an interactive online forum for users to post and respond to questions in the fields of health insurance subsidies, medical care subsidies, health care plan options and the Affordable Care Act; online interactive information services, namely providing access to an interactive website for answering questions about health insurance benefits and requirements; providing interactive online chat forums for registered users to participate in discussions with technical support representatives; Providing access to a website that enables users to capture, upload, download, store, organize, view, create, edit, encrypt, send and share receipts, documents, information, tax information, digital images, photographs, and electronic messages, all in the fields of tax planning, tax return preparation, and tax return filing; providing access to customized on-line web pages featuring on-line web links to other websites all in the fields of health insurance, health insurance exchanges, health insurance legislation, health insurance subsidies, health plan options and the Affordable Care Act; providing access to a website featuring online links to the websites of others in the fields of health insurance, health insurance exchanges, health insurance legislation, health insurance subsidies, health plan options and the Affordable Care Act; providing access to a website featuring news, information, commentary, and infographics in the fields of health insurance, health insurance exchanges, health insurance legislation, health insurance subsidies, health plan options and the Affordable Care Act; providing access to a website featuring information on health insurance, health insurance exchanges, health insurance legislation, health insurance subsidies, health plan options and the Affordable Care Act in the form of videos, webinars, and other educational materials, namely online educational publications in the nature of articles in the field of health insurance, health insurance exchanges, health insurance legislation, health insurance subsidies, health plan options and the Affordable Care Act; providing access to customized on-line web pages featuring on-line web links to other

websites in the field of financial information relating to medical care subsidies; providing access to a website featuring non-downloadable videos in the fields of tax, tax planning, tax preparation, and medical care subsidies; providing access to customized on-line web pages and data feeds featuring on-line web links to other websites in the field of health care information relating to medical care subsidies.

Class 41

(4) Publication of editorials all in the fields of tax, tax planning, tax preparation, health insurance, health insurance exchanges, health insurance legislation, health insurance subsidies, medical care subsidies, health plan options and the Affordable Care Act; providing online articles in the fields of tax, tax planning, tax preparation, health insurance, health insurance exchanges, health insurance legislation, health insurance subsidies, medical care subsidies, health plan options and the Affordable Care Act; providing infographics and online videos in the fields of tax, tax planning, tax preparation health insurance, health insurance exchanges, health insurance legislation, health insurance subsidies, medical care subsidies, health plan options and the Affordable Care Act; education services, namely, providing non-downloadable webinars in the fields of tax, tax planning, tax preparation and medical care subsidies; providing news and commentary, all in the fields of health insurance, health insurance exchanges, health insurance legislation, health insurance subsidies, health plan options and the Affordable Care Act; providing financial news and commentary, in the field of medical care subsidies; providing health care news and health care commentary, in the field of medical care subsidies; providing news to consumers in the fields of tax return preparation and tax planning.

Class 42

(5) Providing temporary use of on-line non-downloadable software for tax planning, tax calculation, and tax return preparation and filing; software as a service (SAAS) services featuring software for tax planning, tax calculation, and tax return preparation and filing, processing tax payments, and for organizing, tracking and reporting tax-deductible expenses; providing temporary use of online non-downloadable software for processing tax payments; providing temporary use of online non-downloadable computer software for organizing, tracking and reporting tax deductible expenses; providing temporary use of online, non-downloadable mobile application software for tax planning, tax calculation, and tax return preparation and filing, processing tax payments, and for organizing, tracking and reporting tax-deductible expenses; providing temporary use of non-downloadable software for online financial services for accounting, bookkeeping, online financial and business transaction processing management, financial and business transaction management, tax preparation and tax planning, business process management, financial planning, investment management, managing online accounts held at financial institutions, electronic bill payment, tax payment processing services, cash management and electronic funds transfer; providing temporary use of non-downloadable software for customers to directly deposit tax refunds into accounts at financial institutions; providing temporary use of non-downloadable software to pre-populate tax forms with tax data from online accounts held at financial institutions; providing temporary use of online non-downloadable software for determining eligibility for healthcare subsidies and for calculating healthcare subsidies; providing temporary use of on-line non-downloadable software that enables multiple users to screen share and communicate by chat, telephone, instant messaging and email via an interactive website for use in providing remote technical support of software and remote technical support of online computer services, namely non-downloadable software for tax planning, tax calculation, and tax return preparation and filing; providing temporary use of online non-downloadable software that enables multiple users to screen share and communicate by chat, telephone, instant messaging and email via an interactive website for use in providing assistance with regard to accounting and taxes; providing temporary

use of on-line non-downloadable software that enables users to capture, upload, download, store, organize, view, create, edit, encrypt, send and share receipts, documents, information, tax information, digital images, photographs, and electronic messages, all in the field of tax planning, tax return preparation, and tax return filing; providing temporary use of online non-downloadable software for use in providing assistance with regard to accounting and taxes; providing temporary use of on-line non-downloadable software that enables communication by chat, telephone, instant messaging and email via an interactive website between tax professionals and customers; providing temporary use of on-line non-downloadable software that enables communication by chat, telephone, instant messaging and email via an interactive website between technical support representatives and customers; providing temporary use of on-line non-downloadable software for use in providing technical support of software; providing temporary use of on-line non-downloadable software for use in troubleshooting problems with computer software and online computer services, namely non-downloadable software for tax planning, tax calculation, and tax return preparation and filing, via telephone, online chat, e-mail, video and other means, namely social media and instant messaging; hosting interactive online blogs and online chat forums for registered users to participate in discussions with technical support representatives; hosting a website that prompts users with personalized instructions based on real time analysis of the user's question structure and semantics, in the fields of business management, finance, tax and healthcare; platform as a service (PAAS) featuring computer software platforms that assist users in rephrasing questions using personalized tips to guide users, in the fields of computer software, business management, finance, tax and healthcare; platform as a service (PAAS) featuring computer software platforms to assist users for calculating eligibility for healthcare subsidies; hosting a website featuring an online community for registered users to participate in discussions in the fields of tax, health insurance, health insurance exchanges, health insurance legislation, health insurance subsidies, medical care subsidies, health plan options and the Affordable Care Act; technical support services, namely, troubleshooting problems with computer software and online computer services, namely non-downloadable software for tax planning, tax calculation, and tax return preparation and filing, via telephone, e-mail and other means, namely online chat, social media and instant messaging; providing temporary use of online, non-downloadable mobile application software for tax planning, tax calculation, and tax return preparation and filing, processing tax payments, and for organizing, tracking and reporting tax-deductible expense; hosting a website featuring information on the health insurance marketplace and shopping for health insurance via a website; hosting an interactive website for answering questions about health insurance benefits and requirements; Hosting a website that enables users to capture, upload, download, store, organize, view, create, edit, encrypt, send and share receipts, documents, information, tax information, digital images, photographs, and electronic messages, all in the fields of tax planning, tax return preparation, and tax return filing; hosting a website featuring financial news, information, commentary, and infographics in the field of medical care subsidies; hosting a website featuring online links to the websites of others in the field of financial information relating to medical care subsidies; hosting a website featuring non-downloadable videos in the fields of tax, tax planning, tax preparation, and medical care subsidies; hosting a website featuring health care news, health care information, health care commentary, and health care infographics in the field of medical care subsidies; hosting a website featuring online links to the websites of others in the field of health care information relating to medical care subsidies; providing interactive online blogs forums for registered users to participate in discussions with technical support.

Claims

Priority Filing Date: July 21, 2016, Country or Office: UNITED STATES OF AMERICA, Application No: 87112356 in association with the same kind of goods and in association with the same kind of services

Application Number 1,824,825
Language of Application English

Filing Date 2017-02-27

APPLICANT AND AGENT DETAILS

Applicant

FOAMCORE MOULDINGS INC.
A9-210 GLENDALE AVE
STE 206
ST. CATHARINES
ONTARIO
L2T3Y6

Agent

MARKS & CLERK
33 Yonge Street, , Suite 300, Toronto,
ONTARIO, M5E1G4

TRADEMARK DETAILS

FOAMCORE

Trademark Type

Word

Goods

Class 08

(1) Hand tools for applying plaster, stucco and concrete

Class 19

(2) Interior and exterior mouldings, decorative columns, cornices, flat stock, keystones, corbels, sills, bands and trim (the foregoing being made from expanded polystyrene with plaster, stucco and concrete coatings), all for interior walls and building exteriors; Plaster, stucco, and concrete; Fibreglass mesh (lath) for use as a support and reinforcement structure for plaster, stucco and concrete

Services

Class 35

(1) Wholesale and retail sale of hand tools for applying plaster, stucco and concrete, interior and exterior mouldings, decorative columns, cornices, flat stock, keystones, corbels, sills, bands and trim (the foregoing being made from expanded polystyrene with plaster, stucco and concrete coatings), plaster, stucco, concrete, and fibreglass mesh (lath) for use as a support and reinforcement structure for plaster, stucco and concrete

Class 40

(2) Manufacture of interior and exterior mouldings, decorative columns, cornices, flat stock, keystones, corbels, sills, bands and trim, all for interior walls and building exteriors to the order and specification of others; Custom design of interior and exterior mouldings, decorative columns, cornices, flat stock, keystones, corbels, sills, bands and trim, all for interior walls and building exteriors

Application Number 1,825,541
Language of Application English

Filing Date 2017-03-02

APPLICANT AND AGENT DETAILS

Applicant
INTUIT INC.
A CORPORATION OF DELAWARE
2535 GARCIA AVENUE
MOUNTAIN VIEW, CA 94043
UNITED STATES OF AMERICA

Agent
FASKEN MARTINEAU DUMOULIN LLP
Tour de la Bourse, Suite 3500, P.O. box 242,
800, Place Victoria, Montréal, QUEBEC,
H4Z1E9

TRADEMARK DETAILS

TURBO

Trademark Type
Word

Goods

Class 09

Computer software for tax planning, tax calculation, and tax return preparation and filing; computer software for processing tax payments; computer software for organizing, tracking and reporting tax deductible expenses; computer software for tracking charitable donations and calculating charitable tax deductions and fair market value of goods and services; computer software for customers to directly deposit tax refunds into accounts at financial institutions; computer software to pre-populate tax forms with tax data from online banking accounts; computer software that enables multiple users to screen share and communicate via an interactive website for use in providing remote technical support of software and remote technical support of online computer services namely non-downloadable software for accounting, financial planning, financial management, tax planning, tax calculation, and tax return preparation and filing; computer software that enables multiple users to screen share and communicate via an interactive website for use in providing assistance with regard to accounting, financial planning, financial management, and taxes; computer software for use in providing assistance with regard to accounting and taxes, namely to verify income, obtain credit scores, monitor credit reports, and calculate debt-to-income ratio; computer software that enables communication by chat, telephone, instant messaging, video chat, video conference and email via an interactive website between tax professionals and customers; computer software that enables users to capture, upload, download, store, organize, view, create, edit, encrypt, send and share receipts, documents, information, tax information, digital images, photographs, and electronic messages, all in the fields of tax planning, tax return preparation, tax return filing, personal and small business accounting, financial management, and generating and submitting applications for financial services; computer software that enables communication by chat, telephone, instant messaging, video chat, video conference and email via an interactive website between technical support representatives and customers; computer software for use in providing technical support in the fields of tax return preparation, tax return filing, personal and small business accounting, financial management, and generating and submitting applications for financial services; computer software for use in troubleshooting problems with tax preparation, computer software and online computer services via telephone, online chat, e-mail, video and other means, namely social media and instant messaging; mobile

application software for tax planning, tax calculation, and tax return preparation and filing, processing tax payments, personal and small business accounting, financial management, generating and submitting applications for financial services and for organizing, tracking and reporting tax-deductible, personal and small business expenses; computer software that enables users to photograph and upload documents; computer software that enables communication by chat, telephone, instant messaging, video chat, video conference and email via an interactive website between consumers and third-party financial services providers; computer software for use in providing automated personal and small business financial management services; computer software for use in financial asset allocation and management, and sector analysis in the field of financial investments; computer software for consumers to create a unified financial profile for themselves, their businesses and their families; computer software for use by consumers and small businesses to aggregate, access, view, manipulate and share financial records from multiple accounts in a single location.

Services

Class 35

(1) Consultation, advisory, analysis, and assistance services with regard to personal and small business accounting and taxes; consultation and advisory services in the fields of personal and small business accounting and taxes, including tax calculation, tax planning, tax return preparation, tax refund, tax management, preparation of tax forms, and tax return filing; providing tax and tax preparation management information and consultation; providing information concerning personal and small business accounting, taxes, tax calculation, tax planning, tax return preparation, tax refunds, tax management, preparation of tax forms, and tax returns filing; providing tax analysis and calculation in the nature of personal and small business accounting and assessment, planning, preparation, and filing services; providing advice, analysis, news, and opinions to consumers in the fields of tax return preparation and tax planning; providing tax calculation, planning, preparation, and filing services; electronic tax filing services; consultation, advisory, analysis, and assistance services with regard to aggregating wage, interest, dividend, and other income and expense information from a wide variety of sources for tax related purposes; consultation, advisory, analysis, and assistance services with regard to organizing, tracking and reporting tax deductible expenses.

Class 36

(2) Consultation, advisory, analysis, and assistance services with regard to tax payment management; providing analysis and calculation of tax payments; provision of information concerning tax payment management; on-line financial services enabling users to directly deposit tax refunds into accounts at financial institutions; debit account and refund account services for the payment and deposit of tax refunds; transaction processing services for financial institutions and consumers, namely, processing of debit card transactions and tax refunds; transaction processing services for deposits of tax refunds; online debit, prepaid, stored-value and reloadable card balance and account tracking services related thereto accessed via secure internet financial platforms; providing online financial calculators; financial management services via global computer networks; online refinancing of educational student debt and other debt obligations; providing online financial analysis and consultations that enables consumers to optimise interest and fees for financial and card accounts held at financial institutions; providing information to consumers in the fields of personal and small business financial management; connecting consumers to third party offers for financial services in the field of tax and healthcare via an interactive website; providing business information services to consumers and small businesses that enable such consumers and small businesses to optimise interest and fees for financial

accounts and credit card accounts; financial risk scoring and modeling services; providing financial history, payment history, loan and debt burden information to consumers; providing consumers with insights into how they compare against others like them in the fields of finance, financial investments, financial valuations, and the financial aspects of retirement; providing aggregated and anonymized financial data in the fields of personal, business and commercial transactions to others for economic and financial trend analysis; providing financial data analysis and financial advice in the fields of tax and personal and commercial transactions; consulting and information services concerning optimizing interest and minimizing fees for financial and card based accounts held at financial institutions.

Class 38

(3) Providing an online forum for users to post and respond to questions in the fields of tax; exchange of messages consisting of questions and responses to questions via Internet forums; electronic exchange of messages using chatrooms and Internet forums and providing electronic bulletin boards for transmission of messages among computer users; providing on-line chat rooms and electronic bulletin boards for transmission of messages via electronic communications network among users in the fields of tax and healthcare; providing on-line forums for transmission of messages via electronic communications network among users of mobile phones and mobile communication devices, namely smartphones, video phones, tablet computers, portable personal computers; providing electronic bulletin boards for transmission of messages among users in the field of general interest; providing on-line forums in the fields of financial planning software, financial management software, online financial planning services and online financial management services.

Class 41

(4) Publication of editorial content all in the fields of tax preparation, tax planning and tax filing; providing online articles in the fields of tax preparation, tax planning and tax filing; providing infographics and online videos in the fields of tax preparation, tax planning and tax filing; Publication of editorial content all in the fields of health care subsidies.

Class 42

(5) Providing temporary use of on-line non-downloadable software for tax planning, tax calculation, and tax return preparation and filing; software as a service (SAAS) services featuring software for tax planning, tax calculation, and tax return preparation and filing, processing tax payments, and for organizing, tracking and reporting tax-deductible expenses; providing temporary use of online non-downloadable software for processing tax payments; providing temporary use of online non-downloadable software for organizing, tracking and reporting tax deductible expenses; providing temporary use of online, non-downloadable mobile application software for tax planning, tax calculation, and tax return preparation and filing, processing tax payments, and for organizing, tracking and reporting tax-deductible expenses; providing temporary use of non-downloadable software for customers to directly deposit tax refunds into accounts at financial institutions; providing temporary use of non-downloadable software to pre-populate tax forms with tax data from online banking accounts; providing temporary use of online non-downloadable software for determining eligibility for healthcare subsidies and for calculating healthcare subsidies; providing temporary use of on-line non-downloadable software that enables multiple users to screen share and communicate via an interactive website for use in providing remote technical support of software and remote technical support in the fields of tax return preparation, tax return filing, personal and small business accounting, financial management, and generating and submitting applications for financial services; providing temporary use of online non-downloadable software that enables multiple users to screen share and communicate via an interactive website for use in

providing assistance with regard to accounting and taxes; providing temporary use of on-line non-downloadable software that enables users to capture, upload, download, store, organize, view, create, edit, encrypt, send and share receipts, documents, information, tax information, digital images, photographs, and electronic messages, all in the fields of tax planning, tax return preparation, tax return filing, personal and small business accounting, financial management, and generating and submitting applications for financial services; providing temporary use of online non-downloadable software for use in providing assistance with regard to accounting and taxes; providing temporary use of on-line non-downloadable software that enables communication via an interactive website between tax professionals and customers; providing temporary use of on-line non-downloadable software that enables communication via an interactive website between technical support representatives and customers; providing temporary use of on-line non-downloadable software for use in providing technical support; providing temporary use of on-line non-downloadable software for use in troubleshooting problems with tax preparation, computer software and online computer services, namely non-downloadable software for accounting, financial planning, financial management, tax planning, tax calculation, and tax return preparation and filing, via telephone, online chat, e-mail, video and other means, namely social media and instant messaging; hosting a website and non-downloadable computer software featuring interface system technology that prompts users with personalized instructions based on real time analysis of the user's question structure and semantics, in the fields of computer software, business management, finance, healthcare and tax; hosting a website featuring technology that advises users on re-phrasing questions using personalized tips to guide users, in the fields of computer software, business management, finance, healthcare and tax; hosting a website featuring technology that enables users to post and respond to questions in the fields of tax and healthcare subsidies; hosting a website featuring technology that enables users to contribute and edit digital content, namely documents, information, tax information, digital images, photographs and electronic messages all in the field of tax; hosting a website featuring technology that enables users to determine eligibility for healthcare subsidies; hosting a website featuring technology that enables users to calculate healthcare subsidies; hosting a website featuring an online community for registered users to participate in discussions in the fields of tax and healthcare subsidies; technical support services, namely, troubleshooting problems with computer software and online computer services, namely non-downloadable software for accounting, financial planning, financial management, tax planning, tax calculation, and tax return preparation and filing, via telephone, e-mail and other means, namely online chat, social media and instant messaging; providing temporary use of non-downloadable software for use in connecting via an interactive website consumers to third-party offers for financial planning and financial management services; providing temporary use of non-downloadable software for use in providing automated personal and small business financial management services; providing temporary use of non-downloadable software for use in asset allocation and sector analysis; providing temporary use of non-downloadable software for consumers to create a unified financial profile for themselves, their businesses and their families; providing temporary use of non-downloadable software for use by consumers and small businesses to aggregate, access, view and manipulate financial records from multiple accounts in a single location; platform as a service (PAAS) featuring computer software platforms for use by consumers and small businesses to aggregate, access, view, manipulate and share financial records from multiple accounts in a single location; fraud protection services, namely computer security services in the nature of threat analysis for protecting personal and financial information, electronic monitoring of credit card activity to detect fraud via the internet, identity theft and fraud protection services, namely, internet surveillance of financial and personal information, theft protection services, namely, fraud prevention in the form of personal information and financial identity monitoring, fraud resolution assistance, namely, providing advice and consultation in the

field of identity theft; identity protection and restoration services, namely, electronic monitoring of personal identification information to detect identity theft via the Internet; hosting a website featuring online links to the websites of others in the field of financial information in the field of medical care subsidies; hosting a website enabling consumers to communicate with third-party financial services providers offering lower interest rates and fees for financial accounts and credit card accounts; hosting a website that provides consumers with automated recommendations on choosing third-party financial services providers in the fields of financial investments, financial valuations, financial aspects of retirement, financial forecasting, financial management, financial planning, financial risk assessment, credit and debit control and financing of loans; hosting a website featuring an online community for registered users to publish and share user-generated content in the fields of finance, accounting, loans, credit reports, tax and healthcare accessible via mobile phones and mobile communication devices, namely smartphones, video phones, tablet computers, portable personal computers; hosting a website through which users contribute and edit digital content, namely documents, information, financial and tax data, images, photographs and electronic messages all in the fields of tax, accounting, and personal and business financial management; hosting a website featuring non-downloadable videos in the fields of tax preparation, tax planning, tax filing and health care subsidies.

Application Number 1,825,543
Language of Application English

Filing Date 2017-03-02

APPLICANT AND AGENT DETAILS

Applicant

INTUIT INC.
A CORPORATION OF DELAWARE
2535 GARCIA AVENUE
MOUNTAIN VIEW, CA 94043
UNITED STATES OF AMERICA

Agent

FASKEN MARTINEAU DUMOULIN LLP
Tour de la Bourse, Suite 3500, P.O. box 242,
800, Place Victoria, Montréal, QUEBEC,
H4Z1E9

TRADEMARK DETAILS

Trademark Type

Design

Visual Representation



Goods

Class 09

Computer software for tax planning, tax calculation, and tax return preparation and filing; computer software for processing tax payments; computer software for organizing, tracking and reporting tax deductible expenses; computer software for tracking charitable donations and calculating charitable tax deductions and fair market value of goods and services; computer software for customers to directly deposit tax refunds into accounts at financial institutions; computer software to pre-populate tax forms with tax data from online banking accounts; computer software that enables multiple users to screen share and communicate via an interactive website for use in providing remote technical support of software and remote technical support of online computer services namely non-downloadable software for accounting, financial planning, financial management, tax planning, tax calculation, and tax return preparation and filing; computer software that enables multiple users to screen share and communicate via an interactive website for use in providing assistance with regard to accounting, financial planning, financial management, and taxes; computer software for use in providing assistance with regard to accounting and taxes, namely to verify income, obtain credit scores, monitor credit reports, and calculate debt-to-income ratio; Computer software that enables communication by chat, telephone, instant messaging, video chat, video conference and email via an interactive website between tax professionals and customers; computer software that enables users to capture, upload, download, store, organize, view, create, edit, encrypt, send and share receipts, documents, information, tax information, digital images, photographs, and electronic messages, all in the fields of tax planning, tax return preparation, tax return filing, personal and small business accounting, financial management, and generating and submitting applications for financial services; computer software that enables communication by chat, telephone, instant messaging, video chat, video conference and email via an interactive website between technical support representatives and customers;

computer software for use in providing technical support in the fields of tax return preparation, tax return filing, personal and small business accounting, financial management, and generating and submitting applications for financial services; computer software for use in troubleshooting problems with tax preparation, computer software and online computer services via telephone, online chat, e-mail, video and other means, namely social media and instant messaging; mobile application software for tax planning, tax calculation, and tax return preparation and filing, processing tax payments, personal and small business accounting, financial management, generating and submitting applications for financial services and for organizing, tracking and reporting tax-deductible, personal and small business expenses; computer software that enables users to photograph and upload documents; computer software that enables communication by chat, telephone, instant messaging, video chat, video conference and email via an interactive website between consumers and third-party financial services providers; computer software for use in providing automated personal and small business financial management services; computer software for use in financial asset allocation and management, and sector analysis in the field of financial investments; computer software for consumers to create a unified financial profile for themselves, their businesses and their families; computer software for use by consumers and small businesses to aggregate, access, view, manipulate and share financial records from multiple accounts in a single location.

Services

Class 35

(1) Consultation, advisory, analysis, and assistance services with regard to personal and small business accounting and taxes; consultation and advisory services in the fields of personal and small business accounting and taxes, including tax calculation, tax planning, tax return preparation, tax refund, tax management, preparation of tax forms, and tax return filing; providing tax and tax preparation management information and consultation; providing information concerning personal and small business accounting, taxes, tax calculation, tax planning, tax return preparation, tax refunds, tax management, preparation of tax forms, and tax returns filing; providing tax analysis and calculation in the nature of personal and small business accounting and assessment, planning, preparation, and filing services; providing advice, analysis, news, and opinions to consumers in the fields of tax return preparation and tax planning; providing tax calculation, planning, preparation, and filing services; electronic tax filing services; consultation, advisory, analysis, and assistance services with regard to aggregating wage, interest, dividend, and other income and expense information from a wide variety of sources for tax related purposes; consultation, advisory, analysis, and assistance services with regard to organizing, tracking and reporting tax deductible expenses.

Class 36

(2) Consultation, advisory, analysis, and assistance services with regard to tax payment management; providing analysis and calculation of tax payments; provision of information concerning tax payment management; on-line financial services enabling users to directly deposit tax refunds into accounts at financial institutions; debit account and refund account services for the payment and deposit of tax refunds; transaction processing services for financial institutions and consumers, namely, processing of debit card transactions and tax refunds; transaction processing services for deposits of tax refunds; online debit, pre-paid, stored-value and reloadable card balance and account tracking services related thereto accessed via secure internet financial platforms; providing online financial calculators; financial management services via global computer networks; online refinancing of educational student debt and other debt obligations; providing online financial analysis and consultations that enables consumers to optimise interest

and fees for financial and card accounts held at financial institutions; providing information to consumers in the fields of personal and small business financial management; connecting consumers to third party offers for financial services in the field of tax and healthcare via an interactive website; providing business information services to consumers and small businesses that enable such consumers and small businesses to optimise interest and fees for financial accounts and credit card accounts; financial risk scoring and modeling services; providing financial history, payment history, loan and debt burden information to consumers; providing consumers with insights into how they compare against others like them in the fields of finance, financial investments, financial valuations, and the financial aspects of retirement; providing aggregated and anonymized financial data in the fields of personal, business and commercial transactions to others for economic and financial trend analysis; providing financial data analysis and financial advice in the fields of tax and personal and commercial transactions; consulting and information services concerning optimizing interest and minimizing fees for financial and card based accounts held at financial institutions.

Class 38

(3) Providing an online forum for users to post and respond to questions in the fields of tax; exchange of messages consisting of questions and responses to questions via Internet forums; electronic exchange of messages using chatrooms and Internet forums and providing electronic bulletin boards for transmission of messages among computer users; providing on-line chat rooms and electronic bulletin boards for transmission of messages via electronic communications network among users in the fields of tax and healthcare; providing on-line forums for transmission of messages via electronic communications network among users of mobile phones and mobile communication devices, namely smartphones, video phones, tablets computers, portable personal computers; providing electronic bulletin boards for transmission of messages among users in the field of general interest; providing on-line forums in the fields of financial planning software, financial management software, online financial planning services and online financial management services.

Class 41

(4) Publication of editorial content all in the fields of tax preparation, tax planning and tax filing; providing online articles in the fields of tax preparation, tax planning and tax filing; providing infographics and online videos in the fields of tax preparation, tax planning and tax filing; Publication of editorial content all in the fields of health care subsidies.

Class 42

(5) Providing temporary use of on-line non-downloadable software for tax planning, tax calculation, and tax return preparation and filing; software as a service (SAAS) services featuring software for tax planning, tax calculation, and tax return preparation and filing, processing tax payments, and for organizing, tracking and reporting tax-deductible expenses; providing temporary use of online non-downloadable software for processing tax payments; providing temporary use of online non-downloadable software for organizing, tracking and reporting tax deductible expenses; providing temporary use of online, non-downloadable mobile application software for tax planning, tax calculation, and tax return preparation and filing, processing tax payments, and for organizing, tracking and reporting tax-deductible expenses; providing temporary use of non-downloadable software for customers to directly deposit tax refunds into accounts at financial institutions; providing temporary use of non-downloadable software to pre-populate tax forms with tax data from online banking accounts; providing temporary use of online non-downloadable software for determining eligibility for healthcare subsidies and for calculating healthcare subsidies; providing temporary use of on-line non-downloadable software that enables multiple users to screen share

and communicate via an interactive website for use in providing remote technical support of software and remote technical support in the fields of tax return preparation, tax return filing, personal and small business accounting, financial management, and generating and submitting applications for financial services; providing temporary use of online non-downloadable software that enables multiple users to screen share and communicate via an interactive website for use in providing assistance with regard to accounting and taxes; providing temporary use of online non-downloadable software that enables users to capture, upload, download, store, organize, view, create, edit, encrypt, send and share receipts, documents, information, tax information, digital images, photographs, and electronic messages, all in the fields of tax planning, tax return preparation, tax return filing, personal and small business accounting, financial management, and generating and submitting applications for financial services; providing temporary use of online non-downloadable software for use in providing assistance with regard to accounting and taxes; providing temporary use of on-line non-downloadable software that enables communication via an interactive website between tax professionals and customers; providing temporary use of on-line non-downloadable software that enables communication via an interactive website between technical support representatives and customers; providing temporary use of on-line non-downloadable software for use in providing technical support; providing temporary use of on-line non-downloadable software for use in troubleshooting problems with tax preparation, computer software and online computer services namely non-downloadable software for accounting, financial planning, financial management, tax planning, tax calculation, and tax return preparation and filing, via telephone, online chat, e-mail, video and other means, namely social media and instant messaging; hosting a website and non-downloadable computer software featuring interface system technology that prompts users with personalized instructions based on real time analysis of the user's question structure and semantics, in the fields of computer software, business management, finance, healthcare and tax; hosting a website featuring technology that advises users on re-phrasing questions using personalized tips to guide users, in the fields of computer software, business management, finance, healthcare and tax; hosting a website featuring technology that enables users to post and respond to questions in the fields of tax and healthcare subsidies; hosting a website featuring technology that enables users to contribute and edit digital content, namely documents, information, tax information, digital images, photographs and electronic messages all in the field of tax; hosting a website featuring technology that enables users to determine eligibility for healthcare subsidies; hosting a website featuring technology that enables users to calculate healthcare subsidies; hosting a website featuring an online community for registered users to participate in discussions in the fields of tax and healthcare subsidies; technical support services, namely, troubleshooting problems with computer software and online computer services, namely non-downloadable software for accounting, financial planning, financial management, tax planning, tax calculation, and tax return preparation and filing via telephone, e-mail and other means, namely online chat, social media and instant messaging; providing temporary use of non-downloadable software for use in connecting via an interactive website consumers to third-party offers for financial planning and financial management services; providing temporary use of non-downloadable software for use in providing automated personal and small business financial management services; providing temporary use of non-downloadable software for use in asset allocation and sector analysis; providing temporary use of non-downloadable software for consumers to create a unified financial profile for themselves, their businesses and their families; providing temporary use of non-downloadable software for use by consumers and small businesses to aggregate, access, view and manipulate financial records from multiple accounts in a single location; platform as a service (PAAS) featuring computer software platforms for use by consumers and small businesses to aggregate, access, view, manipulate and share financial records from multiple accounts in a single location; fraud protection services, namely

computer security services in the nature of threat analysis for protecting personal and financial information, electronic monitoring of credit card activity to detect fraud via the internet, identity theft and fraud protection services, namely, internet surveillance of financial and personal information, theft protection services, namely, fraud prevention in the form of personal information and financial identity monitoring, fraud resolution assistance, namely, providing advice and consultation in the field of identity theft; identity protection and restoration services, namely, electronic monitoring of personal identification information to detect identity theft via the Internet; hosting a website featuring online links to the websites of others in the field of financial information in the field of medical care subsidies; hosting a website enabling consumers to communicate with third-party financial services providers offering lower interest rates and fees for financial accounts and credit card accounts; hosting a website that provides consumers with automated recommendations on choosing third-party financial services providers in the fields of financial investments, financial valuations, financial aspects of retirement, financial forecasting, financial management, financial planning, financial risk assessment, credit and debit control and financing of loans; hosting a website featuring an online community for registered users to publish and share user-generated content in the fields of finance, accounting, loans, credit reports, tax and healthcare accessible via mobile phones and mobile communication devices, namely smartphones, video phones, tablets computers, portable personal computers; hosting a website featuring non-downloadable videos in the fields of tax preparation, tax planning, tax filing and health care subsidies; hosting a website through which users contribute and edit digital content, namely documents, information, financial and tax data, images, photographs and electronic messages all in the fields of tax, accounting, and personal and business financial management.

Application Number 1,836,830
Language of Application English

Filing Date 2017-05-10

APPLICANT AND AGENT DETAILS

Applicant

SOTI INC.
6975 Creditview Rd., Unit 4
Mississauga
ONTARIO
L5N8E9

Agent

NORTON ROSE FULBRIGHT CANADA LLP/S.
E.N.C.R.L.,S.R.L.
1, Place Ville Marie, Suite 2500, Montreal,
QUEBEC, H3B1R1

TRADEMARK DETAILS

SOTI ONE

Trademark Type

Word

Goods

Class 09

Downloadable computer software platform that integrates and manages mobile application and development software to support business operations, namely, computer operating system security, indoor positioning systems, occupancy-aware control systems, management, and tracking of data transmitted over wireless data networks between a stationary computer system and multiple mobile computers; downloadable computer software that manages smart devices that exhibit some properties of ubiquitous computing, namely smartphones, smart scanners, computer tablets, smart activity trackers, smart speakers, smart watches, personal digital assistants, voice activated assistants, smart printers, smart package delivery boxes, smart locks, and smart thermostats and sensors namely temperature sensors, weight sensors, motion sensors, light sensors, moisture sensors, projected capacitive touch sensors, and biochip sensors; technical support services software, namely troubleshooting of computer hardware and software problems, computer software that performs data analysis and provides predictive outcome data for use in managing smart devices; computer software which mimics human behavior by learning various data patterns and insights for use in managing smart devices; smart device and smart appliance computer communications software, namely computer communications software that remotely analyzes, communicates with and controls the functions of smart sensors contained in smart devices, namely, smart printers and smart appliances, namely, kitchen appliances, personal care devices namely electric vibrating massaging devices, smart mirrors, smart body weight scales, electric hair shaving devices, electric hair trimming devices, hair drying devices, hair curling devices, hair straightening devices, and hair styling devices, HVAC appliances; pet and baby care devices namely smart activity trackers, smart monitors, smart cameras, automatic feeders, digital animal litter boxes, digital temporary pet shelters; elderly and disabled care devices namely smart wheelchairs, smart pill dispensers, fall detection sensors, and smart bed sensor pads.

Services

Class 41

(1) Education and training services in the field of managing smart devices; online publication of computer software technical support guides and tutorials in the field of technical trouble shooting of computer software issues.

Class 45

(2) Licensing of software and intellectual property;

Application Number 1,849,953
Language of Application English

Filing Date 2017-07-28

APPLICANT AND AGENT DETAILS

Applicant

American Lebanese Syrian Associated
Charities, Inc.
501 St. Jude Place
Memphis, TN 38105
UNITED STATES OF AMERICA

Agent

BERESKIN & PARR LLP/S.E.N.C.R.L., S.R.L.
SCOTIA PLAZA, 40 KING STREET WEST,
40th FLOOR, TORONTO, ONTARIO, M5H3Y2

TRADEMARK DETAILS

FINDING CURES. SAVING CHILDREN.

Trademark Type

Standard Characters

Services

Class 36

(1) charitable fundraising

Class 41

(2) providing educational lectures, seminars, conferences and workshops in the fields of medicine and medical research and providing instructional materials in connection therewith; training of medical and surgical professionals, clinicians, health workers and scientists in the field of biomedical research; providing medical and scientific research library services; providing on-line library services; providing on-line lectures, seminars and tutorial services in the fields of medicine, health care services for treating cancer and blood disorders, hospital services, medical clinics, medical care, diagnosis and analysis services relating to patient treatment, medical examination services, nursing care, home nursing aid services, physical rehabilitation, nutrition counseling, dental care and treatment and medical science; providing educational information in the field of medical practice and research

(3) educational services, namely conducting educational lectures, seminars, and conferences in the fields of medicine and research and providing instructional materials in connection therewith; training of clinicians and scientists in the field of biomedical research; dissemination of educational materials of others in the field of medicine, namely providing medical and scientific research library services, providing on-line library services, providing educational information in the field of medical practice and research, providing educational information in the field of the prevention and treatment of catastrophic diseases in children, primarily pediatric cancers and blood disorders

Class 44

(4) hospital services and medical care, diagnosis and analysis services relating to patient treatment; medical clinics; medical and surgical diagnostic services; medical examination services; medical evaluation services for patients receiving rehabilitation and medical care for purposes of guiding treatment and assessing effectiveness; providing medical information in the fields of health care services for treating cancer and blood disorders, hospital services, medical clinics, medical care, diagnosis and analysis services relating to patient treatment, medical examination services,

nursing care, home nursing aid services, physical rehabilitation, nutrition counseling, dental care and treatment and medical science; providing information in the field of catastrophic diseases in children, primarily pediatric cancers via the Internet; nursing care; home nursing aid services; physical rehabilitation; nutrition counseling; and dental care and treatment

(5) hospital services and medical care, diagnosis and analysis services relating to patient treatment; medical clinics; medical evaluation services for patients receiving rehabilitation for purposes of guiding treatment and assessing effectiveness; providing medical information in the fields of health care services for treating cancer and blood disorders, hospital services, medical clinics, medical care, diagnosis and analysis services relating to patient treatment, medical examination services, nursing care, home nursing aid services, physical rehabilitation, nutrition counseling, dental care and treatment and medical science; providing information in the field of catastrophic disease in children, primarily pediatric cancers via the Internet; nursing care; home nursing aid services; physical rehabilitation; nutrition counseling; and dentist and dental hygienist services

Application Number 1,850,738
Language of Application English

Filing Date 2017-08-02

APPLICANT AND AGENT DETAILS

Applicant

Czarnowski Display Service, Inc.
2287 South Blue Island Ave.
Chicago, IL 60608
UNITED STATES OF AMERICA

Agent

GOWLING WLG (CANADA) LLP
TD Canada Trust Tower, Suite 1600, 421 -7
Avenue SW, Calgary, ALBERTA, T2P4K9

TRADEMARK DETAILS

Trademark Type

Design

Visual Representation



Services

Class 39

(1) Supply chain logistics services consisting of the storage, delivery and transportation of portable non-metal structures for others by air, land and water and the storage of portable non-metal structures for others

Class 40

(2) Custom fabrication and production of tents and temporary portable modular metal and modular nonmetal tent structures

Class 42

(3) Planning, engineering, and architectural design of temporary portable building structures; creative product development of temporary structures

Class 43

(4) Rental of tents; rental of temporary accommodation in the nature of portable modular structures; rental of a kit comprised of temporary and custom designed portable modular metal and modular non-metal tent structures with flooring and scaffolding therefor for experiential activations, festivals, and sporting events

Claims

Priority Filing Date: June 16, 2017, Country or Office: UNITED STATES OF AMERICA, Application No: 87/493436 in association with the same kind of services

Application Number 1,852,671
Language of Application English

Filing Date 2017-08-16

APPLICANT AND AGENT DETAILS

Applicant

Jayco, Inc.
903 S. Main Street P.O. Box 460
Middlebury, IN 46540
UNITED STATES OF AMERICA

Agent

MARKS & CLERK
33 Yonge Street, , Suite 300, Toronto,
ONTARIO, M5E1G4

TRADEMARK DETAILS

QWEST

Trademark Type

Word

Authorisation For Use

Consent from Quest University Canada is of record.

Goods

Class 12

Recreational vehicles, namely, motor homes including residential amenities, with the intended purpose of being for recreational use.

Claims

Priority Filing Date: August 14, 2017, Country or Office: UNITED STATES OF AMERICA,
Application No: 87568129 in association with the same kind of goods

Application Number 1,853,142
Language of Application English

Filing Date 2017-08-18

APPLICANT AND AGENT DETAILS

Applicant

Ontario Association of Home Inspectors
205-1515 Matheson Blvd E
Mississauga
ONTARIO
L4W2P5

Agent

PERLEY-ROBERTSON, HILL & MCDUGALL
LLP
1400 - 340 ALBERT STREET, OTTAWA,
ONTARIO, K1R0A5

TRADEMARK DETAILS

Registered Home Inspector-OAHI

Trademark Type

Word

Services

Class 37

(1) Home inspector services; home and property inspector services; association services for promoting the interests of home and property inspectors; services related to the operation of a professional association of home and property inspectors, namely, education, public relations, membership admission, maintenance of public registry of members and membership level and status, credential assessment, development and maintenance of standards of practice, development and maintenance of a code of ethics, and member discipline, all in relation to home and property inspection services

Class 41

(2) Publication and distribution of newsletters and brochures relating to home and property inspection services; education services, namely seminars, conferences and training sessions relating to home and property inspection services; promoting public awareness in relation to home and property inspection services; providing information relating to home inspection services via an Internet website

Application Number 1,853,144
Language of Application English

Filing Date 2017-08-18

APPLICANT AND AGENT DETAILS

Applicant

Ontario Association of Home Inspectors
205-1515 Matheson Blvd E
Mississauga
ONTARIO
L4W2P5

Agent

PERLEY-ROBERTSON, HILL & MCDUGALL
LLP
1400 - 340 ALBERT STREET, OTTAWA,
ONTARIO, K1R0A5

TRADEMARK DETAILS

OAH I Registered Home Inspector

Trademark Type

Word

Services

Class 37

(1) Home inspector services; home and property inspector services; association services for promoting the interests of home and property inspectors; services related to the operation of a professional association of home and property inspectors, namely, education, public relations, membership admission, maintenance of public registry of members and membership level and status, credential assessment, development and maintenance of standards of practice, development and maintenance of a code of ethics, and member discipline, all in relation to home and property inspection services

Class 41

(2) publication and distribution of newsletters and brochures relating to home and property inspection services; education services, namely seminars, conferences and training sessions relating to home and property inspection services; promoting public awareness in relation to home and property inspection services; providing information relating to home inspection services via an Internet website

Application Number 1,860,364
Language of Application English

Filing Date 2017-09-29

APPLICANT AND AGENT DETAILS

Applicant

Praemo Inc.
4 Wesleyan Crt
Ancaster
ONTARIO
L9G5C5

Agent

MILLER THOMSON LLP
ACCELERATOR BUILDING, 295 HAGEY
BLVD., SUITE 300, WATERLOO, ONTARIO,
N2L6R5

TRADEMARK DETAILS

RAZOR

Trademark Type

Word

Goods

Class 09

Downloadable computer software for data automation and collection service using proprietary software to evaluate, analyze and collect statistical production data for oil and gas field operations; computer software for database management; downloadable computer software for data mining; downloadable computer software for monitoring of computer systems for security purposes; computer software for use in connection with a network of vehicles, and buildings which are embedded with electronics, software, sensors and network connectivity; computer software for electronic monitoring and reporting of physical properties of industrial assets

Services

Class 42

Industrial asset monitoring services, namely, computer systems monitoring services, monitoring of computer systems by remote access, and monitoring of computer systems to detect breakdowns; computer security consultancy; computer software consulting; consultancy in the design and development of computer hardware; consultation services relating to computer software; Software as a service (SaaS) services and platform as a service (PaaS) services, all of the foregoing featuring computer software for use in connection with a network of vehicles, and buildings which are embedded with electronics, software, sensors and network connectivity

Application Number 1,866,160
Language of Application English

Filing Date 2017-11-03

APPLICANT AND AGENT DETAILS

Applicant

Registered Nurses' Association of Ontario
500-4211 Yonge Street
Toronto
ONTARIO
M2P2A9

Agent

MARKS & CLERK
33 Yonge Street, , Suite 300, Toronto,
ONTARIO, M5E1G4

TRADEMARK DETAILS

Trademark Type

Design

Visual Representation



Goods

Class 09

(1) Downloadable recordings of webinars in the field of patient care, career development, leadership skills development, business networking, social networking, professional networking, mentorship for healthcare practitioners, and financial management.

(2) Downloadable electronic brochures, magazines, periodical publications, document portfolios, newsletters, informational pamphlets, articles, papers providing information in the field of patient care, career development, leadership skills development, business networking, social networking, professional networking, mentorship and financial management.

Class 16

(3) Printed brochures, magazines, periodical publications, document portfolios, newsletters, informational pamphlets, articles, letters and papers providing information and news in the field of patient care, career development, leadership skills development, business networking, social networking, professional networking, mentorship and financial management.

Services

Class 35

(1) Providing information via a website in the field of career development, leadership skills development, business networking, professional networking, and mentorship for health care practitioners; advertising services, namely advertising events and information of the goods and services of others on a website; Association services for promoting the interests of healthcare professionals, healthcare administrators and nursing students in the fields of patient care, career development, leadership skills development, professional and business networking, professional and business mentorship, and financial management of healthcare facilities; consulting services in the field of career development, leadership skills development, business networking, professional networking for healthcare practitioners.

Class 36

(2) Financial management of healthcare facilities; educational services, namely the provision of scholarships, bursaries, awards, and grants; consulting services in the field of financial management.

(3) Providing information via a website in the field of financial management of healthcare facilities.

Class 41

(4) Organization and conducting conferences, webinars, seminars, meetings, networking events, and classes in the field of patient care, career development, leadership skills development, business networking, professional networking, mentorship of healthcare practitioners, and financial management of healthcare facilities; educational services, namely, awards and fellowships in the field of patient care, career development, leadership skills development, business networking, professional networking, mentorship of healthcare practitioners, and financial management of healthcare facilities.

(5) Providing information via a website in the field of mentorship for health care practitioners; consulting services in the field of mentorship of healthcare practitioners.

Class 44

(6) Consulting services in the field of patient care; providing information in the field of patient care via a website.

Class 45

(7) Organization and conducting conferences, webinars, seminars, meetings, networking events, and classes in the field of social networking; educational services, namely, awards and fellowships in the field of social networking.; Providing information via a website in the field of social networking.

(8) Providing information via a website in the field of social networking.

Application Number 1,866,755
Language of Application English

Filing Date 2017-11-07

APPLICANT AND AGENT DETAILS

Applicant

Canadian Association of Insolvency and
Restructuring Professionals
277 Wellington Street West
Toronto
ONTARIO
M5V3H2

Agent

GOODMANS LLP
ATTN: INTELLECTUAL PROPERTY GROUP,
BAY ADELAIDE CENTRE, 333 BAY STREET,
SUITE 3400, TORONTO, ONTARIO, M5H2S7

TRADEMARK DETAILS

Trademark Type

Design

Visual Representation

CAIRP

Rebuilding Success • Rétablir le succès

Services

Class 35

(1) Association services promoting the interests of its members being trustees and other persons involved in the practice of insolvency administration, business reviews, corporate restructuring, the turnaround of underperforming businesses and related advisory services, business reviews, corporate restructuring, the turnaround of underperforming businesses and related advisory services; advocacy services to promote the services of its members, business reviews, corporate restructuring, the turnaround of underperforming businesses and related advisory services and the public interest related to it; association services representing the views and common interests of insolvency and restructuring professionals with respect to legislation and policy; services of establishing and promoting cooperation among insolvency and restructuring professionals in connection with the work of trustees, receivers, managers, agents, liquidators, and monitors involved in the practice of insolvency administration, business reviews, corporate restructuring and the turnaround of underperforming businesses.

Class 45

(2) Services of establishing and promoting professional standards of practice for its members in connection with the work of trustees, receivers, managers, agents, liquidators, monitors and others involved in the practice of insolvency administration, business reviews, corporate restructuring and the turnaround of underperforming businesses in Canada; services of regulating the discipline and professional conduct of its members.

Application Number 1,867,357
Language of Application English

Filing Date 2017-11-10

APPLICANT AND AGENT DETAILS

Applicant

Bolt Threads, Inc.
5858 Horton Street, Suite 400
Emeryville, CA 94608
UNITED STATES OF AMERICA

Agent

RIDOUT & MAYBEE LLP
5500 North Service Road, Suite 101,
Burlington, ONTARIO, L7L6W6

TRADEMARK DETAILS

MICROSILK

Trademark Type

Word

Goods

Class 22

(1) Natural and man-made silk protein fibers and filaments for use in the manufacture of fabrics, textiles, yarns, and carpets, Synthetic fibers and filaments for use in the manufacture of fabrics, textiles, yarns, and carpets, Yarn fibers, Fibers in the nature of upholstery filling, namely, cushioning not of rubber, plastic or paper in the nature of stuffing and feathers for stuffing, all of the foregoing made in whole and in significant part of silk, spider silk, engineered silk and engineered spider silk

Class 23

(2) Yarn, Mixed spun threads, Silk yarn, Spider silk yarn, Yarns for making textiles, apparel and home furnishings, Synthetic yarn, Customizable yarns, threads, and semi-synthetic fiber yarn and thread being chemically treated natural fiber yarn, Natural fiber yarn and thread, all of the foregoing made in whole and in significant part of silk, spider silk, engineered silk and engineered spider silk; Natural yarns made in whole and in significant part of spider silk; Natural protein fiber yarn and thread, natural protein yarns, customizable yarns, and fiber yarn and thread made of proteins, all of the foregoing made in whole and in significant part of silk, spider silk, engineered silk and engineered spider silk

Class 24

(3) Natural fabrics made principally of silk, spider silk, and other natural protein-based fiber fabrics made in whole and in significant part of silk, spider silk, engineered spider silk and engineered silk; fabrics made principally of silk, namely engineered spider silk and engineered silk, spider silk, and other natural protein-based fiber fabrics made in whole and significant part of silk, spider silk, engineered spider silk and engineered silk; fabrics made from spider silk, namely engineered spider silk

Class 25

(4) Apparel, namely, athletic wear being shirts, pants, shorts, long underwear, undergarments, hats, socks and scarves, jackets, all of the foregoing made in whole and in significant part of silk, spider silk, engineered silk and engineered spider silk; ready to wear luxury apparel, namely, shirts, jackets, pants, ties, socks, dresses, sweaters and suits, all of the foregoing made in whole

and in significant part of silk, spider silk, engineered silk and engineered spider silk; footwear, namely, shoes, boots, sandals, slippers and flip flops, all of the foregoing made in whole and in part of silk, spider silk, engineered silk and engineered spider silk.

Application Number 1,872,888
Language of Application English

Filing Date 2017-12-13

APPLICANT AND AGENT DETAILS

Applicant
ELECTRICAL AND ELECTRONIC
CONTROLS (EEC) LTD.
17 Stewart Crt
Orangeville
ONTARIO
L9W3Z9

Agent
OLLIP P.C.
Gladwin Business Park, 2212 Gladwin
Crescent, Building B, Unit B4, Ottawa,
ONTARIO, K1B5N1

TRADEMARK DETAILS

Trademark Type
Design

Visual Representation



Goods

Class 09

Industrial motor controls, namely, electric current switches for detecting power issues and protecting power sources, time switches, foot switches, limit switches, safety switches, load break switches, fused disconnect switches used for turning power on and off to protect against short circuit and power surges, solenoid switches, electric contactors, electric relays, thermal overload relays and switching relays; Connectors for electronic circuits; Electronic circuit boards; Electronic conductors for circuit boards; Electronic conductors for integrated circuits; Electronic integrated circuits; Timer switches; Capacitors; Electrical relays and transformers; Electric voltage transformers; Voltage regulators; Voltage surge protectors.

Application Number 1,883,261
Language of Application English

Filing Date 2018-02-14

APPLICANT AND AGENT DETAILS

Applicant

VGW HOLDINGS LIMITED
Level 11, 15-17 William Street
Perth, Western Australia 6000
AUSTRALIA

Agent

KENNETH R. CLARK
(AIRD & BERLIS LLP), BROOKFIELD PLACE,
SUITE 1800, 181 BAY STREET, BOX 754,
TORONTO, ONTARIO, M5J2T9

TRADEMARK DETAILS

SUPER DAZZLING 7's

Trademark Type

Word

Goods

Class 09

Computer software, namely computer software for casino and slots gaming purposes and online casino and slots gaming; downloadable software and downloadable application software featuring casino, slots and sweepstakes games; computer software for sweepstakes gaming; computer software for social gaming, including social sweepstakes gaming; computer software for playing games of chance on any computerised platform, including dedicated gaming consoles, mobile phones, tablets and video based slot machines

Services

Class 38

(1) Providing access to a website featuring on-line games; Providing access to a website featuring on-line portal for the operation and coordination of games, tournaments and leagues for recreational gaming purposes; entertainment services, namely providing online social casino and slots games, sweepstakes and computer games; Providing access to a website featuring online social casino games, namely sweepstakes and lottery services; Providing access to a website featuring downloadable and non-downloadable entertainment games; Providing access to a website featuring entertainment services, namely providing virtual environments in which users can interact through social games for entertainment and gaming purposes; Providing access to a website featuring bonus payout systems involving the playing of virtual gaming machines namely bonus payout systems for gaming machines; Providing access to a website featuring entertainment services, namely, providing virtual environments in which users can interact through social games for recreational, leisure or entertainment purposes, namely providing online social casino and slots games, sweepstakes and computer games

Class 41

(2) Online gaming services, namely providing online social casino and slots games, sweepstakes and computer games; casino services;

Application Number 1,885,910
Language of Application English

Filing Date 2018-03-02

APPLICANT AND AGENT DETAILS

Applicant

Attraqt Limited
3 Waterhouse Square
138 Holborn
London EC1N 2SW
UNITED KINGDOM

Agent

BENNETT JONES LLP
4500 BANKERS HALL EAST, 855 - 2ND
STREET S.W., CALGARY, ALBERTA, T2P4K7

TRADEMARK DETAILS

ATTRAQT

Trademark Type

Word

Goods

Class 09

Computer software for e-commerce, namely e-commerce software to allow users to perform electronic business transactions via a global computer network; computer software for online retail services, namely software for operating an online shop; computer software for collecting data relating to consumers' buying habits; computer software for the administrative processing of orders, namely, software to allow users to electronically process orders in an online shop; computer software for inventory control; computer software for supply chain management, namely, computer software for use in managing and controlling production schedules, shipping schedules, purchase of materials, inventories and accounts; computer software relating to the handling of financial transactions, namely software to allow users to perform financial transactions via a global computer network; computer software for online merchandising, namely software for the presentation of goods and services of others via a global computer network for retail purposes; computer software for the promotion of goods and services of others, namely, computer software for promoting the goods and services of others through advertisements on Internet websites or advertisements provided via a global computer network; computer search engine software; computer software used for providing search engine services; computer e-commerce software for accessing, browsing and searching electronic databases; computer software for creating dynamic websites; computer software for website content management; computer software for website navigation; computer software for testing website performance; computer software for the analysis of business data in the field of e-commerce, online retail stores and merchandising; downloadable computer software for use as an application programming interface (API) in the field of ecommerce, online retail stores and merchandising; computer software for on-line advertising the goods and services of others via electronic media and specifically the internet; computer software for embedding online advertising on websites; computer software for embedding personalized advertising on websites; computer software for designing online advertising on websites; computer software for on-line marketing the goods and services of others; computer software for online price comparison services; computer software for providing online product recommendations, namely,

software for providing online information to users relating to products; applications for mobile devices in the field of e-commerce, namely e-commerce software applications to allow users to perform electronic business transactions via a global computer network.

Services

Class 35

(1) Business merchandising display services for others; online merchandising, namely the presentation of goods and services of others via a global communications network for retail purposes; promotion of goods and services of others on the Internet, namely, promoting the goods and services of others through advertisements on Internet websites or advertisements provided via a global computer network; providing advertising services, namely advertising the goods and services of others; online advertising services, namely advertising the goods and services of others online; provision of space on websites for advertising goods and services; promoting the goods and services of others through advertisements on Internet websites; direct marketing of the goods and services of others; online price comparison services; retail services for computer software, namely, retail sale for computer software; statistical analysis and reporting services for business purposes; advertising and business management consultancy; consultancy services relating to the administrative processing of orders; consultancy services relating to supply chain management; consultancy services relating to e-commerce, namely, provision of information and advisory services relating to e-commerce.

Class 41

(2) Training services in the field of computer software, web design or web development, design and development of dynamic websites, design of search engines, or databases; training services in the field of ecommerce, namely, training services for merchants to utilize e-commerce software applications to allow users to perform electronic business transactions via a global computer network; training services in the field of merchandising, namely, training services for merchants to present their goods and services via a global communications network for retail purposes; training services in strategic planning relating to advertising, promotion, marketing and business; arranging and conducting webinars in the field of computer software, web design or web development, design and development of dynamic websites, design of search engines, or databases; arranging and conducting webinars in the field of e-commerce, namely, arranging and conducting webinars for merchants to utilize e-commerce software applications to allow users to perform electronic business transactions via a global computer network; arranging and conducting webinars in the field of merchandising, namely, training services for merchants to present their goods and services via a global communications network for retail purposes; arranging and conducting webinars in the field of strategic planning relating to advertising, promotion, marketing and business.

Class 42

(3) SaaS for e-commerce, namely e-commerce software as a service to allow users to perform electronic business transactions via a global computer network; SaaS for online retail services, namely software as a service for operating an online shop; providing online non-downloadable software for e-commerce, namely ecommerce online non-downloadable software to allow users to perform electronic business transactions via a global computer network; providing online non-downloadable software for online retail services, namely online non-downloadable software and business management of retail and online retail stores; SaaS for collecting data relating to consumer buying habits; providing online non-downloadable software for collecting data relating to consumer buying habits; SaaS for the administrative processing of orders, namely, software as a service to allow users to electronically process orders in an online shop; SaaS for inventory control; SaaS for supply chain management, namely, software as a service for use in managing

and controlling production schedules, shipping schedules, purchase of materials, inventories and accounts; SaaS relating to the handling of financial transactions, namely software as a service to allow users to perform financial transactions via a global computer network; providing online non-downloadable software for the administrative processing of orders, namely, online non-downloadable software to allow users to electronically process orders in an online shop; providing online non-downloadable software for inventory control; providing online non-downloadable software for supply chain management, namely, providing online non-downloadable software for use in managing and controlling production schedules, shipping schedules, purchase of materials, inventories and accounts; providing online non-downloadable software relating to the handling of financial transactions, namely online non-downloadable software to allow users to perform financial transactions via a global computer network; SaaS for online merchandising, namely SaaS for the presentation of goods and services of others via a global communications network for retail purposes; SaaS for the promotion of goods and services of others, namely, software as a service for promoting the goods and services of others through advertisements on Internet websites or advertisements provided via a global computer network; providing online non-downloadable software for online merchandising, namely, providing online non-downloadable software for the presentation of goods and services of others on communications media via a global communications network for retail purposes; providing online non-downloadable software for the promotion of goods and services of others namely, providing online non-downloadable software for promoting the goods and services of others through advertisements on Internet websites or advertisements provided via a global computer network; SaaS for providing search engine services; SaaS for accessing, browsing and searching electronic databases; providing online non-downloadable software used for providing search engine services; providing online non-downloadable software for accessing, browsing and searching electronic databases; SaaS for creating dynamic websites; SaaS for website content management; SaaS for website navigation; SaaS for testing website performance; providing online non-downloadable software for creating dynamic websites; providing online non-downloadable software for website content management; providing online non-downloadable software for website navigation; providing online non-downloadable software for testing website performance; SaaS for use as an application programming interface (API) in the field of e-commerce, online retail stores and merchandising; providing online non-downloadable software for use as an application programming interface (API) in the field of e-commerce, online retail stores and merchandising; SaaS for advertising the goods and services of others; SaaS for embedding online advertising on websites; SaaS for designing online advertising on websites; online non-downloadable software for advertising the goods and services of others via electronic media and specifically the internet; providing online non-downloadable software for embedding online advertising on websites; providing online non-downloadable software for embedding personalized advertising on websites; providing online non-downloadable software for designing online advertising on websites; SaaS for online price comparison services; providing online non-downloadable software for online price comparison services; design and development of computer software; design and development of computer software for e-commerce; design and development of computer software for merchandising; design and development of computer software for online retail services; design and development of computer software for providing personalized online retail services; design and development of computer software for collecting data relating to consumers in order to provide personalized online retail services; design and development of computer software for optimizing or personalizing customer e-commerce experiences; design and development of computer software for use in communication; design and development of computer software for searching the internet or databases; design and development of computer software for creating, maintaining or testing websites; design and development of computer software for analysis of data; design and

development of computer software for advertising or marketing; design and development of computer software for online price comparison or product recommendation services; hosting e-commerce platforms on the internet; programming of software for e-commerce platforms; search engine design services; providing search engines for the Internet; providing search engines for obtaining data via communications networks; providing search engines for obtaining data from online databases; design and construction of websites; hosting of websites; maintaining websites for others; updating websites for others; providing website content management services for others; consultancy relating to the creation and design of websites for e-commerce; consultancy relating to web content management; consultancy services relating to software used in the field of e-commerce; consultancy relating to software installation and configuration; consultancy relating to software integration; consultancy relating to the integration of software with software for product information management, customer relationship management, enterprise resource planning, web content management, and ecommerce.

Claims

Priority Filing Date: December 05, 2017, Country or Office: UNITED KINGDOM, Application No: UK00003275275 in association with the same kind of goods and in association with the same kind of services

Application Number 1,892,359
Language of Application English

Filing Date 2018-04-06

APPLICANT AND AGENT DETAILS

Applicant

Wood Group UK Limited
15 Justice Mill Lane
Aberdeen AB11 6EQ
UNITED KINGDOM

Agent

GOWLING WLG (CANADA) LLP
SUITE 1600, 1 FIRST CANADIAN PLACE, 100
KING STREET WEST, TORONTO, ONTARIO,
M5X1G5

TRADEMARK DETAILS

Trademark Type

Design

Visual Representation

Goods

Class 01

(1) Chemicals used in industry namely olefins, polymers, monomers, aromatics, alcohols, glycols, ethylene oxide, alkylene oxides, isocyanates, amines, anhydrides, hydrochloric acid, hydrofluoric acid, glycolic acid, acetic acid, formic acid, potassium chloride, sodium chloride, biochemicals for use in the oil and gas, as well as the paper and pulp industries, and facility gases being argon, helium, hydrogen, ethylene oxide, carbon dioxide, oxygen, breathing air, compressed air, acetylene, silane, and waste treatment chemicals for the treatment of biological liquid waste, chemical waste and toxic waste; unprocessed artificial resins; unprocessed plastics; fire extinguishing compositions; tempering and soldering chemicals; preparations for softening and soldering metals; fluids for drilling; chemical additives to drilling muds

Class 06

(2) Common metals and their alloys; metal building materials namely boards, panels, cladding, flashing, partitions, pillars, linings, handrails, slabs, wall tiles, floor tiles, and trims, as well as reinforcing materials of metal for buildings, and specially adapted parts and fittings therefor; transportable buildings of metal namely portable metal office buildings for construction sites, portable levees, portable storage sheds, and specially adapted parts and fittings therefor; materials of metal for railway tracks; non-electric cables and wires of common metal; ironmongery namely small items of metal hardware being screws, nails, nuts, bolts, door and window handles, door and window knobs, door and window pulls, door and window hinges, pipe muffs, fittings of metal for pipes, expansion joints for walls and floors, expansion joints for pipes and ducts; pipes and tubes of metal namely water pipes, sewer pipes, pipes for liquid and gas transfer, pipes for central heating installations, penstock pipes, gutter pipes, drainage pipes, branding tubes for pipelines, and ground tubes; ores; barrels of metal; metal mooring buoys, and specially adapted parts and fittings therefor; capsules of metal for compressed gas, and specially adapted parts and fittings

therefor; metal plates enamelled for coatings; rolled and cast metal building materials namely hot-rolled steel bars, rolled steel, rolled ground tubes of steel, rolled and cast steel, cast iron; rails of metal and other metal materials for railroad, and specially adapted parts and fittings therefor; chains (except driving chains for land vehicles); non electric metal cables and wire; balls of steel; spikes and screws of metal; expansion couplings of metal for pipes and ducts, as well as for walls and floors; drainage fittings for drainage pipes of metal; metal expansion clutches, pipes and cables; draining systems being sewer and discharging pipes and tubes of metal, and specially adapted parts and fittings therefor

Class 07

(3) Machinery and apparatus for generating steam namely industrial steam generators, steam engines for industrial machinery, machine bellows, steam turbines, and specially adapted parts and fittings therefor; machinery and apparatus for use in nuclear power stations namely electricity generators, and specially adapted parts and fittings therefor; machinery and apparatus for the processing of oils, fats or of petroleum and for use in the chemical industry namely agitators, blending machines, calcining machines, disintegrators, emulsifying machines, extracting machines, separating machines, and specially adapted parts and fittings therefor; motors and engines used in industrial applications and specially adapted parts and fittings therefor; valves being parts of machines; machine coupling and transmission components and specially adapted parts and fittings therefor; machines and machine equipment for industry namely generators, steam jet air ejectors, and specially adapted parts and fittings therefor; machine tools namely, rock crushers, impact mills, coal breakers, pulverizers, conveyers, conveyer belts, centrifuges, coalescers being parts of machines, compressors for machines, mixers and blenders and parts therefor, all being for industrial and commercial mining applications; machines and machine equipment for refining petroleum, and specially adapted parts and fittings therefor; machines and machine equipment for processing lubricating oils, and specially adapted parts and fittings therefor; steam condensers, and specially adapted parts and fittings therefor; machines and machine equipment for industrial use, namely centrifugal pumps and vacuum pumps, and specially adapted parts and fittings therefor; machines and machine equipment for industrial use, namely the production of electricity and for the cleaning of flue gas, and specially adapted parts and fittings therefor; machines and machine equipment for generating electricity as a by-product from the incineration of waste, and specially adapted parts and fittings therefor; parts and fitting for industrial installations and apparatus for the processing of oils, fats and petroleum; heat recovery ventilation valves for motors and engines, and specially adapted parts and fittings therefor; industrial hydraulic pressing, rending and solvent extraction installations and apparatus for the processing and recovery of oils, fats and of petroleum, petroleum products and of petroleum derivatives, and specially adapted parts and fittings therefor

Class 09

(4) Scientific, nautical, surveying, telegraphic, photographic, cinematographic and optical instruments namely laboratory flow loop instruments, hydrogen probes, electrical resistance probes, telegraph wires, electrical and optical cables, fibre optic periscopes, fibre optic gas sensors, fibre optic humidity sensors, fibre optic liquid level sensors, fibre optic thermal sensors, fibre optic vibration sensors and specially adapted parts and fittings therefor; weighing, signalling and measuring instruments namely concentration meters, electricity meters, viscosity-gel meters, magnetometers, shearometers, borehole gravity meters, flowmeters, dynamometers, inclinometers, gas meters, water meters, vibration meters, viscometers, porosimeters, gamma ray densitometers, nuclear fluid densimeters, tensiometers, magnetometers, industrial weighing scales for the mining, as well as the oil and gas industries, biofuel chemical weighing scales, luminous beacons for safety or warning purposes, instrumented pigs to record pipeline corrosion, and

pecially adapted parts and fittings therefor; electrical instruments, namely control apparatus being thermostats, electric control panels, electrical control systems for heating and air conditioning systems, electrical controllers for industrial machinery engines and motors, electrical controls for emergency sprinkler systems, electrodynamic apparatus for the remote control of railway points, and parts and fittings therefor; clothing for protection against fire, injury, accident and irradiation; equipment for protection against fire, injury, accident and irradiation, namely fire alarm boxes, fire alarm control panels, fire alarm systems, fire blankets, fire boats, fire buckets, fire escapes, fire hose, fire hose nozzles, fire sprinklers, nets for protection against accidents, and specially adapted parts and fittings therefor; safety clothing for protection against accident and injury; fire extinguishers, and specially adapted parts and fittings therefor; fire detectors and parts and fittings therefor; smoke detectors and parts and fittings therefor; combustion control systems namely pressure, temperature, flame and gas sensors, gaseous analysers, valve configurations; computer software for the operation of reservoir modelling for oil and gas and mining engineering, for oil and gas production support, and for reporting on the maintenance, management and overhaul of industrial gas turbines for the operation of repair services in the field of oil and gas; downloadable electronic periodical publications in the nature of engineering, production support, maintenance management and industrial gas turbine overhaul and repair services in the field of oil and gas; telecommunications apparatus namely power grids, power line carrier terminals, automatic transfer switches, change-over switches for telecommunication apparatus, computer network hubs, switches and routers, masts for wireless aerials, automatic telephone exchangers, two-way radios, telephone sets, headsets, telephone switchboards, telephone terminals, telephone wires, VoIP telephones, and parts and fittings therefor; computer software, hardware and firmware for the collation, input, output, display, analysis, reporting and generation of information and reports for the business management of the mining, gas and oil industries; electrical power supplies and electrical power supply apparatus namely distribution boxes and blocks both for electrical power, electric power converters, power distribution panels, power transformers, power wires, voltage regulators, and parts and fittings therefor; fire and gas detection systems namely fire detectors, alarms for the detection of inflammable gases, carbon dioxide detectors, carbon monoxide detectors, fire and smoke detectors, gas alarms, gas leak detection systems, and parts and fittings therefor; navigation aids, apparatus, instrumentation and systems namely navigation apparatus for marine and land vehicles in the form of on-board computers, gyrocompass, sextants, radars, bearing compass, magnetic compass, beacon lights, speedometers, and parts and fittings therefor; remote monitoring systems and instrumentation namely downloadable software for the management, monitoring, and measurement of oil and gas processing and the management of oil and gas operations and performance, for the monitoring of mineral rights assets for the oil and gas industry, for monitoring the production and flows for gas and oil processing, for the management of environmental information and compliance in the field of national pollutant release obligations, greenhouse gas emissions, and incident management, and for its related analysis and reporting; page party alarm systems being an emergency paging system; oil level sensors; capacitors; artificial intelligence apparatus namely downloadable software for automatic performance analysis, statistical analysis, data analytics and prediction in the field of oil and gas exploration and environmental impact; marking and signaling buoys, navigational buoys, and specially adapted parts and fittings therefor; apparatus for use in nuclear power stations namely cameras and computer operating systems for nuclear power stations, and specially adapted parts and fittings therefor

Class 11

(5) Apparatus for heating, steam generating, refrigerating, drying, ventilating, water supply and sanitary purposes namely boilers for heating installations, boilers for electricity-generating

installations, heating boilers, industrial boilers, waste heat boilers, pipes for heating boilers, heat recovery steam generators, gas, petroleum, biomass and solid-fuel fired heaters, feed water heaters, and steam condensers as part of heating installations, HVAC units, drying apparatus for use in heating, ventilation systems, air conditioning systems and refrigeration systems, water treatment equipment, namely, reverse osmosis and desalination units, and specially adapted parts and fittings therefor; air heat recovery ventilation installations, and specially adapted parts and fittings therefor; counterflow furnace for use in the treatment of waste material, and specially adapted parts and fittings therefor; installations for generating steam and nuclear energy namely nuclear generators, and specially adapted parts and fittings therefor; industrial chemical refining tower installations for the oil and gas industry, and specially adapted parts and fittings therefor; steam generators, and specially adapted parts and fittings therefor; ventilators for heat exchangers, and specially adapted parts and fittings therefor; heat recovery ventilators, and specially adapted parts and fittings therefor; vaporiser recovery units for the oil and gas industry; water heaters; fired heaters, and specially adapted parts and fittings therefor; industrial heaters, and specially adapted parts and fittings therefor; kilns, and specially adapted parts and fittings therefor; rotary kilns (for industrial purposes), and specially adapted parts and fittings therefor; gas condensers other than parts of machines; steam super heaters, and specially adapted parts and fittings therefor; desuperheaters, and specially adapted parts and fittings therefor; desalinators, and specially adapted parts and fittings therefor; air heaters, and specially adapted parts and fittings therefor; warming heaters for feed water for heating boilers, and specially adapted parts and fittings therefor; refrigerating plants for the oil and gas industry; steam generating and condensing columns for the oil and gas industry; desalination units, desalination plants; refuse disposal installations specifically waste-to-energy waste disposal installations namely waste disposal incinerators; air purification installations and equipment namely scrubbers and flue gas cleaning apparatus; heating and cooling apparatus namely feedwater heaters; heat exchangers for the removal of flue gases; burners and boilers namely acid gas burners, thermal incinerators, combustion furnaces, combustion chambers, steam reforming furnaces, waste disposal furnaces, waste disposal incinerators, combustion furnaces for waste fuels, ovens for the treatment of waste; heaters for use in the treatment of waste fuels; chemical, petrochemical, gas and oil fired heaters for industrial purposes; chemical flue gas scrubbing apparatus, and parts and fittings therefor; apparatus for use in nuclear power stations namely nuclear reactors, and specially adapted parts and fittings therefor; heat recovery ventilation units, and specially adapted parts and fittings therefor

Class 12

(6) Unmanned aerial vehicles, unmanned submersible vehicles, autonomous vehicles for seabed inspections; Apparatus for locomotion by land, air or water namely marine vessels in the form of ships, helicopters, photography drones, locomotives, automobiles, trucks

Class 14

(7) Precious metals and their alloys

Class 16

(8) Paper; cardboard; plastic film and containers for packaging; printed instructions manuals for computer software for industrial process design and simulation

Class 17

(9) Crude rubber; gutta-percha; raw and unprocessed gum; asbestos; mica; plastics in extruded form for use in manufacture; insulating materials namely electric, thermal and acoustic insulators, electrical insulation, fibreglass, foam insulation for use in building and construction, foils of metal for building insulation; flexible plastic pipes for conveying natural gas; centrifugal pumps; expansion joints

Class 21

(10) Scouring sponges; articles for cleaning purposes namely brushes for cleaning tanks and containers, cleaning and polishing cloths, pads of metal for cleaning, plastic buckets; steelwool; unworked and semi-worked glass (except glass used in building)

Class 22

(11) Ropes, string, commercial nets, glass fiber netting, polyester plastic netting for packaging goods, awnings, tarpaulins, sails; artificial animal hair for padding and stuffing purposes

Services**Class 35**

(1) Business and management consultancy services in the fields of mechanical and civil engineering, procurement, construction management, business operational support and facility management; business management services for the development of projects from concept to realisation, commissioning and operation, and information and advice in the field of business management for the development of projects from concept to realisation; business services relating to the commissioning of projects in the oil and gas industries, automotive industries, consumer goods, pulp and paper, pharmaceuticals, chemicals and polymers, refineries and petrochemicals, and information and advice in the field of commissioning of projects in the oil and gas industries, automotive industries, consumer goods, pulp and paper, pharmaceuticals, chemicals and polymers, refineries and petrochemicals; business management services to facilitate turnkey operations, and information and advice in the field of business management services to facilitate turnkey operations; business services and business management of facilities for processing of oil and gas, and for industrial plants, and information and advice in the field of business services and business management of facilities for processing of oil and gas and for industrial plants; provision of business efficiency techniques relating to processes and industrial plants, and information and advice in the field of business efficiency techniques relating to processes and industrial plants; provision of business feasibility studies namely studies relating to the connection of facilities to electricity networks, and information and advice in the field of business feasibility studies related to the connection of facilities to electricity networks; supply and demand forecasting and analysis and assessment of product distribution processes for others, and information and advice in the field of supply and demand forecasting and analysis and assessment of product distribution processes for others; purchasing and procurement services in the form of purchasing heavy equipment, and information and advice in the field of purchasing and procurement in the form of purchasing heavy equipment; business administration, and information and advice in the field of business administration; construction cost management, and information and advice in the field of construction cost estimation; cost analysis; strategic business planning, and providing information and advice in the field of strategic business planning; business risk analysis, and providing information and advice in the field of business risk analysis; business advice relating to financial planning and to risk management; business contractor management, business planning, business project scheduling, and providing information and advice in the field of business contractor management, business planning, and business project scheduling; personnel management, and providing information and advice in the field of personnel management; personnel administration support services, and providing information and advice in the field of personnel administration support services; personnel recruitment, screening and placement, and providing information and advice in the field of personnel recruitment, screening and placement; undertaking personnel competence programmes, and providing information and advice in the field of undertaking personnel competence programmes; payroll administration services for others; preparation of payrolls (for others); providing information and advice in the field of payroll

administration and payroll preparation for others; visa permit and work permit administration services, and providing information and advice in the field of visa permit and work permit administration; supply chain management, and providing information and advice in the field of supply chain management; business services relating to technology assessment, business asset optimization and business resource planning, and providing information and advice in the field of business technology assessment, business asset optimization and business resource planning; document preparation and document management namely copying of documents for others, document reproduction, indexing of documents for others, and providing information and advice in the field of business management in the field of documents, and providing information and advice in the field of business management in the field of documents; data management namely business management services relating to information and data compiling and analyzing, and providing information and advice in the field of business management services relating to information and data compiling and analyzing; commissioning of business project feasibility studies, and providing information and advice in the field of commissioning of business project feasibility studies; advisory services relating to business management and business operations; efficiency expert services, namely business management optimisation of plant operations, and providing information and advice in the field of business management optimisation of plant operations; operational business assistance to enterprises, and providing information and advice in the field of operational business assistance to enterprises; business operations management services for logistic services, and providing information and advice in the field of business operations management services for logistic services; document control services, and providing information and advice in the field of document control services; provision of emergency management services, and providing information and advice in the field of provision of emergency management services; taxation consultation advice and consultancy services; provision of business management services for the reduction of costs, improvement of schedules, management of risk, maximisation of safety and delivery of critical project objectives, and providing information and advice in the field of business management services for the reduction of costs, improvement of schedules, management of risk, maximisation of safety and delivery of critical project objectives; survey services, and providing information and advice in the field of survey services; financial cost analysis services; project cost control; business appraisal and selection of licensors and licensor coordination; project validation services namely pre-project business strategic planning

Class 36

(2) Financial feasibility studies, and consulting in the field of financial feasibility studies; financial asset management services, and consulting in the field of financial asset management services; project financing and finance package services namely financial risk management, and consulting in the field of financial risk management; financial investment analysis, and consulting in the field of financial investment analysis; consultancy services relating to finance, namely in relation to the buying and selling of businesses; financial consultancy in the energy sector; financing of energy and engineering projects (other than debt financing), and consulting in the field of financing of energy and engineering projects; funding of projects, and consulting in the field of funding of projects; financial planning of projects, and consulting in the field of financial planning of projects; financial value management, and consulting in the field of financial value management; vendor management services namely brokerage of real estate and consulting in the field of vendor management services namely brokerage of real estate; construction cost estimation services; construction cost estimation services

Class 37

(3) Building, construction, installation, maintenance, repair, cleaning, commissioning being the checking and testing of all industrial plant functions before operations begin, decommissioning

services being the deconstruction of industrial plants at end of lifecycle, all for the oil and gas and renewable energy industries, automotive industry, third-party consumer products industries, pulp and paper industries, pharmaceutical industries, chemical and polymers refineries, in nuclear power plants, in biofuel plants and installations, in renewable energy projects, in industrial facilities namely industrial processing plants and industrial processing plant equipment, and in petrochemical plants and installations, and information, advisory and consultancy services in the field of building, construction, installation, maintenance, repair, cleaning, commissioning being the checking and testing of all industrial plant functions before operations begin, decommissioning services being the deconstruction of industrial plants at end of lifecycle, all for the oil and gas and renewable energy industries, automotive industry, third-party consumer products industries, pulp and paper industries, pharmaceutical industries, chemical and polymers refineries, in nuclear power plants, in biofuel plants and installations, in renewable energy projects, in industrial facilities including namely industrial processing plants and industrial processing plant equipment, and in petrochemical plants and installations; engineering project management relating to the construction, commissioning of industrial and process plants, and information, advisory and consultancy services in the field of engineering project management relating to the construction, commissioning of industrial and process plants; construction project supervision, and information, advisory and consultancy services in the field of construction project supervision; plant and engineering construction supervision services, and information, advisory and consultancy services in the field of plant and engineering construction supervision services; construction of industrial facilities namely gas and oil processing plants and equipment for the production and treatment of gas and oil refinery being sliding vane petroleum pumps, energy facilities for the production of coal, nuclear energy, renewable energy, pharmaceutical products, steam, electricity, flue gas, chemicals, metals, petrochemicals, and natural gas, and information, advisory and consultancy services in the field of construction of industrial facilities namely gas and oil processing plants and equipment for the production and treatment of gas and oil refinery being sliding vane petroleum pumps, energy facilities for the production of coal, nuclear energy, renewable energy, pharmaceutical products, steam, electricity, flue gas, chemicals, metals, petrochemicals, and natural gas; project management relating to the repair of oil and gas exploration, extraction and production installations; construction supervision and building construction supervision services, and information, advisory and consultancy services in the field of construction supervision and building construction supervision services; retrofitting of industrial plants and facilities, and information, advisory and consultancy services in the field of retrofitting of industrial plants and facilities; gas and oil drilling, and information, advisory and consultancy services in the field of gas and oil drilling; mining, and information, advisory and consultancy services in the field of mining; civil engineering construction consultancy, and information, advisory and consultancy services in the field of civil engineering construction consultancy; civil engineering underwater construction services, and information, advisory and consultancy services in the field of civil engineering underwater construction services; installation of oil production apparatus, and information, advisory and consultancy services in the field of installation of oil production apparatus; installation of oil exploration apparatus, and information, advisory and consultancy services in the field of installation of oil exploration apparatus; oil and water well construction completion and oil and water well environmental remediation services, and information, advisory and consultancy services in the field of oil and water well construction completion and oil and water well environmental remediation services; cleaning of buildings and industrial premises, and information, advisory and consultancy services in the field of cleaning of buildings and industrial premises; technical consulting services relating to the installation of process and industrial plants in the oil and gas industry; pipeline repair services, and information, advisory and consultancy services in the field of pipeline repair services; civil engineering maintenance services for construction projects, and

information, advisory and consultancy services in the field of civil engineering maintenance for construction projects; repair, maintenance, cleaning and installation services relating to industrial facilities such as upstream oil and gas facilities as well as processing plants and equipment, namely those used in the production and treatment of refinery sliding vane petroleum pumps, energy facilities for the production of coal, nuclear energy, renewable energy, pharmaceutical products, steam, electricity, flue gas, chemicals, metals, petrochemicals and natural gas, and oil and gas exploration and extraction equipment, tools and apparatus; construction maintenance planning, reliability, building optimisation and building construction supervision management services, information, advisory and consultancy services in the field of repair, maintenance, cleaning and installation services relating to industrial facilities such as upstream oil and gas facilities as well as processing plants and equipment, namely those used in the production and treatment of refinery sliding vane petroleum pumps, energy facilities for the production of coal, nuclear energy, renewable energy, pharmaceutical products, steam, electricity, flue gas, chemicals, metals, petrochemicals and natural gas, and oil and gas exploration and extraction equipment, tools and apparatus; construction maintenance planning, reliability, building optimisation and building construction supervision management services; decommissioning services being the deconstruction of industrial plants at end of lifecycle associated with buildings, structures, installations and projects, and information, advisory and consultancy services in the field of decommissioning services being the deconstruction of industrial plants at the end of lifecycle associated with buildings, structures, installations and projects; electrical appliance installation, maintenance and repair services, and information, advisory and consultancy services in the field of electrical appliance installation, maintenance and repair services; installation, maintenance and repair of fire and gas detection and alarm systems and fire protection apparatus, and information, advisory and consultancy services in the field of installation, maintenance and repair of fire and gas detection and alarm systems and fire protection apparatus; oil and gas well pump installation, maintenance and repair services, and information, advisory and consultancy services in the field of oil and gas well pump installation, maintenance and repair services; maintenance, repair, upgrade and overhaul of oil and gas well compressors, pumps, generators and rotating equipment, and information, advisory and consultancy services in the field of maintenance, repair, upgrade and overhaul of oil and gas well compressors, pumps, generators and rotating equipment; underwater repair services of oil and gas rigs, and information, advisory and consultancy services in the field of underwater repair services of oil and gas rigs; rental of industrial plant and industrial plant equipment for repair purposes, and information, advisory and consultancy services in the field of rental of industrial plant and industrial plant equipment for repair purposes; installation, construction, maintenance, servicing and repair of energy and power generating apparatus equipment and installations, and information, advisory and consultancy services in the field of installation, construction, maintenance, servicing and repair of energy and power generating apparatus equipment and installations; rental, hiring and leasing of equipment and apparatus for use in the oil and gas industries; dismantling and installation of construction engineering projects and plants

Class 38

(4) Telecommunications namely personal communication services (PCS) and communication by telephone communication, and VoIP telephones, and providing consultancy in the field of personal communication services (PCS) and communication by telephone communication, and VoIP telephones; telecommunications namely the operation of telephone switchboards, telephone terminals, providing access to a global computer network, and consultancy services in the field of the operation of telephone switchboards, telephone terminals, and providing access to a global computer network; site communication services namely in-vehicle communication by providing

wireless vehicle navigation and tracking, two-way radio communication, and providing consultancy services in the field of in-vehicle communication by providing wireless vehicle navigation and tracking, and two-way radio communication; radio spectrum management being the management of radio frequencies for radio broadcasting, and consultancy in the field of managing radio frequencies of radio broadcasting

Class 39

(5) Transportation services namely helicopter transport, and providing information advisory and consultancy in the field of helicopter transport; transportation of oil and gas, equipment, machinery and personnel by air, sea, road and rail, and providing information advisory and consultancy in the field of transportation of oil and gas, equipment, machinery and personnel by air, sea, road and rail; packaging of articles for transportation and warehouse storage of goods, and providing information advisory and consultancy in the field of packaging of articles for transportation and warehouse storage of goods; delivery of goods by rail, air, truck, ship, and providing information advisory and consultancy in the field of delivery of goods by rail, air, truck, ship; logistics services namely supply chain logistics and reverse logistics services consisting of the transportation of goods for others by air, rail, ship or truck, and providing information advisory and consultancy in the field of supply chain logistics and reverse logistics services consisting of the transportation of goods for others by air, rails, ship or truck; transport of oil and gas by pipeline, and providing information advisory and consultancy in the field of transport of oil and gas by pipeline; warehouse storage services namely planning and management logistics, and providing information advisory and consultancy in the field of warehouse storage services namely planning and management logistics; containerisation and freight transportation by truck, rail, boat, air, and information, advisory and consultancy in the field of containerisation and freight transportation by truck, rail boat and air

Class 40

(6) Refinery services namely the filtration and purification of gases, and consultancy in the field of refinery filtration and purification of gases; custom manufacture of steam generators, and consultancy in the field of custom manufacture of steam generators; custom manufacture of equipment for utility power and industrial facilities, namely steam generators and parts thereof, condensers, heaters, acid gas burners, rotary kilns, coal pulverizers and gasifiers and flue gas cleaning equipment, and consultancy in the field of custom manufacture of equipment for utility power and industrial facilities being steam generators and parts thereof, condensers, heaters, acid gas burners, rotary kilns, coal pulverizers and gasifiers and flue gas cleaning equipment; custom manufacture of equipment for industrial facilities, namely material handling systems for use in mines, and consultancy in the field of custom manufacture of equipment for industrial facilities, namely material handling systems for use in mines; custom manufacture of replacement parts for steam generators, condensers, heaters (including fired heaters), coal pulverizers, gasifiers, and consultancy in the field of custom manufacture of replacement parts for steam generators, condensers, heaters (including fired heaters), coal pulverizers, gasifiers; thermal processing of materials namely incineration of gases and waste incineration, and consultancy in the field of incineration of gases and waste incineration; oil and gas well treatment, and consultancy in the field of oil and gas well treatment; processing of oil and gas, and consultancy in the field of processing of oil and gas; energy production being electricity generation and oil and gas generation, and consultancy in the field of electricity generation and oil and gas generation; welding for repair purposes; operation and control of oil and gas production

Class 41

(7) Training services in the fields of oil and gas exploration and oil and gas extraction and production, and consultancy in the field of training services in the fields of oil and gas exploration and oil and gas extraction and production; provision of training programmes in the fields of oil and gas exploration and oil and gas extraction and production, and consultancy in the field of training programmes in the fields of oil and gas exploration and oil and gas extraction and production; operational training and qualification in the fields of oil and gas exploration and oil and gas extraction and production, and consultancy in the field of operational training and qualification services in the fields of oil and gas exploration and oil and gas extraction and production; training services relating to safety and to safety apparatus in the fields of oil and gas exploration and oil and gas extraction and production, and consultancy in the field of training services relating to safety and to safety apparatus in the fields of oil and gas exploration and oil and gas extraction and production; training services relating to the installation and maintenance of safety apparatus, and consultancy in the field of training services relating to the installation and maintenance of safety apparatus; training services for maintenance planning and scheduling in the fields of oil and gas exploration and oil and gas extraction and production, and consultancy in the field of training for maintenance planning and scheduling in the fields of oil and gas exploration and oil and gas extraction and production; arranging and conducting conferences, seminars and exhibitions in the fields of oil and gas exploration and oil and gas extraction and production, and consultancy in the field of arranging and conducting conferences, seminars and exhibitions in the fields of oil and gas exploration and oil and gas extraction and production; publication of technical operating manuals, and consultancy in the field of publication of technical operating manuals; publication of books and manuals, printed matter in the fields of oil and gas exploration and oil and gas extraction and production, and consultancy in the field of publication of books and manuals, printed matter in the fields of oil and gas exploration and oil and gas extraction and production; production of training videos and recordings in the fields of oil and gas exploration and oil and gas extraction and production, and consultancy in the field of production of training videos and recordings in the fields of oil and gas exploration and oil and gas extraction and production; information relating to training and education in the fields of oil and gas exploration and oil and gas extraction and production provided online from a computer database or the internet, and consultancy in the field of information relating to training and education in the fields of oil and gas exploration and oil and gas extraction and production; providing online electronic publications (not downloadable) online from databases or the internet in the fields of oil and gas exploration and oil and gas extraction and production, and consultancy in the field of providing online electronic publications from a database or the internet in the fields of oil and gas exploration and oil and gas extraction and production; publication of multi-media websites online in the fields of oil and gas exploration and oil and gas extraction and production, and consultancy in the field of publication of multi-media websites online in the fields of oil and gas exploration and oil and gas extraction and production; editing, proof reading and quality control of written educational documents in the fields of oil and gas exploration and oil and gas extraction and production, and consultancy in the field of editing, proof reading and quality control in the fields of oil and gas exploration and oil and gas extraction and production; training document specification development in the fields of oil and gas exploration and oil and gas extraction and production, and consultancy in the field of training document specification development in the fields of oil and gas exploration and oil and gas extraction and production; educational document review and collation in the fields of oil and gas exploration and oil and gas extraction and production, and consultancy in the field of educational document review and collation in the fields of oil and gas exploration and oil and gas extraction and production; document formatting, amendment and updating, electronic publishing and formatting of electronic

publications for publication, and consultancy services in relation to document formatting, amendment and updating, electronic publishing and formatting of electronic publications for publication

Class 42

(8) Mechanical engineering services, and technical consultancy in the field of mechanical engineering services; engineering services in relation to biofuel plants and installations, nuclear power plants, renewable energy projects, alternative energy projects, pharmaceutical, chemical, oil and gas facilities, plants and installations and industrial processing facilities, plants and installations, and technical consultancy in the field of engineering services in relation to biofuel plants and installations, nuclear power plants, renewable energy projects, alternative energy projects, pharmaceutical, chemical, oil and gas facilities, plants and installations and industrial processing facilities, plants and installations; engineering services relating to the extraction, processing, treatment and utilisation of oils sands, and technical consultancy in the field of engineering services relating to extraction, processing, treatment and utilisation of oils sands; scientific and technological services in relation to biofuel plants and installations, nuclear power plants, renewable energy projects, alternative energy projects, pharmaceutical, chemical, oil and gas facilities, plants and installations and industrial processing facilities, plants and installations, and technical consultancy in the field of scientific and technological services in relation to biofuel plants and installations, nuclear power plants, renewable energy projects, alternative energy projects, pharmaceutical, chemical, oil and gas facilities, plants and installations and industrial processing facilities, plants and installations; research and design services in relation to biofuel plants and installations, nuclear power plants, renewable energy projects, alternative energy projects, pharmaceutical, chemical, oil and gas facilities, plants and installations and industrial processing facilities, plants and installations, and technical consultancy in the field of research and design services in relation to biofuel plants and installations, nuclear power plants, renewable energy projects, alternative energy projects, pharmaceutical, chemical, oil and gas facilities, plants and installations and industrial processing facilities, plants and installations; industrial analysis and research services in relation to biofuel plants and installations, nuclear power plants, renewable energy projects, alternative energy projects, pharmaceutical, chemical, oil and gas facilities, plants and installations and industrial processing facilities, plants and installations, and technical consultancy in the field of scientific and technological services in relation to biofuel plants and installations, nuclear power plants, renewable energy projects, alternative energy projects, pharmaceutical, chemical, oil and gas facilities, plants and installations and industrial processing facilities, plants and installations; nuclear and energy production engineering design services, and technical consultancy in the field of nuclear and energy production engineering design services; concept and realisation design services in relation to biofuel plants and installations, nuclear power plants, renewable energy projects, alternative energy projects, pharmaceutical, chemical, oil and gas facilities, plants and installations and industrial processing facilities, plants and installations, and technical consultancy in the field of concept and realisation design in relation to biofuel plants and installations, nuclear power plants, renewable energy projects, alternative energy projects, pharmaceutical, chemical, oil and gas facilities, plants and installations and industrial processing facilities, plants and installations; civil engineering drawing services and conducting feasibility studies, and technical consultancy in the field of civil engineering drawing and conducting feasibility studies; concept development and design evaluation services in relation to biofuel plants and installations, nuclear power plants, renewable energy projects, alternative energy projects, pharmaceutical, chemical, oil and gas facilities, plants and installations and industrial processing facilities, plants and installations, and technical consultancy in the field of development and design evaluation in relation to biofuel plants and installations, nuclear power plants, renewable energy

projects, alternative energy projects, pharmaceutical, chemical, oil and gas facilities, plants and installations and industrial processing facilities, plants and installations; engineering services in the fields of structural engineering, industrial process engineering for the production of petrochemicals, industrial design in the field of instrumentation, telecommunications, electrical and electronics, mechanical engineering, piping layout, power generation and industrial plants, and technical consultancy in the field of engineering services in the fields of structural engineering, industrial process engineering for the production of petrochemicals, industrial design in the field of instrumentation, telecommunications, electrical and electronics, mechanical engineering, piping layout, power generation and industrial plants; design and development of computer hardware and software, and technical consultancy in the field of design and development of computer hardware and software; design and development of computer hardware and software for use in the oil and gas industries and for oil field exploration and searching, and technical consultancy in the field of design and development of computer hardware and software for use in the oil and gas industries and for oil field explorations and searching; oil and gas exploration and production services, and technical consultancy services in the field of oil and gas exploration and production services; provision of technical research and support for the oil and gas industries, and technical consultancy services in the field of technical research and support for the oil and gas industries; provision of civil engineering drawing workshop facilities, and technical consultancy in the provision of civil engineering drawing workshop facilities; calibration of biofuel plants and installations, nuclear power plants, renewable energy projects, alternative energy projects, pharmaceutical, chemical, oil and gas facilities, plants and installations and industrial processing facilities, plants and installations, and technical consultancy of biofuel plants and installations, nuclear power plants, renewable energy projects, alternative energy projects, pharmaceutical, chemical, oil and gas facilities, plants and installations and industrial processing facilities, plants and installations; measurement evaluations services in the field of biofuel plants and installations, nuclear power plants, renewable energy projects, alternative energy projects, pharmaceutical, chemical, oil and gas facilities, plants and installations and industrial processing facilities, plants and installations, and technical consultancy in the field of measurement evaluation of biofuel plants and installations, nuclear power plants, renewable energy projects, alternative energy projects, pharmaceutical, chemical, oil and gas facilities, plants and installations and industrial processing facilities, plants and installations; provision of quality control services of biofuel plants and installations, nuclear power plants, renewable energy projects, alternative energy projects, pharmaceutical, chemical, oil and gas facilities, plants and installations and industrial processing facilities, plants and installations, and technical consultancy of quality control of biofuel plants and installations, nuclear power plants, renewable energy projects, alternative energy projects, pharmaceutical, chemical, oil and gas facilities, plants and installations and industrial processing facilities, plants and installations; certification services namely testing, analysis and evaluation of the services of others to determine conformity with certification standards of biofuel plants and installations, nuclear power plants, renewable energy projects, alternative energy projects, pharmaceutical, chemical, oil and gas facilities, plants and installations and industrial processing facilities, plants and installations, and technical consultancy testing, analysis and evaluation of the services of others to determine conformity with certification standards of biofuel plants and installations, nuclear power plants, renewable energy projects, alternative energy projects, pharmaceutical, chemical, oil and gas facilities, plants and installations and industrial processing facilities, plants and installations; computer system integration testing, and technical consultancy in the field of computer system integration testing; authentication testing of data in the field of biofuel plants and installations, nuclear power plants, renewable energy projects, alternative energy projects, pharmaceutical, chemical, oil and gas facilities, plants and installations and industrial processing facilities, plants and installations, and technical consultancy in the field of

authentication testing of data in the field of biofuel plants and installations, nuclear power plants, renewable energy projects, alternative energy projects, pharmaceutical, chemical, oil and gas facilities, plants and installations and industrial processing facilities, plants and installations; testing of apparatus and equipment of biofuel plants and installations, nuclear power plants, renewable energy projects, alternative energy projects, pharmaceutical, chemical, oil and gas facilities, plants and installations and industrial processing facilities, plants and installations, and technical consultancy in the field of testing of apparatus and equipment of biofuel plants and installations, nuclear power plants, renewable energy projects, alternative energy projects, pharmaceutical, chemical, oil and gas facilities, plants and installations and industrial processing facilities, plants and installations; consumer product safety testing of products and apparatus, and technical consulting in the field of consumer product safety testing of products and apparatus; provision of testing and inspection facilities for oil and gas equipment and apparatus, and technical consultancy in the field of testing and inspection facilities for oil and gas equipment and apparatus; material testing services, and technical consulting services in the field of material testing services; laboratory testing of materials , and technical consulting in the field of laboratory testing of materials; industrial material and chemical testing of engineering projects, and industrial material and chemical testing of engineering projects; welding research services; engineering surveying, land surveying, oil field surveying, and technical consultancy in the field of engineering surveying, land surveying, and oil field surveying; provision of analysis, testing and research facilities for engineering projects of new products for others, and technical consulting in the field of analysis, testing and research facilities for engineering projects of new products for others; research in the field of environmental protection services, and technical consulting in the field of research in the field of environmental protection services; environmental planning services in the field of audits and risk assessments for engineering projects in the oil and gas industry, nuclear energy industry and the mining industry, and technical consultancy in the field of environmental planning audits and risk assessments for engineering projects in the oil and gas industry, nuclear energy industry and the mining industry; environmental design services in the field of mining and oil and gas, and technical consulting in the field of environmental design in the field of mining and oil and gas; concept design services for others, and technical consultancy in the field of concept design services for others; geological research and exploration services, and technical consultancy in the field of geological research and exploration services; operation and control of oil and gas exploration; computer aided design CAD services in the field of construction, and technical consultancy in the field of computer aided design for construction; technical documentation and reports for engineering projects, and technical consultancy in the field of technical documentation and reports for engineering projects; graphic design services and computer graphic services for technical and engineering drawing, and technical consultancy in the field of graphic design services and computer graphic services for technical and engineering drawing; civil engineering design, research and development services for others, and technical consultancy in the field of engineering design, research and development services for others; technical chemical research for others, and technical consultancy in the field of chemical research for others; civil engineering design services, and technical consultancy in the field of civil engineering design services; technical validation services in the field of energy auditing, and technical consultancy in the field of technical validation for energy auditing; engineering design services relating to construction planning, architecture, civil engineering, mechanical engineering, civil design engineering, fire prevention engineering, petrochemical engineering and industrial plants, and technical consultancy in the field of engineering design services relating to construction planning, architecture, civil engineering, mechanical engineering, civil design engineering, fire prevention engineering, petrochemical engineering and industrial plants; mechanical engineering systems design services, and technical consulting in the field of mechanical engineering system design; provision of safety

advice in relation to construction engineering and production projects and industrial plants and processes; provision of hazard and operability studies relating to hazardous materials management, and technical consulting in the field of hazardous material management and operability studies; software engineering services; design of computer network systems, and technical consultancy in the field of computer network systems design; design and planning services associated with oil and gas well equipment and plant layout; engineering and technological assistance for procurement of environmental permits; geotechnical engineering services; oil and gas piping systems design and layout services, and technical consultancy in the field of oil and gas piping systems design and layout services; design of ventilation, heating and air conditioning systems and apparatus; civil engineering design and coordination and consultancy services; computer engineering modelling and computer process modelling services in relation to biofuel plants and installations, nuclear power plants, renewable energy projects, alternative energy projects, pharmaceutical, chemical, oil and gas facilities, plants and installations and industrial processing facilities, plants and installations, and technical consulting in the field of computer engineering modelling and process modelling for use in mining and the oil and gas industry; computer modelling services; finite element modelling; finite element analysis services; thermodynamic modelling; process simulation and optimisation of industrial plants and projects; computer process troubleshooting services; hazard identification services provided by means of computer modelling; computational fluid dynamics engineering services; computer engineering and computer technological services for the automation of computer systems and industrial plants operations; energy auditing services; seismic analysis services; product design services for others; industrial plant and construction site safety and safety management services; environmental due diligence services; industrial plant, oil fields, oil burners, and pipeline equipment inspection and testing; consultancy services relating to environmental issues; technical writing of technical and engineering operating manuals; remote oil well control system design services, and technical consultancy in the field of remote oil well control system design services; computer and oil and gas system engineering services; project certification services, and technical consultancy in the field of project certification services; technical handover services of industrial plants in the oil and gas industry, and technical consultancy in the field of technical handover industrial plants in the oil and gas industry; construction engineering permit to work coordination; construction engineering audit reviews for integrity process status; technical writing and illustration; civil infrastructure engineering and construction; engineering and technical consultancy services in the fields of oil and gas production, pipeline and processing facilities; design of information systems relating to business management; 3D laser scanning services of oil and gas facilities, and technical consultancy in the field of 3D laser scanning of oil and gas facilities; industrial plant and installation engineering surveying services, and technical consultancy in the field of industrial plant and installation engineering surveying services; civil engineering plant design management systems; development of interactive multi-media software, and technical consulting in the field of development of interactive multi-media software; software design services for the design and data management of subsea systems, pipelines and risers; valve design services; development of computerised construction engineering management systems, and technical consultancy in the field of development of computerised construction engineering management systems; technical software authoring in the field of engineering design services relating to construction planning, architecture, civil engineering, mechanical engineering, civil design engineering, fire prevention engineering, petrochemical engineering and industrial plants, and technical consultancy in the field of technical software authoring in the field of engineering design services relating to construction planning, architecture, civil engineering, mechanical engineering, civil design engineering, fire prevention engineering, petrochemical engineering and industrial plants; editing of computer programmes; engineering lifecycle integrity services of oil and gas wells, pipelines, plants, rigs and mines, and

technical consultancy in the field of engineering lifecycle integrity of oil and gas wells, pipelines, plants, and rigs; Technical and engineering advice relating to fire safety engineering services; engineering project management relating to the design and chemical engineering operations for industrial and oil and gas process plants, and technical consultancy in the field of engineering project management relating to the design and chemical engineering operations for industrial and oil and gas process plants; design and development of lifecycle management software, and technical consultancy in the field of design and development of lifecycle management software; inspection and calibration of safety systems, fire and gas detection systems, navigation aids, fire extinguishers, remote monitoring systems, page party alarm systems and pneumatic/electrical safety systems, all being for use in the oil, gas and renewable energy industries, and technical consultancy in the field of inspection and calibration of safety systems, fire and gas detection systems, navigation aids, fire extinguishers, remote monitoring systems, page party alarm systems and pneumatic/electrical safety systems, all being for use in the oil, gas and renewable energy industries; technical project studies and construction design engineering relating to construction planning, architecture, mechanical engineering, fire prevention engineering, petrochemical engineering and industrial plants; design engineering in relation to material handling systems for use in mines, and technical consulting in the field of design engineering material handling systems for use in mines; electrical engineering services; mechanical engineering; geotechnical engineering; thermal engineering; technical consulting in the fields of electrical engineering, mechanical engineering and thermal engineering; instrument control engineering for use in the mining and oil and gas industries, and technical consulting in the field of mining and oil and gas; energy and flare gas surveys, and technical consulting in the field of energy and flare gas surveys; mechanical engineering systems design, and technical consultancy in the field of mechanical engineering systems design; electrical systems design for energy distribution; packaging container systems design, and technical consultancy in the field of packing design; oil and gas piping systems design and water piping systems design, and technical consultancy in the field of oil and gas piping systems design and water piping systems design; materials handling systems design for the mining industry, and technical consultancy in the field of materials handling systems design for the mining industry; heating, ventilating and air conditioning systems design, and technical consultancy in the field of heating, ventilating and air conditioning systems design; software engineering, and technical consulting in the field of software engineering; data analysis services for mining and oil field exploration, and technical consultancy in the field of data analysis for mining and oil field exploration; conversion of data from physical to electronic media and from one media to another, technical consultancy in the field of the conversion of data from physical to electronic media and from one media to another; data mining in the field of mining and oil and gas, as well as in the energy sector, and technical consultancy in the field of data mining for use in mining and oil and gas, as well as for the energy sector; computer design and development services, and technical consultancy in the field of computer design and development; providing non-downloadable software for data mining in the field of mining and oil and gas, as well as in the energy sector, and technical consultancy in the field of non-downloadable software for data mining used in the mining, oil and gas, as well as for the energy sectors; technological studies and technical studies relating to projects, products and industrial processes, namely industrial process development; technological and technical studies, namely studies relating to electricity grid codes and the connection of facilities to electricity networks; technological services for the computer automation of systems in the mining, oil and gas, and energy generation industries; preparing, designing and conducting energy studies, and technical consulting in the field of preparing, designing and conducting energy studies; preparing, designing and conducting audits specifically audits in the field of mining reserves and in the field of energy, and technical consulting in the field of preparing, designing and conducting audits in the field of mining reserves and in the field of

energy; preparing, designing and conducting energy surveys; conducting of technical feasibility studies; technical consultation in the field of delayed coking; technical consultation in the field of energy and emissions management, as well as solvent deasphalting, visbreaking, hydrogen production and sulphur/tail gas treatment; seismic analysis services, and technical consultancy in the field of seismic analysis; architectural services, and technical consultancy in the field of architectural and structural design in the field of civil engineering; structural design services in the field of civil engineering; building condition surveys, and technical consultancy in the field of building condition surveys; surveying services namely the surveying of land, quantity surveying of the lifecycle of an oil and gas and mining facility, conducting engineering surveys, conducting geological surveys and oil and gas field surveys, and technical consulting in the field of surveying of land, quantity surveying of the lifecycle of an oil and gas and mining facility, conducting engineering surveys, conducting geological surveys and oil and gas field surveys; yield improvement services for use in the mining and oil and gas industries, technical consultancy in the field of yield improvement for the mining and oil and gas industries; computer system integration services, and technical consultancy in the field of computer system integration services; industrial plant energy audits and surveys; fire safety equipment inspection and assessment, as well as safety assessment of an industrial plant and related machinery, and technical consultancy in the field of fire safety equipment inspection and assessment, as well as safety assessment of an industrial plant and related machinery; consumer product quality assessment services, and technical consultancy in the field of consumer product quality assessment services; materials testing services, namely consumer product testing for others; industrial process evaluation, simulation and modelling in the field of mining and oil and gas; industrial process troubleshooting and optimisation in the field of mining and oil and gas; safety advice in relation to engineering and production projects and processes, hazard and operability studies; oil and gas exploration services, and technical consultancy in the field of oil and gas exploration; building, construction and engineering project management; conducting engineering feasibility studies relating to building and construction; civil engineering drawing services; civil engineering design consultancy in relation to plumbing and gas and water installations; computer network traffic management

Class 44

(9) Landscape maintenance and design

Class 45

(10) Consultancy services relating to occupational health and safety, and providing information in the field of occupational health and safety; risk management consultancy relating to occupational health and safety; occupational health and safety program development, management and consultation; occupational hazard and operability studies, and occupational hazard identification procedures, and providing information, advisory and consultancy in the field of occupational hazard operability studies and occupational hazard identification; facility and onsite audits and third party inspections in the field of occupational health and safety, and providing information, advisory and consultancy services in the field of facility and onsite audits in the field of occupational health and safety; site safety and safety management to meet the needs of commercial and industrial companies, and providing information, advisory and consultancy services in the field of site safety and safety management of commercial and industrial companies; advisory services in the field of regulatory affairs and compliance on safety at work; regulatory compliance audits on occupational health and safety, and providing information, advisory and consultancy services in the field of regulatory compliance audits for occupational health and safety; reviewing standards and practices to assure compliance with laws and regulations on safety at work, and providing information, advisory and consultancy services in the field of reviewing standards and practices to assure compliance with laws and regulations on safety at work; rental of safety equipment being

protective clothing, and providing information, advisory and consultancy services in the field of protective clothing rental; fire and burglar alarm monitoring services; monitoring of security systems; and information, advisory and consultancy services in the field of fire and burglar alarm monitoring, and monitoring of security systems; fire protection and detection services

Claims

Priority Filing Date: October 08, 2017, Country or Office: SWAZILAND, Application No: UK00003262016 in association with the same kind of services (4); October 08, 2017, Country or Office: UNITED KINGDOM, Application No: UK00003262016 in association with the same kind of goods and in association with the same kind of services (1), (2), (3), (5), (6), (7), (8), (10)

Application Number 1,893,197
Language of Application English

Filing Date 2018-04-11

APPLICANT AND AGENT DETAILS

Applicant

Homecare Products, Inc.
700 Milwaukee Avenue North
Algona, Washington , WA 98001
UNITED STATES OF AMERICA

Agent

JENSEN IP
103 - 2150 Thurston Drive, Ottawa, ONTARIO,
K1G5T9

TRADEMARK DETAILS

EZ-ACCESS

Trademark Type

Word

Goods

Class 06

(1) Metal portable stairs; Metal stairs; Metal modular entry ramps for doorways, sliding glass doors, and raised landings; Occupational Safety and Health Administration (OSHA) compliant products for use in temporary construction sites in the mobile modular industry, namely, metal portable stairs; Portable metal ramps namely curb ramps, threshold ramps, vehicle entry ramps, vehicle loading ramps, loading dock ramps, entry ramps for residential, commercial and industrial buildings and walkway ramps; Multipurpose metal ramps for commercial and industrial use, namely curb ramps, threshold ramps, vehicle entry ramps, vehicle loading ramps, loading dock ramps, building entry ramps and walkway ramps; Metal platforms used to build modular walkways and multi-level modular walkways; metal work platforms and building platforms used for construction and industrial work sites;

Class 07

(2) Electric door openers; raiseable work platforms, raiseable building platforms and mechanical lift platforms for loading and unloading cargo, and for wheelchair entry into vehicles and residential, commercial and industrial buildings;

Class 09

(3) Battery packs for powering wheelchairs, door openers, toilet seat openers, patient lifts and for powering platform lifts for wheelchair entry into vehicles and residential, commercial and industrial buildings;

Class 10

(4) Toilet accessories, namely, toilet lifts; toilet lifts, namely, attachable lifts for lifting and lowering toilet seats; toilet seat risers; Toilet accessories, namely, toilet lifts incorporating a safety frame and seat riser, all the aforesaid goods adapted for medical patients or for use by disabled persons; toilet lifts, namely, toilet seats adapted for use by medical patients and disabled persons; adjustable toilet seats adapted for use by medical patients and disabled persons; Patient transfer lifts, namely, mobility devices used to assist in the movement of patients from one place or one

position to another; Pivot transfer lifts, namely wall-to-floor or floor-to-ceiling mounted articulating arms for attaching a sling and motor lift assembly for use in transferring patients from one place or position to another;

Class 11

(5) Portable showers, Inflatable bathtubs; inflatable sinks;

Claims

Priority Filing Date: October 11, 2017, Country or Office: UNITED STATES OF AMERICA,
Application No: 87/642224 in association with the same kind of goods

Application Number 1,895,665
Language of Application English

Filing Date 2018-04-25

APPLICANT AND AGENT DETAILS

Applicant

Apple Inc.
One Apple Park Way
Cupertino, CA 95014
UNITED STATES OF AMERICA

Agent

BAKER & MCKENZIE LLP
BROOKFIELD PLACE, 181 BAY STREET,
SUITE 2100, P.O. BOX 874, TORONTO,
ONTARIO, M5J2T3

TRADEMARK DETAILS

Trademark Type

Three-dimensional (3-D)

Visual Representation

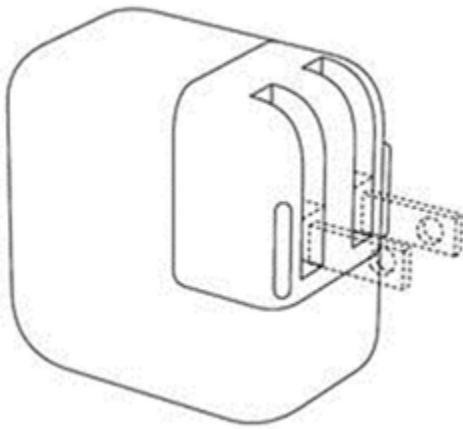

Trademark Description

Color is not claimed as a feature of the mark. The mark consists of a three-dimensional configuration of an adapter in the shape of a cube having four sides with rounded corners, a flat front and flat back surface. The broken lines depicting a electrical prongs indicate placement of the mark on the goods and are not part of the mark.

Registrability Recognized

Registrability recognized under the Trademarks Act.

Goods

Class 09

Adapters for use with computers, computer peripherals and consumer electronics namely portable and handheld digital electronic devices namely, handheld computers, tablet computers, mobile phones, electronic book readers and notepads, electronic personal organizer, personal digital assistant, electronic calendar, global positioning system (GPS) devices, cameras, electronic handheld game units, and digital format media players namely, MP3 players

Application Number 1,897,002
Language of Application English

Filing Date 2018-05-02

APPLICANT AND AGENT DETAILS

Applicant

Ojo Labs, Inc.
Floor 14
600 Congress Avenue
Austin, TX 78701
UNITED STATES OF AMERICA

Agent

CASSELS BROCK & BLACKWELL LLP
SCOTIA PLAZA, SUITE 2100, 40 KING
STREET WEST, TORONTO, ONTARIO,
M5H3C2

TRADEMARK DETAILS

OJO

Trademark Type

Standard Characters

Goods

Class 09

Downloadable mobile applications for providing consumers with real-time recommendations, demographics, and location data regarding local businesses and leisure activities using natural language processing and artificial intelligence; computer software for providing for interaction of a user with a conversational user interface for the distribution of consumer information in the field of real estate; computer software for retrieving information from a user and delivering to the user context-sensitive information and user-specific information in the field of consumer information in connection with real estate; computer software for transmitting information to a user from an adaptive, artificially intelligent software agent in the field of consumer information in connection with real estate; computer software in the field of artificial intelligence, namely, software for converting natural language voice and text into machine executable commands; computer software, namely, an interpretive interface for facilitating interaction between humans and computers and mobile phones via voice and text message-enabled conversational agents and chat bots; computer software used to process natural language voice and text commands, and create natural language voice and text responses to voice and text commands; computer software for providing purchase information in response to voice and text data; computer software for providing information on home-buying process and purchase information in response to voice and text data; computer software, namely, an interactive interface for receiving consumer preference information and providing information about real estate available for sale; computer software, namely, an interactive interface for receiving consumer preference information and providing information about real estate available for sale; computer application software for mobile phones, portable media players, and handheld computers, namely, artificial intelligence and natural language processing software for providing instructional data and information for searching, locating, rating, evaluating and providing directions for the purchase of real estate and consumer products and services; computer application software for mobile phones, portable media players, and handheld computers, namely, artificial intelligence and natural language processing software for providing instructional data and information for searching, locating, rating, evaluating and providing directions for the home-buying process; computer software for providing information relating to the home-buying process; computer software for use in finding services providers in the

fields of real estate, mortgages, moving services, home services, title services and insurance; computer software that functions as a virtual personal assistant for users of computers and mobile phones; computer application software for mobile phones, namely, software for use in finding services providers in the fields of real estate and mortgages; computer software for use in finding services providers for use in the fields of real estate and mortgages; computer software for providing information to consumers in the fields of mortgages, moving services, home services, title services.

Services

Class 35

(1) Providing consumer product and related service information in the field of real estate via the Internet and text messaging.

Class 36

(2) Providing information to consumers in the fields of real estate, mortgage financing, real estate title insurance underwriting services and insurance; providing real estate listings via the Internet and text messaging.

Class 37

(3) Providing information to consumers in the field of home repair services.

Class 39

(4) Providing information to consumers in the field of moving services.

Class 42

(5) Providing on-line, non-downloadable software for identifying preferences of consumers and matching preferences to consumer products and services in the marketplace; providing on-line, non-downloadable software for identifying preferences of consumers and matching preferences to available real estate in the marketplace; providing on-line, non-downloadable survey software which can produce real estate matching reports and individualized real estate preference reports and identify best match candidates for real estate purchase; providing temporary use of on-line non-downloadable computer software for retrieving information from a user and delivering to the user context-sensitive information and user-specific information in the fields of real estate, mortgage financing, and mortgage insurance; providing temporary use of on-line nondownloadable computer software for transmitting information in the fields of real estate, mortgage financing, and mortgage insurance to a user from an adaptive, artificially intelligent software agent; providing temporary use of on-line non-downloadable computer software for providing consumer products and services features and purchase information in response to voice and text data; providing temporary use of on-line non-downloadable computer software for providing real estate market and purchase information in response to voice and text data; providing temporary use of on-line non-downloadable computer software featuring an interactive interface for receiving consumer preference information and providing information about real estate, mortgages, moving services, home services, title services and insurance.

Class 45

(6) Providing information to consumers in the field of title searching services.

Application Number 1,897,003
Language of Application English

Filing Date 2018-05-02

APPLICANT AND AGENT DETAILS

Applicant

Ojo Labs, Inc.
Floor 14
600 Congress Avenue
Austin, TX 78701
UNITED STATES OF AMERICA

Agent

CASSELS BROCK & BLACKWELL LLP
SCOTIA PLAZA, SUITE 2100, 40 KING
STREET WEST, TORONTO, ONTARIO,
M5H3C2

TRADEMARK DETAILS

Trademark Type

Design

Visual Representation



Goods

Class 09

Downloadable mobile applications for providing consumers with real-time recommendations, demographics, and location data regarding local businesses and leisure activities using natural language processing and artificial intelligence; computer software for providing for interaction of a user with a conversational user interface for the distribution of consumer information in the field of real estate; computer software for retrieving information from a user and delivering to the user context-sensitive information and user-specific information in the field of consumer information in connection with real estate; computer software for transmitting information to a user from an adaptive, artificially intelligent software agent in the field of consumer information in connection with real estate; computer software in the field of artificial intelligence, namely, software for converting natural language voice and text into machine executable commands; computer software, namely, an interpretive interface for facilitating interaction between humans and computers and mobile phones via voice and text message-enabled conversational agents and chat bots; computer software used to process natural language voice and text commands, and create natural language voice and text responses to voice and text commands; computer software for providing purchase information in response to voice and text data; computer software for providing information on home-buying process and purchase information in response to voice and text data; computer software, namely, an interactive interface for receiving consumer preference information and providing information about real estate available for sale; computer software,

namely, an interactive interface for receiving consumer preference information and providing information about real estate available for sale; computer application software for mobile phones, portable media players, and handheld computers, namely, artificial intelligence and natural language processing software for providing instructional data and information for searching, locating, rating, evaluating and providing directions for the purchase of real estate and consumer products and services; computer application software for mobile phones, portable media players, and handheld computers, namely, artificial intelligence and natural language processing software for providing instructional data and information for searching, locating, rating, evaluating and providing directions for the home-buying process; computer software for providing information relating to the home-buying process; computer software for use in finding services providers in the fields of real estate, mortgages, moving services, home services, title services and insurance; computer software that functions as a virtual personal assistant for users of computers and mobile phones; computer application software for mobile phones, namely, software for use in finding services providers in the fields of real estate and mortgages; computer software for use in finding services providers for use in the fields of real estate and mortgages; computer software for providing information to consumers in the fields of mortgages, moving services, home services, title services.

Services

Class 35

(1) Providing consumer product and related service information in the field of real estate via the Internet and text messaging.

Class 36

(2) Providing information to consumers in the fields of real estate, mortgage financing, real estate title insurance underwriting services and insurance; providing real estate listings via the Internet and text messaging.

Class 37

(3) Providing information to consumers in the field of home repair services.

Class 39

(4) Providing information to consumers in the field of moving services.

Class 42

(5) Providing on-line, non-downloadable software for identifying preferences of consumers and matching preferences to consumer products and services in the marketplace; providing on-line, non-downloadable software for identifying preferences of consumers and matching preferences to available real estate in the marketplace; providing on-line, non-downloadable survey software which can produce real estate matching reports and individualized real estate preference reports and identify best match candidates for real estate purchase; providing temporary use of on-line non-downloadable computer software for retrieving information from a user and delivering to the user context-sensitive information and user-specific information in the fields of real estate, mortgage financing, and mortgage insurance; providing temporary use of on-line nondownloadable computer software for transmitting information in the fields of real estate, mortgage financing, and mortgage insurance to a user from an adaptive, artificially intelligent software agent; providing temporary use of on-line non-downloadable computer software for providing consumer products and services features and purchase information in response to voice and text data; providing temporary use of on-line non-downloadable computer software for providing real estate market and purchase information in response to voice and text data; providing temporary use of on-line non-downloadable computer software featuring an interactive interface for receiving consumer

preference information and providing information about real estate, mortgages, moving services, home services, title services and insurance.

Class 45

(6) Providing information to consumers in the field of title searching services.

Application Number 1,897,077
Language of Application English

Filing Date 2018-05-02

APPLICANT AND AGENT DETAILS

Applicant

4 Pillar Dynasty LLC (A Limited Liability
Company of the state of New York)
525 7th Avenue, Suite 1601
New York, NY 10018
UNITED STATES OF AMERICA

Agent

ANDREWS ROBICHAUD
1673 Carling Avenue, Suite 215, Ottawa,
ONTARIO, K2A1C4

TRADEMARK DETAILS

HYPERTEK

Trademark Type

Word

Goods

Class 09

(1) Goggles for sports; Protective sports helmets

Class 18

(2) All-purpose carrying bags; Athletic bags; Backpacks; General purpose bags for carrying yoga equipment, namely, gym bags for carrying yoga equipment; Gym bags

Class 21

(3) Sports bottles, sold empty

Class 24

(4) Towels of textile

Class 25

(5) Athletic pants; Athletic shirts; Athletic shorts; Athletic apparel, namely, tops and bottoms for yoga; Bathing suits; Beachwear; Bikinis; Tracksuit Bottoms; Bras; Capris; Caps; Footwear, namely, shoes, athletic shoes, slippers, boots and sandals; Gloves; Hats; Headbands; Hooded sweatshirts; Jackets; Leggings; Loungewear; Pants; Shirts; Shorts; Socks; Sports bras; Sports caps and hats; Sweatpants; Sweatshirts; T-shirts; Tank tops; Tights; Underwear; Yoga pants; Yoga shirts

Class 27

(6) Yoga mats

Class 28

(7) Exercise weights; Jump ropes; Manually-operated exercise equipment for physical fitness purposes, namely, yoga; Stretch bands used for yoga and physical fitness purposes; Yoga blocks

Application Number 1,900,332
Language of Application English

Filing Date 2018-05-22

APPLICANT AND AGENT DETAILS

Applicant

8372683 CANADA INC.
7250 Route Transcanada
Saint-Laurent
QUEBEC
H4T1A3

Agent

RONALD R. TOLEDANO
(SPIEGEL SOHMER INC.), 1255 Peel Street,
Suite 1000, Montreal, QUEBEC, H3B2T9

TRADEMARK DETAILS

UV ALERT

Trademark Type

Word

Goods

Class 25

Clothing, namely, pants, jumpers, shirts, polo shirts, sweaters, vests, sweat shirts, sportswear and athletic wear; outerwear, namely, snow pants, snow suits, coats, raincoats, rainwear, overcoats, winter coats, trench coats and jackets; infant and toddler one piece clothing; footwear, namely, infant and children's footwear, outdoor footwear, winter footwear, rain footwear, casual footwear, sports footwear, athletic footwear, shoes, boots, ski boots, construction boots and sneakers; socks; gloves; headwear, namely, headbands, hats, caps, baseball caps and sunhats

Application Number 1,902,738
Language of Application French

Filing Date 2018-06-05

APPLICANT AND AGENT DETAILS

Applicant

FRAMATOME, Société par actions simplifiée
1 Place Jean Millier, Tour Areva
92400, Courbevoie
FRANCE

Agent

LAVERY, DE BILLY, LLP
1 Place Ville Marie, Suite 4000, Montréal,
QUÉBEC, H3B4M4

TRADEMARK DETAILS

Framatome

Trademark Type

Word

Goods

Class 01

(1) Chemicals used in the composition of, and constituting, neutron resins, namely industrial chemicals for the power industries for the manufacture of synthetic rubber and polymer products, ion-exchange resin membranes in the form of chemicals, chemicals for use in the nuclear fuel cycle, in the form of nuclear materials, namely uranium ore, uranium, plutonium in all chemical forms and isotope compounds; nuclear fuels.

Class 04

(2) Fuels, namely oils, greases and lubricants for use in the nuclear power industries.

Class 05

(3) Pharmaceutical preparations for nuclear medicine, namely isotopes for medical use, radioactive indicators for therapeutic use and for medical imaging; diagnostic products for medical use, in particular for locating cancerous tumours in the human body, namely radioactive indicators for diagnostic use, reactive preparations for medical diagnostic use, radioactive pharmaceutical preparations for in-vivo diagnostics.

Class 06

(4) Unwrought and semi-wrought common metals and their alloys, for use in the nuclear power industries, plants and centres for the storage, warehousing, isotope separation, processing, reprocessing and recycling of fuels, ores, nuclear materials, uranium, plutonium and nuclear waste; metal materials for building and construction and transportable buildings of metal for nuclear power plants, nuclear reactors and water reactors; metal cables and wires, metal hardware, namely hardware nails, rods of metal for brazing and welding, screws of metal, metal nuts and metal pipes and tubes for nuclear power plants, for nuclear reactors.

Class 07

(5) Machine tools for metalworking; motors and engines, except motors and engines for land vehicles, namely motors and engines and power units for the generation of electricity, diesel engines for industrial machinery, electric motors for machines; non-electric couplings other than for land vehicles, namely couplings for machines, hydraulic couplings as machine parts; transmission

assemblies and belts, other than those for land vehicles, namely shaft couplings and transmission components, transmissions for industrial machinery; machines, namely pumps, namely centrifugal pumps, self-regulating fuel pumps, pumps as parts of machines, motors and engines, hydraulic pumps, machines, namely pumping motor units; machines, namely mechanical equipment, namely power operated jacks, turbine generators, turbines for thermal power plants, used for and in the nuclear field, machines, namely industrial robots, pressurizers, namely tanks for regulating the pressure in the primary coolant system used in the nuclear field, turbochargers, control rod drive mechanisms, as well as all their replacement parts; electrically and electronically operated hand tools, namely electric generators, drills, steel and diamond wire saws, circular saws, laser cutting tools and routers; machine tools, machines and apparatus used in the nuclear power industry for the manufacture, handling, processing, warehousing, isotope separation and storage of ores, metals, nuclear fuels, nuclear materials, plutonium, uranium and nuclear waste, namely machines for loading and unloading nuclear fuel, motorized devices for controlling valves and fittings used in nuclear reactors, motorized, robotic and remotely operated tools for the checking (supervision), repair and replacement of components in nuclear reactors, nuclear facilities and nuclear fuels, namely robot arms, telescopic arms, remotely operated arms, their components and replacement parts, namely manipulator arms, telescopic arms and remotely operated arms for industrial robots, as well as their components and replacement parts; robots for work, checking, measuring, collection, sampling and supervision efforts in contaminated areas, namely industrial robots, camera drones and autonomous underwater industrial robots; power generators; engine starters; engine control centres; rotating and stationary electric machines, namely pneumatic and hydraulic jacks and speed governors for machines, engines and motors, electronic speed controllers for electric motors, electric motors for machines, their variable speed drive combinations, namely speed governors, machines, and motors and engines; machine tools for the design, manufacture and testing of electric and electronic components.

Class 09

(6) Scientific, surveying, electric, electronic, optical, weighing, measuring, signalling, checking, supervision, life-saving and rescue apparatus and instruments, all used in the nuclear power industries, namely monitoring instruments and physicochemical analysis instruments intended for nuclear power plants, for nuclear reactors, laser measuring tapes, instruments for monitoring and analyzing radioactivity, namely nuclear radiation detectors; apparatus, instruments and devices for the checking and monitoring of industrial facilities in the field of nuclear power, namely cameras, video surveillance installations; radioactivity detection apparatus, namely Geiger counters; computer programs, namely software packages, software and alarms for the checking and monitoring of industrial facilities; computer programs, namely information technology programs in the form of computer operating programs, namely software for controlling and managing access server applications, database management software used in the nuclear power industries, search engine and information indexing software, monitoring, management software related to nuclear activities, criticality and process supervision software, software packages, namely information technology programs in the form of computer operating programs for operational and safety control (core criticality) for the generation of electricity derived from nuclear facilities; electric and electronic components, namely semiconductors, semiconductor devices, namely semiconductor chips, semiconductor integrated circuits, electronic cards, electronic microcircuits and circuits, integrated circuits, namely chips, microprocessors, microcontrollers, integrated circuits composed of a network of programmable cells and units containing the above components; topographic apparatus and instruments, namely 3D scanners; masks for protection against radiation; flash memory cards, random access memory cards; electric couplings; rotating and stationary electric machines, namely voltage regulators; electronic speed controllers for electric motors; electronic

speed controllers for electric motors, electric motors for machines, their variable speed drive combinations, namely speed governors, machines, and motors and engines; machine tools for the design, manufacture and testing of electric and electronic components.

Class 11

(7) Heating, steam generating, heat exchange apparatus, namely steam generating installations, steam generators and accumulators, heat exchangers, heat exchangers for chemical processing, heat accumulators, steam and temperature regulators for industrial heating installations intended for power generation, refrigerated cabinets, refrigerating chambers, refrigeration condensers, refrigerated transport containers, chemical fibre drying machines, rotary dryers for industrial use, air impellers for ventilation, wind turbine ventilators intended for nuclear power plants, for nuclear reactors, for plants and centres for the storage, warehousing, isotope separation, processing, reprocessing and recycling of fuels, ores, nuclear materials, uranium, plutonium and nuclear waste; steam generators; industrial steam boilers for power generation for machinery, industrial boilers, heating boilers; nuclear islands, nuclear facilities and assemblies for processing nuclear moderating materials and fuels, namely nuclear reactors, nuclear generators; gas generators, in particular those using electrolysis, reforming, gasification, water decomposition.

Class 19

(8) Materials, not of metal, for building and construction and transportable buildings, not of metal, namely reinforcement materials, namely insulating glass for construction, glass for construction, cement mixes, cement aggregates, filling cement, roofing cement, concrete and bitumen for nuclear power plants, for nuclear reactors, for uranium mines, plants and centres for the storage, warehousing, isotope separation, processing, reprocessing and recycling of fuels, ores, nuclear materials, uranium, plutonium and nuclear waste; materials, not of metal, for building and construction and transportable buildings, not of metal, namely non-metal rigid pipes and ducts for non-nuclear boilers, namely rigid PVC pipes and ducts for construction, plastic drain pipes, fibreglass drainage pipes; non-metal rigid pipes and ducts, namely non-metal downspouts, non-metal drain pipes, for nuclear power plants, for nuclear reactors, for uranium mines, plants and centres for the storage, warehousing, isotope separation, processing, reprocessing and recycling of fuels, ores, nuclear materials, uranium, plutonium and nuclear waste; non-metal rigid pipes and ducts for non-nuclear boilers, namely non-metal downspouts, non-metal drain pipes.

Services

Class 35

(1) Advertising and business in the field of nuclear power, namely advertising related to the goods and services of others conducted through all public communication means, strategic business analysis in the field of nuclear power; business management assistance in the field of nuclear power; business management assistance for subsidiaries; administrative management of subsidiaries; administrative management of shares and stocks held in third-party companies; business organization and management advice for subsidiaries; advice and consulting about, strategy planning, organization and management related to businesses and personnel; market research and studies related to equity participation in third-party businesses; accounting, income tax return preparation, drafting of statements of accounts, account auditing; economic forecasting; promotional and commercial sponsorship and patronage, namely development of advertising campaigns for others, mediation of advertising for others; analysis, design, development and management of computer systems and information technology systems, namely provision of business information directories on the Internet, general information clearing house, collection of market research information. .

Class 37

(2) Construction, installation, operation and maintenance of infrastructure, plants, facilities, equipment and apparatus in the fields of energy, namely renewable energies, climate change and global warming, and electronics, namely combination carbon monoxide and smoke detectors, radon detectors, gamma radiation detectors, thermal sensors; construction, installation and maintenance of plants and centres for the storage, processing, reprocessing and recycling of fuels, ores, nuclear materials, uranium and plutonium; construction, installation and maintenance of nuclear power plants, nuclear reactors, non-nuclear boilers, research and engineering facilities and equipment in the fields of energy, renewable energies, and climate change and global warming; construction, installation and maintenance of facilities, equipment used in the transport of materials in the field of nuclear power; construction supervision, information related to construction in the fields of nuclear power, renewable energies, and climate change and global warming; cleaning, decontamination, sanitation, maintenance and renovation, of nuclear facilities, and of equipment and apparatus in the nuclear field.

Class 38

(3) Electronic messaging and mail services; communication via computer terminals and transmission of information in the fields of nuclear power and electronics through websites and secure electronic mail services; remote communication, namely provision of access to a computer network for the remote control and operation of equipment from generator facilities and nuclear reactors, namely for the checking, regulating, measuring, signalling, regulation, control, operation, protection, and monitoring of the said facilities; dissemination and transmission of messages, information and data via extranet, Internet and intranet networks in the fields of nuclear power and electronics; wired and wireless data and information transmission network services, namely provision of multiple-user access to global computer information networks for the transfer and dissemination of a wide range of information.

Class 40

(4) Energy generation and storage, namely generation of electricity derived from nuclear power, storage of nuclear fuel; nuclear power production; generation, conversion and storage of energy derived from hydrogen; custom material assembly services for others in the form of the custom manufacture of equipment for nuclear power plants, transportable buildings, machines for nuclear reactors; treatment of materials in the field of nuclear power; cleaning, decontamination, sanitation, maintenance and renovation, of nuclear facilities, and of equipment and apparatus nuclear field.

Class 41

(5) Training, education, instruction, teaching in the field of energy; organization and conduct of colloquia, conventions, seminars, conferences in the field of energy; organization and conduct of training workshops in the field of energy; editing and publishing of books, journals, printed matter, newspapers, magazines, CD-ROMs in the field of energy; correspondence courses in the field of energy; educational institutions and services, namely for continuing education and academic education and further training in the field of energy, namely training, education for the staff and operators of nuclear infrastructure, mining sites, facilities, plants and centres.

Class 42

(6) Engineering, namely engineering work in the fields of nuclear power and climate change; laboratory work, namely laboratory research in the field of chemistry, management of scientific and technological projects, namely engineering work in the fields of energy and electronics; engineering work, namely technical advice in the field of pollution detection, technical advice in the field of environmental science, technical surveying, laboratory work and management of scientific

and technological projects, namely engineering work in the field of energy; engineering work, in the nature of research, development, analysis, study and design work in the field of energy; engineering work, namely advice, assessment and testing of materials in the field of energy; engineering work, namely control and simulation services in the field of energy; engineering work, namely scientific and industrial research, design, study, assessment, advisory and information services related to environmental protection, sustainable development, renewable energies and the fight against climate change; environmental auditing services for sites, installations and equipment in the fields of energy and electronics; design, programming, updating, maintenance and rental of software applied to the field of energy, namely in the fields of renewable energies and the fight against climate change, electronics and cybersecurity; chemistry services, namely chemistry laboratory research in the fields of nuclear power and electronics; engineering work, namely pollution risk prevention services related to activities developed in the fields of energy and electronics; services provided by engineers, namely monitoring of nuclear materials, monitoring services for nuclear equipment and facilities; engineering work, namely monitoring services for plants and centres for the warehousing, storage, processing, isotope separation, reprocessing and recycling of fuels, ores, materials used in the nuclear field, nuclear materials, uranium, plutonium and nuclear waste, and for nuclear power plants, nuclear reactors; computer systems design and security; safety inspection of construction sites; studies related to energy mix projects and their impact on smart electrical power transmission and distribution networks; computer security services for networks and streamed data.

Class 45

(7) Security services, namely monitoring services and security guard services for plants and centres for the warehousing, storage, processing, isotope separation, reprocessing and recycling of fuels, ores, materials used in the nuclear field, nuclear materials, uranium, plutonium and nuclear waste, nuclear power plants, nuclear reactors; inspection of construction sites, namely safety auditing for improving the safety of construction workers on commercial, industrial and institutional construction sites.

Claims

Priority Filing Date: December 17, 2017, Country or Office: FRANCE, Application No: 17 4413918 in association with the same kind of services (2); December 18, 2017, Country or Office: FRANCE, Application No: 17 4413918 in association with the same kind of goods and in association with the same kind of services (1), (3), (4), (5), (6), (7)

Application Number 1,906,373
Language of Application English

Filing Date 2018-06-26

APPLICANT AND AGENT DETAILS

Applicant

DIXON TICONDEROGA COMPANY
2525 North Casaloma Drive
Appleton, Wisconsin 54913
UNITED STATES OF AMERICA

Agent

BORDEN LADNER GERVAIS LLP
World Exchange Plaza, 100 Queen Street,
Suite 1300, Ottawa, ONTARIO, K1P1J9

TRADEMARK DETAILS

CREATIVITY STREET WHERE FUN & IMAGINATION MEET

Trademark Type

Standard Characters

Goods

Class 02

(1) arts and crafts tempera paint sticks, namely, paints in handheld stick form

Class 16

(2) adhesive strips and adhesive dots used to adhere arts and craft findings and other items to paper, foam, and other surfaces; arts and craft paint kits; arts and crafts paint kits, arts and craft clay kits and arts and crafts paper kits, all comprised of markers, crayons, colored pencils, pastels, paints, brushes, scissors and erasers, paint cups and brushes, easels and easel pads, paint sets, oil pastels, chalk, modeling clay, eraser clay, clay for shaping, sculpting and making figures; arts and crafts, namely, cardboard and cardboard die cut shapes, numbers and letters that contain an adhesive back for mounting; cellophane wrap for wrapping and crafts; chalk, chalkboards; chalk holders for holding chalkboard chalk; combination boards, namely, chalkboards and dry erase boards; chalk and dry erase erasers; coiling core for coiling baskets, namely, paper core for use in basket-making arts and crafts; color pencils; corrugated paper boxes for storing and dispensing yarn; craft glue for craft, stationery or household purposes; craft glue pens for craft or stationery purposes; craft glitter glue for craft, stationery or household purposes; crepe paper; paper doilies; dry erase boards; dry erase pockets, namely, sleeves for papers featuring dry erase writing surfaces; embossed paper sheets and embossed paper sheet sets for arts and crafts; empty yarn cones made of paper chipboard to store and dispense yarn; glue sticks for craft, stationery or household use; holders for masking tape; modeling clay; iridescent plastic film for wrapping, packaging, crafts and decoration not for commercial or industrial use; paint applicators in the nature of sponge tipped bottles, foam rollers, foam brushes, sponges; origami paper; notched cardboard patterns and cardboard looms for weaving crafts; paint brushes; paint brush holders; paint trays; paint cups with covers; paint cup covers; paint rollers; paperboard in the shape of eyeglasses for decorating; paper art tape consisting of adhesive backed tape used for craft projects; paper crowns for decorating; paper boxes for decorating; paper mache shapes for arts and crafts decorating purposes, namely, paper mache frames, boxes, bird houses and trunks for decorating; accessories specially designed for modeling clay, namely, plastic body parts and

apparel for decorating, and dough-shaping and dough-cutting tools; pastels; patterned papers in the nature of decorative paper for arts and crafts; plastic sheets for writing, printing, marking, painting, marbling, and for making stencils, and die-cuts; paper tape; rocks for decorating; stickers; stencils; tissue paper; stick-on and magnetic whiteboards; whiteboard erasers; whiteboards in particular shapes, namely, maps, people and faces; hobby craft kit consisting of embossed paper sheets for arts and crafts, chalk, colored pencils, crayons, paint tray, pastels, water color paint set, and instruction sheet; modeling clay;

Class 20

(3) assorted wood shapes for crafting; wood shapes for crafting, namely, shaped wood craft sticks, wood craft sticks with swab end, wood craft clothes pins, wood craft spools, decorative wooden toothpicks, wood picture frames, wood craft dowels, wood craft numbers and letters, wood craft spoons, wood craft pins; wood bases for basket weaving; wood tools for shaping modeling dough and toy clay, namely, rolling pins and shapers; decorative glitter; mirrors; wood boxes; wood door hangers for decoration; wood picture frames; decorative boxes made of plastic; picture frames of paper mache;

Class 26

(4) arts and crafts findings, namely, chenille stems, acrylic gemstones, acrylic letters and shapes, bells, beads for crafts, decorative burlap, buttons, confetti, cords for stringing beads, craft fluffs; beads other than for making jewelry, namely, water permeable beads for decoration and sensory stimulation; synthetic hair for crafting; feathers for ornamentation; plastic craft clasps for craft purposes; decorative plastic mosaic shapes for crafting; plastic needles for stitching or weaving; plastic wiggly eyes, pom poms, sequins, spangles; hobby craft kit consisting of decorative chenille stems, pom poms, wiggly eyes

Class 28

(5) dice; hand puppets; interlocking construction toys; paper and paperboard face masks; paper mache face masks; puzzles; soft sculpting foam shaping toy; spinning tops; toy building blocks; toy modeling dough; toy and novelty face masks; toy tools including toy cutters; toy modeling dough; accessories specially designed for toy modeling dough, namely, plastic toy body parts and apparel for decorating, and toy modeling doughshaping and dough-cutting knives; children's toys in the nature of wax sticks and waxed shapes that are bendable and self-sticking to each other and to surfaces; return tops; toy hobby craft kit, namely, kit for making a decorative door hanger consisting of chenille stems, craft glue, foam door hangers, feathers, glitter glue pens, sequins, spangles; toy hobby craft kit consisting of chenille stems, craft fluffs, craft glitter glue pens, dough cutters, modeling clay, feathers, felt sheets, glitter, pom poms, sequins, spangles, wiggly eyes, acrylic gemstones, buttons, beads, rainbow cord for stringing beads, wooden craft sticks, foam shapes and sheets; toy hobby craft kit for making toy foam novelty flags, namely, flag kit consisting of foam sheets, foam stars and foam stripes; toy hobby craft kit for making toy and novelty face masks, namely, mask kit consisting of masks, synthetic hair for crafting, feathers, and glitter glue pens; toy hobby craft kit, namely, a toy modeling dough kit consisting of toy modeling dough, dough cutters and dough tools; toy hobby craft kit, consisting of wax sticks and waxed shapes that are bendable and self-sticking to each other and to surfaces, chenille stems, craft fluffs, craft glitter glue pens, synthetic hair for crafting, wooden craft sticks, pom poms, sequins, spangles, wiggly eyes; toy hobby craft kit for early learning and special needs purposes, namely, wax sticks and waxed shapes that are bendable and self-sticking to each other and to surfaces, chenille stems, construction paper, craft fluffs, craft glitter glue pens, synthetic hair for crafting, wooden craft sticks, pom poms, sequins, spangles, wiggly eyes and lesson plans; paper mask kit consisting of paper masks with scratch off coating, elastic cords and etching sticks; toy hobby craft kit consisting

of paper book marks, ribbon and beads; toy hobby craft kit consisting of cardboard and cardboard die cut shapes that contain an adhesive back for mounting, beads, chenille stems, feathers, foam shapes, glitter, sequins, spangles, wiggly eyes; toy hobby craft kit consisting of paper crowns for decorating, paper eyeglasses for decorating, paper collage boards, sequins, colored pencils, glitter and blank certificates; toy hobby craft kit consisting of acrylic gemstones, paper mache boxes, craft glue, feathers, glitter glue pens, pom poms, foam shapes, sequins, spangles; book mark hobby craft kit, namely, kits for making book marks consisting of beads, decorative cord and foam; toy hobby craft kit for making and decorating toy puppets consisting of paper bags and canvas puppets, and arts and crafts findings and other items for decorating puppets, namely chenille stems, feathers, foam shapes, glitter, sequins, spangles, wiggly eyes; toy hobby craft kit consisting of modeling clay, chenille stems, craft fluffs, craft glitter glue pens, dough cutters, feathers, felt sheets, glitter, pom poms, sequins, spangles, wiggly eyes, acrylic gemstones, buttons, beads, rainbow cord for stringing beads, wooden craft sticks, foam shapes and sheets; toy hobby craft kit consisting of assorted wood shapes, namely, wooden craft sticks, building sticks, spoons, wooden dowels and instruction sheets; toy hobby craft kit for making decorated picture frames, consisting of paper mache picture frames, acrylic gemstones, craft glitter glue pens, feathers, foam shapes, sequins.

Claims

Priority Filing Date: January 25, 2018, Country or Office: UNITED STATES OF AMERICA,
Application No: 87/770,360 in association with the same kind of goods

Application Number 1,907,295
Language of Application English

Filing Date 2018-06-26

APPLICANT AND AGENT DETAILS

Applicant

Mernova Medical Inc.
128 Brook Street
Lake Fletcher
NOVA SCOTIA
B2T1A5

Agent

COX & PALMER
PO BOX 2380 CENTRAL, Nova Centre - South
Tower, 1500 - 1625 Grafton Street, HALIFAX,
NOVA SCOTIA, B3J0E8

TRADEMARK DETAILS

Ritual Green

Trademark Type

Word

Goods

Class 05

(1) Nutraceuticals containing cannabis and cannabis derivatives; nutraceutical supplements containing cannabis and cannabis derivatives; animal feed supplements.

Class 30

(2) Snack foods namely, potato chips, potato-based, wheat-based, starch based, corn chips, corn-based, popcorn, sweet potato chips, sweet potato based, granola-based, rice-based, cereal-based all containing cannabis derivatives; candies, chocolate, chocolates, chocolate bars, chocolate mints, chocolate confectionery; sugar confectionery, cotton candy, marshmallows, candies and biscuits all containing cannabis derivatives.; Baked goods made with cannabis derivatives, namely, cakes, cookies, biscuits, crackers, brownies, muffins, cupcakes, donuts, pies, bread and buns, matzo/ unleavened bread, pastries, ice cream cones, cereal bars, energy bars, granola bars.; Condiments namely, maple syrup, golden syrup, table syrup, pancake syruo and corn based syrups, ketchup, relish, mustard, chutney, mayonnaise, horseradish, hot sauce, chili paste, hemp paste, soya bean paste, salad dressings, clear vinegar, beer vinegar and malt vinegar, soya sauce, pesto, apple sauce all infused with cannabis or derivatives.

Class 31

(4) Animal feed

Class 32

(3) Non-alcoholic beverages infused with cannabis, cannabis extracts, cannabis resins, cannabis oils, cannabis tinctures, cannabis waxes and derivatives, namely, fruit-flavoured beverages, carbonated beverages, energy drinks, protein-enriched sports beverages, sports beverages, smoothies; water, namely, mineral and carbonated waters.

Application Number 1,907,654
Language of Application English

Filing Date 2018-07-04

APPLICANT AND AGENT DETAILS

Applicant

RMA Global Limited
PO Box 4556, Richmond East
Victoria, 3121
AUSTRALIA

Agent

BENNETT JONES LLP
SUITE 3400, ONE FIRST CANADIAN PLACE,
P.O. BOX 130, TORONTO, ONTARIO,
M5X1A4

TRADEMARK DETAILS

Trademark Type

Design

Visual Representation



Services

Class 35

(1) Preparing, collating and providing ratings, reviews and recommendations pertaining to real estate agents, real estate agencies, rental property managers, and service providers in the real estate market and the real estate industry to consumers for commercial purposes; business and commercial research, assessment, review and ranking of real estate agents and real estate agencies and aligned service providers for commercial purposes; business and commercial research, assessment, review and ranking of real estate agents according to various criteria, including but not limited to number of current and sold listings, time to sell property, accuracy of quote, type of property sold, average sale price of property, consumer feedback and ratings, the foregoing for commercial purposes; provision of referrals to real estate agents and real estate agencies

Class 36

(2) Financial and monetary affairs, namely, financial information in the field of real estate purchase, management and analysis services; real estate agency services; real estate consultancy; provision of information relating to real estate; provision of real estate listing information; Providing information in the field of real estate; provision of financial market analysis data pertaining to the

real estate industry, including specific data pertaining to the sales performance of real estate agents and real estate agencies; providing financial information, namely, information about home loans; providing insurance information; information, advisory and consultancy services in relation to real estate investment; providing real estate agency services and information relating to real estate via a global computer network

Claims

Priority Filing Date: April 26, 2018, Country or Office: AUSTRALIA, Application No: 1922576 in association with the same kind of services

Application Number 1,909,513
Language of Application English

Filing Date 2018-07-10

APPLICANT AND AGENT DETAILS

Applicant

Liteline Corporation
90 West Beaver Creek Road
Richmond Hill
ONTARIO
L4B1E7

Agent

BRUNO P. SOUCY
(Blaney McMurtry LLP), The Maritime Life
Tower, Suite 1500, 2 Queen Street East,
Toronto, ONTARIO, M5C3G5

TRADEMARK DETAILS

Trademark Type

Position

Visual Representation



Trademark Description

The trademark consists of the position of the colour blue (PANTONE PMS300) applied to the outer visible surface of the packaging, on areas shown in the visual representation. (PANTONE is a registered trademark) The object shown in dashed lines does not form part of the trademark but is included merely to show the position of a sign.

Colour Claim

Colour is claimed as a feature of a trademark. The trademark consists of the position of the colour blue (PANTONE PMS300) applied to the outer visible surface of the packaging, on areas shown in the visual representation (PANTONE is a registered trademark).

Goods

Class 09

(1) Electric light dimmers; electric light switches; electrical control systems for lighting systems; light dimmers; light switches.

Class 11

(2) Compact fluorescent light bulbs; electric discharge tubes for lighting; electric torches for lighting; electric track lighting units; fluorescent lighting fixtures; halogen light bulbs; incandescent light bulbs; infrared lighting fixtures; led landscape lights; led light bulbs; light bulbs; light diffusers; light globes; lighting fixtures; lights for wall mounting; sconce lighting fixtures.

Class 16

(3) Printed publications, namely flyers, books, magazines, manuals, newsletters, handbooks.

Application Number 1,912,674
Language of Application English

Filing Date 2018-07-31

APPLICANT AND AGENT DETAILS

Applicant

Gaming Laboratories International, LLC
600 Airport Road
Lakewood , NJ 08701
UNITED STATES OF AMERICA

Agent

MCCARTHY TETRAULT LLP
745 Thurlow Street, Suite 2400, VANCOUVER,
BRITISH COLUMBIA, V6E0C5

TRADEMARK DETAILS

GLI

Trademark Type

Word

Services

Class 35

(1) Business auditing in the nature of electronic gaming and lottery devices, gaming, lottery and pari-mutuel systems and consulting services related thereto; business auditing; business auditing in the fields of gaming, iGaming, gambling, Internet gambling, lottery, pari-mutuel, esports, sports wagering, and consulting services related thereto; business consultancy services relating to business continuity, disaster planning and recovery; information, advisory, support and consultancy services in the fields of business continuity, disaster planning and recovery, and business auditing

Class 41

(2) Educational and training services in the fields of electronic gaming, video gaming, iGaming, gambling, internet gambling, lottery, pari-mutuel, esports, and sports wagering; online educational and training services in the fields of electronic gaming, video gaming, iGaming, gambling, internet gambling, lottery, pari-mutuel, esports, and sports wagering; training and educational services in the fields of computer hardware, computer software, information technology (IT) systems namely computer and computer network systems, information technology (IT) services namely computer and computer network services, and cyber security; arranging and conducting seminars, classes, workshops and training sessions in the fields of computer hardware, computer software, information technology (IT) systems namely computer and computer network systems, information technology (IT) services namely computer and computer network services, and cyber security; providing information and training in the fields of iGaming, gambling, internet gambling, lottery, pari-mutuel, esports, and sports wagering; information, advisory, support and consultancy services in the fields of iGaming, gambling, internet gambling, lottery, pari-mutuel, esports, and sports wagering

Class 42

(3) Scientific and technological services, namely, analysis and testing of goods and services of others in the fields of electronic gaming, video gaming, iGaming, gambling, internet gambling, lottery, pari-mutuel, esports, and sports wagering, and research and design relating thereto; scientific and technological services, namely, analysis and testing of goods and services of others

in the fields of electronic gaming, video gaming, iGaming, gambling, internet gambling, lottery, pari-mutuel, esports and sports wagering to determine conformity with certification standards; scientific and technological services, namely, testing, analysis and evaluation of the services of others to determine conformity with certification standards; scientific and technological services, namely, testing, analysis, and evaluation of goods or services of others in the fields of gaming, iGaming, gambling, internet gambling, lottery, pari-mutuel, esports and sports wagering to the order and specification of businesses, governments, and regulatory entities; scientific and technological services, namely, analysis and testing of goods and services in the fields of electronic gaming, video gaming, iGaming, gambling, internet gambling, lottery, pari-mutuel, esports and sports wagering, and research and design relating thereto; industrial analysis and research services, namely, research, testing, analysis, and evaluation of goods and services of others to assure compliance with industry, regulatory, legal, business and certification standards; industrial analysis and research services, namely, research, testing, analysis, and evaluation of goods and services of others to determine conformity with certification standards; industrial analysis and research services, namely, evaluation of goods or services of others in the fields of gaming, iGaming, gambling, internet gambling, lottery, pari-mutuel, esports and sports wagering to the order and specification of businesses, governments, and regulatory entities; industrial analysis and research services, namely, research, testing, analysis, and evaluation of goods and services of others to assure compliance with industry, regulatory, legal, business and certification standards in the fields of gaming, iGaming, gambling, internet gambling, lottery, pari-mutuel, esports and sports wagering; services of quality control and testing of electronic game apparatus, of programs for electronic games, of lottery games and games of chance on behalf of national or governmental gaming regulatory authorities; certification services, namely, services of checking legality and approval of electronic game apparatus, of programs for electronic games, of lottery games and games of chance on behalf of national or governmental gaming regulatory authorities; technological certification services, namely, services of checking legality and approval of electronic game apparatus, of programs for electronic games, of lottery games and games of chance on behalf of national or governmental gaming regulatory authorities; testing and inspecting the functionality of electronic gaming and lottery devices, gaming lottery and pari-mutuel systems and associated equipment and consulting services related thereto; testing, analysis and evaluation of gaming equipment and gaming software of others for the purpose of certification obtained over a wireless communication device; providing remote testing, checking and certifying services in relation to gaming machines, electronic game apparatus, electronic games, lottery games, games of chance, slot machines and video slot machines; information technology (IT) consulting services, namely, consulting services in the fields of computer and computer network systems and services; IT compliance management, namely, testing, analysis, and evaluation of the software and information technology (IT) systems namely computer and telecommunication systems, of others to assure compliance with industry and certification standards; quality auditing, namely, product quality testing services in the fields of electronic gaming, video gaming, iGaming, gambling, internet gambling, lottery, pari-mutuel, esports and sports wagering; IT certification services, namely, testing, analysis and evaluation of information technology (IT) systems namely computer and telecommunication systems of others to determine conformity with certification standards; certification services for computer hardware, computer software, information technology (IT) systems namely computer and telecommunication systems, information technology (IT) services namely computer and telecommunication services, data and cyber security; testing, auditing, analysis and evaluation services for the certification of computer hardware, computer software, information technology (IT) systems namely computer and telecommunication systems, information technology (IT) namely computer and telecommunication, data and cyber security; information, advisory, support and consultancy services in the fields of computer hardware,

computer software, and the testing, analysis and certification of goods and services of others in the fields of electronic gaming, video gaming, iGaming, gambling, internet gambling, lottery, and pari-mutuel

Class 45

(4) Security incident response and investigation services; reviewing standards and practices to assure compliance with laws and regulations in the fields of gaming, iGaming, gambling, internet gambling, parimutuel, lottery, esports, and sports wagering; interviewing of staff for security purposes; conducting staff interviews to assess and ascertain the unauthorised accessibility of sensitive information and data; physical security consulting services, namely, reviewing training material and records to assess and ascertain the unauthorised accessibility of sensitive information and data for businesses and organizations; information, advisory, support and consultancy services relating to compliance with laws and regulations in the fields of gaming, iGaming, gambling, internet gambling, pari-mutuel, lottery, esports, and sports wagering

Application Number 1,915,253
Language of Application English

Filing Date 2018-08-16

APPLICANT AND AGENT DETAILS

Applicant

Varsinais-Suomen sairaanhoitopiirin
kuntayhtymä
PL 52
20521 Turku
FINLAND

Agent

ANDREWS ROBICHAUD
1673 Carling Avenue, Suite 215, Ottawa,
ONTARIO, K2A1C4

TRADEMARK DETAILS

Trademark Type

Design

Visual Representation



Colour Claim

Colour is claimed as a feature of the trade-mark. Text and design is in Green. Tip of flower is in Purple. Background is white.

Services

Class 41

(1) Health and wellness coaching for healthcare workers in the form of theoretical and practical training sessions for treating children; Health and wellness training for parents whose child is ill in the form of theoretical and practical training sessions for treating children: Medical education and training for healthcare workers in the form of theoretical and practical training sessions for treating children; Medical education and teaching parents whose child is ill in the form theoretical and practical training sessions for treating children.

Class 44

(2) Hospital services and medical clinic services for children; Medical health counseling services for parents whose child is ill

Claims

Priority Filing Date: March 22, 2018, Country or Office: EUIPO (EU), Application No: 017878484 in association with the same kind of services

Application Number 1,915,728
Language of Application English

Filing Date 2018-08-20

APPLICANT AND AGENT DETAILS

Applicant

Hedera Hashgraph, LLC
224 W. Campbell Rd.
Suite 504
Richardson, Texas 75080
UNITED STATES OF AMERICA

Agent

SMART & BIGGAR LLP
1100-150 York street, TORONTO, ONTARIO,
M5H3S5

TRADEMARK DETAILS

HEDERA

Trademark Type

Word

Goods

Class 09

computer software platforms for distributed consensus computing, namely, distributed ledger technology (DLT) consensus computations; computer application software for distributed ledger based platforms, namely, software for using a consensus engine incorporating distributed ledger technology for cryptographically securing data

Services

Class 35

(1) online retail store services featuring computer software provided via the internet and other computer and electronic communication networks; office functions, namely, managing computer networks, namely, computer networks with distributed ledger based platforms; promoting public awareness of distributed ledger technology

Class 41

(2) educational services, namely, providing training in the fields of computer software and distributed ledger technology

Class 42

(3) design, development, and implementation of software for distributed computing platforms; design, development, and implementation of software for distributed ledger technology; research and development of computer software; software development and product development consulting in the field of distributed computing platforms; providing information about distributed ledger software via a website; software as a service (SAAS) services featuring software for distributed ledger technology, cryptocurrency, virtual currency, and digital tokens; platform as a service featuring computer software platforms for distributed ledger technology and authenticating, facilitating and processing data in the fields of cryptocurrency, virtual currency, and digital tokens; providing information in the fields of computer software and distributed ledger technology

Claims

Priority Filing Date: February 20, 2018, Country or Office: UNITED STATES OF AMERICA,
Application No: 87/803,631 in association with the same kind of goods and in association with the
same kind of services

Application Number 1,918,167
Language of Application English

Filing Date 2018-09-04

APPLICANT AND AGENT DETAILS

Applicant

Yung Gravy, LLC
16 West 22nd Street
2nd Floor
New York, NY 10010
UNITED STATES OF AMERICA

Agent

LORRAINE M. FLECK
WeirFoulds LLP, 4100 - 66 Wellington Street
West, PO Box 35, TD Bank Tower, Toronto,
ONTARIO, M5K1B7

TRADEMARK DETAILS

YUNG GRAVY

Trademark Type

Standard Characters

Authorisation For Use

Consent from Matthew Raymond Hauri, known professionally as Yung Gravy, is of record.

Goods

Class 09

(1) Digital materials, namely, downloadable audio files featuring pre-recorded musical performances of musical compositions and sound recordings; downloadable musical video recordings; downloadable musical sound recordings.

Class 25

(2) Clothing, namely hats, headwear, namely, head bands, head scarves, caps, beanies, visors, bucket hats and bandannas, sweatshirts, sports Jerseys, tee-shirts;

Services

Class 41

Entertainment services by a musical artist and producer, namely, musical composition for himself and others and production of musical sound recordings for himself and others; Entertainment, namely, live performances by a musical artist; Entertainment services in the nature of live musical performances; Entertainment services in the nature of live vocal performances by a musical artist; Entertainment services in the nature of live audio performances by a musical artist; Entertainment services, namely, personal appearances by a musical artist, music producer, or musical group; Entertainment services, namely, non-downloadable pre-recorded music via a global computer network; Production of musical sound recording; Production of sound and music video recordings.

Claims

Priority Filing Date: March 02, 2018, Country or Office: UNITED STATES OF AMERICA, Application No: 87817782 in association with the same kind of goods (1); March 02, 2018, Country or Office: UNITED STATES OF AMERICA, Application No: 87817798 in association with the same kind of services; March 02, 2018, Country or Office: UNITED STATES OF AMERICA, Application No: 87818047 in association with the same kind of goods (2)

Application Number 1,919,070
Language of Application French

Filing Date 2018-09-10

APPLICANT AND AGENT DETAILS

Applicant

Philippe Côté
6750 Avenue De L'esplanade
#240
Montréal
QUÉBEC
H2V4M1

Agent

BENOÎT & CÔTÉ INC.
560 boul. Crémazie Est, 3e étage, Montréal,
QUÉBEC, H2P1E8

TRADEMARK DETAILS

PICOBO

Trademark Type

Word

Goods

Class 09

(1) Computer programs and software, namely downloadable entertainment software, applications and programs featuring virtual board games and video games; computer programs and software, namely downloadable software, applications and programs for developing virtual board games and video games; video game cartridges; teaching robots, namely laboratory robots; personal digital assistants (PDAs), downloadable graphics for mobile telephones; measuring instruments, namely energy consumption sensors for household electronics.

Class 28

(2) Toys and games, namely board games, puzzle games, strategy games, dexterity games, action skill games, educational games and toys, tabletop games, hand-held games with liquid crystal displays, portable games with liquid crystal displays, chess games, card games, playing cards, building blocks, robots, puzzles, dice games, computerized tabletop video games, pet toys; electronic hand-held game units; hand-held electronic video games; stationary training bikes; amusement park rides; teaching robots, namely toy robots; playground games, namely playground slides.

Services

Class 41

(1) Teaching, educational and instructional services, namely organization of colloquia, workshops, classes and conferences in the entertainment field related to puzzle games, strategy games and educational games; cultural entertainment services in the entertainment field, namely production of puzzle games, strategy games and educational games; cultural entertainment services in the entertainment field, namely provision of puzzle games, strategy games and educational games (online); provision of video games and board games (online); supplying of video games and board games (online).

Class 42

(2) Software as a service (SaaS) for the operation of online board games and video games, namely software as a service for the development of virtual board games and video games; design and development of virtual board game and video game software; computer platform as a service (PaaS) for the operation of online board games and video games; design of computer systems for the operation of video games and board games.

Application Number 1,919,290
Language of Application English

Filing Date 2018-09-11

APPLICANT AND AGENT DETAILS

Applicant

ALO, LLC
6670 Flotilla Street
Commerce, CA 90040
UNITED STATES OF AMERICA

Agent

GOWLING WLG (CANADA) LLP
SUITE 2600, 160 ELGIN STREET, OTTAWA,
ONTARIO, K1P1C3

TRADEMARK DETAILS

AIRLIFT

Trademark Type

Standard Characters

Goods

Class 25

Clothing, namely, bottoms, namely, shorts, pants, lounge pants, sweatpants, tights, leggings

Claims

Priority Filing Date: April 09, 2018, Country or Office: UNITED STATES OF AMERICA, Application No: 87/869,182 in association with the same kind of goods

Application Number 1,920,826
Language of Application English

Filing Date 2018-09-19

APPLICANT AND AGENT DETAILS

Applicant

Neutron Holdings, Inc.
85 Second Street
Suite 100
San Francisco, CA 94105
UNITED STATES OF AMERICA

Agent

GOWLING WLG (CANADA) LLP
TD Canada Trust Tower, Suite 1600, 421 -7
Avenue SW, Calgary, ALBERTA, T2P4K9

TRADEMARK DETAILS

LIME

Trademark Type

Word

Goods

Class 09

Downloadable software for reservation management in the field of vehicle sharing and rental services.

Services

Class 39

(1) Vehicle sharing services; rental of bicycles, scooters, and electric and motor vehicles; providing a website featuring vehicle rental and sharing information; transportation consulting services related to vehicle rental and sharing; reservation services for vehicle rental and sharing.

Class 42

(2) Software as a Service (SaaS) provider in the field of reservation management for vehicle sharing and rental services.

Claims

Priority Filing Date: June 21, 2018, Country or Office: UNITED STATES OF AMERICA, Application No: 88/010478 in association with the same kind of goods and in association with the same kind of services

Application Number 1,922,128
Language of Application English

Filing Date 2018-09-26

APPLICANT AND AGENT DETAILS

Applicant

Products Unlimited, Inc.
915 N 43rd Ave
Omaha, NE 68131
UNITED STATES OF AMERICA

Agent

KIMBERLEY CUNNINGHAM
(BENNETT JONES LLP), 3200 TELUS
HOUSE, SOUTH TOWER, 10020 - 100TH
STREET, EDMONTON, ALBERTA, T5J0N3

TRADEMARK DETAILS

Trademark Type

Position

Visual Representation



Trademark Description

The trademark consist of the position of generally diamond-shaped apertures in which a column of generally diamond-shaped apertures is slightly offset from another column to either side, the goods are shown with a dashed outline and do not form part of the trademark but is included merely to show the positioning of the trademark.

Goods

Class 11

Air filters for furnaces, air conditioners, room air purifiers, air humidifiers and dehumidifiers, and other industrial and commercial uses and installations namely filters for paint booths.

Claims

Priority Filing Date: September 05, 2018, Country or Office: UNITED STATES OF AMERICA, Application No: 88104887 in association with the same kind of goods

Application Number 1,922,437
Language of Application English

Filing Date 2018-09-27

APPLICANT AND AGENT DETAILS

Applicant

John Robert Davy and Marisa Peer
848 N. Rainbow Blvd, #3358
Las Vegas, NV 89107
UNITED STATES OF AMERICA

Agent

MBM INTELLECTUAL PROPERTY LAW LLP
275 SLATER STREET, 14TH FLOOR,
OTTAWA, ONTARIO, K1P5H9

TRADEMARK DETAILS

RTC

Trademark Type

Word

Authorisation For Use

Consent from Société de transport de Québec is of record.

Services

Class 41

Educational services in the fields of personal development and professional development; providing of training in the fields of personal development and professional development; education services, namely, providing live and on-line classes, seminars, workshops in the field of personal development and the distribution of course and training materials in connection therewith; training services in the field of personal development; membership club services, namely, providing training to members in the field of professional development

Claims

Priority Filing Date: April 23, 2018, Country or Office: EUIPO (EU), Application No: 017890982 in association with the same kind of services

Application Number 1,922,541
Language of Application English

Filing Date 2018-09-28

APPLICANT AND AGENT DETAILS

Applicant

Id Software LLC
1500 N Greenville Ave #700
Richardson, TX 75081
UNITED STATES OF AMERICA

Agent

DLA PIPER (CANADA) LLP
1 FIRST CANADIAN PLACE, SUITE 6000, P.
O. BOX 367, 100 KING STREET WEST,
TORONTO, ONTARIO, M5X1E2

TRADEMARK DETAILS

COMMANDER KEEN

Trademark Type

Standard Characters

Goods

Class 09

Mobile application software, namely, electronic game programs; computer game software for use with online interactive games; video games for mobile devices, electronic game programs; downloadable electronic game programs; electronic game software; computer game programs; downloadable computer game programs; interactive game programs; interactive game software; downloadable computer game software Page 3 of 4 offered via the internet and wireless devices; Computer game software for use with computers and video game consoles; downloadable computer and video game software offered via the internet and wireless devices; electronic devices featuring computer game software for use with computers and video game consoles; pre-recorded digital media in the nature of CD-ROMs and DVDs featuring computer games and video games, wallpapers, screensavers, digital music files, and graphics, videos, films, multimedia files, motion pictures, and animation in the field of video games and computer games; downloadable digital media, namely, downloadable images, downloadable artwork, downloadable text messages, downloadable messages, downloadable films, graphics, music, downloadable game software, and downloadable motion pictures.

Services

Class 41

Entertainment services, namely, providing on-line interactive computer games; online interactive games accessible via mobile phones and wireless devices; entertainment services, namely, providing information and entertainment in the nature of news, information, non-downloadable art pictures, non-downloadable video clips, and non-downloadable trailers relating to electronic computer games via the Internet; Providing non-downloadable electronic publications in the nature of books, magazines, journals and newspapers in the field of novels, comics and cartoons; movie film production; movie film distribution; television productions: rental of amusement machines and apparatus, namely video game consoles and digital media namely video games, computer games, motion pictures and animated films in the field of video games and computer games; rental of game machines and apparatus, namely video game consoles and digital media namely video games, computer games, motion pictures and animated films in the field of video games and computer games.

Claims

Priority Filing Date: August 02, 2018, Country or Office: HONDURAS, Application No: 33905-2018 in association with the same kind of services; August 02, 2018, Country or Office: HONDURAS, Application No: 33904-2018 in association with the same kind of goods

Application Number 1,922,981
Language of Application English

Filing Date 2018-10-01

APPLICANT AND AGENT DETAILS

Applicant

Academy Soccer Coach Limited
Archer House, Britland
Northbourne Road
Eastbourne
East Sussex BN22 8PW
UNITED KINGDOM

Agent

MARKS & CLERK
180 Kent Street, Suite 1900, Ottawa,
ONTARIO, K1P0B6

TRADEMARK DETAILS

Trademark Type

Design

Visual Representation

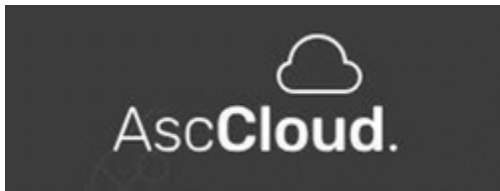

Goods

Class 09

computer software for sports education, training and coaching; mobile application software for sports education, training and coaching; downloadable computer software applications for sports education, training and coaching; downloadable mobile applications for sports education, training and coaching; education software for sports training and coaching; electronic publications in the nature of pdf files, video files, digital diagrams and images on the topic of sports education, training and coaching; downloadable radio podcasts; downloadable video recordings featuring sports and exercise instruction; downloadable electronic reports on the topic of sports education, training and coaching; downloadable electronic newsletters; downloadable educational course materials, namely pdf files, video files, digital diagrams and images for sports education, training and coaching; downloadable sports session templates; downloadable e-books; downloadable sports coaching journals; downloadable interactive software for sports education, training and coaching; prerecorded CDs and DVDs containing audio and video clips in the field of sports and physical education and training for coaches; wearable activity trackers; wearable video display monitors; smart watches; downloadable software relating to sports education; computer software for the coaching of disability sports; computer software for physical education

Services

Class 41

(1) providing non-downloadable video recordings for coaches in the nature of sports and physical education and training; provision of non-downloadable electronic publications in the nature of pdf files, video files, digital diagrams and images for sports education, training and coaching;

publication of educational books; publishing of electronic books and journals online; providing educational courses and resources in the field of sports education, training and coaching; sports training and coaching provided by way of a virtual computer simulator; sports coaching; arranging and conducting conferences in the field of sports education, training and coaching; providing coaches with educational information and resources in the field of sports training and coaching; rental of sports equipment, except vehicles; providing sports facilities; providing workshops in the field of sports education, training and coaching; providing non-downloadable digital educational sports training and coaching session templates and plans; provision of non-downloadable sports session templates; sports lesson planning; providing advisory, consultancy and information services in the fields of sports education, training and coaching

Class 42

(2) providing non-downloadable computer software in the field of sports education, training and coaching; research, design and development of computer hardware and software; web hosting; providing nondownloadable software for mobile devices in the field of sports education, training and coaching; consultation services relating to computer software for sports education, training and coaching; software as a service [SaaS] in the field of sports education, training and coaching; computer programming; computer programming consultancy; rental of a database server to third parties; electronic storage of data relating to sports education, training and coaching; hosting of websites; cloud computing web hosting services; cloud hosting provider services; design and development of operating software for cloud computing networks; providing information on computer technology and programming via a website; providing online nondownloadable software relating to sports education; providing online non-downloadable computer Software for the coaching of disability sports; providing online non-downloadable software for physical education

Application Number 1,923,115
Language of Application English

Filing Date 2018-10-02

APPLICANT AND AGENT DETAILS

Applicant
ALTANA AG
Abelstr. 43
46483 Wesel
GERMANY

Agent
OSLER, HOSKIN & HARCOURT LLP
SUITE 1900, 340 ALBERT STREET,
OTTAWA, ONTARIO, K1R7Y6

TRADEMARK DETAILS

ALTANA

Trademark Type
Word

Goods

Class 01

(1) Chemical products and chemical substances for production processes, namely, for the production of paints, coatings, varnishes, adhesives, inks, sealants, cosmetics, homecare and personal care products, plastics, cement and for use in the construction industry; chemical additives for use in the processing of paints, coatings, varnishes, adhesives, inks, sealants, cosmetics, homecare and personal care products, plastics, cement and for use in the construction industry; silicates, namely aluminium silicate, calcium silicate, sodium silicate and zinc silicate; chemical products for gelling; chemical additives, namely, inflating and thickening agents, thixotropic agents for materials in suspension; bentonite; emulsifying agents, namely emulsifying agents for use in the manufacture of inks, paints, cosmetics and home care and personal care products; hardeners, namely hardener for use in the manufacture of inks, paints, cosmetics and home care and personal care products, dispersing agents, namely dispersing agents for use in the manufacture of inks, paints, cosmetics and home care and personal care products; surface active agents for paints and lacquers (tensides); unprocessed synthetic resins and plastics; polyurethane adhesives; synthetic resin adhesives for industrial purposes, general use adhesives, adhesives for use in the construction industry; adhesives for the manufacture of adhesive tapes; silicones; catalysts, namely catalysts for use in the manufacture of industrial chemicals; chemical additives for resins; unprocessed synthetic resins and unprocessed artificial resins, thermosetting resins and plastics, namely thermally curable unprocessed industrial chemicals; unprocessed epoxy resins; unprocessed epoxy polyurethane resins; reaction resins (unprocessed synthetic resins); artificial resins in a raw state; plastic materials in a raw state; plastic materials in sheets, slabs and rods as semi-finished products; synthetic resins as semi-finished products; emulsifiers for resins; wetting agents, namely wetting agents for use in the manufacture of inks, paints, cosmetics and home care and personal care products; liquid elastomers, thermoplastic elastomers, plastisols, polyvinyl chloride plastisols; common metals and their alloys in the form of grit, sequins and powders and pastes made from these powders for painters, decorators and industrial purposes, in particular for the paint and lacquer industry, the printing ink industry, the inkjet printing ink industry, the coating industry, the cosmetics industry, the plastics industry and for the chemical industry; glass in the form of grit, sequins and powders and pastes made from these powders for painters, decorators and industrial purposes, in particular for the paint and lacquer industry, the printing ink industry, the

inkjet printing ink industry, the coating industry, the cosmetics industry, the plastics industry and for the chemical industry.

Class 02

(2) Paints, namely, aluminium, anti-corrosive, anti-fouling, acrylic paints; varnishes, namely, bitumen, floor protection, copal varnishes; lacquers, namely, aluminium, anti-corrosive, anti-fouling, acrylic; powder coatings and powder paints for preventing corrosion, creating texture, creating scratch-resistant surfaces, creating matt surfaces; anti-corrosives, namely anticorrosive greases, oils, paints and waxes; antirust preparations for coating plated and ferrous surfaces to prevent rusting; dyes for preventing corrosion, coating plated and ferrous surfaces to prevent rusting; unprocessed natural resins; wire enamel; gum resins; natural resins for coatings; coatings based on natural resins for metals, and paper; binding agent for paints based on resins; agents and compounds for drying paints and lacquers; thinning and thickening agents for paints, lacquers and ink; binding agents, thickeners, fixing agents for paints and lacquers; aluminium paints; pigments, in particular iron pigments, pearl gloss pigments, metal effect pigments, interference pigments; metals in foil and metals in powder form for painters and decorators; printing pastes (ink) for printers, printing liquid (inks) for printers; inks for printing purposes; inks in cartridges, namely filled ink cartridges for printers; printing paints containing metal effect pigments; thermoplastic elastomers based on styrol block copolymers; polyvinyl chloride plastisols for hot-dip applications;

Class 06

(3) Cut up foils made of common metal in regular forms, in particular in leaf shape; foils made of common metals (not for painters, decorators or insulating purposes).

Class 07

(4) Embossing printing machines, flexographic printing machines, printing machines for use on sheet metal, 3D printers, thermal label printing machines, other than for office use; digital printing machines for decorating cans and glasses; printing presses, printing rollers (machine parts), print heads for printers (machine parts); dispensing valves being machine parts, thermostatic control valves for machines; printing filters of textile materials (machine parts); paper coating machines; adhesive tape dispensing machines; embossing printing machines; pneumatic conveyors, hydraulic accumulators being parts of machines; sealing joints (parts of machines); sealing machines for industrial packaging; mechanical seals.

Class 09

(5) Measuring and testing apparatus and instruments, including their parts and accessories of the afore mentioned goods, namely apparatus for measuring the thickness, viscosity, gloss level and surface structure of colour, apparatus for the analysis of physical properties of coatings and plastics; digital thermometers; infrared thermometers; graduation checkers for calibration purposes; data processing apparatus and computers, namely computer monitors, computer keyboards, computer input devices, namely, DC input power supplies and computer dispensers, computer memory and computer function extension devices, namely, memory and function expansion units and computer interfaces for transmitting measuring data to external computer; computer operating software; electric and electronic controllers for printing machines, paper coating machines and sealing machines; digital process control units for printing machines, paper coating machines and sealing machines; 3D printers, colour printer, digital colour printers, impact printers, thermal printers, colour laser printers; electrical conductors for electric motors and electrical circuit boards.

Class 17

(6) Insulation material made of natural rubber, gutta-percha, rubber or mica; natural rubber, gutta-percha, rubber, mica and goods made from these materials, namely adhesive sealants, sealants for bottle, glass and can caps, seals for medical and pharmaceutical packaging, rubber solutions, insulators for electric wires, insulation paints; mica, in particular synthetic mica, also coated in the form of powders, plates, flakes, pellets or granules as well as in the form of pastes for printers and artists and for industrial purposes (included in this class); goods made of plastics (semi manufactures), namely plastic sheeting for general industrial or manufacturing use; sealing, packing and insulating materials, namely, insulating tapes, foils, insulating plaster, insulating covers, lids and caps for industrial packaging containers, packing material for forming seals for medical and pharmaceutical packaging, insulating coatings; wiper seals (non-metallic); liquid material for electric insulation; electrical insulation articles and materials; sealants for bottles, glasses and can caps; sealing tapes; rubber sheets, silicone rubber compositions; adhesive tapes (not for medical purposes, for paper, or household purposes); adhesive tapes for electrical insulating purposes; synthetic resins in liquid form as semi-finished products, namely synthetic resins in liquid form for use in manufacture; synthetic, conductive and thermosetting resins (semi-finished products); elastomer polymers (semi-finished product), namely elastomeric polymers in form of sheets for use in manufacture.

Class 21

(7) Powdered glass for decoration; glass rods; pressed glass.

Services**Class 37**

(1) Maintenance, servicing, repair and cleaning of embossing printing machines, flexographic printing machines, printing machines for use on sheet metal, 3D printers; maintenance, repair and installation of machines and control systems of embossing printing machines, flexographic printing machines, printing machines for use on sheet metal, 3D printers.

Class 42

(2) Chemical analysis and chemical research; design and development of computer hardware and software

Claims

Priority Filing Date: August 24, 2018, Country or Office: GERMANY, Application No: 3020181094090 in association with the same kind of goods and in association with the same kind of services

Application Number 1,923,203
Language of Application English

Filing Date 2018-10-02

APPLICANT AND AGENT DETAILS

Applicant

ToolPro, Inc.
1460-B Lockhart Drive
Kennesaw, GA 30144
UNITED STATES OF AMERICA

Agent

ROBIC
630, boul. René-Lévesque Ouest, 20e étage,
Montréal, QUEBEC, H3B1S6

TRADEMARK DETAILS

BAT KNIFE

Trademark Type

Standard Characters

Goods

Class 08

Coving knife; drywall coving knife; drywall corner knife; flexible drywall corner knife.

Claims

Priority Filing Date: May 30, 2018, Country or Office: UNITED STATES OF AMERICA, Application No: 87/941,708 in association with the same kind of goods

Application Number 1,923,207
Language of Application English

Filing Date 2018-10-02

APPLICANT AND AGENT DETAILS

Applicant

Victory Arts Incorporated
9 Harvey St
Ottawa
ONTARIO
K1S5S5

Agent

ANDREWS ROBICHAUD
1673 Carling Avenue, Suite 215, Ottawa,
ONTARIO, K2A1C4

TRADEMARK DETAILS

BAMBOO LOVE

Trademark Type

Word

Goods

Class 03

(1) Antiperspirants; aromatherapy oils; artificial fingernails; baby oil; baby wipes; bath gels; bath powder; beauty masks; blush; body creams, lotions, and powders; breath freshener; bubble bath; cosmetics; dentifrices; personal deodorants; dusting powder; essential oils for personal use; eye liner; face powder; facial creams; facial lotion; facial masks; facial scrubs; fragrance emitting wicks for room fragrance; fragrances for personal use; hair gel; hair conditioners; hair shampoo; hair mousse; hair creams; hair spray; hand cream; hand lotions; hand soaps; lip balm; lipstick; lipstick holders; lip gloss; liquid soaps; makeup; mascara; mouthwash; nail care preparations; nail glitter; nail hardeners; nail polish; perfume; potpourri; room fragrances; shaving cream; skin soap; talcum powders; skin creams; skin moisturizer; sun block; sun screen

Class 05

(2) disposable diapers for babies

Class 09

(3) Audio discs, audio recordings, audio and video recordings, musical recordings and video recordings in the form of pre-recorded compact discs, CD-ROMs, DVDs, digital versatile discs, digital video discs, optical discs and magneto-optical discs all featuring music, stories, games for children, live action entertainment for children and families, animated entertainment for children and families, motion picture films, and television shows; audio speakers; binoculars; calculators; camcorders; cameras; cellular telephones; cellular telephone accessories, namely, headphones, head sets, adapters and batteries for cellular telephones; cellular telephone cases; face plates for cellular telephones; compact disc players; compact disc recorders; computer games; computer game cartridges and discs; computer software, namely, computer games and educational software for children; cordless telephones; decorative magnets; digital cameras; DVD players; DVD recorders; electronic personal organizers; eyeglass cases; eyeglasses; graduated rulers for office and stationery; headphones; karaoke machines; microphones; MP3 players; mouse pads; motion

picture films; pagers; personal stereos; personal digital assistants; radios; sunglasses; telephones; television sets; video cameras; video game cartridges; video game discs; videophones; walkie-talkies; wrist and arm rests for use with computers

Class 14

(4) Alarm clocks; belt buckles of precious metal (for clothing); bolo ties with precious metal tips; bracelets; busts of precious metal; candle snuffers of precious metal; candlesticks of precious metal; jewelry charms; clocks; earrings; jewelry; jewelry cases of precious metal; jewelry chains; key rings of precious metal; lapel pins; letter openers of precious metal; neck chains; necklaces; necktie fasteners; non-monetary coins; ornamental pins; pendants; jewelry rings; slides for bolo ties; stop watches; tie clips; tie fasteners; tie tacks; wall clocks; watch bands; watch cases; watch chains; watch straps; watches; wedding bands; wristwatches

Class 16

(5) Address books; almanacs; appliques in the form of decals; appointment books; art prints; arts and craft paint kits; autograph books; baby books; baseball cards; binders; bookends; bookmarks; books; bumper stickers; calendars; cartoon strips; Christmas cards; chalk; chalk boards; children's activity books; coasters made of paper; coin albums; coloring books; coloring pages; comic books; comic strips; coupon books; decals; decorative paper centerpieces; diaries; drawing rulers; dry erase writing boards; envelopes; flash cards; gift cards; gift wrapping paper; globes; greeting cards; guest books; magazines; maps; modeling clay; newsletters; newspapers; paintings; paper flags; paper napkins; paperweights; paper gift wrap bows; paper pennants; paper place mats; paper table cloths; plastic table covers; plastic party bags; periodicals; photograph albums; photographs; pictorial prints; picture books; plastic materials for packaging in the nature of bags and film; portraits; postcards; posters; printed awards; printed certificates; printed invitations; printed menus; recipe books; rubber stamps; sandwich bags; score cards; stamp albums; staplers; stickers; trading cards; trays, namely, letter trays, paint trays; ungraduated rulers

Class 18

(6) All purpose sport bags; athletic bags; baby backpacks; backpacks; beach bags; book bags; calling card cases; change purses; coin purses; diaper bags; duffel bags; fanny packs; gym bags; handbags; knapsacks; key cases; leather key chains; lipstick holders; luggage; luggage tags; overnight bags; purses; satchels; shopping bags; tote bags; umbrellas; waist packs; wallets

Class 19

(7) engraved and cut stone plaques;

Class 20

(8) Air mattresses for use when camping; bassinets; beds; furniture benches; bird houses; bookcases; furniture cabinets; chairs; clips for holding and displaying photographs; coat racks; collapsible boxes of plastic for household use; computer keyboard trays; cots; couches; curtain rods; decorative glitter; decorative mobiles; desks; figurines and statuettes made of bone, plaster, plastic, wax, and wood; hand-held flagpoles, not of metal; foot stools; furniture, namely, bedroom furniture, computer furniture, dining room furniture, lawn furniture, patio furniture, office furniture, and living room furniture; gift package decorations made of plastic; hand fans; hand-held mirrors; jewelry boxes not of metal; key fobs not of metal; love seats; magazine racks; mattresses; mirrors; non-Christmas ornaments made of bone, plaster, plastic, wax and wood; ottomans; party ornaments of plastic; statue, trophy, and art pedestals; picture frames; pillows; plant stands made of wire and metal; decorative wall plaques; plastic flags; plastic name badges; plastic novelty license plates; plastic pennants; plastic cake decorations; sea shells; tables; toy chests; umbrella stands; venetian blinds; wind chimes

Class 21

(9) Barbecue mitts; beverage glassware; bowls; brooms; cake pans; cake molds; cake servers; candle holders not of precious metal; candle snuffers; canteens; ceramic figurines; drink coasters not of paper and not being table linen; cookie jars; cookie cutters; cork screws; cups; decorating bags for confectioners; decorative crystal prisms; decorative glass; decorative plates; dishes; drinking straws; figurines made of china, crystal, earthenware, glass, or porcelain; flower pots; hair brushes; hair combs; heat-insulated containers for food and beverages; insulating sleeve holders for beverage containers; lunch boxes; mugs; napkin holders; napkin rings not of precious metals; oven mitts; paper cups; paper plates; pie pans; pie servers; plastic cups; plastic water bottles; plates; pot holders; soap dishes; tea kettles; tea sets; thermal insulated containers for food or beverage; toothbrushes; trays, namely, ice cube molds, meal trays, and serving trays; trivets; vacuum bottles; waste baskets

Class 24

(10) Afghans bath linen; bath towels; bed blankets; bed canopies; bed linen; bed sheets; bed skirts; bed spreads; blanket throws; calico; children's blankets; cloth coasters; cloth doilies; cloth flags; cloth pennants; comforters; crib bumpers; curtains; fabric flags; felt pennants; golf towels; hand towels; handkerchiefs; hooded towels; linen for household purposes; kitchen towels; pillow cases; pillow covers; quilts; receiving blankets; silk blankets; sleeping bags; table linen; textile napkins; textile place mats; textile tablecloths; throws; towels of textile; washcloths; woolen blankets

Class 25

(11) Bandannas; baseball caps; beach cover-ups; beachwear; belts; baby bibs of plastic; bikinis; blazers; bow ties; bras; caps; chaps; cloth bibs; coats; dresses; ear muffs; footwear, namely, shoes, athletic shoes, slippers, boots and sandals; gloves; golf shirts; Halloween costumes; hats; head bands; head wear, namely, baseball caps, caps, caps with visors, stocking caps, toques, peak caps, hats, soft bucket hats, brimmed hats, golf hats and flop hat; hosiery; infantwear; jackets; jeans; jerseys; kerchiefs; leotards; leg warmers; mittens; neckties; night shirts; night gowns; overalls; pajamas; pants; panty hose; polo shirts; ponchos; rainwear; bath robes; beachrobes; scarves; shirts; skirts; shorts; slacks; slippers; sleepwear; socks; stockings; sweaters; sweat pants; sweat shirts; swimsuits; tank tops; tights; t-shirts; underwear; vests; wrist bands

Class 28

(12) Action skill games; action figures and accessories therefor; board games; card games; children's multiple activity toys; badminton sets; party balloons; baseball bats; basketballs; bath toys; baseballs; beach balls; bean bags; bean bag dolls; building blocks; bowling balls; bubble making wands and solution sets; catcher's mitts; chess sets; children's play cosmetics; Christmas stockings; Christmas tree decorations; collectable toy figures; crib mobiles; crib toys; disc toss toys; dolls; doll clothing; doll accessories; doll playsets; electric action toys; equipment sold as a unit for playing card games; fishing tackle; golf balls; golf gloves; golf ball markers; hand held unit for playing electronic games; hockey pucks; inflatable toys; jigsaw puzzles; jump ropes; kites; magic tricks; marbles; manipulative games, namely, action target games, arcade games, and manipulative puzzles; mechanical toys; music box toys; musical toys; parlor games; paper party favors; paper party hats; paper cake decorations; paper party decorations; paper party bags; party favors in the nature of small toys; party games; playing cards; plush toys; punching balls; puppets; return tops; roller skates; rubber balls; skateboards; snowboards; snow globes; soccer balls; spinning tops; squeeze toys; stuffed toys; table tennis tables; target games; teddy bears; tennis

balls; toy action figures; toy bucket and shovel sets; toy mobiles; toy vehicles; toy scooters; toy cars; toy model kits; toy figures; toy banks; toy trucks; toy watches; water squirting toys; wind-up toys

Class 29

(13) Cheese; cheese spread; candied fruit; chocolate milk; dairy products excluding ice cream, ice milk and frozen yogurt; snack food dips; dried fruits; drinking yogurts; frozen meals consisting primarily of meat, fish, poultry or vegetables; fruit preserves; fruit-based snack food; jams; jellies for food; milk beverages with high milk content; meats; mixes for making milk shakes; nuts; peanut butter; potato chips; potato-based snack foods; powdered milk; raisins; snack mix consisting primarily of processed fruits, processed nuts and raisins; soup; soup mixes; sweetened gelatin desserts; yogurt

Class 30

(14) Bagels; biscuits; bread; breakfast cereal; cereal based snack food; bubble gum; cakes; cake mixes; candies; cake decorations made of candy; ketchup; cereal-based snack bars; chewing gum; chocolate; chocolate-based beverages; cocoa-based beverages; cones for ice cream; candy; cookies; corn-based snack foods; crackers; deli sandwiches; flavored, sweetened gelatin desserts; frozen confections; frozen meals consisting primarily of pasta or rice; frozen yogurt; honey; ice cream; ice milk; licorice; marshmallows; mayonnaise; muffins; mustard; noodles; oatmeal; pancakes; pancake mixes; pasta; pastries; pancake syrup; pies; pizza; popcorn; pretzels; puddings; rice; bread rolls; salad dressings; sauces, namely, apple sauce, cheese sauce, chocolate sauce, fish sauce, fruit sauce, gravy sauce, hot sauce, meat sauce, pasta sauce, pepper sauce, soy sauce, spaghetti sauce, tartar sauce, and tomato sauce; sherbets; spices; tea; tortillas; waffles

Class 32

(15) Drinking water; energy drinks; flavored waters; fruit juices; fruit-flavored beverages; fruit juice concentrates; lemonade; fruit punch; non-alcoholic beverages, namely, carbonated beverages; non-alcoholic beverages containing fruit juices; smoothies; sparkling water; sports drinks; syrups for making soft drinks; table water; vegetable juices

Services

Class 41

Production, presentation, distribution, and rental of motion picture films; production, presentation, distribution, and rental of television and radio programs; production, presentation, distribution, and rental of sound and video recordings; production of entertainment shows, entertainment information shows and interactive programs, namely, movies, television shows, music and computer games for distribution via television, cable, satellite, laser discs, computer discs and the internet; production and distribution of comedic, dramatic and musical entertainment, news, and information in the field of movies, television shows, music and computer games via communication and computer networks, namely, the Internet; amusement park and theme park services; live stage shows, namely, comedic, dramatic and musical performances; presentation of live performances, namely, comedic, dramatic and musical performances; theater productions; entertainer services, namely, live appearances by a professional comedic, dramatic and musical entertainers

Application Number 1,924,412
Language of Application English

Filing Date 2018-10-10

APPLICANT AND AGENT DETAILS

Applicant

Acquire Industries Ltd.
68 Munro Blvd.
Toronto
ONTARIO
M2P1C2

Agent

ROWAND LLP
3080 Yonge Street, Suite 6060, Toronto,
ONTARIO, M4N3N1

TRADEMARK DETAILS

POWER ROLL

Trademark Type

Word

Goods

Class 02

(1) Coatings in the nature of electrically conductive inks for use in the manufacture of printed circuits

Class 07

(2) Generators of electricity; road rollers; road building machines, namely, pavement spreaders, pavers, profilers and finishing machines, graders, rollers, compactors, bulldozers, scrapers, loaders, tracked and wheeled tractors equipped with attachments, namely, mowers, augers, drills, compactors, spraying equipment, snow blowers, snow plows, buckets, and shovels, rock trucks, off-road mobile cranes, off-road excavators, and low-speed street sweepers

Class 08

(3) Hand held cutting tools; punch pliers; hand tool punches; crimping tools

Class 09

(4) Electric cables; electric wires; electrical extension cords; insulated copper wire; electrical conductors, namely, electric heaters printed using conductive inks onto flexible films; capacitors; electric accumulators for vehicles; general purpose batteries; solar batteries; photovoltaic cells; piezoelectric cells; thermoelectric cells; precision measuring apparatuses, namely, calipers, micrometers, depth gauges, thickness gauges, and level gauges; printed circuits; sheaths for electric cables; sheaths for electric appliances; clothing, headwear, face-shields, footwear and gloves for protection against accidents; ground-fault protection devices; circuit breakers; electrically controlled contactors; electric relays; electric limiters; distribution boards; distribution consoles; electrical switch panels; electric transformers; electric power converters; DC/AC inverters; distribution boxes; branch boxes; junction boxes; covers for electric outlets; battery boxes; electric battery chargers for use with planar power distribution cables; electric battery chargers for use with planar generation apparatuses; electric batteries, planar; automotive batteries; capacitors; electrical adapters, namely, for use with planar electric distribution cables; heat regulators; electric current switches; electric plugs; current rectifiers; electric ducts; cathodes; electric cables; insulated copper wire; electrical conductors, namely, for assembly of planar power

distribution systems; electrical conductors, namely, for assembly of planar generation apparatuses; terminals for interfacing with conductors; electricity conduits connectors; connections for electric lines couplings; electrical connectors; mechanical wire connectors; junction sleeves for electric cables; electric sockets identification threads for electric wires; identification sheaths for electric wires; electric installations for remote control of power generation, distribution and storage operations, namely, in-line conductors and over-air radio receivers and transceivers; control panels for measurement, temperature and power regulation, protection, and metering; meters for monitoring electrical consumption; climate control digital thermostats; electric monitoring apparatus, namely, voltage and current monitoring units, energy meters for tracking and monitoring energy usage; measuring devices, namely, electromagnetic measuring detectors, meters for measuring electric current; electric ohmmeters; ammeters; thermostats; digital thermometers, not for medical purposes; temperature indicators; temperature indicator labels, not for medical purposes; rheostats; hydrometers; water level indicators; piezoelectric sensors; time switches; electronic weighing scales for personal use; photovoltaic cells; fluorescent screens; flashing safety lights; luminous or mechanical signals; organic light-emitting diodes [OLED]; quantum dot light-emitting diodes [QLED]; apparatus light-emitting diodes [LED]; GPS receivers; GPS transmitters; radio signal antennas; theft alarms; anti-theft alarms, other than for vehicles; filters for radio interference suppression; solenoid valves [electromagnetic switches]; integrated circuits; integrated chips; integrated circuit cards; computer operating programs; computer monitors; computer display screens; video screens; computer programs for controlling human input/output interfaces, namely, electronic display interfaces and control panels; electronic tags for goods; fire blankets; traffic cones; printers for use with computers.

Class 17

(5) Foils of metal for insulating; plastic films for electrical insulation; polymer films for use in manufacture; semi-processed plastic substances; paper for electrical capacitors; adhesive tapes for assembly of electric power distribution apparatuses; adhesive tapes for assembly of electric power generation apparatuses; selfadhesive tapes for sealing, mounting, and assembly of power generation, distribution, storage, sensing, heating, and lighting apparatuses, namely solar panels, power cables, batteries, temperature sensors, heaters, and lights; electrical insulation; insulating refractory materials; insulators for electric mains; fiberglass for insulation; fiberglass fabrics for insulation; soldering threads of plastic; insulating tapes; insulating paper; insulating felt; insulating plaster; insulating fabrics; insulating varnish; insulating paints; carbon fibers; mica; non-metal pipe jackets; insulating waterproof membranes; padding materials of rubber or plastics; rubber solutions; weatherstripping compositions; metal gaskets; synthetic rubber; shockabsorbing buffers of rubber; latex rubber; liquid rubber; caulking materials; expansion joint fillers; vulcanized fiber; rubber thread and covered rubber yarn; carbon fibers; sealant compounds for joints; semi-processed synthetic resins; semi-processed plastic substances; semi-processed acrylic resins; plastic filaments for 3D printing.

Class 19

(6) Fireproof cement coatings, binding material for road repair, road marking sheets and strips of synthetic material, gypsum.

Services

Class 37

(1) Construction and repair of buildings; building construction supervision; services of electricians; installation of utilities in construction sites; rental of construction equipment; assembly services relating to the installation of machines, machine tools and automatic systems for treating and processing metals.

Class 40

(2) Screen printing; flexographic printing; offset printing; silkscreen printing; inkjet printing, laminating; custom manufacturing of mouldings of concrete and metal; rental of electricity generators; window tinting treatment; surface coating, namely, coating and surface treatments for assembly of electric planar apparatuses; surface coating, namely, coating and surface treatments for assembly of electric planar solar photo-voltaic, wire, capacitor, heating, and lighting elements electroplating; silver plating; cadmium plating; chromium plating; tin plating; nickel plating; gold plating; metal casting; laser scribing of plastic, metals and ceramics; sandblasting services, galvanization, magnetization, welding services, soldering, custom 3D printing for others.

Class 41

(3) Publishing of books, magazines, reviews, textbooks, instruction manuals, and technical documentation; providing training in the fields of building and construction materials.

Class 42

(4) Industrial design; engineering in the field of materials science; construction drafting; scientific research in the field of materials science; technological research in the field of materials science; product design consulting services; construction project engineering; research and development for new products for others; research in the field of building construction; providing quality assurance in the construction industry; calibration of electronic equipment; material testing; textile testing; laboratory research in the field of chemistry; chemical research; chemical analysis; laboratory testing of materials; scientific and technological research relating to patent mapping; consultancy in the field of energy-saving; research in the field of environmental protection; urban planning; advice and consultancy in relation to carbon offsetting; energy auditing; research in the field of telecommunications technology; consultancy in the design and development of computer hardware; computer programming; computer software design; installation of computer software; rental of computer software; maintenance of computer software; updating of computer software; monitoring of computer systems by remote access; off-site data backup; cloud computing provider services for general storage of data; hosting web sites; server hosting; creating and designing website-based indexes of information for others; packaging design; graphic design of promotional materials.

Application Number 1,925,158
Language of Application English

Filing Date 2018-10-15

APPLICANT AND AGENT DETAILS

Applicant

Meopta - optika, s.r.o.
2682/1 Kabelikova
Prerov CZ75002
CZECH REPUBLIC

Agent

CHOOI LAW PROFESSIONAL
CORPORATION
738 Spadina Avenue, Suite 200, Toronto,
ONTARIO, M5S2J8

TRADEMARK DETAILS

DICHROTECH

Trademark Type

Word

Goods

Class 09

Telescopes and periscopes; riflescopes; optical lenses; optical filters; prisms for optic purposes; binoculars; spotting scopes; collimators; stereo projectors; 3D holographic projectors; analysis instruments for photogrammetric purposes; astronomical spectrographs; bags specially adapted for cameras and photographic equipment; biomicroscopes; borescopes; cables for electrical and optical signal transmission; cables for optical signal transmission; cases adapted for photographic equipment; cinematographic projectors; colour filters for television and cinematographic cameras; colour filters for television and motion picture film cameras; computer programs and software for image processing; computer screen filters; computer software for optical character recognition; computer software for organizing and viewing digital images and photographs; computer software for scanning; digitizing, altering and retouching of photographs; convex security mirrors; digital photo-optical systems; drainers for use in photography; drying racks for photography; earth satellites for use in earth observation; electrical cables for projectors; electron microscopes; epidiascope; equatorial telescopes, exposure meters for photographic devices; fibre optic light and image conduits; fibre optic periscopes; fibre-optic borescopes; flash lamps for photography; fluorescence microscopes; frames for photographic transparencies; gyroscopes; home cinema projectors; iconoscopes; image intensifier tubes; inspection mirrors; intensifying screens for X-ray films; lcd projectors; LED Microscopes; lens barrels for microscopes; lens barrels for telescopes; lens filters for cameras; lens-barrels; lenses for astrophotography; lenses for binoculars; lenses for cameras; lenses for microscopes; lenses for monoculars; lenses for telescopes; lenses for video cameras; macro lenses for cameras; magnifying lenses; meridian transit telescopes; micrometer screws for optical instruments; microscope illuminating devices; microscope lamps; microscope lenses; microscope slides; microscope slides for laboratory use; microscopes; microscopes and parts thereof; microscopes for medical use; microscopes for operations; mirrorless cameras; motion picture projectors; movie editing projectors; movie projectors; multimedia projectors; near-eye display optics; observation rockets; opaque projectors; optical amplifiers; optical apparatus for guiding projectiles; optical apparatus in the form of stereo microscopes; optical condensers; optical disc drives; optical disc readers; optical filters; optical filters for plasma display panels; optical filters for screens; optical frames; optical frequency metrology devices; optical glass; Optical lens blanks; optical lens sights; optical lenses; optical microscopes for biological purposes; optical

microscopes for industrial purposes; optical microscopes for materials testing; optical microscopes for scientific purposes; optical multiplexers; optical phase shifters; optical position sensors; optical power meters; optical profilers; optical receivers; optical reflectors; optical scanners; optical semiconductor amplifiers; optical sensors; optical shutters; optical switches; optical transceivers; optical transmitters; optical waveguides; oscilloscope tubes; oscilloscopes; overhead projectors; periscopes; photographic cameras; photographic cameras for the instant production of pictures; photographic digital cameras; photographic exposure meters; photographic filters; photographic flash units for cameras; photographic flashbulbs; photographic lenses; photographic lenses for use in aerial photography; photographic negatives; photographic projectors; photographic racks; photographic slide transparencies; photographic viewfinders; photography darkroom lamps; photography projectors; photography reflectors; planetarium projectors; polarimeters; polarization-maintaining optical fibers; polarizing filters for digital cameras; polarizing microscopes; polarizing spectacles; prisms for microscopes; prisms for telescopes; profile projectors; projected capacitive touch sensors; projection keyboards; projection screens; projection screens for cinematographic films; projection screens for movie films; projectors for home theatre systems; projectors for the entertainment industry; receiving antennas for satellite broadcast; reflectors for microscopes; reflectors for photography; reflectors for telescopes; remote controls for projectors; satellite aerials; satellite antennas; satellite dishes; satellite dishes for satellite transmissions; satellite finder meters; satellite navigation devices; satellite navigation systems; satellite processors; satellite receivers; satellite transceivers; satellite transmitters; satellites; satellites for scientific purposes; self-acting focusing projectors; shutter releases for photography; shutters for photography; sighting telescopes for firearms; software for satellite navigation systems; spectrograph apparatus; spectrophotometers; spectrophotometers for laboratory use; spectroscopes; spectroscopes for laboratory use; spectrum analyzers; spools for photography; spotting scopes; stereomicroscopes; stereoscopes; stroboscopes; surgical microscopes; telephoto lenses for cameras; telescopes; telescopic inspection mirrors for automotive use; telescopic lens sights; telescopic riflescopes; toolmakers' microscopes; transistor outline package with integrated lens; transmission electron microscopes; transparencies for use in photography; tripods for telescopes; turntables being parts of microscopes; ultrashort pulse lasers for spectroscopy; video processors for microscopes; washing trays for photography; wide angle lenses for cameras; zenith telescopes; zoom lenses for cameras; zoom microscopes.

Application Number 1,925,320
Language of Application English

Filing Date 2018-10-15

APPLICANT AND AGENT DETAILS

Applicant

Unispace Global Pty Ltd
43/225 George Street
Sydney NSW 2000
AUSTRALIA

Agent

MILLER THOMSON LLP
SCOTIA PLAZA, 40 KING STREET WEST,
SUITE 5800, P.O. BOX 1011, TORONTO,
ONTARIO, M5H3S1

TRADEMARK DETAILS

UNISPACE

Trademark Type

Word

Services

Class 35

(1) Business organisation consulting; business management organisation consultancy; business logistics services, namely, business management and organization services in the field of business facilities and resources; business project management services for construction projects; management of business offices for others; business risk assessment services, namely, evaluations in the field of organisation practices for business management purposes; business project management services for interior design projects;

(2) business appraisals and evaluations in business matters; business management consultancy as well as development of processes for the analysis and the implementation of strategy plans and management projects; business management consulting with relation to strategy, marketing, production, personnel and retail sale matters; business strategic planning services; business strategy development services; conducting business and market research surveys for others; conducting public opinion surveys; consultancy and advisory services in the field of business strategy; consultancy and advisory services in the field of business strategy; design of marketing surveys; design of public opinion surveys; profit survey and analysis services; statistical evaluation of data from market studies; statistical evaluation of market research data; statistical evaluations of marketing data;

Class 36

(3) Real estate investment management; real estate investment services; real estate management; providing information in the field of real estate

Class 37

(4) renovation and restoration of building services, namely, renovations, conversions and refurbishments of office and commercial buildings; construction project management services; general building contractor services; general construction contracting; office renovations, conversions, refurbishment; interior retrofitting of buildings; interior refurbishment of buildings

(5) building construction services; consultation in building construction supervision;

Class 42

(6) Architectural design services; interior design services; interior decoration of offices; architectural project management; real estate planning, namely construction planning, planning and design of residential communities, and planning and design of commercial buildings;

(7) construction planning; design of interior decor; engineering surveying services; interior decorating;

Claims

Priority Filing Date: May 11, 2018, Country or Office: AUSTRALIA, Application No: 01926188 in association with the same kind of services

Application Number 1,925,321
Language of Application English

Filing Date 2018-10-15

APPLICANT AND AGENT DETAILS

Applicant

Unispace Global Pty Ltd
43/225 George Street
Sydney NSW 2000
AUSTRALIA

Agent

MILLER THOMSON LLP
SCOTIA PLAZA, 40 KING STREET WEST,
SUITE 5800, P.O. BOX 1011, TORONTO,
ONTARIO, M5H3S1

TRADEMARK DETAILS

Trademark Type

Design

Visual Representation



Services

Class 35

(1) Business organisation consulting; business management organisation consultancy; business logistics services, namely, business management and organization services in the field of business facilities and resources; business project management services for construction projects; management of business offices for others; business risk assessment services, namely, evaluations in the field of organisation practices for business management purposes; business project management services for interior design projects;

(2) business appraisals and evaluations in business matters; business management consultancy as well as development of processes for the analysis and the implementation of strategy plans and management projects; business management consulting with relation to strategy, marketing, production, personnel and retail sale matters; business strategic planning services; business strategy development services; conducting business and market research surveys for others; conducting public opinion surveys; consultancy and advisory services in the field of business strategy; consultancy and advisory services in the field of business strategy; design of marketing surveys; design of public opinion surveys; profit survey and analysis services; statistical evaluation of data from market studies; statistical evaluation of market research data; statistical evaluations of marketing data;

Class 36

(3) Real estate investment management; real estate investment services; real estate management; providing information in the field of real estate

Class 37

(4) renovation and restoration of building services, namely, renovations, conversions and refurbishments of office and commercial buildings; construction project management services; general building contractor services; general construction contracting; office renovations, conversions, refurbishments; interior retrofitting of buildings; interior refurbishment of buildings

(5) building construction services; consultation in building construction supervision;

Class 42

(6) Architectural design services; interior design services; interior decoration of offices; architectural project management; real estate planning, namely construction planning, planning and design of residential communities, and planning and design of commercial buildings;

(7) construction planning; design of interior decor; engineering surveying services; interior decorating;

Claims

Priority Filing Date: May 11, 2018, Country or Office: AUSTRALIA, Application No: 01926209 in association with the same kind of services

Application Number 1,925,601
Language of Application English

Filing Date 2018-10-17

APPLICANT AND AGENT DETAILS

Applicant

LORD Corporation
111 Lord Drive
Cary, NC 27511
UNITED STATES OF AMERICA

Agent

PERLEY-ROBERTSON, HILL & MCDUGALL
LLP
1400 - 340 ALBERT STREET, OTTAWA,
ONTARIO, K1R0A5

TRADEMARK DETAILS

COOLTHERM

Trademark Type

Word

Goods

Class 01

Industrial adhesives for automotive, transportation, electronics, and industrial equipment industries; industrial adhesives for use in coating and sealing in the automotive, transportation, electronics, and industrial equipment industries; adhesives for thermal management applications in the automotive, transportation, electronics, and industrial equipment industries; adhesives for heat transfer in electronic components in the automotive, transportation, electronics, and industrial equipment industries; polymer compositions, namely thermally conductive potting compounds, gap fillers, coatings, adhesives, and encapsulants, all for automotive, transportation, electronics, and industrial equipment industries

Application Number 1,925,820
Language of Application English

Filing Date 2018-10-18

APPLICANT AND AGENT DETAILS

Applicant

Loblaws Inc.
1 President's Choice Circle
Brampton
ONTARIO
L6Y5S5

Agent

BORDEN LADNER GERVAIS LLP
World Exchange Plaza, 100 Queen Street,
Suite 1300, Ottawa, ONTARIO, K1P1J9

TRADEMARK DETAILS

Trademark Type

Design

Visual Representation



Services

Class 35

- (1) Online retail grocery store services; advertising the goods and services of others, namely, advertising and promoting customer appreciation and community events of others; retail grocery store services
- (2) Advertising the goods and services of others, namely, advertising and promoting food drives and charitable events of others
- (3) Conducting social media campaigns through the creation of a hashtag for the purpose of promoting public awareness of the benefits of sharing mealtimes with others;

Class 42

- (4) Creating an online community by the use of a hashtag for users to participate in discussions and engage in social networking for the purposes of raising awareness of the benefits of sharing mealtimes with others;

Application Number 1,926,044
Language of Application English

Filing Date 2018-10-18

APPLICANT AND AGENT DETAILS

Applicant

HEWMAC INDUSTRIES LTD.
5151 45th Avenue
Delta
BRITISH COLUMBIA
V4K1K6

Agent

OYEN WIGGS GREEN & MUTALA LLP
480-THE STATION, 601 WEST CORDOVA
STREET, VANCOUVER, BRITISH
COLUMBIA, V6B1G1

TRADEMARK DETAILS

HEWMAC INDUSTRIES LTD.

Trademark Type

Word

Goods

Class 09

rebar covers to protect workers from impalement or other injury, impalement prevention apparatuses for extending overtop of and around the exposed ends of rebar, covers for vertical and horizontal rebar protection, covers on exposed rebar at construction sites for fall and abrasion protection, and parts for the aforementioned goods

Services

Class 35

(1) wholesale sales of concrete forming products, in particular rebar covers and parts thereof; retail sale of concrete forming products, in particular rebar covers and parts thereof; and online sales of concrete forming products, in particular rebar covers and parts thereof

Class 37

(2) rental of concrete forming products, in particular rebar covers and parts thereof; vertical and horizontal rebar protection consulting services; fall and abrasion protection consulting services; and installation of covers on exposed rebar at construction sites

Application Number 1,926,045
Language of Application English

Filing Date 2018-10-18

APPLICANT AND AGENT DETAILS

Applicant

HEWMAC INDUSTRIES LTD.
5151 45th Avenue
Delta
BRITISH COLUMBIA
V4K1K6

Agent

OYEN WIGGS GREEN & MUTALA LLP
480-THE STATION, 601 WEST CORDOVA
STREET, VANCOUVER, BRITISH
COLUMBIA, V6B1G1

TRADEMARK DETAILS

HEWMAC

Trademark Type

Word

Goods

Class 09

rebar covers to protect workers from impalement or other injury, impalement prevention apparatuses for extending overtop of and around the exposed ends of rebar, covers for vertical and horizontal rebar protection, covers on exposed rebar at construction sites for fall and abrasion protection, and parts for the aforementioned goods

Services

Class 35

(1) wholesale sales of concrete forming products, in particular rebar covers and parts thereof; retail sale of concrete forming products, in particular rebar covers and parts thereof; and online sales of concrete forming products, in particular rebar covers and parts thereof

Class 37

(2) rental of concrete forming products, in particular rebar covers and parts thereof; vertical and horizontal rebar protection consulting services; fall and abrasion protection consulting services; and installation of covers on exposed rebar at construction sites

Application Number 1,926,461
Language of Application English

Filing Date 2018-10-22

APPLICANT AND AGENT DETAILS

Applicant

Gant Financial Inc.
515 Park Road North
Brantford
ONTARIO
N3R7K8

Agent

MARCEL D. MONGEON
3-35 Stone Church Road, Suite 374, Ancaster,
ONTARIO, L9K1S5

TRADEMARK DETAILS

WHAT'S YOUR BEACON?

Trademark Type

Word

Disclaimer

The right to the exclusive use of the word BEACON is disclaimed apart from the trademark.

Goods

Class 16

(1) Educational materials in the area of financial literacy, namely books, and workbooks

Class 25

(2) Promotional clothing, namely t-shirts and hats

Services

Class 36

(1) financial analysis consultation services

Class 41

(2) educational services in the field of financial planning

Application Number 1,926,837
Language of Application English

Filing Date 2018-10-24

APPLICANT AND AGENT DETAILS

Applicant

CNH INDUSTRIAL N.V.
25 St. James's Street
London SW1A 1HA
UNITED KINGDOM

Agent

GOWLING WLG (CANADA) LLP
SUITE 2600, 160 ELGIN STREET, OTTAWA,
ONTARIO, K1P1C3

TRADEMARK DETAILS

Trademark Type

Design

Visual Representation



Colour Claim

Colour is claimed as a feature of the trade-mark. The colours grey, black, gold and white are claimed. The broken leaf design is grey. The swoosh that runs from the bottom of the leaf and under the words NEW HOLLAND consists of dark and light shades of gold. The words NEW HOLLAND are white outlined in black.

Goods

Class 07

(1) Agricultural and earth working machinery and implements therefor, namely agricultural harvesting machines, agricultural baling machines, combine harvesters, bale stacking wagons, combine headers, forage harvesters, forage blowers, feed grinders and mixers, mowers, namely, lawn and garden tractors, mower-conditioners, side delivery rakes, rotary rakes and tedders, windrowers, windrow inverters, manure spreaders, bale movers and carriers, tractor loaders, tillage and seeding equipment, sprayers and parts and fittings for all the aforesaid goods; Material handling equipment, namely grapples, forks, lifts, booms, backhoe buckets, telescopic handlers and parts and fittings for all the aforesaid goods

Class 12

(2) Agricultural and industrial tractors and parts and fittings for all the aforesaid goods

Application Number 1,926,838
Language of Application English

Filing Date 2018-10-24

APPLICANT AND AGENT DETAILS

Applicant

CNH INDUSTRIAL N.V.
25 St. James's Street
London SW1A 1HA
UNITED KINGDOM

Agent

GOWLING WLG (CANADA) LLP
SUITE 2600, 160 ELGIN STREET, OTTAWA,
ONTARIO, K1P1C3

TRADEMARK DETAILS

Trademark Type

Design

Visual Representation

NEW HOLLAND

Goods

Class 07

(1) Agricultural and earth working machinery and implements therefor, namely agricultural harvesting machines, agricultural baling machines, combine harvesters, bale stacking wagons, combine headers, forage harvesters, forage blowers, feed grinders and mixers, mowers, namely, lawn and garden tractors, mower-conditioners, side delivery rakes, rotary rakes and tedders, windrowers, windrow inverters, manure spreaders, bale movers and carriers, tractor loaders, tillage and seeding equipment, sprayers and parts and fittings for all the aforesaid goods; Material handling equipment, namely grapples, forks, lifts, booms, backhoe buckets, telescopic handlers and parts and fittings for all the aforesaid goods; Construction equipment and earth moving machines, namely logging, land-shaping and land-clearing machines, namely, loaders, skid steer loaders, loader backhoes, bulldozers, excavators, scrapers, motor graders, crawler dozers, and parts and fittings for the aforesaid goods

Class 12

(2) Agricultural and industrial tractors and parts and fittings for all the aforesaid goods

Application Number 1,927,534
Language of Application English

Filing Date 2018-10-26

APPLICANT AND AGENT DETAILS

Applicant

RIEDHAMMER GmbH
Klingenhofstr. 72
90411 Nürnberg
GERMANY

Agent

KIRBY EADES GALE BAKER
100 Murray Street, Suite 500, Ottawa,
ONTARIO, K1N0A1

TRADEMARK DETAILS

RIEDHAMMER

Trademark Type

Word

Goods

Class 07

(1) motors for aeration machines for industrial furnaces; drive chains for conveyors for moving goods through in industrial furnaces; transmission shafts for machines for moving goods through in industrial furnaces; machine parts, namely bearings, hydraulic intensifiers, hydraulic accumulators, reduction gears, speed change gears; machine parts, namely pumps and compressors, fans and fan belts for motors and engines; automatic door and window openers; hydraulic door and window openers, pneumatic door and window openers; electric, hydraulic and pneumatic hoists, wire hoists, hydraulic lift tables, cables for lifts; conveyors and conveyor belts; direct current motors, alternating current servo motors, electric motors for machines, winch motors, power tool motors; generators for industrial machinery, catalytic converters for motors and engines, connecting rods for machines, motors and engines, cooling radiators for machines, motors and engines, cylinders for motors and engines; thermostatic control valves for machines; fuel dispensing pumps for service stations; flues for engine boilers; safety valves; ceramic rollers for roller hearth furnaces; parts and fittings of motors for aeration machines for industrial furnaces, drive chains for machines for moving goods through in industrial furnaces, transmission shafts for machines for moving goods through in industrial furnaces, machine parts, namely bearings, hydraulic intensifiers, hydraulic accumulators, reduction gears, speed change gears; machine parts, namely pumps and compressors, fans and fan belts for motors and engines, automatic door and window openers, hydraulic door and window openers, pneumatic door and window openers, electric, hydraulic and pneumatic hoists, wire hoists, hydraulic lift tables, cables for lifts, conveyors and conveyor belts, direct current motors, alternating current servo motors, electric motors for machines, winch motors, power tool motors, generators for industrial machinery, catalytic converters for motors and engines, connecting rods for machines, motors and engines, cooling radiators for machines, motors and engines, cylinders for motors and engines, thermostatic control valves for machines, and fuel dispensing pumps for service stations, flues for engine boilers, safety valves, and ceramic rollers for roller hearth furnaces

Class 11

(2) Industrial furnaces, furnace boilers, heating furnace burners for industrial purposes, gas burners, automatic air dryers for use in cooling industrial furnaces, industrial refrigerators, cooling

evaporators, cooling vats, and electric fans with evaporative cooling devices for use with industrial furnaces, coolers for industrial furnaces; industrial treatment installations, namely, gas filters for engines and motors, gas purification machines, gas scrubbers; kilns, blast furnaces, gas generating furnaces for industrial purposes; flues for heating boilers, exhaust fans for industrial furnaces; gas burners, oil burners, oven burners, oxyhydrogen burners, petrol burners, electric boilers, furnace boilers, heating boilers, water heaters, gas water heaters, immersion heaters, heaters for vehicles; fireplaces; air filtering units for removing dust, smoke and allergens from the air for industrial use, water filtering units for industrial use; drying ovens; safety lamps, for gas installations; parts and fittings of industrial furnaces, furnace boilers, heating furnace burners for industrial purposes, gas burners, automatic air dryers for use in cooling industrial furnaces, industrial refrigerators, cooling evaporators, cooling vats, and electric fans with evaporative cooling devices for use with industrial furnaces, coolers for industrial furnaces, industrial treatment installations, namely, gas filters for engines and motors, gas purification machines, gas scrubbers, kilns, blast furnaces, gas generating furnaces for industrial purposes, flues for heating boilers, exhaust fans for industrial furnaces, gas burners, oil burners, oven burners, oxyhydrogen burners, petrol burners, electric boilers, furnace boilers, heating boilers, water heaters, gas water heaters, immersion heaters, heaters for vehicles, fireplaces, air filtering units for removing dust, smoke and allergens from the air for industrial use, water filtering units for industrial use, drying ovens, safety lamps, for gas installations

Class 19

(3) non-metal refractory furnace linings, non-metal linings for industrial furnaces, and parts and fittings thereof; refractory ceramic parts, namely kiln fittings for industrial furnaces; non-metal building materials and elements, construction materials and elements, refractory building materials and elements, namely, refractory bricks, refractory castable mixes, refractory concrete, refractory mortars, cement for blast furnaces, cement for furnaces, ceramic water pipe valves, cement blocks, cement chimneys, cement mixes, cement mortar pipes, cement partitions for buildings, cement sewer pipes, cement slabs, fireproof cement coatings, and joining cement; ceramic monuments for use in industrial furnaces; ceramic drain pipes, clay pipes and conduits, concrete pipes, fiberglass drainage pipes, non-metal drain pipes, plastic branching pipes, plastic storm sewer pipes for constructions, plastic water pipes, PVC conduit pipes of building, PVC rigid pipes for construction purposes, PVC sewer pipes, PVC water pipes, sandstone pipes; parts and fittings of refractory ceramic parts, namely kiln fittings for industrial furnaces, non-metal building materials and elements, construction materials and elements, refractory building materials and elements, namely, refractory bricks, refractory castable mixes, refractory concrete, refractory mortars, cement for blast furnaces, cement for furnaces, ceramic water pipe valves, cement blocks, cement chimneys, cement mixes, cement mortar pipes, cement partitions for buildings, cement sewer pipes, cement slabs, fireproof cement coatings, and joining cement, ceramic monuments for use in industrial furnaces, ceramic drain pipes, clay pipes and conduits, concrete pipes, fiberglass drainage pipes, non-metal drain pipes, plastic branching pipes, plastic storm sewer pipes for constructions, plastic water pipes, PVC conduit pipes of building, PVC rigid pipes for construction purposes, PVC sewer pipes, PVC water pipes, and sandstone pipes

Services

Class 37

(1) advisory services relating to the construction of buildings; building construction; building construction and repair; building construction contracting services; building construction services; building construction supervision; building demolition; building disinfecting; building inspection; building insulating; building maintenance and repair; building of shops; building reinforcing;

building restoration; cleaning of building exterior surfaces; cleaning of buildings; construction and renovation of buildings; construction and repair of buildings; consultation in building construction supervision; information concerning rental of equipment for building construction; installation of building insulation; maintenance and repair of buildings; refurbishment of buildings; repair and maintenance of buildings in case of demolition; repair of buildings; repair work on buildings; burner maintenance and repair; furniture maintenance; electrical repair and installation of air conditioners; electrical repair and installation of electrical motors; electrical repair and installation of heaters; electrical repair and installation of lighting; fire alarm installation and repair; furnace installation and repair; heating equipment installation and repair; installation and repair of air conditioners; installation of electrical and generating machinery; construction, installation, building, maintenance and repair of machines and plants, especially of machines and plants for the production of refractory products, anodes, cathodes and electrodes as well as of ceramic products, particularly of ceramic products in the form of technical ceramics, sanitaryware, tableware, and ceramic parts and fittings for industrial furnaces; construction, installation, building, maintenance and repair of machines and plants, especially of furnaces, particularly of furnaces for the production of refractory products, anodes, cathodes and electrodes as well as of ceramic products, particularly of ceramic products in the form of technical ceramics, sanitaryware, tableware, and ceramic parts and fittings for industrial furnaces

Class 42

(2) Planning of buildings and infrastructure systems for buildings; research in the field of building construction; research on building construction; residential and commercial building design service; biochemical research; chemical research; physics research; pollution prevention research; research and development of new products for others; research in the field of environmental protection; research pertaining to mechanical engineering; providing technology information in the oil and gas industry; industrial design; product design consulting services; tool design; design and development of machines and plants, especially of machines and plants for the production of refractory products, anodes, cathodes and electrodes as well as of ceramic products, particularly of ceramic products in the form of technical ceramics, sanitaryware, tableware, and ceramic parts and fittings for industrial furnaces; design and development of machines and plants, especially of furnaces, particularly of furnaces for the production of refractory products, anodes, cathodes and electrodes as well as of ceramic products, particularly of ceramic products in the form of technical ceramics, sanitaryware, tableware and ceramic parts and fittings for industrial furnaces; research, development, and design in the field of industrial furnaces and parts and fittings for industrial furnaces; engineering services in the field of industrial furnaces and parts and fittings for industrial furnaces

Application Number 1,927,688
Language of Application English

Filing Date 2018-10-29

APPLICANT AND AGENT DETAILS

Applicant

BENECKE-KALIKO AG
Beneckeallee 40
30419
Hannover
GERMANY

Agent

ROBIC
630, boul. René-Lévesque Ouest, 20e étage,
Montréal, QUEBEC, H3B1S6

TRADEMARK DETAILS

ACELLA

Trademark Type

Word

Goods

Class 12

(1) Vehicles, namely all-terrain vehicles, sport utility vehicles, trucks, motor cars, electric cars, two-wheeled motor vehicles, namely motor scooters, electric scooters, motorcycles; apparatus for locomotion by land, air or water, namely airplanes, boats, trains; surface material for lining vehicle interiors, namely clutch linings for land vehicles, interior trim parts of automobiles; vehicle interior linings, namely interior trim for automobile; interior panels for vehicles; seat covers for vehicles; seat covers (shaped) for use in automobiles; automobile running boards of rubber; fitted seat covers of rubber for vehicles; seat covers of rubber for use in motor vehicles; motor vehicle seats and motor vehicle seat head-rests of rubber; automobile dashboards of rubber; doors and side panels of rubber, namely door panels of rubber for vehicles, automotive interior paneling of rubber, motor vehicle center consoles of rubber, sun visors of rubber for automobiles; self-adhesive plastic foamed webs for lining pedestals, walls and vehicle interiors, namely pedestal linings for land vehicles, interior trim for automobiles; plastic webs for use as safety nets specially adapted for and affixed to off-road recreational and racing vehicles and for use as luggage nets for vehicles; fitted stroller mosquito nets; trunk covers; goods of leather and imitations of leather, namely cushions, boards of leather and imitation of leather, wall coverings, seat covers, vehicle seats and vehicle seat headrests, dashboards, doors and side panels, center consoles, sun visors, all for car interior.

Class 17

(2) Rubber sheets, rubber bars and rods, rubber for use in manufacture, raw rubber, silicone rubber, liquid rubber, semi-worked rubber, foam rubber, natural rubber, synthetic rubber, gutta-percha, raw gum, semiworked gum, asbestos, mica; goods made from these materials, namely cushioning materials of rubber; plastics in extruded form for use in manufacture; packing, stopping and insulating materials, namely rubber packing for shipping container, rubber sheets for packing purposes, joint packing for pipes, graphite packing for gaskets and valves, packing materials of plastic for shipping containers, low-density polyurethane foam for packing, stops of rubber, insulating tape, rubber sheets for insulating purposes, insulating felt, insulating fabrics; surface material of plastic (PVC), namely plastic sheeting for general industrial or manufacturing use, tinted plastic film for use on windows; sound-insulation wall coverings of plastic; rubber and plastic

foils for use in manufacture ; reflective and non-reflective plastic films for use in vehicle windows, laminated plastic films for use on vehicle windows, tinted plastic films for use on vehicle windows.

Class 18

(3) Leather and imitations of leather; animal skins, hides; trunks and travelling bags; umbrellas, parasols and walking sticks; whips, harness and saddlery; leather and imitations of leather for decoration.

Class 24

(4) Mosquito nets.

Class 27

(5) Walls covering of rubber.

Application Number 1,928,062
Language of Application English

Filing Date 2018-10-31

APPLICANT AND AGENT DETAILS

Applicant

ZURU (Singapore) Pte. Ltd
1003, BUKIT MERAH CENTRAL
#06-07, SINGAPORE 159836
SINGAPORE

Agent

BENOÎT & CÔTÉ INC.
560 boul. Crémazie Est, 3e étage, Montréal,
QUEBEC, H2P1E8

TRADEMARK DETAILS

ITTY BITTY PRETTYS

Trademark Type

Word

Goods

Class 28

Toys, games and playthings, namely, dolls, doll clothing and doll accessories; playsets for dolls; cases for toy dolls; toy models; plastic toys, namely, toy figures, toy action figures; character toys, namely, fantasy character toys; collector cases for toys, namely, dolls, toy vehicles, toy models, toy figures, toy action figures and fantasy character toys.

Application Number 1,928,428
Language of Application English

Filing Date 2018-10-29

APPLICANT AND AGENT DETAILS

Applicant

Tire Discounter Group Inc.
65379 County Rd. #3
East Garafraxa
ONTARIO
L9W7J8

Agent

M. LIANNE GORELLE
(CHURCH & FITZPATRICK), BARRISTERS
AND SOLICITORS, 28 FIRST AVENUE,
ORANGEVILLE, ONTARIO, L9W1H8

TRADEMARK DETAILS

Trademark Type

Design

Visual Representation



Colour Claim

Colour is claimed as a feature of the trademark. The colours red, blue, and white are claimed as features of the trademark. Red (PANTONE* Bright Red C, Hex #F93822 RGB: (249,56,34)) is the claimed colour of the middle rectangle (the middle bar of the stylized "E") on the left side of the mark. Blue (PANTONE* 647C, Hex #236192 RGB (35,97,146)) is the claimed colour of the bottom rectangle on the left (the lowest bar of the stylized "E") side of the mark. White is the colour claimed for the uppermost rectangle on the left (the top bar of the stylized "E") and the stylized "D" on the right side of the mark, and the word "EURODESIGN". The background may be any colour other than the claimed colours, and is depicted in black for illustration purposes only. *PANTONE is a registered trademark.

Goods

Class 12

Vehicle wheels; rims for vehicle wheels.

Services

Class 35

(1) Wholesale sale of vehicle tires, rims and wheels.

Class 37

(2) Vehicle tire, rim and wheel installation, repair, rotating and balancing services.

Class 39

(3) Distribution, namely delivery and transport by truck of vehicle tires, rims and wheels.

Application Number 1,928,635
Language of Application English

Filing Date 2018-11-05

APPLICANT AND AGENT DETAILS

Applicant

HAUSBRANDT TRIESTE 1892 SPA
Via Foscarini 52
31040 Nervesa della Battaglia (TV)
ITALY

Agent

MARKS & CLERK
180 Kent Street, Suite 1900, Ottawa,
ONTARIO, K1P0B6

TRADEMARK DETAILS

Trademark Type

Design

Visual Representation



Goods

Class 30

Coffee, tea, cocoa; sugar and honey; coffee beverage flavorings; artificial coffee; coffee-based beverages; cocoa-based beverages; barley tea; honey; crushed barley; ground barley; non-alcoholic chocolate-based beverages; waffles; chocolate; vegetal preparations for use as coffee substitutes; biscuits; tea infusions; herbal tea infusions; fruit tea infusions, nonmedical herbal teas, fruit-based infusions, aromatic preparations for making non-medicated infusions, fruit flavoured tea, other than, medicinal, tisanes namely herbal tea.

Services

Class 35

Layout services for advertising purposes; advertising services for the promotion of production for others, in relation to coffee, tea, cocoa, sugar and honey, coffee flavorings, artificial coffee, coffee-based beverages, tea-based beverages, cocoa-based beverages, barley drinks, honey, crushed barley, ground barley, drinking chocolate, waffles, chocolate, vegetal preparations for use as coffee substitutes, biscuits, infusions, not medicinal, non medical herbal teas, fruit-based infusions, aromatic preparations for making non medicated infusions, fruit flavoured tea, other than medicinal, tisanes; direct mail advertising for others, namely leaflets, prospectuses, printed material, samples; publication of publicity texts; on-line advertising services for others on a

computer internet network; writing of publicity texts; on-line retail services of products in relation to coffee, tea, cocoa, sugar and honey, coffee flavorings, artificial coffee, coffee-based beverages, tea-based beverages, cocoa-based beverages, barley drinks, honey, crushed barley, ground barley, drinking chocolate, waffles, chocolate, vegetal preparations for use as coffee substitutes, biscuits, infusions, not medicinal, nonmedical herbal teas, fruit-based infusions, aromatic preparations for making non-medicated infusions, fruit flavoured tea, other than medicinal, tisanes; retailing or wholesaling of products in relation to coffee, tea, cocoa, sugar and honey, coffee flavorings, artificial coffee, coffee-based beverages, tea-based beverages, cocoa-based beverages, barley drinks, honey, crushed barley, ground barley, drinking chocolate, waffles, chocolate, vegetal preparations for use as coffee substitutes, biscuits, infusions, not medicinal, non-medical herbal teas, fruit-based infusions, aromatic preparations for making non-medicated infusions, fruit flavoured tea, other than medicinal, tisanes; franchising services, namely, consultancy support in the management and organisation of restaurants, bars, cafeterias; retail shop window display arrangement services.

Claims

Priority Filing Date: May 09, 2018, Country or Office: ITALY, Application No: 302018000016470 in association with the same kind of goods and in association with the same kind of services

Application Number 1,928,947
Language of Application English

Filing Date 2018-11-06

APPLICANT AND AGENT DETAILS

Applicant

Boehringer Ingelheim Vetmedica GmbH
55218 Ingelheim
GERMANY

Agent

MARKS & CLERK
33 Yonge Street, , Suite 300, Toronto,
ONTARIO, M5E1G4

TRADEMARK DETAILS

PRRSFLEX

Trademark Type

Word

Goods

Class 05

veterinary vaccines for swine

Application Number 1,930,295
Language of Application English

Filing Date 2018-11-13

APPLICANT AND AGENT DETAILS

Applicant

ALESSI DOMENICO S.P.A., a legal entity
VIA DEI TULIPANI, 3/5
BASSANO DEL GRAPPA (VICENZA)
ITALY

Agent

ROBIC
630, boul. René-Lévesque Ouest, 20e étage,
Montréal, QUEBEC, H3B1S6

TRADEMARK DETAILS

Trademark Type

Design

Visual Representation



Goods

Class 14

(1) Ornamental jewelry pins; jewels; silver, unwrought or beaten; clasps for jewelry; alloys of precious metal; imitation jewelry; jewelry, namely, threads and wires of precious metals; shoe ornaments of precious metal; hat ornaments of precious metal; gold, unwrought or beaten; jewellery charms; personal jewelry, namely, earrings, rings, brooches, medallions, diadems, cufflinks, tie clips, pendants and charms.

(2) Ornamental jewelry chains; personal jewelry, namely, bracelets.

(3) Personal jewelry, namely, necklaces; chokers; ankle bracelets.

Claims

Priority Filing Date: May 22, 2018, Country or Office: ITALY, Application No: 302018000017840 in association with the same kind of goods

Application Number 1,930,562
Language of Application English

Filing Date 2018-11-15

APPLICANT DETAILS

Applicant

TAOYUAN WANG
21B, Building 1, Man Haining South District
New District Avenue No. 1002, Longhua District
Shenzhen, Guangdong
CHINA

TRADEMARK DETAILS

EnergyCable

Trademark Type

Word

Goods

Class 09

battery chargers for use with telephones; camcorders; camera batteries; car video recorders; computer joysticks; computer keyboards; computer mouse; digital door locks; DVD recorders; electric door bells; electric locks for vehicles; fire alarms; firmware for remote monitoring of hardware; global positioning system (GPS) consisting of computers, computer software, transmitters, receivers, and network interface devices; global positioning system (GPS) satellites; mobile phones; mobile telephone batteries; mobile telephones; mouse pads; portable computers; remote controls for televisions; security and fire alarms; selfie stick; smartglasses; stands adapted for mobile phones; surveying instruments; TV monitors; video monitors; voltage regulators for vehicles.

Application Number 1,930,563
Language of Application English

Filing Date 2018-11-15

APPLICANT DETAILS

Applicant

TAOYUAN WANG
21B, Building 1, Man Haining South District
New District Avenue No. 1002, Longhua District
Shenzhen, Guangdong
CHINA

TRADEMARK DETAILS

EnergyCord

Trademark Type

Word

Goods

Class 09

battery chargers for use with telephones; camcorders; camera batteries; car video recorders; computer joysticks; computer keyboards; computer mouse; digital door locks; DVD recorders; electric door bells; electric locks for vehicles; fire alarms; firmware for remote monitoring of hardware; global positioning system (GPS) consisting of computers, computer software, transmitters, receivers, and network interface devices; global positioning system (GPS) satellites; mobile phones; mobile telephone batteries; mobile telephones; mouse pads; portable computers; remote controls for televisions; security and fire alarms; selfie stick; smartglasses; stands adapted for mobile phones; surveying instruments; TV monitors; video monitors; voltage regulators for vehicles.

Application Number 1,930,568
Language of Application English

Filing Date 2018-11-15

APPLICANT DETAILS

Applicant

TAOYUAN WANG
21B, Building 1, Man Haining South District
New District Avenue No. 1002, Longhua District
Shenzhen, Guangdong
CHINA

TRADEMARK DETAILS

EnergyCell

Trademark Type

Word

Goods

Class 09

camcorders; car video recorders; computer joysticks; computer keyboards; computer mouse; digital door locks; DVD recorders; electric door bells; electric locks for vehicles; fire alarms; firmware for remote monitoring of hardware; global positioning system (GPS) consisting of computers, computer software, transmitters, receivers, and network interface devices; global positioning system (GPS) satellites; mobile phones; mobile telephones; mouse pads; portable computers; remote controls for televisions; security and fire alarms; selfie stick; smartglasses; stands adapted for mobile phones; surveying instruments; TV monitors; video monitors; voltage regulators for vehicles

Application Number 1,930,766
Language of Application French

Filing Date 2018-11-15

APPLICANT AND AGENT DETAILS

Applicant

SOLETANCHE FREYSSINET, Société par
actions simplifiée
280 avenue Napoléon Bonaparte
92500 RUEIL-MALMAISON
FRANCE

Agent

LAVERY, DE BILLY, LLP
1 Place Ville Marie, Suite 4000, Montréal,
QUÉBEC, H3B4M4

TRADEMARK DETAILS

BEYOND

Trademark Type

Word

Goods

Class 09

Scientific, surveying, signalling, checking, monitoring and measuring apparatus and instruments, namely analysis instruments for photogrammetry, calibration instruments for hygrometers, surveying instruments for measuring distance, height, amplitude, depth, for surveying, for monitoring civil engineering structures and lands in the fields of construction, engineering, geology, geolocation and soil analysis, measuring sensors, namely distance sensors, height sensors, depth sensors and amplitude sensors, precision measuring apparatus, namely level measuring machines for surveying, apparatus for measuring soil humidity, namely hygrometers, positioning apparatus and instruments, namely global positioning systems [GPSs] consisting of computers, software, transmitters, receivers and network interface units, geolocation apparatus and instruments, namely satellite global positioning system [GPS] receivers, global positioning system [GPS] transmitters, mapping devices, in the nature of measuring and modelling apparatus and instruments for mapping the condition of lands, downloadable software applications for portable computers, smart phones and tablets for managing databases, analyzing geolocation data, analyzing soil, analyzing soil data and viewing data in 3D in the fields of construction, engineering, geology, geolocation and soil analysis, interface software for designing and editing graphics, downloadable computer graphics, computer programs and software for construction and civil engineering for managing databases and analyzing geolocation data, analyzing soil, analyzing soil data and viewing data in 3D in the fields of construction, engineering, geology, geolocation and soil analysis, computer programs and software for analyzing soil, computer programs and software for analyzing building structures and civil engineering structures, decision-making software, namely software for managing databases and analyzing geolocation data, analyzing soil, analyzing soil data and viewing data in 3D in the fields of construction, engineering, geology, geolocation and soil analysis, computer programs and software for managing risks in the construction sector, computer software for assessing and managing geotechnical, environmental and structural risks, mapping software, computer software and programs for geolocation systems, 3D animation software, 3D scanners, 3D viewers, 3D graphics software, 3D image manipulators, namely 3D simulation software for designing and developing industrial products in the fields of construction, engineering, geology, geolocation and soil analysis, computer software for 3D modelling and viewing of data collected

from analyzing soil and building and engineering structures, computer programs (CAD/CAM) recorded on software and designed for use in computer-assisted construction and manufacturing, namely the creation, downloading, transmission, reception, editing of geolocation data, soil analysis, soil data analysis and 3D data viewing in the fields of construction, engineering, geology, geolocation and soil analysis, databases, data processing, transmission, conversion, communication, recording and storage apparatus and equipment, namely computers for recording, storing, managing, transmitting and archiving data related to construction, management of data and computer hardware for network attached storage [NAS], wireless telecommunications devices for the transmission of data, for accessing a navigation service and for downloading data, namely computer hardware for telecommunications, all the aforesaid goods being solely in relation to the fields of construction, engineering, geology, geolocation and soil analysis.

Services

Class 37

(1) Construction services for foundations, buildings and civil engineering structures; construction and demolition of foundations, buildings and civil engineering structures; servicing, repair and maintenance of foundations, buildings and civil engineering structures; construction supervision; advice and provision of information in the field of construction; stabilization, drainage, reclamation and maintenance of soil and subsoil; ground and underground erosion control; well drilling, excavation of trenches and walls in the ground; injection of products in the ground, in particular for stabilization and sealing purposes; installation of frames and tie rods for soil stabilization; earthworks; restoration and rehabilitation of derelict sites.

Class 42

(2) Engineering services in the field of construction, scientific research and analysis in the field of construction, technical advice (engineering) and technical assistance (engineering) for carrying out construction work, drafting of construction plans, advice regarding the safety of foundations, buildings and civil engineering structures, design of buildings and civil engineering structures, building inspection [expert assessments], technical project studies and analysis of technical data in the field of construction, analysis of the structural behaviour of building materials, soil analysis services, chemical analysis of soil, soil sampling for analysis purposes, soil sample measurement, geological sample analysis, conduct of geological tests on developable land, soil testing, monitoring and analysis of the behaviour of building structures, creation of control programs for automatic measurement, assembly, adjustment and viewing activities related thereto in the fields of construction, engineering, geology, geolocation and soil analysis, geotechnical tests, geotechnical, geological and geophysical research, seismographic research, topographic research, topographic surveying services, land exploration and surveying services, mapping services, digital mapping services, surveillance services for contaminated land, design, installation, update, maintenance, rental of computer software in the field of construction, development and design of computer programs for processing geolocation data, analyzing soil, analyzing soil data and viewing data in 3D in the fields of construction, engineering, geology, geolocation and soil analysis, exploration, retrieval, migration, securing, decoding, backup, storage and digital compression of data, hosting of data and databases, maintenance of databases, data conversion of electronic information, computer programming services related to equipment for processing geolocation data, analyzing soil, analyzing soil data and viewing data in 3D in the fields of construction, engineering, geology, geolocation and soil analysis, technical advisory services related to processing geolocation data, analyzing soil, analyzing soil data and viewing data in 3D in

the fields of construction, engineering, geology, geolocation and soil analysis, all the aforementioned services being solely in relation to the fields of construction, engineering, geology, geolocation and soil analysis.

Claims

Priority Filing Date: June 14, 2018, Country or Office: EUIPO (EU), Application No: 017917994 in association with the same kind of goods and in association with the same kind of services

Application Number 1,930,897
Language of Application English

Filing Date 2018-11-16

APPLICANT AND AGENT DETAILS

Applicant

Watkins Manufacturing Corporation
1280 Park Center Drive
Vista, CA 92081
UNITED STATES OF AMERICA

Agent

PIASETZKI NENNIGER KVAS LLP
SUITE 2308, 120 ADELAIDE STREET WEST,
TORONTO, ONTARIO, M5H1T1

TRADEMARK DETAILS

SEYCHELLES

Trademark Type

Word

Goods

Class 11

Hot tubs and spas in the nature of heated pools

Claims

Priority Filing Date: June 11, 2018, Country or Office: UNITED STATES OF AMERICA, Application No: 87/957,214 in association with the same kind of goods

Application Number 1,931,265
Language of Application English

Filing Date 2018-11-19

APPLICANT AND AGENT DETAILS

Applicant

Thales UK Limited
350 Longwater Avenue
Green Park
Reading, Berkshire
RG2 6GF
UNITED KINGDOM

Agent

MARKS & CLERK
180 Kent Street, Suite 1900, Ottawa,
ONTARIO, K1P0B6

TRADEMARK DETAILS

FORCESHIELD

Trademark Type

Word

Goods

Class 09

(1) radars; radar systems; radar control systems; radar and guided missile control systems; missile guidance control systems; air defence systems comprising short-range air defence missiles, radar, weapon coordination systems for launching missiles and guided projectiles, mobile weapon systems for launching missiles and guide projectiles, communications systems for coordinating launching of missiles and guided projectiles, and simulators for training users on operating weapon coordination systems for launching missiles and guided projectiles, mobile weapon systems for launching missiles and guided projectiles, and communications systems for coordinating launching of missiles and guided projectiles; range finders for measuring distances for military and defense weapons, namely guided missiles and projectiles; devices for use in aiming precision guided munitions, guiding missiles and guided projectiles, including for use in training operators of weapons systems; devices for the guidance, homing and aiming of precision guided munitions; directional infrared countermeasure (DIRCM) systems comprising distance, infrared, motion and optical sensors for the determination of temperatures, positions and distances of potential threats, infrared signal transmitters, lasers, and associated computer processing systems for threat detection, threat assessment, and missile tracking, including computer hardware and software for operating the directional infrared countermeasure (DIRCM) systems; weapon warning devices for a radar and engagement control station used with missiles to protect ground forces against aerial infrared-guided missile threats, laser-guided/laser-aided threats, and unguided munitions by providing an audio and visual sector warning to the pilot, including computer hardware and software for operating the weapon warning device; electromagnetic warning devices for a radar and engagement control station used with missiles, to protect ground forces against aerial infrared-guided missile threats, laser-guided/laser-aided threats, and unguided munitions by providing an audio and visual sector warning to the pilot, including computer hardware for operating the electromagnetic warning device; infra-red, heat, homing and target detecting devices, apparatus and equipment for weapons comprising a radar sensor and an imaging sensor for a radar and engagement control station used with missiles; weapons systems for launching missiles and projectiles; computer software for use in aiming weapons, guiding missiles or projectiles, or for use

in training operators of weapons systems; computer software for weapon control, weapon guidance, weapon management and weapon warning; computer software for radar control and management; computer software for missile threat detection and warning; computer software and systems for training weapon operators; parts and fittings, replacement parts and structural parts for radars, radar systems, radar control systems, radar and engagement weapon control systems, missile guidance and control systems.

Class 12

(2) wheeled military vehicles, tanks, trucks, armoured vehicle, military ships, military drones, military planes; parts and fittings, replacement parts and structural parts, for military vehicles for land, sea and air, vehicles for land, sea and air, namely wheeled military vehicles, tanks, trucks, armoured vehicle, military ships, military drones, military planes, carrying radar and engagement weapon control systems, radar vehicles for land, sea and air.

Class 13

(3) missiles, field guns, machine guns, naval guns, and ballistic weapons, fuzed weapons, tear gas weapons, weapons in the form of gas bombs, precision guided munition and air defence and surface attack weapons; armour-piercing projectiles, guided artillery projectiles, guided projectiles, illuminating projectiles, guide projectiles and missiles for air defence and surface attack weapons; cannons; ammunition; explosive firing cartridges; fuses for explosives; detonators; bombs; explosive substances, namely, ammonium nitrate explosives, blasting explosives, explosive cartridges, explosive chargers, warheads and rocket motors; rocket launchers, grenade launchers, mobile launch platforms as part of a vehicle for launching guided projectiles, static installation mobile launch platforms for launching guided projectiles, lightweight portable launchers for launching guided projectiles; shields for gun carriages, protective shields adapted for firearms, sealed containers for storing and protecting weapons, cannisters for storing, protecting, and attaching missiles to platforms, protective cases and carrying cases adapted for use with any of the aforesaid goods; parts and fittings, replacement parts and structural parts for missiles, field guns, machine guns, naval guns, and ballistic weapons, fuzed weapons, tear gas weapons, weapons in the form of gas bombs, precision guided munition and air defence and surface attack weapons, armour-piercing projectiles, guided artillery projectiles, guided projectiles, illuminating projectiles, guide projectiles and missiles for air defence and surface attack weapons, cannons, ammunition, explosive firing cartridges, fuses for explosives, detonators, bombs, explosive substances, namely, ammonium nitrate explosives, blasting explosives, explosive cartridges, explosive chargers, warheads and rocket motors, rocket launchers, grenade launchers, mobile launch platforms as part of a vehicle for launching guided projectiles, static installation mobile launch platforms for launching guided projectiles, lightweight portable launchers for launching guided projectiles, protective shields, and protective cases and carrying cases adapted for use with any of the aforesaid goods.

Claims

Priority Filing Date: November 13, 2018, Country or Office: UNITED KINGDOM, Application No: UK00003353108 in association with the same kind of goods

Application Number 1,931,677
Language of Application English

Filing Date 2018-11-21

APPLICANT AND AGENT DETAILS

Applicant

Twin Cities Public Television, Inc.
172 E. Fourth Street
St. Paul, MN 55101
UNITED STATES OF AMERICA

Agent

DEETH WILLIAMS WALL LLP
150 YORK STREET, SUITE 400, TORONTO,
ONTARIO, M5H3S5

TRADEMARK DETAILS

HERO ELEMENTARY

Trademark Type

Standard Characters

Goods

Class 09

(1) Downloadable game software for use in connection with computers, mobile communication devices for early childhood learning and entertainment; pre-recorded laser and video discs featuring children's entertainment programs in the nature of movies, television shows, computer games, video games, educational puzzles, and music.

Class 16

(2) Children's activity books, coloring books, note cards, note paper, decals, trading cards, posters, notebooks, folders, namely paper folders, stationery folders, presentation folders, blank journals, diaries, personal day planners, bookmarks, pencil cases, erasers, pencil sharpeners, marker pens, drawing rulers, pencils, pens, arts and crafts paint kits, calendars, greeting cards, paper party decorations, paper napkins, paper ribbons, paper party bags, gift wrapping paper, paper party decorations, paper party bags; series of fiction books in the field of children's entertainment

Class 18

(3) Umbrellas, luggage tags, tote bags, backpacks, fanny packs, messenger bags, handbags, wallets, athletic bags, coin purses, duffle bags, beach bags

Class 25

(4) Clothing, namely sweatshirts, t-shirts and hats

Class 28

(5) Toys and games, namely action figures and accessories for use therewith

Services

Class 41

(1) Entertainment services, namely, providing entertainment and education for children in the field of early childhood learning and early childhood entertainment via a website featuring non-downloadable interactive games and computer applications in the nature of educational puzzles and games, colouring books, card games, video games, animated cartoons and comics; providing online non-downloadable computer games in the field of early childhood learning and entertainment

(2) Educational and entertainment services, namely, ongoing programs in the form of television shows, webcasts, and webisodes, in the field of children's entertainment, accessible by television, satellite, audio, video electronic media, and computer networks

Claims

Priority Filing Date: May 23, 2018, Country or Office: UNITED STATES OF AMERICA, Application No: 87933717 in association with the same kind of services (2); May 23, 2018, Country or Office: UNITED STATES OF AMERICA, Application No: 87933713 in association with the same kind of goods and in association with the same kind of services (1)

Application Number 1,931,681
Language of Application English

Filing Date 2018-11-21

APPLICANT AND AGENT DETAILS

Applicant

Twin Cities Public Television, Inc.
172 E. Fourth Street
St. Paul, MN 55101
UNITED STATES OF AMERICA

Agent

DEETH WILLIAMS WALL LLP
150 YORK STREET, SUITE 400, TORONTO,
ONTARIO, M5H3S5

TRADEMARK DETAILS

PRIMARIA DE HÉROES

Trademark Type

Standard Characters

Foreign Character Translation

As provided by the applicant, the mark translates from Spanish to English as "hero elementary".

Goods

Class 09

(1) Downloadable game software for use in connection with computers, mobile communication devices for early childhood learning and entertainment; pre-recorded laser and video discs featuring children's entertainment programs in the nature of movies, television shows, computer games, video games, educational puzzles, and music.

Class 16

(2) Children's activity books, coloring books, note cards, note paper, decals, trading cards, posters, notebooks, folders, namely paper folders, stationery folders, presentation folders, blank journals, diaries, personal day planners, bookmarks, pencil cases, erasers, pencil sharpeners, marker pens, drawing rulers, pencils, pens, arts and crafts paint kits, calendars, greeting cards, paper party decorations, paper napkins, paper ribbons, paper party bags, gift wrapping paper, paper party decorations, paper party bags; series of fiction books in the field of children's entertainment

Class 18

(3) Umbrellas, luggage tags, tote bags, backpacks, fanny packs, messenger bags, handbags, wallets, athletic bags, coin purses, duffle bags, beach bags

Class 25

(4) Clothing, namely sweatshirts, t-shirts and hats

Class 28

(5) Toys and games, namely action figures and accessories for use therewith

Services

Class 41

(1) Educational and entertainment services, namely, ongoing programs in the form of television shows, webcasts, and webisodes, in the field of children's entertainment, accessible by television, satellite, audio, video electronic media, and computer networks

(2) Entertainment services, namely, providing entertainment and education for children in the field of early childhood learning and early childhood entertainment via a website featuring non-downloadable interactive games and computer applications in the nature of educational puzzles and games, colouring books, card games, video games, animated cartoons and comics; providing online non-downloadable computer games in the field of early childhood learning and entertainment

Claims

Priority Filing Date: May 23, 2018, Country or Office: UNITED STATES OF AMERICA, Application No: 87933708 in association with the same kind of services (1); May 23, 2018, Country or Office: UNITED STATES OF AMERICA, Application No: 87933699 in association with the same kind of goods and in association with the same kind of services (2)

Application Number 1,931,789
Language of Application English

Filing Date 2018-11-21

APPLICANT AND AGENT DETAILS

Applicant

COMPASS MINERALS USA INC.
9900 West 109th Street, Suite 100
Overland Park, KS 66210-1436
UNITED STATES OF AMERICA

Agent

GOWLING WLG (CANADA) LLP
550 BURRARD STREET, SUITE 2300,
VANCOUVER, BRITISH COLUMBIA, V6C2B5

TRADEMARK DETAILS

Trademark Type

Design

Visual Representation



Colour Claim

Colour is claimed as a feature of the trade-mark. The words COMPASS MINERALS are black, the semi-circle formed by horizontal lines that taper from left to right are cyan.

Goods

Class 01

(1) Fertilizers; food grade salt for general industrial use, namely sodium chloride; salt and trace mineral salt for animal consumption; de-icing and ice prevention preparation for roadways and sidewalks and other paved surfaces; salt for water softeners; water softening compounds; water treatment chemicals for use in swimming pools and spas

Class 04

(2) Liquid preparations applied to road surfaces to control dust

Class 05

(3) Animal feed supplements

Class 30

(4) Salt; food grade salt for food manufacturing and food processing

Class 31

(5) Salt and trace mineral salt for animal consumption

Application Number 1,932,009
Language of Application English

Filing Date 2018-11-22

APPLICANT AND AGENT DETAILS

Applicant

Chan Zuckerberg Initiative, LLC
2682 Middlefield Road, Suite i
Redwood City, California 94063
UNITED STATES OF AMERICA

Agent

SMART & BIGGAR LLP
1100-150 York street, TORONTO, ONTARIO,
M5H3S5

TRADEMARK DETAILS

CZI

Trademark Type

Standard Characters

Services

Class 35

(1) public advocacy, namely, advertising services to promote public awareness in the fields of health, medical and scientific laboratory research, computer programming technology, literacy, immigration reform, child welfare, agricultural and horticultural sustainability and community engagement activities; arranging, organizing and conducting exhibitions to promote the exchange of information within the scientific and medical research community and the computer programming technology industry to achieve advances in the field of health, medical and scientific laboratory research, computer programming technology, literacy, immigration reform, child welfare, agricultural and horticultural sustainability, and community engagement activities

Class 36

(2) philanthropic services, namely, providing investment management services to support advancements in the fields of health, medical and scientific research, computer technology, literacy, immigration reform, child welfare, sustainability, and community building; financing services, namely, providing grants in the fields of health, education, medical and scientific research, technology, immigration, justice, and community engagement activities, charitable fund-raising campaigns, venture capital financing, investment fund distribution and administration; capital investment services; philanthropic consultation services in the field of charitable fund-raising campaigns, namely, administration and coordination of charitable fund-raising campaigns and raising and accepting of monetary and non-monetary charitable contributions to fund medical and scientific research

Claims

Priority Filing Date: May 22, 2018, Country or Office: UNITED STATES OF AMERICA, Application No: 87/931,651 in association with the same kind of services (2); May 22, 2018, Country or Office: UNITED STATES OF AMERICA, Application No: 87/931,672 in association with the same kind of services (1)

Application Number 1,932,010
Language of Application English

Filing Date 2018-11-22

APPLICANT AND AGENT DETAILS

Applicant

Chan Zuckerberg Initiative, LLC
2682 Middlefield Road, Suite i
Redwood City, California 94063
UNITED STATES OF AMERICA

Agent

SMART & BIGGAR LLP
1100-150 York street, TORONTO, ONTARIO,
M5H3S5

TRADEMARK DETAILS

Trademark Type

Design

Visual Representation



Services

Class 35

(1) public advocacy, namely, advertising services to promote public awareness in the fields of health, medical and scientific laboratory research, computer programming technology, literacy, immigration reform, child welfare, agricultural and horticultural sustainability and community engagement activities; arranging, organizing and conducting exhibitions to promote the exchange of information within the scientific and medical research community and the computer programming technology industry to achieve advances in the field of health, medical and scientific laboratory research, computer programming technology, literacy, immigration reform, child welfare, agricultural and horticultural sustainability, and community engagement activities

Class 36

(2) philanthropic services, namely, providing investment management services to support advancements in the fields of health, medical and scientific research, computer technology, literacy, immigration reform, child welfare, sustainability, and community building; financing services, namely, providing grants in the fields of health, education, medical and scientific research, technology, immigration, justice, and community engagement activities, charitable fund-

raising campaigns, venture capital financing, investment fund distribution and administration; capital investment services; philanthropic consultation services in the field of charitable fund-raising campaigns, namely, administration and coordination of charitable fund-raising campaigns and raising and accepting of monetary and non-monetary charitable contributions to fund medical and scientific research

Claims

Priority Filing Date: May 22, 2018, Country or Office: UNITED STATES OF AMERICA, Application No: 87/931,708 in association with the same kind of services (2); May 22, 2018, Country or Office: UNITED STATES OF AMERICA, Application No: 87/931,696 in association with the same kind of services (1)

Application Number 1,932,011
Language of Application English

Filing Date 2018-11-22

APPLICANT AND AGENT DETAILS

Applicant

Chan Zuckerberg Initiative, LLC
2682 Middlefield Road, Suite i
Redwood City, California 94063
UNITED STATES OF AMERICA

Agent

SMART & BIGGAR LLP
1100-150 York street, TORONTO, ONTARIO,
M5H3S5

TRADEMARK DETAILS

Trademark Type

Design

Visual Representation

**Chan
Zuckerberg
Initiative** 

Services

Class 35

(1) public advocacy, namely, advertising services to promote public awareness in the fields of health, medical and scientific laboratory research, computer programming technology, literacy, immigration reform, child welfare, agricultural and horticultural sustainability and community engagement activities; arranging, organizing and conducting exhibitions to promote the exchange of information within the scientific and medical research community and the computer programming technology industry to achieve advances in the field of health, medical and scientific laboratory research, computer programming technology, literacy, immigration reform, child welfare, agricultural and horticultural sustainability, and community engagement activities

Class 36

(2) philanthropic services, namely, providing investment management services to support advancements in the fields of health, medical and scientific research, computer technology, literacy, immigration reform, child welfare, sustainability, and community building; financing services, namely, providing grants in the fields of health, education, medical and scientific research, technology, immigration, justice, and community engagement activities, charitable fund-raising campaigns, venture capital financing, investment fund distribution and administration; capital investment services; philanthropic consultation services in the field of charitable fund-raising campaigns, namely, administration and coordination of charitable fund-raising campaigns and raising and accepting of monetary and non-monetary charitable contributions to fund medical and scientific research

Claims

Priority Filing Date: May 22, 2018, Country or Office: UNITED STATES OF AMERICA, Application No: 87/931,769 in association with the same kind of services (2); May 22, 2018, Country or Office: UNITED STATES OF AMERICA, Application No: 87/931,679 in association with the same kind of services (1)

Application Number 1,932,016
Language of Application English

Filing Date 2018-11-22

APPLICANT AND AGENT DETAILS

Applicant

ZAIDI FOODS INC
86 Torgan Trail
Kleinburg
ONTARIO
L4H3X6

Agent

DLA PIPER (CANADA) LLP
1 FIRST CANADIAN PLACE, SUITE 6000, P.
O. BOX 367, 100 KING STREET WEST,
TORONTO, ONTARIO, M5X1E2

TRADEMARK DETAILS

Trademark Type

Design

Visual Representation



Goods

Class 29

(1) Barbequed foods, namely shish kabobs, mutton, chicken, beef; Fried foods, namely falafel, fish, French fries, chicken wings; Breakfast food namely eggs, omelettes; Seafood namely, fish, prawns; soups; Salads, namely vegetable salads, Greek salads, Tabouleh, Fattoush; Hummus; Baba Ganoush; Milk, lassi.

Class 30

(2) Sandwiches, namely hamburgers, pitas; Desserts namely baklava, cake, cheesecake, mousse, ice cream; Breakfast food namely, French toast, cereal; Breads, namely pita bread, naan bread; Nachos; Rice.

Class 32

(3) Beverages namely, coffee, tea, soft drinks, lemonade, fruit juices, iced tea, mineral and flavoured waters.

Services

Class 43

Restaurant services, namely the preparation and service of foods and beverages in restaurant establishments; Take-away restaurant services; Catering services; Buffet services; Bistro services; Coffee shop services; Cafeteria services; Café services.

Application Number 1,932,032
Language of Application English

Filing Date 2018-11-22

APPLICANT AND AGENT DETAILS

Applicant

Kefir Kultures Inc.
55 De Boers Dr.
PH10
North York
ONTARIO
M3J0G5

Agent

OSLER, HOSKIN & HARCOURT LLP
SUITE 1900, 340 ALBERT STREET,
OTTAWA, ONTARIO, K1R7Y6

TRADEMARK DETAILS

Trademark Type

Design

Visual Representation



Colour Claim

Colour is claimed as a feature of the trademark. The circular design that surrounds the middle text is black. The letters and numbers 'KEFIRKULT' and 'SINCE 2014' that form part of the circular design are also black. The middle section, namely the raindrop icon and the word FERMENTING are orange.

Goods

Class 01

(1) bacteria for use in food manufacture; bacteria for use in food manufacturing; bacteria for use in the manufacture of food; probiotic bacteria for the food industry; probiotic bacterial cultures for the food industry

Class 29

(2) kefir

(3) kefir milk; coconut kefir milk

Application Number 1,932,420
Language of Application English

Filing Date 2018-11-26

APPLICANT AND AGENT DETAILS

Applicant

YOUNG POONG CO., LTD.
64, Seongseogongdanbuk-ro
Dalseo-gu
Daegu, 42712
REPUBLIC OF KOREA

Agent

MACRAE & CO.
326 Somerset Street West, Ottawa, ONTARIO,
K2P0J9

TRADEMARK DETAILS

Trademark Type

Design

Visual Representation



Colour Claim

Colour is claimed as a feature of the trademark. The word YOPOKKI is red. The Korean characters are brown and the rounded rectangular shape with the three prongs above the characters is red.

Foreign Character Transliteration

The transliteration provided by the applicant of the Korean characters is "YO" and "POKKI".

Goods

Class 30

Ready-to-eat cereals; Stick of rounded rice cakes (garaetteok); Dried pasta; Cereal-based snack food; Rice cakes; Rice cake for sliced Rice Cake Soup; Cooked dish consisting primarily of stir-fried rice cake with fermented hot pepper paste (Topokki); Rice cakes for stir-fried rice cake; Instant noodles; Stir-fried rice cake with ramen noodles (rabokki); Risotto; Noodles; Mung bean pancake (Bindaetteok); Bread; Spaghetti; Pasta; Cooked dish consisting primarily of dough flakes with broth (Sujebi)

Application Number 1,932,497
Language of Application English

Filing Date 2018-11-26

APPLICANT AND AGENT DETAILS

Applicant

24-7 Intouch Inc.
200 - 240 Kennedy Street
Winnipeg
MANITOBA
R3C1T1

Agent

MLT AIKINS LLP
2100 Livingston Place, 222-3rd Avenue SW,
Calgary, ALBERTA, T2P0B4

TRADEMARK DETAILS

Trademark Type

Design

Visual Representation



Goods

Class 09

(1) Downloadable application software used for assisting agents in the fields of predictive systems, cognitive process automation, visual computing applications, knowledge virtualization, robotics and with digital virtual agents used in contact centers.

(2) Workforce management application software for use in the centralization of time, schedule, and compensation management, and employee engagement; downloadable software application for use in the centralization of workflow management, compensation management, time and scheduling management with employees for contact centers; computer software for use in contact centers for database management; downloadable cloud computer software for use in contact centers for database management.

(3) Computer software for assisting developers in creating program code for use in mobile internet applications and client interfaces.

Services

Class 35

(1) Outsourcing service provider in the field of customer relationship management in the areas of inbound voice, email, chat, social media messages; global outsourcing support services for others in the fields of of customer relationship management, business process reengineering services and back office support, namely, business administration consulting, documentation reproduction, documentation copying tasks, documentation indexing for others, consulting and customer

analytics, namely, market analysis, process analytics in the nature of the development and the implementation of strategy plans and management projects, all in the area of contact center services.

Class 42

(2) Research and development in the field of artificial intelligence technology in the area of customer relationship management services; research and development in the field of machine learning, automated voice messaging in the area of customer relationship management; design of an intelligent virtual assistant software for use in the area of customer relationship management; design and development of computer software for data analytics and advanced product research in the field of artificial intelligence and machine learning; design, development of robots with artificial intelligence; development and implementation of an intelligent virtual assistant software for use in customer support services; development and implementation of computer software to be used for call diversion, for automated call screening, and for voice recognition in the field of artificial intelligence and machine learning; development of software applications for managing automated workflow tasks over the Internet; platform as a service (PAAS) featuring computer software platforms for contact center management.

Application Number 1,932,499
Language of Application English

Filing Date 2018-11-26

APPLICANT AND AGENT DETAILS

Applicant

24-7 Intouch Inc.
200 - 240 Kennedy Street
Winnipeg
MANITOBA
R3C1T1

Agent

MLT AIKINS LLP
2100 Livingston Place, 222-3rd Avenue SW,
Calgary, ALBERTA, T2P0B4

TRADEMARK DETAILS

24-7 INTOUCH

Trademark Type

Word

Goods

Class 09

(1) Downloadable application software used for assisting agents in the fields of predictive systems, cognitive process automation, visual computing applications, knowledge virtualization, robotics and with digital virtual agents used in contact centers.

(2) Workforce management application software for use in the centralization of time, schedule, and compensation management, and employee engagement; downloadable software application for use in the centralization of workflow management, compensation management, time and scheduling management with employees for contact centers; computer software for use in contact centers for database management; downloadable cloud computer software for use in contact centers for database management.

(3) Computer software for assisting developers in creating program code for use in mobile internet applications and client interfaces.

Services

Class 35

(1) Outsourcing service provider in the field of customer relationship management in the areas of inbound voice, email, chat, social media messages; global outsourcing support services for others in the fields of of customer relationship management, business process reengineering services and back office support, namely, business administration consulting, documentation reproduction, documentation copying tasks, documentation indexing for others, consulting and customer analytics, namely, market analysis, process analytics in the nature of the development and the implementation of strategy plans and management projects, all in the area of contact center services.

Class 42

(2) Research and development in the field of artificial intelligence technology in the area of customer relationship management services; research and development in the field of machine learning, automated voice messaging in the area of customer relationship management; design of

an intelligent virtual assistant software for use in the area of customer relationship management; design and development of computer software for data analytics and advanced product research in the field of artificial intelligence and machine learning; design, development of robots with artificial intelligence; development and implementation of an intelligent virtual assistant software for use in customer support services; development and implementation of computer software to be used for call diversion, for automated call screening, and for voice recognition in the field of artificial intelligence and machine learning; development of software applications for managing automated workflow tasks over the Internet; platform as a service (PAAS) featuring computer software platforms for contact center management.

Application Number 1,932,623
Language of Application English

Filing Date 2018-11-27

APPLICANT AND AGENT DETAILS

Applicant

Adeena Wisenthal
215-1568 Merivale Road
Ottawa,
ONTARIO
K2G3J9

Agent

DARRYL JOSEPH BILODEAU
(DB BUSINESS LAW/TM CENTRAL), 104
ROTHESAY DRIVE, KANATA, ONTARIO,
K2L2X1

TRADEMARK DETAILS

ERGO-WISE

Trademark Type

Word

Services

Class 41

(1) Educational services, namely provision of instructional seminars and workshops in the fields of workplace mental health, duty to accommodate, and ergonomics; coaching services in the field of stress management, effective communications, organizational skills, pain management, work-life balance and healthy living

Class 44

(2) Rehabilitation services, namely the provision of occupational therapy and counselling services within the fields of workplace mental health and disability management; Return-to-work preparation, namely providing occupational therapy to employees in the nature of the cognitive work hardening treatment intervention, which takes into consideration the rebuilding of an employee's work stamina and cognitive abilities, the development of an employee's workplace coping strategies, return-to-work planning, workplace ergonomics and the employee's accommodation needs, all with a view to increasing return-to-work success; Providing occupational functioning assessments, namely for determining the specific cognitive demands of a particular position with a particular employer taking into consideration an employee's work ability, work potential, functional limitations and job accommodations; Providing workplace accommodation assessments, namely for optimizing the performance and comfort of employees with disabilities taking into consideration an employee's essential job duties, disability related limitations, and job accommodations; Counselling services, namely stress management, effective communication, organizational skills, pain management, work-life balance and healthy living; Ergonomic assessment services

Application Number 1,932,625
Language of Application English

Filing Date 2018-11-27

APPLICANT AND AGENT DETAILS

Applicant

Adeena Wisenthal
215-1568 Merivale Road
Ottawa
ONTARIO
K2G3J9

Agent

DARRYL JOSEPH BILODEAU
(DB BUSINESS LAW/TM CENTRAL), 104
ROTHESAY DRIVE, KANATA, ONTARIO,
K2L2X1

TRADEMARK DETAILS

Trademark Type

Design

Visual Representation

ERGO-Wise

Services

Class 41

(1) Educational services, namely provision of instructional seminars and workshops in the fields of workplace mental health, duty to accommodate, and ergonomics; coaching services in the field of stress management, effective communications, organizational skills, pain management, work-life balance and healthy living

Class 44

(2) Rehabilitation services, namely the provision of occupational therapy and counselling services within the fields of workplace mental health and disability management; Return-to-work preparation, namely providing occupational therapy to employees in the nature of the cognitive work hardening treatment intervention, which takes into consideration the rebuilding of an employee's work stamina and cognitive abilities, the development of an employee's workplace coping strategies, return-to-work planning, workplace ergonomics and the employee's accommodation needs, all with a view to increasing return-to-work success; Providing occupational functioning assessments, namely for determining the specific cognitive demands of a particular position with a particular employer taking into consideration an employee's work ability, work potential, functional limitations and job accommodations; Providing workplace accommodation assessments, namely for optimizing the performance and comfort of employees with disabilities taking into consideration an employee's essential job duties, disability related limitations, and job accommodations; Counselling services, namely stress management, effective communication, organizational skills, pain management, work-life balance and healthy living; Ergonomic assessment services

Application Number 1,932,626
Language of Application English

Filing Date 2018-11-27

APPLICANT AND AGENT DETAILS

Applicant

Adeena Wisenthal
215-1568 Merivale Road
Ottawa
ONTARIO
K2G3J9

Agent

DARRYL JOSEPH BILODEAU
(DB BUSINESS LAW/TM CENTRAL), 104
ROTHESAY DRIVE, KANATA, ONTARIO,
K2L2X1

TRADEMARK DETAILS

Supporting people ... improving function

Trademark Type

Word

Services

Class 41

(1) Educational services, namely provision of instructional seminars and workshops in the fields of workplace mental health, duty to accommodate, and ergonomics; coaching services in the field of stress management, effective communications, organizational skills, pain management, work-life balance and healthy living

Class 44

(2) Rehabilitation services, namely the provision of occupational therapy and counselling services within the fields of workplace mental health and disability management; Return-to-work preparation, namely providing occupational therapy to employees in the nature of the cognitive work hardening treatment intervention, which takes into consideration the rebuilding of an employee's work stamina and cognitive abilities, the development of an employee's workplace coping strategies, return-to-work planning, workplace ergonomics and the employee's accommodation needs, all with a view to increasing return-to-work success; Providing occupational functioning assessments, namely for determining the specific cognitive demands of a particular position with a particular employer taking into consideration an employee's work ability, work potential, functional limitations and job accommodations; Providing workplace accommodation assessments, namely for optimizing the performance and comfort of employees with disabilities taking into consideration an employee's essential job duties, disability related limitations, and job accommodations; Counselling services, namely stress management, effective communication, organizational skills, pain management, work-life balance and healthy living; Ergonomic assessment services

Application Number 1,932,661
Language of Application English

Filing Date 2018-11-27

APPLICANT AND AGENT DETAILS

Applicant

NZXT, INC.
15736 E. Valley Blvd.
City of Industry, California 91744
UNITED STATES OF AMERICA

Agent

PIASETZKI NENNIGER KVAS LLP
SUITE 2308, 120 ADELAIDE STREET WEST,
TORONTO, ONTARIO, M5H1T1

TRADEMARK DETAILS

H-SERIES

Trademark Type

Word

Goods

Class 09

Computer cases; computer hardware; computer peripheral devices, namely wireless speaker microphones, headsets with microphone, computer mouse pads, storage containers for headsets and computer cables, magnetic pucks attached to a computer case for mounting headsets and organizing computer cables; computers; desktop computers; power adapters for computers

Claims

Priority Filing Date: May 31, 2018, Country or Office: UNITED STATES OF AMERICA, Application No: 87/943,953 in association with the same kind of goods

Application Number 1,932,764
Language of Application English

Filing Date 2018-11-27

APPLICANT AND AGENT DETAILS

Applicant

Gaming Laboratories International, LLC
600 Airport Road
Lakewood, NJ 08701
UNITED STATES OF AMERICA

Agent

MCCARTHY TETRAULT LLP
745 Thurlow Street, Suite 2400, VANCOUVER,
BRITISH COLUMBIA, V6E0C5

TRADEMARK DETAILS

GAMING LABORATORIES INTERNATIONAL

Trademark Type

Word

Services

Class 35

(1) Business auditing in the nature of electronic gaming and lottery devices, gaming, lottery and pari-mutuel systems and consulting services related thereto; business auditing; business auditing in the fields of gaming, iGaming, gambling, Internet gambling, lottery, pari-mutuel, esports, sports wagering, and consulting services related thereto; business consultancy services relating to business continuity, disaster planning and recovery; information, advisory, support and consultancy services in the fields of business continuity, disaster planning and recovery, and business auditing

Class 41

(2) Educational and training services in the fields of electronic gaming, video gaming, iGaming, gambling, internet gambling, lottery, pari-mutuel, esports, and sports wagering; online educational and training services in the fields of electronic gaming, video gaming, iGaming, gambling, internet gambling, lottery, pari-mutuel, esports, and sports wagering; training and educational services in the fields of computer hardware, computer software, information technology (IT) systems namely computer and computer network systems, information technology (IT) services namely computer and computer network services, and cyber security; arranging and conducting seminars, classes, workshops and training sessions in the fields of computer hardware, computer software, information technology (IT) systems namely computer and computer network systems, information technology (IT) services namely computer and computer network services, and cyber security; providing information and training in the fields of iGaming, gambling, internet gambling, lottery, pari-mutuel, esports, and sports wagering; information, advisory, support and consultancy services in the fields of iGaming, gambling, internet gambling, lottery, pari-mutuel, esports, and sports wagering

Class 42

(3) Scientific and technological services, namely, analysis and testing of goods and services of others in the fields of electronic gaming, video gaming, iGaming, gambling, internet gambling, lottery, pari-mutuel, esports, and sports wagering, and research and design relating thereto; scientific and technological services, namely, analysis and testing of goods and services of others

in the fields of electronic gaming, video gaming, iGaming, gambling, internet gambling, lottery, pari-mutuel, esports and sports wagering to determine conformity with certification standards; scientific and technological services, namely, testing, analysis and evaluation of the services of others to determine conformity with certification standards; scientific and technological services, namely, testing, analysis, and evaluation of goods or services of others in the fields of gaming, iGaming, gambling, internet gambling, lottery, pari-mutuel, esports and sports wagering to the order and specification of businesses, governments, and regulatory entities; scientific and technological services, namely, analysis and testing of goods and services in the fields of electronic gaming, video gaming, iGaming, gambling, internet gambling, lottery, pari-mutuel, esports and sports wagering, and research and design relating thereto; industrial analysis and research services, namely, research, testing, analysis, and evaluation of goods and services of others to assure compliance with industry, regulatory, legal, business and certification standards; industrial analysis and research services, namely, research, testing, analysis, and evaluation of goods and services of others to determine conformity with certification standards; industrial analysis and research services, namely, evaluation of goods or services of others in the fields of gaming, iGaming, gambling, internet gambling, lottery, pari-mutuel, esports and sports wagering to the order and specification of businesses, governments, and regulatory entities; industrial analysis and research services, namely, research, testing, analysis, and evaluation of goods and services of others to assure compliance with industry, regulatory, legal, business and certification standards in the fields of gaming, iGaming, gambling, internet gambling, lottery, pari-mutuel, esports and sports wagering; services of quality control and testing of electronic game apparatus, of programs for electronic games, of lottery games and games of chance on behalf of national or governmental gaming regulatory authorities; certification services, namely, services of checking legality and approval of electronic game apparatus, of programs for electronic games, of lottery games and games of chance on behalf of national or governmental gaming regulatory authorities; technological certification services, namely, services of checking legality and approval of electronic game apparatus, of programs for electronic games, of lottery games and games of chance on behalf of national or governmental gaming regulatory authorities; testing and inspecting the functionality of electronic gaming and lottery devices, gaming lottery and pari-mutuel systems and associated equipment and consulting services related thereto; testing, analysis and evaluation of gaming equipment and gaming software of others for the purpose of certification obtained over a wireless communication device; providing remote testing, checking and certifying services in relation to gaming machines, electronic game apparatus, electronic games, lottery games, games of chance, slot machines and video slot machines; information technology (IT) consulting services, namely, consulting services in the fields of computer and computer network systems and services; IT compliance management, namely, testing, analysis, and evaluation of the software and information technology (IT) systems namely computer and telecommunication systems, of others to assure compliance with industry and certification standards; quality auditing, namely, product quality testing services in the fields of electronic gaming, video gaming, iGaming, gambling, internet gambling, lottery, pari-mutuel, esports and sports wagering; IT certification services, namely, testing, analysis and evaluation of information technology (IT) systems namely computer and telecommunication systems of others to determine conformity with certification standards; certification services for computer hardware, computer software, information technology (IT) systems namely computer and telecommunication systems, information technology (IT) services namely computer and telecommunication services, data and cyber security; testing, auditing, analysis and evaluation services for the certification of computer hardware, computer software, information technology (IT) systems namely computer and telecommunication systems, information technology (IT) namely computer and telecommunication, data and cyber security; information, advisory, support and consultancy services in the fields of computer hardware,

computer software, and the testing, analysis and certification of goods and services of others in the fields of electronic gaming, video gaming, iGaming, gambling, internet gambling, lottery, and pari-mutuel

Class 45

(4) Security incident response and investigation services; reviewing standards and practices to assure compliance with laws and regulations in the fields of gaming, iGaming, gambling, internet gambling, parimutuel, lottery, esports, and sports wagering; interviewing of staff for security purposes; conducting staff interviews to assess and ascertain the unauthorised accessibility of sensitive information and data; physical security consulting services, namely, reviewing training material and records to assess and ascertain the unauthorised accessibility of sensitive information and data for businesses and organizations; information, advisory, support and consultancy services relating to compliance with laws and regulations in the fields of gaming, iGaming, gambling, internet gambling, pari-mutuel, lottery, esports, and sports wagering

Claims

Priority Filing Date: May 29, 2018, Country or Office: UNITED STATES OF AMERICA, Application No: 87939567 in association with the same kind of services

Application Number 1,932,835
Language of Application French

Filing Date 2018-11-28

APPLICANT AND AGENT DETAILS

Applicant

Alamo Group Inc.
1627 East Walnut Street
Seguin, TX 78155
UNITED STATES OF AMERICA

Agent

NORTON ROSE FULBRIGHT CANADA LLP/S.
E.N.C.R.L., S.R.L.
1, Place Ville Marie, Suite 2500, Montreal,
QUEBEC, H3B1R1

TRADEMARK DETAILS

Trademark Type

Design

Visual Representation

DENIS  **CIMAF**

Goods

Class 07

Machines, pièces de machine et accessoires de machine pour la foresterie, l'agriculture et la construction, notamment débroussailleuses et déchiqueteuses frontales pour chargeuses compactes, débroussailleuses et déchiqueteuses sur perches, débroussailleuses et faucheuses industrielles, servocommandes hydrauliques pour excavatrices, bulldozers, notamment bulldozers et bulldozers sur pneus, niveleuses, chargeuses, notamment chargeuses à roues et grues forestières, tracteurs agricoles, dents déchiqueteuses, supports pour dents déchiqueteuses, tambours déchiqueteurs.

Services

Class 40

Fabrication de machines, de pièces de machine et d'accessoires de machine pour la foresterie, l'agriculture et la construction selon les commandes et les spécifications de tiers.

Application Number 1,932,850
Language of Application English

Filing Date 2018-11-28

APPLICANT DETAILS

Applicant

Crypto Farm Corp.
248 Birchwood Ave
Tiverton
ONTARIO
N0G2T0

TRADEMARK DETAILS

Trademark Type

Design

Visual Representation



Goods

Class 09

Computer application software for servers, computers and mobile devices, namely, software for facilitating and managing digital currency and financial transactions; computer software for secure aggregation, processing and analyzing data for the purpose of providing customized tracking and reporting in the field of finance, digital currency and cryptocurrency; computer software for the exchange of digital currency and cryptocurrency; computer software for the secure storage of financial information, digital currency and cryptocurrency; computer software for financial, digital currency and cryptocurrency transactions; computer software for secure mining, tracking and storage of digital currency and cryptocurrency; computer software platforms for the design, testing, deployment and management of blockchain systems; computer software platforms for the deployment, transfer and management of digital currency and cryptocurrency; computer software for creating, managing, storing, analyzing and providing data on distributed public ledgers and peer-to-peer payment networks in the fields of cryptocurrency, digital currency, and blockchain based technologies

Services

Class 42

Software as a service (SAAS) services featuring software for digital currency transactions, cryptocurrency transactions, and online financial transactions; Software as a service (SAAS) services featuring software for database management and file management; computer security services in the nature of providing secure and optimized data storage in the field of digital

currency, cryptocurrency and blockchain; advisory services in the field of product development and quality improvement of software; Platform as a service (PAAS) services featuring a software and a platform for the development, quality improvement and optimization of software; Platform as a service (PAAS) services featuring a software and a platform for authenticating, facilitating, matching, processing, clearing, storing, receiving, tracking, transferring and submitting financial transaction data; collaborative computer programming for others in the nature of blockchain development and digital security optimization; computer services, namely, remote management of information technology (IT) systems of others comprised of digital currency, cryptocurrency and blockchain; computer software development; computer software design; computer software development in the field of mobile applications; computer software development in the field of digital currency and cryptocurrency creation and mining, and blockchain; computer programming and maintenance of computer software for digital currency and cryptocurrency mining and blockchain purposes; customizing computer software by developing custom blockchain technology and applications; product design and development in the field of digital currency, cryptocurrency and blockchain technology; consulting services in the field of electrical power generation, namely, designing systems for power generation, transmission and distribution; designing computer hardware and equipment for others for the purposes of electrical power generation, transmission and distribution

Application Number 1,932,879
Language of Application English

Filing Date 2018-11-28

APPLICANT AND AGENT DETAILS

Applicant

SAPREA
4101 North Thanksgiving Way
Suite 100
Lehi, UT 84043
UNITED STATES OF AMERICA

Agent

JENSEN IP
103 - 2150 Thurston Drive, Ottawa, ONTARIO,
K1G5T9

TRADEMARK DETAILS

FINDING HOPE

Trademark Type

Word

Services

Class 45

Providing emotional support services for survivors of sexual abuse;

Application Number 1,932,905
Language of Application English

Filing Date 2018-11-28

APPLICANT AND AGENT DETAILS

Applicant

AeroFund Holdings Inc.
6910 Santa Teresa Blvd
San Jose, CA 95119
UNITED STATES OF AMERICA

Agent

CASSELS BROCK & BLACKWELL LLP
SCOTIA PLAZA, SUITE 2100, 40 KING
STREET WEST, TORONTO, ONTARIO,
M5H3C2

TRADEMARK DETAILS

Trademark Type

Design

Visual Representation

The logo for AeroPayExpress features the brand name in a bold, italicized, sans-serif font. A curved line arches over the text, starting under 'Aero' and ending under 'Express'.

Services

Class 36

(1) payment card services; issuing stored value payment cards; financial management of reimbursement payments for others

Class 38

(2) providing electronic transmission of credit card transaction data and electronic payment data via a global computer network

Class 42

(3) providing temporary online access to software for use in managing credit and payments to vendors

Application Number 1,932,953
Language of Application English

Filing Date 2018-11-28

APPLICANT AND AGENT DETAILS

Applicant

ICF International, Inc.
9300 Lee Highway
Fairfax, VA 22031
UNITED STATES OF AMERICA

Agent

BORDEN LADNER GERVAIS LLP
Bay Adelaide Centre, East Tower, 22 Adelaide
St. West, TORONTO, ONTARIO, M5H4E3

TRADEMARK DETAILS

CATALUS

Trademark Type

Standard Characters

Services

Class 35

Advertising services, public relations and marketing services, namely, promoting and marketing the goods and services of others through all public communication means; branding services, namely, consulting and development of brands for businesses; branding services, namely, management and marketing of brands for businesses, namely, developing and managing brand strategies for others; development of marketing strategies and concepts; providing consulting services in the field of facilitating the planning, buying, and selling of print and online advertising space for the goods and services of others; media production services, namely, video and film advertising production; media production services, namely, printing of advertising material for others; providing marketing consultancy in the field of social media, namely, helping clients create and extend their product and brand strategies by creating virally engaging online and print marketing campaigns, and providing social media community management services for the social networking platforms of others; business marketing consulting services, namely, arranging and conducting advertising and promotional campaigns for the products and services of others including preparing advertising campaign budgets, overseeing campaign execution, analyzing, measuring and reporting on advertising campaign success measurements and invoicing and reconciling all marketing campaign expenses; marketing consultation in the field of marketing strategy and program development, namely, developing marketing strategies and concepts for others; creative marketing design services, namely, marketing creative ideation for others, namely, developing ideas and concepts for marketing communications headlines, sub-headlines and visual materials, design and layout of marketing communications using a variety of mediums, namely, print materials, direct mail, e-mail, web pages, social media sites, CD-ROMs, broadcast television and radio, and outdoor billboards, advertising copywriting, production of advertising materials, direct mail advertising services in the nature of letter shop preparation and fulfillment; marketing data management and analytics services, namely, market research; business marketing consulting services in the field of competitive analysis; Business marketing services for others, namely, marketing campaign implementation planning, implementation of customer loyalty programs, corporate and product naming and identity programs, retail systems development, namely, development of in-store point of sale promotions and marketing campaigns designed to increase brand awareness customer acquisition, customer retention and customer's share of purchases

with client through print materials, direct mail, e-mail, web pages, broadcast television and radio, and outdoor billboards; providing marketing services, namely, marketing analysis services, marketing research services, marketing services in the field of evaluating markets for existing goods and services of others, market studies, and market assessment services, to business to consumer industries and business to business industries such as travel, financial services, brick and mortar retailers, online retailers, communication providers, Internet service providers, cable, broadband, satellite service providers, restaurants, health care and fitness, music, entertainment, and package goods industries; new media development services, namely, providing advertising, marketing and promotional services, namely, development of advertising campaigns for others for a variety of mediums, namely, print materials, direct mail, e-mail, web pages, CD-ROMs, broadcast television and radio, and outdoor billboards, advertising, copywriting, production of advertising materials, direct mail advertising services in the nature of letter shop preparation and fulfillment; and business marketing consulting

Claims

Priority Filing Date: November 26, 2018, Country or Office: UNITED STATES OF AMERICA, Application No: 88/205,823 in association with the same kind of services

Application Number 1,933,218
Language of Application English

Filing Date 2018-11-29

APPLICANT AND AGENT DETAILS

Applicant

Fujikura Ltd.
5-1, Kiba 1-chome, Koto-ku
Tokyo, 135-8512
JAPAN

Agent

RIDOUT & MAYBEE LLP
11 Holland Avenue, Suite 601 , Ottawa,
ONTARIO, K1Y4S1

TRADEMARK DETAILS

Trademark Type

Design

Visual Representation



Goods

Class 09

(1) optical fiber cables; optical fiber fusion splicers; electronic cables
(2) downloadable computer software for controlling and operating optical fiber fusion splicers; optical fibers; laser generators, not for medical purposes; electrodes for optical fiber fusion splicers; optical amplifiers; fiber optic connectors; optical connector cleaners, namely hand-held devices for removing contamination, dust and oil from ferrule end faces of optical connectors; optical couplers for optical communications; fiberscopes, not for medical use; electric cable plugs; electronic circuit boards; flexible circuit boards; electric switches in the form of metal dome arrays for mobile phones, personal digital assistants [PDAs], office automation and measurement instruments; membrane switches; pressure sensors; oxygen sensors, not for medical use; electronic connectors for circuit board; connectors for electronic circuits; coaxial cable connectors; flat cable connectors; flat cables; coaxial cables; electric wire harnesses for automobiles; connectors for electric wire harnesses for automobiles; antennas, namely, car antennas, cell phone antennas; film antennas, namely, antennas in the form of electrical circuits functioning as antennas formed on film substrates; heat pipe radiators for optical fiber telecommunications apparatus and telecommunications multiplexers; heat sinks for personal digital assistants [PDAs], computers, and smart phones; electric cables; electric wires

Services

Class 40

manufacture and processing of optical fibers, electric wires and electric cables to the order and specification of others

Application Number 1,933,812
Language of Application English

Filing Date 2018-12-03

APPLICANT AND AGENT DETAILS

Applicant

Carstar Franchisor SPV LLC
440 S. Church Street
Suite 700
Charlotte, NC 28202
UNITED STATES OF AMERICA

Agent

BLAKE, CASSELS & GRAYDON LLP
INTELLECTUAL PROPERTY GROUP, SUITE
4000, COMMERCE COURT WEST, 199 BAY
STREET, TORONTO, ONTARIO, M5L1A9

TRADEMARK DETAILS

EDUCATION DEVELOPMENT GROWTH EXCELLENCE

Trademark Type

Word

Services

Class 35

(1) Franchising services, namely, offering technical and business management assistance in the establishment and operation of motor vehicle repair and maintenance shops; franchising services, namely, business consultation in the establishment and operation of shops dealing in repair and maintenance services in the field of motor vehicles

Class 41

(2) educational services, namely, a business training program for motor vehicle repair and maintenance shop owners

Claims

Priority Filing Date: July 26, 2018, Country or Office: UNITED STATES OF AMERICA, Application No: 88/053751 in association with the same kind of services

Application Number 1,933,825
Language of Application English

Filing Date 2018-12-03

APPLICANT AND AGENT DETAILS

Applicant

Kelli Rae Tamaki
120 - 8th Street South
Suite 200
Lethbridge
ALBERTA
T1J2J3

Agent

NORBERT ALTVATER
(altvater.ca), 2210 Cedar Crescent ,
COALDALE, ALBERTA, T1M0A5

TRADEMARK DETAILS

BUSINESS CAN BE BETTER

Trademark Type

Word

Services

Class 35

(1) Business management and business administration consultancy services for private businesses and owner-managed family businesses. Advice and consultancy relating to the organization and management of business.

Class 41

(2) Educational Services, namely conducting seminars and workshops in the nature of podcasts in the field of business management and financial planning, and distribution of training materials in connection therewith.

Application Number 1,933,845
Language of Application English

Filing Date 2018-12-03

APPLICANT DETAILS

Applicant

Buhd Supply Corp.
9 Conception Bay Hwy
P.O Box 242
Harbour Main
NEWFOUNDLAND AND LABRADOR
A0A2P0

TRADEMARK DETAILS

BUHD

Trademark Type

Word

Goods

Class 18

(1) All-purpose sport bags, all-purpose carrying bags, all-purpose athletic bags; backpacks; luggage tags for travel bags; luggage; wallets; handbags;

Class 21

(2) Housewares, namely mugs, beverage glassware, cabaret trays,

Class 25

(3) Casual clothing; t-shirts, shirts, socks, sweatshirts, hoodies, tank tops, jackets, lab coats, dresses, skirts, sweatpants, pants, and undergarments; headwear namely caps, headbands, ear muffs, hats, and toques; scarves, belts, gloves

Services

Class 43

Coffee house services; café services; coffee and juice bar services; bar and restaurant services; cocktail lounges

Application Number 1,933,859
Language of Application English

Filing Date 2018-12-03

APPLICANT AND AGENT DETAILS

Applicant

Duo Yan Fu shi (Shanghai) Co.,Ltd
Rm.1158, Bldg.A, No.40, Lane 689
Luofen Road, Baoshan District
Shanghai, 201908
CHINA

Agent

WITMART INC.
34 King Street East, Suite 500, Toronto,
ONTARIO, M5C2X8

TRADEMARK DETAILS

SYLVESTIDOSO

Trademark Type

Word

Goods

Class 25

Skirts; Dresses; Coats; Dress suits; Masquerade costumes; Trousers; Evening dresses; Cocktail dresses

Application Number 1,933,991
Language of Application English

Filing Date 2018-12-04

APPLICANT AND AGENT DETAILS

Applicant

Predl GmbH
Matthias-Loi-Strasse 1
04924 Boenitz
GERMANY

Agent

RIDOUT & MAYBEE LLP
250 University Avenue, 5th Floor, Toronto,
ONTARIO, M5H3E5

TRADEMARK DETAILS

Trademark Type

Design

Visual Representation



Colour Claim

Colour is claimed as a feature of the trade-mark. The letters are blue. The line running through the letters is red.

Goods

Class 19

Building materials (not of metal), namely, plastic pipe supports, drainage conduit manhole rings made of precast concrete including a plastic element; building materials made of plastics, namely, drainage conduits; pipes (not of metal) for water and waste water for building purposes; drain pipes (not of metal); manhole base liners (not of metal); manhole covers, namely, manhole base covers (not of metal); pipe connection bells (not of metal); waste water pumping stations (not of metal); infiltration chambers (not of metal) in the nature of storm water retaining chamber; portable buildings (not of metal); monuments not of metal; asphalt, pitch and bitumen

Services

Class 37

Building construction; repair of manholes, sewage channel areas and rising shaft components such as rings and cones; installation services for manholes, sewage channel areas and rising shaft components such as rings and cones; concrete repairs; renovating services relating to discharge conduits; installation of drains, sewer liners, pipes for building purposes, drain pipes, manhole base liners, manhole base covers, pipe connection bells, waste water pumping stations, storm water infiltration chambers, portable buildings, monuments; services for the repair of drains, sewer liners, pipes for building purposes, drain pipes, manhole base liners, manhole base covers, pipe connection bells, waste water pumping stations, storm water infiltration chambers

Application Number 1,934,214
Language of Application English

Filing Date 2018-12-05

APPLICANT AND AGENT DETAILS

Applicant

Borrowell Inc.
33 Yonge Street,
Suite 1301, Toronto
ONTARIO
M5E1G4

Agent

JOHN H. SIMPSON
(SHIFT LAW PROFESSIONAL
CORPORATION), 60 St. Clair Ave. East, Suite
403, Toronto, ONTARIO, M4T1N5

TRADEMARK DETAILS

Trademark Type

Design

Visual Representation



Goods

Class 09

- (1) Electronic newsletters on financial topics.
- (2) Mobile apps, namely, applications for mobile phones and tablet computers for accessing credit scores, credit card balances and loan balances.

Services

Class 36

- (1) Financial services, namely, credit card, loan and consumer credit services.

Class 41

- (2) Providing information and advice on financial topics and financial services, namely on building credit and investing via a website; providing information via an online blog in the field of financial services, namely, on building credit and general information on credit cards, loans and investments.

Application Number 1,934,215
Language of Application English

Filing Date 2018-12-05

APPLICANT AND AGENT DETAILS

Applicant

Borrowell Inc.
33 Yonge Street,
Suite 1301, Toronto
ONTARIO
M5E1G4

Agent

JOHN H. SIMPSON
(SHIFT LAW PROFESSIONAL
CORPORATION), 60 St. Clair Ave. East, Suite
403, Toronto, ONTARIO, M4T1N5

TRADEMARK DETAILS

REFRESH

Trademark Type
Standard Characters

Goods

Class 09

Electronic newsletters on financial topics; mobile apps, namely, applications for mobile phones and tablet computers for accessing credit scores, credit card balances and loan balances.

Services

Class 36

(1) Financial services, namely, credit card, loan and consumer credit services

Class 41

(2) Providing information and advice on financial topics and financial services, namely on building credit and investing via a website; providing information via an online blog in the field of financial services, namely, on building credit and general information on credit cards, loans and investments.

Application Number 1,934,304
Language of Application English

Filing Date 2018-12-05

APPLICANT AND AGENT DETAILS

Applicant

Cervezas Cuauhtémoc Moctezuma, S.A. de C.
V.
Avenida Alfonso Reyes 2202 Norte
Colonia Bella Vista
Monterrey, Nuevo Leon
MEXICO

Agent

RIDOUT & MAYBEE LLP
5500 North Service Road, Suite 101,
Burlington, ONTARIO, L7L6W6

TRADEMARK DETAILS

Trademark Type

Design

Visual Representation



Foreign Character Translation

As provided by the applicant, the English translation is SUN ORIGINAL BEER FROM MEXICO.

Goods

Class 32

Beer

Application Number 1,934,655
Language of Application English

Filing Date 2018-12-07

APPLICANT AND AGENT DETAILS

Applicant

Saegaero International Co., Ltd
3F Jeong-woo B/D
Nambusunhwan-ro, Seocho-gu
P.O. Box 2646
Seoul
REPUBLIC OF KOREA

Agent

THEO YATES
(Yates IP), 17 Bellwood Avenue, Ottawa,
ONTARIO, K1S1S6

TRADEMARK DETAILS

REBODY

Trademark Type

Word

Goods

Class 25

Clothing, namely, t-shirts, crop tops, tank tops, tops as clothing, namely bikini tops, knitted tops, sweat tops, tracksuit tops, hats, camis, caps being headwear, sweaters, hoodies, leggings, jackets, bandanas, beanies, coats, scarves, socks, sun visors being headwear, sleepwear, sweat bands, head bands, sweat pants, sweatshirts, swimwear, footwear, namely shoes, boots, sandals, clogs, shorts, pants, sports bra, bottoms as clothing, namely, bikini bottoms, tracksuit bottoms, underwear, windbreakers

Application Number 1,934,656
Language of Application English

Filing Date 2018-12-07

APPLICANT AND AGENT DETAILS

Applicant

Saegaero International Co., Ltd
3F Jeong-woo B/D
Nambusunhwan-ro, Seocho-gu,
P.O. Box 2646
Seoul
REPUBLIC OF KOREA

Agent

THEO YATES
(Yates IP), 17 Bellwood Avenue, Ottawa,
ONTARIO, K1S1S6

TRADEMARK DETAILS

Trademark Type

Design

Visual Representation



Goods

Class 25

Clothing, namely, t-shirts, crop tops, tank tops, tops as clothing, namely bikini tops, knitted tops, sweat tops, tracksuit tops, hats, camis, caps being headwear, sweaters, hoodies, leggings, jackets, bandanas, beanies, coats, scarves, socks, sun visors being headwear, sleepwear, sweat bands, head bands, sweat pants, sweatshirts, swimwear, footwear, namely shoes, boots, sandals, clogs, shorts, pants, sports bra, bottoms as clothing, namely, bikini bottoms, tracksuit bottoms, underwear, windbreakers

Application Number 1,935,408
Language of Application English

Filing Date 2018-12-11

APPLICANT AND AGENT DETAILS

Applicant

Hangzhou Hikvision Digital Technology Co.,
Ltd.
No. 555 Qianmo Road
Binjiang District
310051
Hangzhou
CHINA

Agent

BERESKIN & PARR LLP/S.E.N.C.R.L., S.R.L.
SCOTIA PLAZA, 40 KING STREET WEST,
40th FLOOR, TORONTO, ONTARIO, M5H3Y2

TRADEMARK DETAILS

SEE FAR, GO FURTHER

Trademark Type

Word

Goods

Class 09

Data processing apparatus, namely, computer hardware for data processing; computer memory hardware; recorded computer operating programs; computer peripheral devices, namely, computer keyboards, computer mouse, microphones, computer speakers, headsets, earphones, trackball input devices, touchpads for computers, light pens; recorded computer software for viewing, recording, managing, accessing, and storing videos, photos and for controlling cameras in the field of video security and premises surveillance for home and commercial buildings; microprocessors; computer monitors; central processing units (CPU); blank integrated circuit cards; downloadable computer programs for viewing, recording, managing, accessing, and storing videos and photos and controlling cameras in the field of video security and premises surveillance for home and commercial buildings; data processing equipment, namely, smart card readers; video surveillance systems, namely, network video recording software for IP (internet protocol) video surveillance; measuring instruments, namely, sensors for measuring distance, pressure, weight, and movement; electronic notice board; electronic bulletin boards, namely, electronic notice boards; luminous or mechanical signal panels, namely, electric luminescent display panels; luminous or mechanical road signs; intercommunication apparatus, namely, two-way radios for transmitting and receiving sound; video telephones; network communications equipment, namely, computer network hubs; radios; radars, radar transmitters, radar receivers; electro-dynamic apparatus for the remote control of signals, namely, computer hardware and recorded software; navigation apparatus for vehicles in the form of on-board computers; video recorders; camcorders; audio and video receivers; cameras; laser speed detectors; flash lamps for cameras; detectors, namely, smog detectors, and human body infrared detectors; speed measuring apparatus for vehicles, namely, speedometers; optical lenses; power wires and power cables; semiconductors; remote control cameras, namely, network video cameras, web cameras, network video recorder and sensors for measuring distance, pressure, weight, and movement and web video recorder and sensors for measuring distance, pressure, weight, and movement to gather, collect and record information of voice frequency and video frequency; video surveillance systems for personal use against

accidents, namely, network video cameras, web cameras, network video recorders and sensors for measuring distance, pressure, weight, and movement and web video recorder and sensors for measuring distance, pressure, weight, and movement; theft alarms; fire alarms; smoke detectors; anti-intrusion alarms, burglar alarms, personal security alarms; burglar alarm systems; anti-theft alarming apparatus, namely, burglar alarms; eyeglasses; electric storage batteries; electric batteries for vehicles; video disks and video tapes with recorded animated cartoons; humanoid robots with artificial intelligence; security surveillance robots; parking meters; automated teller machines; facial recognition software; work attendance checking device, namely, computer software for monitoring work attendance and hardware for attendance machines; attendance machine, namely, electronic sensors in the nature of a turnstile counter for entrances for monitoring attendance at events; machines for check work attendance, namely, fingerprint attendance machine; hologram films; Wafers for integrated circuits; integrated circuit chips for digital video compression and decompression and encoding and decoding digital video; lightning conductors; fire extinguishers; portable remote control car arresters in the nature of electronic locks and electronic key fobs

Services

Class 42

Conducting technical project studies, namely, technical research in the fields of video, surveillance, security, and software for security and premises surveillance for home and commercial buildings; development of new products for others; technical surveying; industrial design; interior design and decoration; consultancy in the field of computer hardware design and development; conversion of data or documents from physical to electronic media; remote monitoring of computer system, namely, monitoring of computer systems by remote access to ensure proper functioning; Electronic data storage, namely, providing cloud storage facilities for use as a data center for others; Technical support services, namely, remote and on-site data centre infrastructure management services in the fields of video, surveillance, security, and software for security and premises surveillance for home and commercial buildings; Providing temporary use of on-line non-downloadable computer software used for running cloud computing based applications; consultancy in the design and development of computer hardware; providing non-downloadable computer programs for video surveillance and for viewing, recording, managing, accessing, and storing videos and photos and controlling cameras on data networks through cloud computing; Cloud computing providing software for database management, cloud computing provider services for general storage of data; Providing virtual computer systems and virtual computer environments through cloud computing; Platform as a service (PaaS) featuring computer software platforms for viewing, recording, managing, accessing, and storing videos and photos and for controlling cameras in the field of video security and premises surveillance for home and commercial buildings; Software as a service services featuring computer software for viewing, recording, managing, accessing, and storing videos and photos and for controlling cameras in the field of video security and premises surveillance for home and commercial buildings

Claims

Priority Filing Date: November 14, 2018, Country or Office: UNITED STATES OF AMERICA, Application No: 88/193,577 in association with the same kind of goods and in association with the same kind of services

Application Number 1,935,442
Language of Application English

Filing Date 2018-12-11

APPLICANT AND AGENT DETAILS

Applicant

9360-8065 QUÉBEC INC.
12300 Rue De l'Avenir
Mirabel
QUÉBEC
J7J2K4

Agent

CANYON IP INC.
1050 Côte du Beaver Hall, bureau 1540,
Montréal, QUÉBEC, H2Z0A5

TRADEMARK DETAILS

WACHSEN

Trademark Type

Word

Foreign Character Translation

As provided by the applicant, the French translation of the German word WACHSEN is CROÎTRE.

Goods

Class 06

- (1) Supports d'horticulture en métal pour le séchage de semis et de plantes.
- (1) Horticultural racks made of metal for drying seedlings and plants

Class 12

- (2) Horticultural carts for drying seedlings and plants

Class 20

- (3) Supports d'horticulture en plastique pour le séchage de semis et de plantes; tablettes d'horticulture pour le séchage de semis et de plantes.

Application Number 1,935,446
Language of Application English

Filing Date 2018-12-11

APPLICANT AND AGENT DETAILS

Applicant

L-Nutra, Inc.
5905 Legacy Drive, 5th Floor
Plano, Texas 75024
UNITED STATES OF AMERICA

Agent

BORDEN LADNER GERVAIS LLP
World Exchange Plaza, 100 Queen Street,
Suite 1300, Ottawa, ONTARIO, K1P1J9

TRADEMARK DETAILS

FMD

Trademark Type

Standard Characters

Goods

Class 05

Dietary supplements for promoting general health and well-being during fasting and for promoting longevity; nutritional supplement energy bars for promoting general health and well-being during fasting and for promoting longevity; nutritionally balanced prepared meals, namely, soups adapted for medical use namely for promoting general health and well-being during fasting; nutritional meal replacement drinks, soups and snacks adapted for medical use namely for promoting general health and well-being during fasting; herbal teas for medical treatments, namely for promoting general health and well-being during fasting; food supplements for promoting general health and well-being during fasting and for promoting longevity; nutritional supplements for promoting general health and well-being during fasting and for promoting longevity; vitamin and mineral supplements; plant-based supplements, namely, herbal supplements, food supplements and mineral nutritional supplements, all for promoting general health and well-being during fasting and for promoting longevity; plant-based supplements, namely, herbal supplements, food supplements and mineral nutritional supplements, all containing algal oil, vegetable powders, and vitamins and minerals

Services

Class 44

Dietary and nutritional guidance; Providing information about dietary supplements and nutrition; Nutrition, dietary and food nutrition counseling; Food nutrition consultation

Application Number 1,935,453
Language of Application English

Filing Date 2018-12-11

APPLICANT AND AGENT DETAILS

Applicant

DOMUS VITA INC.
320 Painted Post Dr, Suite D
Scarborough
ONTARIO
M1G2M3

Agent

METHOD LAW PROFESSIONAL
CORPORATION
4211 Yonge Street, Suite 310, Toronto,
ONTARIO, M2P2A9

TRADEMARK DETAILS

Trademark Type

Design

Visual Representation

The logo for SOFAITALIA features the word "SOFA" in orange and "ITALIA" in red, both in a bold, sans-serif font. Below this, the tagline "LUXURY REIMAGINED" is written in a smaller, red, sans-serif font.

Colour Claim

Colour is claimed as a feature of the trademark. The word SOFA is orange and the words ITALIA LUXURY REIMAGINED are red.

Goods

Class 20

(1) Sofa beds; sofa loungers; sleeper sofas; sofas; pullout beds; futons; beds; furniture, namely, bedroom furniture, dining room furniture, living room furniture, outdoor furniture; mattresses; mattress accessories, namely, mattress toppers; box springs; bedding accessories, namely, pillows.

Class 24

(2) Furnishings, namely, furnishing fabrics; upholstery, namely, upholstery fabrics; mattress accessories, namely, mattress covers; bedding accessories, namely, bed sheets, bed throws, pillow cases, pillow covers.

Services

Class 35

(1) Retail and online store services for sofa beds, sofa loungers, sleeper sofas, sofas, pullout beds, futons, beds, furniture, furnishings, upholstery, mattresses, mattress accessories, box springs and bedding accessories.

Class 37

(2) Set up services, namely installation of sofa beds, sofa loungers, sleeper sofas, sofas, pullout beds, futons, beds, furniture, mattresses and box springs.

Class 39

(3) Delivery of sofa beds, sofa loungers, sleeper sofas, sofas, pullout beds, futons, beds, furniture, furnishings, upholstery, mattresses, mattress accessories, box springs and bedding accessories.

Application Number 1,935,496
Language of Application English

Filing Date 2018-12-12

APPLICANT AND AGENT DETAILS

Applicant

BAIDU ONLINE NETWORK TECHNOLOGY
(BEIJING) CO., LTD.
BAIDU CAMPUS, NO. 10, SHANGDI 10TH
STREET, HAIDIAN DISTRICT, BEIJING,
100085
CHINA

Agent

BORDEN LADNER GERVAIS LLP
World Exchange Plaza, 100 Queen Street,
Suite 1300, Ottawa, ONTARIO, K1P1J9

TRADEMARK DETAILS

VisualDL

Trademark Type

Standard Characters

Goods

Class 09

Computer software libraries for use in general purpose computation, manipulation of collections of data, data transformation, BIOS [basic input/output systems], communications, graphics display, modeling and testing namely creating computer simulations for use in the fields of artificial intelligence, deep learning, high performance computing, distributed computing, computer virtualization and machine learning; Computer software runtime systems, namely, systems comprised of computer software libraries for use in general purpose computation, manipulation of collections of data, data transformation, BIOS [basic input/output systems], communications, graphics display, modeling and testing namely creating computer simulations for use in the fields of artificial intelligence, deep learning, high performance computing, distributed computing, computer virtualization and machine learning; Computer software, computer software platforms, computer application software and downloadable computer software for implementing a computer programming language, and computer software development tools for use in the fields of artificial intelligence, deep learning, high performance computing, distributed computing, computer virtualization and machine learning; application programming interface (api) software for gathering market data for use in the fields of artificial intelligence, deep learning, high performance computing, distributed computing, computer virtualization and machine learning; application programming interface (api) software for analyzing market data for use in the fields of artificial intelligence, deep learning, high performance computing, distributed computing, computer virtualization and machine learning; Downloadable electronic publications in the nature of electronic magazines, electronic periodicals, electronic books, electronic newsletters in the field of artificial intelligence, deep learning, high performance computing, distributed computing, computer virtualization and machine learning; Downloadable computer graphics in the field of artificial intelligence, deep learning, high performance computing, distributed computing, computer virtualization and machine learning; Computer software for creating and managing searchable databases in the field of artificial intelligence, deep learning, high performance computing, distributed computing, computer virtualization and machine learning; Computer software for assisting developers in creating program code for use in multiple application programs; Computer

software for running development programs and application programs in a common development environment; Computer software for use in providing multiple user access to a global computer information network; Computer software for controlling and managing access server applications; Computer software for global positioning systems; Computer software for use in creating and designing web sites; Computer operating programs; Computer operating system software.

Services

Class 42

Providing non-downloadable computer software libraries for use in general purpose computation, manipulation of collections of data, data transformation, BIOS [basic input/output systems], communications, graphics display, modeling and testing namely creating computer simulations for use in the fields of artificial intelligence, deep learning, high performance computing, distributed computing, computer virtualization and machine learning; Providing non-downloadable computer software, namely, runtime systems comprised of computer software libraries for use in general purpose computation, manipulation of collections of data, data transformation, BIOS [basic input/output systems], communications, graphics display, modeling and testing namely creating computer simulations for use in the fields of artificial intelligence, deep learning, high performance computing, distributed computing, computer virtualization and machine learning; Providing on-line non-downloadable application programming interface (api) software for gathering market data for use in the fields of artificial intelligence, deep learning, high performance computing, distributed computing, computer virtualization and machine learning; Providing on-line non-downloadable application programming interface (api) software for analyzing market data for use in the fields of artificial intelligence, deep learning, high performance computing, distributed computing, computer virtualization and machine learning; Providing information on computer technology and programming via a web site, namely, in relation to non-downloadable computer software, namely, runtime systems comprised of computer software libraries for use in general purpose computation, manipulation of collections of data, data transformation, BIOS [basic input/output systems], communications, graphics display, modeling and testing namely creating computer simulations for use in the fields of artificial intelligence, deep learning, high performance computing, distributed computing, computer virtualization and machine learning; Computer software design and updating in relation to non-downloadable computer software, namely, runtime systems comprised of computer software libraries for use in general purpose computation, manipulation of collections of data, data transformation, BIOS [basic input/output systems], communications, graphics display, modeling and testing namely creating computer simulations for use in the fields of artificial intelligence, deep learning, high performance computing, distributed computing, computer virtualization and machine learning; Computer software design and updating in the field of artificial intelligence, deep learning, high performance computing, distributed computing, computer virtualization and machine learning; Software as a service (SAAS) provider in the field of non-downloadable computer software, namely, runtime systems comprised of computer software libraries for use in general purpose computation, manipulation of collections of data, data transformation, BIOS [basic input/output systems], communications, graphics display, modeling and testing namely creating computer simulations for use in the fields of artificial intelligence, deep learning, high performance computing, distributed computing, computer virtualization and machine learning; Platform as a service (PAAS) provider in the field of non-downloadable computer software, namely, runtime systems comprised of computer software libraries for use in general purpose computation, manipulation of collections of data, data transformation, BIOS [basic input/output systems], communications, graphics display, modeling and testing namely creating computer simulations for use in the fields of artificial intelligence, deep learning, high performance computing, distributed computing, computer virtualization and machine learning; Cloud computing

featuring application programming interface (api) software for gathering market data for use in the fields of artificial intelligence, deep learning, high performance computing, distributed computing, computer virtualization and machine learning; Cloud computing featuring application programming interface (api) software for analyzing market data for use in the fields of artificial intelligence, deep learning, high performance computing, distributed computing, computer virtualization and machine learning ; Providing search engines for the internet in the field of artificial intelligence, deep learning, high performance computing, distributed computing, computer virtualization and machine learning; Conversion of data or documents from physical to electronic media; Data encryption and decoding services; Electronic storage of photographic images; Research and development of new products for others; Computer system design; Computer programming consultancy.

Application Number 1,935,577
Language of Application English

Filing Date 2018-12-12

APPLICANT AND AGENT DETAILS

Applicant

TRANSCHEM INC.
1225 Franklin Blvd.
Cambridge
ONTARIO
N1R7E5

Agent

GOWLING WLG (CANADA) LLP
1 MAIN STREET WEST, HAMILTON,
ONTARIO, L8P4Z5

TRADEMARK DETAILS

CLEAR TECHNOLOGIES

Trademark Type

Word

Goods

Class 11

Waste water reclaim system in the nature of waste water purification apparatus, installations and tanks for the vehicle washing industry, agriculture and potable water solutions

Application Number 1,935,639
Language of Application English

Filing Date 2018-12-12

APPLICANT AND AGENT DETAILS

Applicant

BIMBA MANUFACTURING COMPANY
25150 South Governors Highway
University Park, IL 60484
UNITED STATES OF AMERICA

Agent

MACRAE & CO.
326 Somerset Street West, Ottawa, ONTARIO,
K2P0J9

TRADEMARK DETAILS

BIMBA

Trademark Type

Word

Goods

Class 07

(1) Valves being parts of machines; valves being parts of pumps; valves for industrial machinery; valves for pumps; valves as machine components; control valves for regulating the flow of gases and liquids; automatic inlet control valves for reciprocating air compressors; pneumatic valves being parts of machines; hydraulic valves being parts of machines; check valves; actuators for valves, namely, hydraulic and pneumatic actuators; hydraulic linear actuators, other than for land vehicles; pneumatic linear actuators, other than for land vehicles; pneumatic rotary actuators being parts of machines; pneumatically and hydraulically controlled devices being grippers for use in pneumatic and hydraulic devices for the purposes of picking up and placing objects, transferring material, clamping objects, and indexing objects; vacuum robotics and tools, namely, vacuum cups and reciprocating vacuum pumps as parts of machines; vacuum pumps; pumps namely, compressed air pumps, hydraulic pumps, lubricating pumps; pneumatic fluid filters being parts of pneumatic or hydraulic machines; air filters being parts of pneumatic or hydraulic machines; filters for cleaning air, being parts of pneumatic or hydraulic machines; Lubricators for lubricating pneumatic or hydraulic machines; pressure switches being parts of machines for monitoring, controlling and switching pneumatic or hydraulic systems; positioners in the nature of pneumatic and hydraulic controller devices for controlling movement of automated production machinery; miniature pneumatic components, namely, pneumatic manifolds; silencers, mufflers and noise reduction devices for machines and parts of machines; cylinders for machines; cylinders for industrial machinery; pressure regulating valves being parts of machines; air compressors; pistons for cylinders; air preparation devices, namely, pneumatic filters, regulators, lubricators, and parts thereof for use in pneumatic machinery for conditioning compressed air; pneumatic tubing accessories, namely accessories for tubes used in machines to convey material via compressed air or vacuum; pneumatic tubing namely tubes used in machines to convey material via compressed air or vacuum; safety valves; replacement parts for all the following: valves being parts of machines, valves being parts of pumps, valves for industrial machinery, valves for pumps, valves as machine components, control valves for regulating the flow of gases and liquids, automatic inlet control valves for reciprocating air compressors, pneumatic valves being parts of machines, hydraulic valves being parts of machine, check valves, actuators for valves, namely, hydraulic and pneumatic actuators, hydraulic linear actuators, other than for land vehicles,

pneumatic linear actuators, other than for land vehicles, pneumatic rotary actuators being parts of machines, Pneumatically and hydraulically controlled devices being grippers for use in pneumatic and hydraulic devices for the purposes of picking up and placing objects, transferring material, clamping objects, and indexing objects, vacuums robotics and tools, namely, vacuum cups and reciprocating vacuum pumps as parts of machines, vacuum pumps, pumps namely, compressed air pumps, hydraulic pumps, lubricating pumps, pneumatic fluid filters being parts of pneumatic or hydraulic machines, air filters being parts of pneumatic or hydraulic machines, filters for cleaning air, being parts of pneumatic or hydraulic machines, Lubricators for lubricating pneumatic or hydraulic machines, pressure switches being parts of machines for monitoring, controlling and switching pneumatic or hydraulic system, positioners in the nature of pneumatic and hydraulic controller devices for controlling movement of automated production machinery, miniature pneumatic components, namely, pneumatic manifolds, silencers, mufflers and noise reduction devices for machines and parts of machines, cylinders for machines, cylinders for industrial machinery, pressure regulating valves being parts of machines, air compressors, pistons for cylinders, air preparation devices, namely, pneumatic filters, regulators, lubricators, and parts thereof for use in pneumatic machinery for conditioning compressed air, pneumatic tubing accessories, namely, accessories for tubes used in machines to convey material via compressed air or vacuum, pneumatic tubing namely tubes used in machines to convey material via compressed air or vacuum, and safety valves

Class 09

(2) Valves for controlling and regulating the flow of gases and liquids; manual/mechanical valves; pneumatically operated valves; time delay control valves; solenoid valves; valve manifolds for control systems; control valve mounting manifolds; electric actuators; automatic time switches; automatic transfer switches; current switches; cut-out switches; differential switches; diode AC switches; diode alternating current switches; electric current switches; electric flasher switches; electric rotary switches; electric tactile switches; electric toggle switches; electromagnetic switches; electronic motion sensitive switches; fault current switches; mercury switches; power switches; pressure switches; rocker switches; smart tactile switches; time switches; timer switches; touch sensitive switches; downloadable software for machine control; software for managing fluid powered systems and machines involved in factory automation; electronic control apparatus and instruments for controlling pneumatic and hydraulic systems in the nature of pneumatic and hydraulic machines; temperature sensors for managing fluid power systems and machines involved in factory automation; pressure sensors for managing fluid power systems and machines involved in factory automation; vacuum sensors for managing fluid power systems and machines involved in factory automation; electronic positioners for use with machines; Flow controls for fluid handling machines and equipment in the nature of automatic liquid flow control machines; cylinders being automatic liquid-flow control machines; regulators and flow rate and pressure indicators in the nature of pressure gauges, pressure indicators and measuring apparatus for the production, processing or treatment of compressed air or other compressed gases; flow gauges; replacement parts for all the following: Valves for controlling and regulating the flow of gases and liquids, manual/mechanical valves, pneumatically operated valves, time delay control valves, solenoid valves, valve manifolds for control systems, control valve mounting manifolds, electric actuators, automatic time switches, automatic transfer switches, current switches, cut-out switches, differential switches, diode AC switches, diode alternating current switches, electric current switches, electric flasher switches, electric rotary switches, electric tactile switches, electric toggle switches, electromagnetic switches, electronic motion sensitive switches, fault current switches, mercury switches, power switches, pressure switches, rocker switches, smart tactile switches, time switches, timer switches, touch sensitive switches, downloadable software for

machine control, software for managing fluid powered systems and machines involved in factory automation, electronic control apparatus and instruments for controlling pneumatic and hydraulic systems in the nature of pneumatic and hydraulic machines, temperature sensors for managing fluid power systems and machines involved in factory automation, pressure sensors for managing fluid power systems and machines involved in factory automation, vacuum sensors for managing fluid power systems and machines involved in factory automation, electronic positioners for use with machines, digital positioners for use with machines, Flow controls for fluid handling machines and equipment in the nature of automatic liquid flow control machines, cylinders being automatic liquid-flow control machines, pressure regulators and flow rate and pressure indicators in the nature of pressure gauges, pressure indicators and measuring apparatus for the production, processing or treatment of compressed air or other compressed gases, and flow gauges

Claims

Priority Filing Date: December 10, 2018, Country or Office: UNITED STATES OF AMERICA, Application No: 88/223,670 in association with the same kind of goods

Application Number 1,935,699
Language of Application English

Filing Date 2018-12-12

APPLICANT AND AGENT DETAILS

Applicant

FBSciences Holdings, Inc.
153 N. Main Street
Suite 100
Collierville , TN 38017
UNITED STATES OF AMERICA

Agent

GOWLING WLG (CANADA) LLP
SUITE 1600, 1 FIRST CANADIAN PLACE, 100
KING STREET WEST, TORONTO, ONTARIO,
M5X1G5

TRADEMARK DETAILS

FBS DEFENSE

Trademark Type

Standard Characters

Goods

Class 01

- (1) Naturally derived adjuvants and surfactants to improve the efficiency of pesticides and biopesticides
- (2) plant growth regulators for agricultural use;

Class 05

- (3) chemical preparations to improve efficiency of pesticides and bio pesticides
- (4) agricultural biopesticides; fungicides; herbicides; insecticides; nematicides; pesticides;

Claims

Priority Filing Date: November 14, 2018, Country or Office: UNITED STATES OF AMERICA,
Application No: 88194250 in association with the same kind of goods

Application Number 1,935,848
Language of Application English

Filing Date 2018-12-13

APPLICANT AND AGENT DETAILS

Applicant

COLIO ESTATE WINES INC.
5900 Ambler Drive Unit 7
Mississauga
ONTARIO
L4W2N3

Agent

JENNIFER MCKAY
(Dentons Canada LLP), 99 Bank Street, Suite
1420, Ottawa, ONTARIO, K1P1H4

TRADEMARK DETAILS

Trademark Type

Design

Visual Representation



Goods

Class 06

(1) casks of metal; kegs of metal; metal kegs;

Class 16

(2) coasters;

Class 20

(3) casks, not of metal;

Class 21

(4) bottle openers; drinking glasses; corkscrews; ice buckets; glass coasters; plastic coasters;

Class 25

(5) hats; T-shirts; jackets; ball caps; aprons;

Class 32

(6) beer; lager; ale; stout

Application Number 1,936,106
Language of Application English

Filing Date 2018-12-14

APPLICANT AND AGENT DETAILS

Applicant

Gluttons & Drunkards Clothing Company Inc.
9 Logan St
Paradise
NEWFOUNDLAND AND LABRADOR
A1L0H5

Agent

ERIN BEST
(STEWART MCKELVEY), SUITE 1100,
CABOT PLACE, 100 NEW GOWER STREET,
P.O. BOX 5038, ST. JOHN'S,
NEWFOUNDLAND AND LABRADOR, A1C5V3

TRADEMARK DETAILS

GLUTTONS & DRUNKARDS

Trademark Type

Word

Goods

Class 25

Clothing, namely aprons, casual clothing, hats, sweatpants, sweatshirts, and t-shirts.

Application Number 1,936,111
Language of Application English

Filing Date 2018-12-14

APPLICANT AND AGENT DETAILS

Applicant

Bentley Systems, Incorporated
685 Stockton Drive
Exton, PA 19341
UNITED STATES OF AMERICA

Agent

SMART & BIGGAR LLP
SUITE 900, 55 METCALFE STREET, P.O.
BOX 2999, STATION D, OTTAWA, ONTARIO,
K1P5Y6

TRADEMARK DETAILS

ASSETWISE

Trademark Type

Word

Goods

Class 09

Computer software for managing infrastructure and industrial assets, namely, for database management of databases describing buildings, factories, power plants, refineries, roads, railways, bridges, mines, utility and telecommunications networks, and industrial machinery; Computer software for maintaining, organizing, analyzing and visualizing infrastructure and industrial asset data, namely, data stored in databases and data warehouses, for use in the fields of civil engineering, operations management and industrial machinery maintenance; Computer software for managing inspection, maintenance and repair of infrastructure and industrial assets, namely, for managing inspection, maintenance and repair of buildings, factories, power plants, refineries, roads, railways, bridges, mines, utility and telecommunications networks and industrial machinery; Computer software for database management in the field of industrial Internet of Things enabled machinery

Services

Class 42

Cloud computing providing software for managing infrastructure and industrial assets, namely, cloud computing software for database management of databases describing buildings, factories, power plants, refineries, roads, railways, bridges, mines, utility and telecommunications networks and industrial equipment; providing temporary use of non-downloadable computer software for collecting, organizing, synchronizing, analyzing and visualizing infrastructure and industrial asset data, namely, data stored in databases and data warehouses, for use in the fields of civil engineering, operations management and industrial machinery maintenance

Claims

Priority Filing Date: June 25, 2018, Country or Office: UNITED STATES OF AMERICA, Application No: 88/014,289 in association with the same kind of goods and in association with the same kind of services

Application Number 1,936,112
Language of Application English

Filing Date 2018-12-14

APPLICANT AND AGENT DETAILS

Applicant

DePuy Synthes, Inc.
700 Orthopaedic Drive
Warsaw, IN 46582
UNITED STATES OF AMERICA

Agent

BERESKIN & PARR LLP/S.E.N.C.R.L., S.R.L.
SCOTIA PLAZA, 40 KING STREET WEST,
40th FLOOR, TORONTO, ONTARIO, M5H3Y2

TRADEMARK DETAILS

MATRIXPRO

Trademark Type

Standard Characters

Goods

Class 10

Medical equipment, namely battery powered surgical drivers and surgical drills for use in neurosurgery and parts and fittings for the aforementioned goods

Application Number 1,936,391
Language of Application English

Filing Date 2018-12-17

APPLICANT AND AGENT DETAILS

Applicant

Frank Csernetics
69-198 Springbank Dr
London
ONTARIO
N6J1G1

Agent

TRADEMARK DEPOT
3772 De La Goudrelle, Saint-Lazare,
QUEBEC, J7T2N1

TRADEMARK DETAILS

Trademark Type

Design

Visual Representation



Goods

Class 21

(1) beer mugs; coffee mugs; cups and mugs; travel mugs

Class 25

(2) baseball caps and hats; shirts

Class 28

(3) Christmas decorations; Christmas ornaments

Application Number 1,936,510
Language of Application English

Filing Date 2018-12-17

APPLICANT AND AGENT DETAILS

Applicant

101 Studios, LLC
10250 Constellation Boulevard, Suite 100
Los Angeles, CA 90067
UNITED STATES OF AMERICA

Agent

MOFFAT & CO.
P.O. Box 2088, Station D, Ottawa, ONTARIO,
K1P5W3

TRADEMARK DETAILS

101 STUDIOS

Trademark Type

Word

Goods

Class 09

Pre-recorded audio and visual recordings and DVDs of movies and television shows on a wide variety of topics; downloadable movies and television shows on a wide variety of topics provided via a video-on-demand service; downloadable movies and television shows in the fields of action adventure, animation, anime, biography, classics, comedy, crime, documentary, drama, faith, family, fantasy, film-noir, history, horror, international, musical, mystery, romance, science fiction, sports, thrillers, war, and westerns; audio recordings featuring music

Services

Class 41

Entertainment services in the nature of the development, production, and distribution of movies and television shows; providing non-downloadable movies and television shows via a video-on-demand transmission service; providing entertainment news, news releases, information and interviews via a website in the field of television programs, movies, music, live theatre, dance, cultural events and sports; publication of books and screenplays; production of audio and audiovisual recordings, namely, television shows, films, movies and podcasts

Claims

Priority Filing Date: June 21, 2018, Country or Office: UNITED STATES OF AMERICA, Application No: 88/010,017 in association with the same kind of services; June 21, 2018, Country or Office: UNITED STATES OF AMERICA, Application No: 88/010,014 in association with the same kind of goods

Application Number 1,936,593
Language of Application English

Filing Date 2018-12-17

APPLICANT AND AGENT DETAILS

Applicant

Aquafortus Technologies Limited
Level 1, 57 Symonds Street, Grafton
Auckland 1010
NEW ZEALAND

Agent

GOWLING WLG (CANADA) LLP
550 BURRARD STREET, SUITE 2300,
VANCOUVER, BRITISH COLUMBIA, V6C2B5

TRADEMARK DETAILS

AQUAFORTUS

Trademark Type

Word

Goods

Class 01

(1) Water purifying chemicals; water treatment preparations (chemical); chemicals for treating water; chemicals for use in purifying water; chemicals for use in the purification of water; chemicals for the purification of water; chemical preparations for use in water purification; chemical preparations for the treatment of water; chemical preparations for use in water treatment; chemicals for use in clarifying water; chemicals for use in cleaning water; chemicals for use in clearing water; chemical additives for use in the cleaning of water; chemicals for use in the purification of solvents; filter aids for liquid purification, namely, chemical preparations for use in water purification and for use in the purification of solvents.

Class 11

(2) Water filters for industrial purposes; filters for drinking water; filters for water purifiers; domestic water filtering units; drinking water filters; industrial waste water purification plants; municipal water purification machines; sterilizers for water treatment; tap-water purifying apparatus; water distillation units; water filtering units for domestic use; water filtering units for industrial use; water purification machines for domestic use; water purifiers for household purposes; water purifiers for industrial purposes; water treatment plant filters; purification installations for sewage; rainwater purification installations; water conditioning units; water distillation units.

Services

Class 40

Treatment of chemical waste; chemical treatment of waste products; chemical recycling of waste products; demineralization of water; water purification; water treating; treatment of waste water; waste water treatment; water treatment services; industrial treatment of effluents, namely, water treatment services; rental of water treatment equipment; waste water reprocessing; waste water treatment services; water and sewer management; water recycling; water treating.

Application Number 1,936,728
Language of Application English

Filing Date 2018-12-18

APPLICANT AND AGENT DETAILS

Applicant

Discord Inc.
444 De Haro Street, Suite 200
San Francisco, CA 94107
UNITED STATES OF AMERICA

Agent

GOWLING WLG (CANADA) LLP
SUITE 1600, 1 FIRST CANADIAN PLACE, 100
KING STREET WEST, TORONTO, ONTARIO,
M5X1G5

TRADEMARK DETAILS

DISCORD

Trademark Type

Word

Goods

Class 09

Downloadable computer software and computer software application for social networking and for sending email messages, text messages, photos, graphics, music, voice and video calls to other users; computer software for engaging in text, audio and video chats with other users; computer software programs for creating virtual communities for registered users to participate in discussions by integrating the ability to share text messages, share personal photos and graphics, share music, voice and video calls through interactive multimedia mobile and web applications

Services

Class 38

Communication services, namely, transmission of data, namely, of digital computer graphics, photos, text messages, electronic mail, personal video message files over global communication networks, the Internet, and wireless networks; message sending and receiving services namely, voice-to-text messaging services; text messaging, voice messaging and video messaging services; providing online chat rooms, online forums, and electronic bulletin boards for transmission of messages among computer and electronic game users

Application Number 1,936,778
Language of Application English

Filing Date 2018-12-18

APPLICANT AND AGENT DETAILS

Applicant

ADVANFIT INC., a Juridical person
incorporated in the Japanese Law
3300, Nagata-machi
Yatsushiro-shi
Kumamoto 866-0815
JAPAN

Agent

ROBIC
630, boul. René-Lévesque Ouest, 20e étage,
Montréal, QUEBEC, H3B1S6

TRADEMARK DETAILS

Trademark Type

Design

Visual Representation

ADVANFIT

Goods

Class 10

Walking sticks for medical purposes; gloves for medical purposes; bracelets for medical purposes; boots for medical purposes, namely orthopedic boots; belts for medical purposes, namely abdominal belts, orthopaedic belts, pelvis correction belt and belts for attaching medical monitors to patients; cushions for medical purposes; air beds for medical purposes; corsets for medical purposes; surgical sponges; compression garments; traction apparatus for medical purposes, namely cervical neck traction medical device and spine traction medical device to relieve pressure and pain; air pillows for medical purposes; air mattresses for medical purposes; hydrostatic beds for medical purposes; hypogastric belts; abdominal corsets; abdominal pads; physical exercise apparatus for medical purposes, namely orthopaedic exercise footwear and electronic heart rate monitors for use during physical exercise; belts, electric, for medical purposes; heating cushions, electric, for medical purposes; arch supports for footwear; body rehabilitation apparatus for medical purposes, namely robotic exoskeleton suits for physical rehabilitation purposes; supporters for medical purposes, namely back supports, medical support tights and stockings, orthopaedic support bandages; physiotherapy apparatus, namely kinesiology tapes for physiotherapy purposes; walking aids for medical purposes, namely walking sticks for medical purposes and wheeled trolleys adapted for use as walking aid apparatus; head supporter for postoperative treatment of cervical spine disease, namely foam head positioners for surgical and medical use; head supporting device for postoperative treatment of cervical spine disease, namely cervical pillows and collars for medical purposes; back supports for medical purposes, namely thoracic lumbar region supporter for spinal compression fracture treatment; orthopedic braces, namely breast lumbar supportive brace for spinal compression fracture treatment; abdominal supporter for sacroiliac joint treatment, namely abdomen support brace for sacroiliac joint treatment; belt shoulder supporter for cuff tear breakage/damage postoperative treatment; belt

shoulder supporting brace for cuff tearing and injury surgery treatment; foot supporter for treatment after Achilles tendon rupture; foot supportive device for treatment after Achilles tendon tear cleft surgery; foot supporter for treatment after calcaneus fracture, namely orthopaedic insoles for the arch of the foot; therapeutic foot support brace after calcaneus fracture; foot affected part supporter suffering from nerve palsy, namely orthopaedic insoles for the arch of the foot, medical support socks, arch supports for footwear, ankle supports for medical use; medical supporter for assisting leg restoration training, namely compression leggings; supporting device for restoring leg functional restraint, namely compression leggings; shoe type supporter for orthopaedic foot correction, namely arch support inserts for shoes and magnetic orthopedic insoles for shoes; posts and knee joints of supporting orthosis for walking training during leg diseases, namely knee support braces.

Application Number 1,936,784
Language of Application English

Filing Date 2018-12-18

APPLICANT AND AGENT DETAILS

Applicant

ADVANFIT INC., a Juridical person
incorporated in the Japanese Law
3300, Nagata-machi
Yatsushiro-shi
Kumamoto 866-0815
JAPAN

Agent

ROBIC
630, boul. René-Lévesque Ouest, 20e étage,
Montréal, QUEBEC, H3B1S6

TRADEMARK DETAILS

Trademark Type

Design

Visual Representation



Goods

Class 10

Walking sticks for medical purposes; gloves for medical purposes; bracelets for medical purposes; boots for medical purposes, namely orthopedic boots; belts for medical purposes, namely abdominal belts, orthopaedic belts, pelvis correction belt and belts for attaching medical monitors to patients; cushions for medical purposes; air beds for medical purposes; corsets for medical purposes; surgical sponges; compression garments; traction apparatus for medical purposes, namely cervical neck traction medical device and spine traction medical device to relieve pressure and pain; air pillows for medical purposes; air mattresses for medical purposes; hydrostatic beds for medical purposes; hypogastric belts; abdominal corsets; abdominal pads; physical exercise apparatus for medical purposes, namely orthopaedic exercise footwear and electronic heart rate monitors for use during physical exercise; belts, electric, for medical purposes; heating cushions, electric, for medical purposes; arch supports for footwear; body rehabilitation apparatus for medical purposes, namely robotic exoskeleton suits for physical rehabilitation purposes; supporters for medical purposes, namely back supports, medical support tights and stockings,

orthopaedic support bandages; physiotherapy apparatus, namely kinesiology tapes for physiotherapy purposes; walking aids for medical purposes, namely walking sticks for medical purposes and wheeled trolleys adapted for use as walking aid apparatus; head supporter for postoperative treatment of cervical spine disease, namely foam head positioners for surgical and medical use; head supporting device for postoperative treatment of cervical spine disease, namely cervical pillows and collars for medical purposes; back supports for medical purposes, namely thoracic lumbar region supporter for spinal compression fracture treatment; orthopedic braces, namely breast lumbar supportive brace for spinal compression fracture treatment; abdominal supporter for sacroiliac joint treatment, namely abdomen support brace for sacroiliac joint treatment; belt shoulder supporter for cuff tear breakage/damage postoperative treatment; belt shoulder supporting brace for cuff tearing and injury surgery treatment; foot supporter for treatment after Achilles tendon rupture; foot supportive device for treatment after Achilles tendon tear cleft surgery; foot supporter for treatment after calcaneus fracture, namely orthopaedic insoles for the arch of the foot; therapeutic foot support brace after calcaneus fracture; foot affected part supporter suffering from nerve palsy, namely orthopaedic insoles for the arch of the foot, medical support socks, arch supports for footwear, ankle supports for medical use; medical supporter for assisting leg restoration training, namely compression leggings; supporting device for restoring leg functional restraint, namely compression leggings; shoe type supporter for orthopaedic foot correction, namely arch support inserts for shoes and magnetic orthopedic insoles for shoes; posts and knee joints of supporting orthosis for walking training during leg diseases, namely knee support braces.

Application Number 1,936,803
Language of Application English

Filing Date 2018-12-18

APPLICANT AND AGENT DETAILS

Applicant

Adris Pty Ltd
6 Burleigh Street
Toronto New South Wales 2283
AUSTRALIA

Agent

PARLEE MCLAWS LLP
1700 Enbridge Centre, 10175-101 Street NW,
EDMONTON, ALBERTA, T5J0H3

TRADEMARK DETAILS

Trademark Type

Design

Visual Representation



Goods

Class 07

Aerating pumps, namely, aerating pumps for use submerged in ponds to aerate and circulate water; pumps as parts of air compressors; air pumps for garage installations; axial flow pumps; beer pumps; bilge pumps; centrifugal pumps; centrifugal water pumps for domestic purposes; circulating pumps; compressed air pumps; computer controlled fuel dispensing pumps for service stations; concrete pumps; controlled rate release diaphragm pumps for delivering pre-measured quantities, not for medical use; diaphragm pumps; diaphragm pumps for pumping fluid material; diaphragm pumps for pumping liquid material; diaphragm pumps for pumping semi-liquid material; diaphragm pumps for use in the metering of fluids; distribution pumps, namely, electric pumps for industrial purposes, pneumatic pumps, diaphragm pumps, submersible pumps, centrifugal pumps, shoe pumps; dosing machines, namely, metering pumps; electric centrifugal pumps, electric positive displacement pumps; engine driven diaphragm and centrifugal pumps for pumping water; engine fuel pumps; electric centrifugal feed pumps, electric positive displacement feed pumps, and pneumatic feed pumps; electric centrifugal fluid elevations pumps, electric positive displacement fluid elevation pumps, and pneumatic fluid elevation pumps; fluid flow control devices, namely, electric centrifugal pumps, electric positive displacement pumps and pneumatic pumps; fluid pumps, namely, electric centrifugal pumps, electric positive displacement pumps, hydraulic pumps, pneumatic pumps; fuel dispensing pumps for service stations for filling fuel tanks, fuel drums, and fuel containers; heat pumps as parts of machines; high pressure rotary positive displacement pumps; hydraulic pumps; jet pumps for vacuum generation; selfregulating liquid fuel supply pumps; lubricating pumps; lubrication pumps; pump casings as machine components; marine pumps, namely, aquarium pumps in the nature of bilge pumps, waste pumps, fish transfer pumps, and ballast pumps; metering pumps for dispensing substances in measured quantities, not for medical

use; pneumatic and electric diaphragm pumps; pumps as parts of motors; motorised pumps, namely, electric centrifugal pumps, electric positive displacement pumps and pneumatic pumps; petrol pumps for service stations; pneumatic conveying pumps; pneumatic pumps; pumps for industrial machinery; pumps as parts of engines; electric drum pumps for containers; pumps as parts of machines for ink feeding; machine pumps for dispensing liquid fuels for use in filling stations; self-regulating pumps for dispensing liquid fuels for use in filling stations; pumps as parts of machines; pumps for recycling water in swimming pools; electric and pneumatic pumps as machines for the extraction of gases; electric and pneumatic pumps as machines for the extraction of liquids; electric and pneumatic pumps as machines for the extraction of vapour; electric and pneumatic pumps as machines for use in irrigation systems in agriculture; electric and pneumatic pumps as machines for use in irrigation systems in horticulture; pumps for use in service stations in dispensing liquid fuels; electric and pneumatic pumps as machines for use in the food industry; rotary gear pumps; rotary pumps; screw pumps; self-priming centrifugal pumps; shower pumps; submersible electric pumps; submersible pumps; sump pumps; vacuum pumps; volumetric rotating gear pumps, namely, controlled volume pumps; water pumps for use as water removal apparatuses for swimming pools, dams; water pumps for use as water supply machines for swimming pools, dams

Application Number 1,937,010
Language of Application English

Filing Date 2018-12-19

APPLICANT AND AGENT DETAILS

Applicant

Hologic, Inc.
250 Campus Drive
Marlborough, MA 01752
UNITED STATES OF AMERICA

Agent

SMART & BIGGAR LLP
1000 RUE DE LA GAUCHETIERE OUEST,
BUREAU 3300, MONTREAL, QUEBEC,
H3B4W5

TRADEMARK DETAILS

3DQUORUM

Trademark Type

Word

Goods

Class 09

Downloadable computer software used in the field of breast imaging; downloadable computer software for radiological use in the field of medical imaging; computer software for storing, reproducing, transmitting, and processing medical data and images in the field of breast imaging; computer software for medical imaging apparatus, equipment, and system for radiological use; computer software for radiological imaging systems; computer-aided diagnostic system for radiological images consisting of computer software; computer software for screening for breast cancer

Claims

Priority Filing Date: June 27, 2018, Country or Office: UNITED STATES OF AMERICA, Application No: 88/017138 in association with the same kind of goods

Application Number 1,937,012
Language of Application English

Filing Date 2018-12-19

APPLICANT AND AGENT DETAILS

Applicant

Leviton Manufacturing Co., Inc.
201 North Service Road
Melville, NY 11747
UNITED STATES OF AMERICA

Agent

SELENA ALTRO
4141 SHERBROOKE ST. W., SUITE 650,
WESTMOUNT, QUEBEC, H3Z1B8

TRADEMARK DETAILS

INFORM

Trademark Type

Word

Goods

Class 09

Electrical Wiring Devices, namely electrical plugs, connectors, electric power receptacles, namely, power outlets and electrical load switches, pin and sleeve electrical power connectors, power strip, ground-fault circuit interrupter, surge protectors; Electrical plugs controllers for electric motors;

Application Number 1,937,023
Language of Application English

Filing Date 2018-12-19

APPLICANT AND AGENT DETAILS

Applicant

CommScope, Inc. of North Carolina
1100 CommScope Place, S.E.
Hickory, NC 28602
UNITED STATES OF AMERICA

Agent

VALERIE G. EDWARD
(Edward-IP), 100-5063 North Service Road,
Burlington, ONTARIO, L7L5H6

TRADEMARK DETAILS

IMVISION

Trademark Type

Standard Characters

Goods

Class 09

Telecommunications infrastructure management systems, namely, patch panels for housing and organizing electrical and fiber optic connectors and for managing and monitoring communications and data networking infrastructure, and electronic controllers for the automatic detection of patch cable connectivity with user guidance for planned patching and connectivity of copper and fiberoptic circuits and electronic touchscreen display interfaces, and related software for connecting, locating, managing and monitoring in-building cabling and communications and data networking infrastructure, namely the Local Area Network or Data centre monitoring and displaying circuits between switches, storage devices and computer terminals.

Application Number 1,937,039
Language of Application English

Filing Date 2018-12-19

APPLICANT AND AGENT DETAILS

Applicant

Robert Half International Inc.
2884 Sand Hill Road, Suite 200
Menlo Park, CA 94025
UNITED STATES OF AMERICA

Agent

CHITIZ PATHAK LLP
77 King Street West, TD North Tower, Suite
700, P.O. Box 118, Toronto, ONTARIO,
M5K1G8

TRADEMARK DETAILS

Trademark Type

Design

Visual Representation



Colour Claim

Colour is claimed as a feature of the trademark. The mark consists of the wording 'rh Robert Half' in stylized font. There is a red rectangle design with the white letters 'rh' in the center. To the right of this design is the stylized wording 'Robert Half' in black.

Services

Class 35

(1) Staffing in the field of electronic discovery; operation of telephone call centers for others; business project management services; business risk management; providing online business risk management services for use in project management; providing business intelligence services.

Class 37

(2) periodic upgrading of computer hardware for others

Class 42

(3) Computer project management services, namely, computer software for project management; computer forensic services, namely, digital forensic investigations in the field of computer crimes; computer services, namely, remote management of the information technology (IT) systems of others, namely, electronic messaging systems, computers, computer hardware and software, computer networks, computer networking hardware, network access server hardware, network printers, network servers, computer scanners, internet phones, intranet servers, webcams, and word processors; technical support services, namely, remote infrastructure management services, namely, monitoring, administration and management of software, cloud computing IT and application systems, namely electronic messaging systems, computers, computer hardware and software, computer networks, computer networking hardware, network access server hardware, network printers, network servers, computer scanners, internet phones, and intranet servers; periodic upgrading of computer software for others; design and development of software in the field of mobile applications; computer technical support services, namely, 24/7 service desk or help

desk services for IT infrastructure, operating systems, database systems, and web applications; website design and development for others;

Class 45

(4) Administrative and consulting services for others, namely, for supporting law firms, legal service providers and in-house legal departments, namely, electronic discovery and litigation support and consulting services for others, namely, legal support services in the nature of collection and analysis of electronic documents; electronic discovery and litigation support and consulting services for others, namely, collection and analysis of electronic documents.

Claims

Priority Filing Date: June 19, 2018, Country or Office: UNITED STATES OF AMERICA, Application No: 88/006,484 in association with the same kind of services (1), (3), (4)

Application Number 1,937,174
Language of Application English

Filing Date 2018-12-19

APPLICANT AND AGENT DETAILS

Applicant

G & S Sales Ltd.
P.O. Box 40
703 Saskatchewan Ave.
Dilke
SASKATCHEWAN
S0G1C0

Agent

OYEN WIGGS GREEN & MUTALA LLP
480-THE STATION, 601 WEST CORDOVA
STREET, VANCOUVER, BRITISH
COLUMBIA, V6B1G1

TRADEMARK DETAILS

Trademark Type

Design

Visual Representation



Goods

Class 07

Water pumps, not including machines, namely amphibious, multi-purpose dredgers for dredging, piling and raking, and dredging pumps.

Services

Class 37

Pumping water out of sloughs and flooded areas not including construction engineering services, environmental restoration, namely backhoe dredging, suction dredging, pile driving, reconstruction of shorelines, building quays, maintenance of industrial pools, flood control, building boat passages, embedding and mounting cables and pipes, excavation, maintaining rivers, canals and other waterways, and removing vegetation and repair and installation of dredgers, dredging pumps and excavators.

Application Number 1,937,366
Language of Application English

Filing Date 2018-12-20

APPLICANT AND AGENT DETAILS

Applicant

FUJITSU LIMITED
1-1, Kamikodanaka 4-chome
Nakahara-ku
Kawasaki-shi
Kanagawa 211-8588
JAPAN

Agent

SMART & BIGGAR LLP
SUITE 900, 55 METCALFE STREET, P.O.
BOX 2999, STATION D, OTTAWA, ONTARIO,
K1P5Y6

TRADEMARK DETAILS

Zinrai

Trademark Type

Word

Foreign Character Translation

The translation provided by the applicant of the Japanese word(s) ZINRAI is THUNDER.

Goods

Class 09

Cash registers; telecommunication machines and apparatus, namely, cellular phones, wireless routers, fax machines; computers; computer programs for filing tax returns, tracking package shipments; electronic machines, namely, mp3 players, video cameras, electronic book readers and replacement parts therefor; consumer video game software; consumer video game programs; electronic circuits and CD-ROMs containing recorded game programs for hand-held games with liquid crystal displays; phonograph records featuring music; electronic circuits and CD-ROMs recorded with automatic performance programs for electronic musical instruments; downloadable music files received and recorded via the internet; pre-recorded video discs and video tapes, as well as downloadable video recordings, all containing motion picture comedies, children's animation, wild animal documentaries; downloadable image, video, and movie files that are received and recorded via the internet, all featuring motion picture dramas, comedy television programs; downloadable electronic publications, namely, books, magazines, newsletters in the field of video games, automotive repair, astronomy

Services

Class 35

(1) Business management analysis and business management consultancy; Marketing research; Providing business transactional information on commodity sales; Business management and operation relating to information processing and telecommunications networks; Consultancy and operation of management or transactions of businesses, namely arranging and concluding commercial transactions for others; Auctioneering; Import-export agencies; Filing documents or magnetic-tapes, namely business file management, related to official filings; Employment agencies for engineers related to design, programming and maintenance of computer or computer programs; Employment agencies; Operation assistance to commercial businesses in the field of

computers, typewriters, cellular phones, wireless routers, fax machines, and office machines; Providing information about operation assistance to commercial businesses in the field of computers, typewriters, cellular phones, wireless routers, fax machines, and other similar office machines; Compilation of statistics into computer databases; systemization of information into computer databases; Computerized file management; Providing office functions for others, namely computerized office management, relating to order, acceptance and order placement of mail-order services; computerized searchable database management for others

Class 37

(2) Installation of electronic machines and apparatus, namely computer hardware; repair and maintenance of office machines and equipment; repair and maintenance of electronic machines and apparatus, namely mp3 players, video cameras, computer printers, computer scanners, computers and electronic book readers; repair and maintenance of telecommunication machines and apparatus, namely cellular phones, wireless routers, computer network hubs, computers and fax machines; repair and maintenance of electric household appliances

Class 38

(3) Telecommunications, namely, videoconferencing services, voicemail services, streaming of music on the internet; message sending by computer terminals, namely providing e-mail services; communications by computer terminals, namely providing access to a global computer network; radio broadcasting, television broadcasting, wireless broadcasting of films via the Internet; news agencies, namely, the transmission of news items to news reporting organizations; rental of telecommunication equipment, namely telephones and facsimile machines; telephone communication routing and junction services; teleconferencing services; resale of telecommunications lines, namely leasing of telephone lines

Class 41

(4) Educational and instruction services in the nature of classes, seminars, workshops in the fields of arts, crafts, and sports; educational examination services regarding computer software design, computer programming, and maintenance of computer software, for licensing accreditation purposes; arranging, conducting and organization of seminars in the fields of artificial intelligence, deep learning, machine learning and high performance computing; providing on-line, non-downloadable electronic publications in the nature of books, magazines, newsletters in the field of ballet chemistry, computer programming; reference libraries of literature and documentary records; providing information regarding organization, management or arrangement of horse races; translation through communication by computer terminals and other translation; publishing of electronic publications; electronic desktop publishing

Class 42

(5) Designing of machines, apparatus, instruments, namely mp3 players, video cameras, computer printers, computer scanners, computers and electronic book readers, including their parts, or systems composed of the aforesaid goods; Providing information relating to designing computers; Designing of computers, cellular phones, wireless routers, computer network hubs, fax machines; Consultancy for designing of computers, computer scanners, computer printers, cellular phones, wireless routers, computer network hubs and fax machines; Computer program design, computer programming, and maintenance of computer software; Providing information relating to computer program design, computer programming, and maintenance of computer software; computer consultation, namely computer security consultancy, computer software consultancy, consultancy in the field of computer data security, consultancy in the field of computer system analysis; Remote monitoring of the functioning and use of computer systems; optimization services for computers via software installation, configuration, or upgrades, namely, configuration, installation, and upgrading

software functions of computers, and changing and adding of software functions for computers, and providing information thereon; Designing and planning for communication network systems, namely computer network configuration services, computer network design for others, design and development of wireless computer networks; Consultancy for designing and planning communication network systems in the fields of computer network configuration services, computer network design for others, design and development of wireless computer networks; Consultancy for computer programs design, computer programming, or maintenance of computer software; Computer data encoding, namely digital compression of computer data, document data transfer from one computer format to another; Data conversion of computer program data using computers to embed and delete electronic watermark with computers; Fault diagnosis and virus testing of computer programs; Testing and research of computers and computer programs; Testing and research of computers, cellular phones, wireless routers, computer network hubs and fax machines; Testing and research of semiconductors; Testing and research of semiconductor manufacturing machines and equipment, and semiconductor measuring instruments; Rental of computers; Providing online, nondownloadable computer programs for editing videos, virus protection; computer code conversion for others; services for reproducing computer programs, namely duplication of computer programs; creation and maintenance of web sites for others; Rental of computer memory hardware

Application Number 1,937,381
Language of Application English

Filing Date 2018-12-20

APPLICANT AND AGENT DETAILS

Applicant

Cobra Labs Limited, a limited company of New Zealand
Unit 3 / 9 Oropuriri Road
Waiwhakaiho, New Plymouth
NEW ZEALAND

Agent

BERESKIN & PARR LLP/S.E.N.C.R.L., S.R.L.
SCOTIA PLAZA, 40 KING STREET WEST,
40th FLOOR, TORONTO, ONTARIO, M5H3Y2

TRADEMARK DETAILS

THE OMEN!

Trademark Type

Standard Characters

Goods

Class 05

Dietary supplements for general health and well-being;

Application Number 1,937,423
Language of Application English

Filing Date 2018-12-20

APPLICANT AND AGENT DETAILS

Applicant

A PARENT MEDIA CO. INC.
4500-855 2 St SW
Calgary
ALBERTA
T2P4K7

Agent

BENNETT JONES LLP
4500 BANKERS HALL EAST, 855 - 2ND
STREET S.W., CALGARY, ALBERTA, T2P4K7

TRADEMARK DETAILS

KIDOODLETV SAFE STREAMING

Trademark Type

Word

Services

Class 38

(1) On-line electronic transmission of information and data, namely, transmission of music, movies, computer video games, not including games of chance, and television programs for children; Audio broadcasting and transmission of educational and entertainment digital media for children, namely, streaming of video via the Internet featuring music, movies, computer video games, not including games of chance, and television programs for children for educational and entertainment purposes; Video-on-demand transmission services; Video broadcasting via the Internet, namely, streaming of audio and video via the Internet featuring music, movies, computer video games, not including games of chance, and television programs for children; Transmission of voice, audio, video, images, signals, messages and information relating to children's television programs; Entertainment and educational services, namely, distribution of educational and entertainment television and motion picture programming for others by means of digital transmission over the internet;

Class 41

(2) Organizing entertainment and educational television programs, movies, music and video games, not including games of chance, for children via the internet;

Application Number 1,937,433
Language of Application English

Filing Date 2018-12-20

APPLICANT AND AGENT DETAILS

Applicant

Sion Power Corporation
2900 East Elvira Road
Tucson, AZ 85756
UNITED STATES OF AMERICA

Agent

STIKEMAN ELLIOTT S.E.N.C.R.L., SRL/LLP
(Departement IP Department), 1155 Boul.
René-Lévesque Ouest, Bureau 4000, 41
Étage, Montréal, QUEBEC, H3B3V2

TRADEMARK DETAILS

Trademark Type

Design

Visual Representation



Goods

Class 09

Electrochemical cells and batteries, namely lithium batteries, and electrodes for batteries;

Services

Class 42

Electrochemical cell and battery design services;

Claims

Priority Filing Date: June 26, 2018, Country or Office: UNITED STATES OF AMERICA, Application No: 88015115 in association with the same kind of goods and in association with the same kind of services

Application Number 1,937,434
Language of Application English

Filing Date 2018-12-20

APPLICANT AND AGENT DETAILS

Applicant

Sion Power Corporation
2900 East Elvira Road
Tucson, AZ 85756
UNITED STATES OF AMERICA

Agent

STIKEMAN ELLIOTT S.E.N.C.R.L., SRL/LLP
(Departement IP Department), 1155 Boul.
René-Lévesque Ouest, Bureau 4000, 41
Étage, Montréal, QUEBEC, H3B3V2

TRADEMARK DETAILS

Trademark Type

Design

Visual Representation



Goods

Class 09

electrochemical cells and batteries, namely lithium batteries, and electrodes for batteries;

Services

Class 42

Electrochemical cell and battery design services;

Claims

Priority Filing Date: June 26, 2018, Country or Office: UNITED STATES OF AMERICA, Application No: 88015132 in association with the same kind of goods and in association with the same kind of services

Application Number 1,937,437
Language of Application English

Filing Date 2018-12-20

APPLICANT AND AGENT DETAILS

Applicant

Home Depot International, Inc.
2455 Paces Ferry Road, NW
Atlanta, GA 30339
UNITED STATES OF AMERICA

Agent

BERESKIN & PARR LLP/S.E.N.C.R.L., S.R.L.
SCOTIA PLAZA, 40 KING STREET WEST,
40th FLOOR, TORONTO, ONTARIO, M5H3Y2

TRADEMARK DETAILS

ORANGEPRINT

Trademark Type

Word

Goods

Class 09

Computer application software for mobile phones for home measurements for home improvement repairs, information on installation of home appliances and indoor and outdoor lighting fixtures, estimating costs for home improvement projects, home repairs and home maintenance; computer software for creating digital blueprints of the interiors and exteriors of homes and buildings incorporating dimensions, electrical control systems for heating and air conditioning systems, lighting systems, burglar alarm systems, fire alarm systems, gas leak alarm systems, home appliances, indoor and outdoor lighting fixtures, and materials of construction; computer application software for stock keeping unit (SKU) mapping that enables users to track home improvement products compatible with their home namely kitchen cabinets, tiles, furnaces, home security, air conditioners, building insulation, flooring, shower and tub, indoor window blinds, windows and doors, fences, HVAC systems, kitchen and bathroom countertops, ceiling fans and home appliances

Services

Class 35

(1) Referrals in the field of home renovations and repairs; Appointment reminder services related to home maintenance

Class 37

(2) Installation, maintenance, and repair of home improvement items namely kitchen cabinets, tiles, furnaces, home security, air conditioners, building insulation, flooring, shower and tub, indoor window blinds, windows and doors, fences, HVAC systems, kitchen and bathroom countertops, ceiling fans and home appliances; Collecting information on building dimensions, indoor and outdoor lighting fixtures, materials of construction, and home appliances, and maintenance requirements of home appliances

Class 38

(3) Providing access to an on-line interactive database of exterior and interior dimensions of building and homes; providing users access to a web-based tool, namely search engine used for

filtering products on a retail website; Providing access to a website featuring a calendar and informational videos related to home improvement and maintenance

Class 40

(4) Creating digital blueprints and representations of the interiors and exteriors of homes and buildings incorporating dimensions, systems, appliances, fixtures, and materials of construction

Class 42

(5) Providing temporary use of non-downloadable software for home measurements for home improvement repairs, information on installation of home appliances and indoor and outdoor lighting fixtures, estimating costs for home improvement projects, home repairs and home maintenance; Providing temporary use of nondownloadable software for creating digital blueprints of the interiors and exteriors of homes and buildings incorporating dimensions, electrical control systems for heating and air conditioning systems, lighting systems, burglar alarm systems, fire alarm systems, gas leak alarm systems, home appliances, indoor and outdoor lighting fixtures, and materials of construction; Providing temporary use of non-downloadable software for stock keeping unit (SKU) mapping that enables users to track home improvement products compatible with their home namely kitchen cabinets, tiles, furnaces, home security, air conditioners, building insulation, flooring, shower and tub, indoor window blinds, windows and doors, fences, HVAC systems, kitchen and bathroom countertops, ceiling fans and home appliances

Application Number 1,937,439
Language of Application English

Filing Date 2018-12-20

APPLICANT AND AGENT DETAILS

Applicant

A PARENT MEDIA CO. INC.
4500-855 2 St SW
Calgary
ALBERTA
T2P4K7

Agent

BENNETT JONES LLP
4500 BANKERS HALL EAST, 855 - 2ND
STREET S.W., CALGARY, ALBERTA, T2P4K7

TRADEMARK DETAILS

Trademark Type

Design

Visual Representation



Colour Claim

Colour is claimed as a feature of the trade-mark. The letter 'K' is upper case, 'o' is lower case and 'L' is upper case and all are in red. The letter 'i' is lower case, 'o' is lower case and 'e' is lowercase and all are in yellow. The letter 'D' is uppercase, 'd' is lowercase and the box around the letters 'tv' are all in blue. The letters 'tv' lowercase and are white surrounded by a blue box. The letters KiDoodLetv are on the top line. Below them are the words 'safe streaming' in black.

Services

Class 38

(1) On-line electronic transmission of information and data, namely, transmission of music, movies, computer video games, not including games of chance, and television programs for children; Audio broadcasting and transmission of educational and entertainment digital media for children, namely, streaming of video via the Internet featuring music, movies, computer video games, not including games of chance, and television programs for children for educational and entertainment purposes; Video-on-demand transmission services; Video broadcasting via the Internet, namely, streaming of audio and video via the Internet featuring music, movies, computer video games, not including games of chance, and television programs for children; Transmission of voice, audio, video, images, signals, messages and information relating to children's television programs; Entertainment and educational services, namely, distribution of educational and entertainment television and motion picture programming for others by means of digital transmission over the internet;

Class 41

(2) Organizing entertainment and educational television programs, movies, music and video games, not including games of chance, for children via the internet;

Application Number 1,937,455
Language of Application English

Filing Date 2018-12-20

APPLICANT AND AGENT DETAILS

Applicant

A PARENT MEDIA CO. INC.
4500-855 2 St SW
Calgary
ALBERTA
T2P4K7

Agent

BENNETT JONES LLP
4500 BANKERS HALL EAST, 855 - 2ND
STREET S.W., CALGARY, ALBERTA, T2P4K7

TRADEMARK DETAILS

Trademark Type

Design

Visual Representation



Colour Claim

Colour is claimed as a feature of the trade-mark. The letter 'K' is upper case, 'o' is lower case and 'L' is upper case and all are in red. The letter 'i' is lower case, 'o' is lower case and 'e' is lowercase and all are in yellow. The letter 'D' is uppercase, 'd' is lowercase and the box around the letters 'tv' are all in blue. The letters 'tv' lowercase and are white surrounded by a blue box.

Services

Class 35

(1) Promoting the goods of others, namely, providing online discount information and purchasing services of vouchers, gift certificates, coupons and other discounts for the promotion and sale of goods and services of others; Promotional services, namely, promoting the goods of others by means of providing digital coupons, rebates and vouchers distributed electronically to computers, mobile phones, computers and tablets; On-line electronic transmission of information and data, namely, transmission of music, movies, Computer video games, not including games of chance, and television programs for children; Audio broadcasting and transmission of educational and entertainment digital media for children, namely, streaming of video via the Internet featuring music, movies, computer video games, not including games of chance, and television programs for children for educational and entertainment purposes; Video-on-demand transmission services; Video broadcasting via the Internet, namely, streaming of audio and video via the Internet featuring music, movies, Computer video games, not including games of chance, and television programs for children; Transmission of voice, audio, video, images, signals, messages and information relating to children's television programs; Entertainment and educational services, namely, distribution of educational and entertainment television and motion picture programming for others by means of digital transmission over the internet;

Class 41

(2) Organizing entertainment and educational television programs, movies, music and video games, not including games of chance, for children via the internet

Application Number 1,937,482
Language of Application English

Filing Date 2018-12-20

APPLICANT AND AGENT DETAILS

Applicant

Skagerak Denmark A/S
Slotspladsen 4
9000 Aalborg
DENMARK

Agent

CLARK WILSON LLP
900 - 885 WEST GEORGIA STREET,
VANCOUVER, BRITISH COLUMBIA, V6C3H1

TRADEMARK DETAILS

SKAGERAK

Trademark Type

Standard Characters

Goods

Class 02

(1) Paints, varnishes, lacquers for use in the manufacture of furniture; preservatives against rust and against deterioration of wood; colorants for the restoration of furniture in the form of markers, and colorants for use in the manufacture of paint; mordant dyes; raw natural resins; metals in foil and powder form for painters, decorators, printers and artists; wood preserving oils

Class 03

(2) Bleaching preparations for laundry use; all-purpose cleaning and polishing preparations; all-purpose scouring liquids and powders; general use abrasives; soaps, namely soaps for body care, soaps for household use, and soaps for laundry use; perfumery; essential oils, namely essential oils as fragrances for laundry use, essential oils for aromatherapy, and essential oils for cosmetic purposes; cosmetics; hair lotions; dentifrices

Class 11

(3) Apparatus for lighting, namely desk lamps, floor lamps, reading lamps, table lamps, oil lamps, lamp shades, lamp chimneys, light bulbs, and lanterns for lighting; fireplaces; acetylene flares; cooking appliances, namely, electric griddles

Class 18

(4) Leather and imitation leather; animal skins, hides; trunks and travelling bags; umbrellas, parasols and walking sticks; whips and saddlery, furniture coverings of leather, boxes and storage boxes of leather, leather board or imitations of leather

Class 20

(5) Furniture, mirrors, picture frames; tables, furniture benches, outdoor benches, chairs, deck chairs, recliners, armchairs, furniture for children, garden furniture, sofas, tray tables, coffee tables, chests of drawers, storage racks, cupboards, console tables, footstools, plant stands, decorative wood trays and bins; chests, not of metal, and caskets for storage, containers, not of metal, for storage and transport; baskets, not of metal; baker's bread baskets; cloth laundry baskets, and cloth storage baskets for household purposes; packaging containers of plastic; figurines and works of art of wood, wax, plaster or plastic; handles for doors, cabinets and drawers, not of metal;

hooks, not of metal, for clothing and textiles; coathooks, not of metal; hooks, not of metal, for clothing and textiles; library shelves, magazine racks, keyboards for hanging keys, key cabinets and key boxes; bookcases (furniture), clothes hangers, shelves for storage, pillows, scatter cushions, seat cushions, cushions, garden cushions, door mats of wood, bath mats of wood, picture frames; birdhouses and bird boxes, bee hives

Class 21

(6) Household or kitchen utensils and containers, namely, spatulas for kitchen use, graters for kitchen use, sieves for household purposes, turners being kitchen utensils, pot and pan scrapers, wood chopping blocks, and kitchen containers for rice and pasta; hair combs; bath sponges and kitchen cleaning sponges; brushes; brush-making materials; articles for cleaning purposes, namely steel wool and besoms; steelwool; unworked or semi-worked glass (except glass used in buildings); beverage glassware and decorative figurine glassware; porcelain and earthenware, namely, mugs, cups and bowls; dustbins; trays for domestic purposes, namely baking trays, crumb trays, cutlery trays, meal trays, paper trays, serving trays, oil and vinegar trays, wine trays, and trays for candles; shaving brush stands; plastic, wooden and porcelain general purpose storage containers; heat insulating containers for beverages; tableware, other than knives, forks and spoons, namely dishes; drink coasters, not of paper and other than table linen; glass mats, not of paper and other than table linen, namely glass baking mats, and glass place mats; bread bins; biscuit tins; birdcages, birdhouses, fat-ball holders, gardening gloves, oven gloves, towel holders, towel rails and rings, domestic rolling pins, jugs, candle extinguishers, candlesticks, candle holders, menu card holders, nail brushes, china ornaments, bottle openers (kitchen utensils), salt and pepper shakers, hand-operated salt and pepper mills, pots, corkscrews; napkin holders, napkin rings; basins, namely bowls; fruit cups, butter dishes, chopping boards for kitchen use, breakfast boards for kitchen use, soap dispensers, soap boxes, soap containers, soap holders, dishes for soap, toothbrush mugs and toothbrush mug holders, toothpick holders, kitchen towel holders, toilet paper holders, drying racks for washing, flower pots, flower pot covers, not of paper; vases, washtubs, egg cups; serving cutlery (kitchen utensils), mixing spoons (kitchen utensils); jardinieres

Class 24

(7) Textiles and textile goods, namely, kitchen towels, bathroom towels, lap blankets, and bed linen; bed covers; table covers; mattress covers, upholstery fabrics, furniture coverings of textile, furniture coverings of plastic, plastic material substitute for fabrics; kitchen and table linen, bed clothes, bath linen

Class 28

(8) Games and playthings, namely board games; gymnastic and sporting articles, namely petanque and croquet sets and bats for baseball; decorations for Christmas trees; swings; Christmas tree stands, candle holders for Christmas trees; ornaments for Christmas trees, except illumination articles and confectionery

Services

Class 35

Advertising the goods and services of others; assistance in management of business activities, namely business management assistance; business administration services; sales promotion for others by means of privileged user cards and trading stamp schemes; organisation of exhibitions for commercial or advertising purposes of a variety of goods for others; retailing and wholesaling and sale via information networks of hand tools and instruments (hand-operated), cutlery, side arms, serving cutlery, mixing spoons, apparatus for lighting, lamps, oil lamps, lamp shades, lamp

chimneys, light bulbs, lanterns for lighting, fireplaces, braziers, flares, griddles, leather and imitations of leather, animal skins, hides, trunks and travelling bags, umbrellas and parasols, walking sticks, whips and saddlery, furniture coverings of leather, boxes and storage boxes of leather, leather board or imitations of leather, furniture, mirrors, picture frames, tables, benches, chairs, desk chairs, recliners, armchairs, furniture for children, garden furniture, sofas, tray tables, coffee tables, chests of drawers, racks, cupboards, console tables, footstools, plant stands, flower planters, trays, not of metal, trays and bins of wood, chests and caskets for storage, containers, not of metal, for storage and transport, baskets, not of metal, bread baskets, baskets, packaging containers of plastic, figurines and works of art of wood, wax, plaster or plastic, handles for doors, cabinets and drawers, not of metal, hooks, not of metal, for clothing and textiles, hooks, not of metal, for clothes rails, hooks, not of metal, for magazine racks, keyboards for hanging keys, key cabinets and key boxes, bookcases, clothes hangers, shelves for storage, pillows, scatter cushions, seat cushions, cushions, garden cushions, door mats of wood, bath mats of wood, picture frames, household or kitchen utensils and containers, combs and sponges, brushes, brush-making materials, articles for cleaning purposes, steelwool, unworked or semi-worked glass (except glass used in building), glassware, porcelain and earthenware, dustbins, trays for domestic purposes, serving trays, oil and vinegar trays, wine trays, trays for candles, shaving brush stands, storage containers, heat insulating containers for beverages, tableware, other than knives, forks and spoons, coasters, not of paper and other than table linen, glass mats, not of paper and other than table linen, bread bins, cookie jars, birdcages, birdhouses, fat ball holders, gardening gloves, oven gloves, towel holders, towel rails and rings, domestic rolling pins, jugs, knife holders, candle extinguishers, candlesticks, candle holders, menu card holders, nail brushes, china ornaments, bottle openers, salt and pepper shakers, hand-operated salt and pepper mills, pots, corkscrews, napkin holders, napkin rings, bowls (basins), fruit cups, butter dishes, chopping boards for kitchen use, breakfast boards for kitchen use, soap dispensers, soap boxes, soap containers, soap holders, dishes for soap, toothbrush mugs and toothbrush mug holders, toothpick holders, kitchen towel holders, toilet paper holders, drying racks for washing, flower pots, flower pot covers, not of paper, basins (bowls), vases, washtubs, egg cups, textiles and textile goods, bed and table covers, mattress covers, upholstery fabrics, furniture coverings of textile, furniture coverings of plastic, plastic material (substitute for fabrics), games and playthings, gymnastic and sporting articles, Christmas decorations, swings, Christmas tree stands, candle holders for Christmas trees, ornaments for Christmas trees, except illumination articles and confectionery; online advertising for others via a computer communications network; distribution of samples

Application Number 1,937,813
Language of Application English

Filing Date 2018-12-21

APPLICANT AND AGENT DETAILS

Applicant

SaS-Tec GmbH
Volmarstr. 5
D-71706 Markgroningen
GERMANY

Agent

MOFFAT & CO.
P.O. Box 2088, Station D, Ottawa, ONTARIO,
K1P5W3

TRADEMARK DETAILS

SAS-TEC

Trademark Type

Word

Goods

Class 17

(1) Insulating materials of plastics for energy and shock absorption; elastic materials of plastic, namely sheets of shock absorbent padding; shock- and impact-absorbing materials, namely shock absorbent padding and insulation material for use in manufacturing padding for impact and shock protection, all of the foregoing being for use in the manufacture of protective padding and protective inserts for clothing and suits for the human body

Class 28

(2) Protective padding for sports suits, knee guards and elbow guards, all of the foregoing being shockabsorbing protectors for motorcyclists; Protective paddings for playing sports; Protective equipment for protecting from injury, namely arm, shoulder, elbow, knee, shin, hip, tailbone, chest, back, knuckle, wrist and ankle protectors for athletic and sporting use; sports articles being shock-absorbing protective elements, namely arm, shoulder, elbow, knee, shin, hip, tailbone, chest, back, knuckle, wrist and ankle protectors for athletic and sporting use; Wrist protectors, namely wrist pads; Spine protectors, namely spine pads; Receptacles and holders for protective padding, inserts and guards for athletic and sporting use

Application Number 1,937,815
Language of Application English

Filing Date 2018-12-21

APPLICANT AND AGENT DETAILS

Applicant

AM Royalties Limited Partnership
2500 - 700 West Georgia Street
Vancouver
BRITISH COLUMBIA
V7Y1B3

Agent

BLAKE, CASSELS & GRAYDON LLP
INTELLECTUAL PROPERTY GROUP, SUITE
4000, COMMERCE COURT WEST, 199 BAY
STREET, TORONTO, ONTARIO, M5L1A9

TRADEMARK DETAILS

Trademark Type

Design

Visual Representation



Services

Class 35

advertising and promotion of wares and services of others by means of an incentive rewards program; organization, operation and supervision of sales and promotional incentive schemes

Application Number 1,938,079
Language of Application English

Filing Date 2018-12-24

APPLICANT AND AGENT DETAILS

Applicant

SomnoMed Limited
Level 3, 20 Clarke Street
Crows Nest, New South Wales 2065
AUSTRALIA

Agent

DEETH WILLIAMS WALL LLP
150 YORK STREET, SUITE 400, TORONTO,
ONTARIO, M5H3S5

TRADEMARK DETAILS

SOMNODENT FUSION

Trademark Type

Standard Characters

Goods

Class 10

Surgical, medical, dental, and veterinary apparatus for diagnosis and treatment of snoring, sleep disorders, and sleep apnea; surgical, dental, and veterinary instruments, and medical instruments for diagnosis and treatment of snoring, sleep disorders, and sleep apnea; oral appliances, namely, therapeutic mouthpieces used to treat snoring, sleep disorders, and sleep apnea; analytical devices for medical purposes, namely, medical devices for analysing brain waves and breathing patterns, mandibular movements, snoring sounds, and snoring amplitude, all for diagnosis and treatment of snoring, sleep disorders, and sleep apnea; diagnostic devices for medical purposes, namely, medical devices for the quantitative detection of oxygen level in the blood, for the detection of apnea or hypopnea events using an apnea-hypopnea index (AHI) or oxygen desaturation index (ODI) measurement using in mouth sensors, and for the measurement of in-mouth compliance of therapeutic mouthpieces, all for diagnosis of snoring, sleep disorders, and sleep apnea; splints for dental and orthodontic purposes; dentures; dental adjustments, namely, dental instruments used to construct accurate and reliable bite records for patients; dental pins; mandibular splints and orthosis as medical devices for the treatment of snoring and sleep apnoea

Claims

Priority Filing Date: December 21, 2018, Country or Office: AUSTRALIA, Application No: 1977372 in association with the same kind of goods

Application Number 1,938,081
Language of Application English

Filing Date 2018-12-24

APPLICANT AND AGENT DETAILS

Applicant

SomnoMed Limited
Level 3, 20 Clarke Street
Crows Nest, New South Wales 2065
AUSTRALIA

Agent

DEETH WILLIAMS WALL LLP
150 YORK STREET, SUITE 400, TORONTO,
ONTARIO, M5H3S5

TRADEMARK DETAILS

SOMNODENT AVANT

Trademark Type

Standard Characters

Goods

Class 10

Surgical, medical, dental, and veterinary apparatus for diagnosis and treatment of snoring, sleep disorders, and sleep apnea; surgical, dental, and veterinary instruments, and medical instruments for diagnosis and treatment of snoring, sleep disorders, and sleep apnea; oral appliances, namely, therapeutic mouthpieces used to treat snoring, sleep disorders, and sleep apnea; analytical devices for medical purposes, namely, medical devices for analysing brain waves and breathing patterns, mandibular movements, snoring sounds, and snoring amplitude, all for diagnosis and treatment of snoring, sleep disorders, and sleep apnea; diagnostic devices for medical purposes, namely, medical devices for the quantitative detection of oxygen level in the blood, for the detection of apnea or hypopnea events using an apnea-hypopnea index (AHI) or oxygen desaturation index (ODI) measurement using in mouth sensors, and for the measurement of in-mouth compliance of therapeutic mouthpieces, all for diagnosis of snoring, sleep disorders, and sleep apnea; splints for dental and orthodontic purposes; dentures; dental adjustments, namely, dental instruments used to construct accurate and reliable bite records for patients; dental pins; mandibular splints and orthosis as medical devices for the treatment of snoring and sleep apnoea

Claims

Priority Filing Date: December 21, 2018, Country or Office: AUSTRALIA, Application No: 1977371 in association with the same kind of goods

Application Number 1,938,096
Language of Application English

Filing Date 2018-12-24

APPLICANT AND AGENT DETAILS

Applicant

Globe Union Industrial Corp.
22, Chien-Kuo Road
Taichung Processing Export Zone
TAIWAN

Agent

MARKS & CLERK
33 Yonge Street, , Suite 300, Toronto,
ONTARIO, M5E1G4

TRADEMARK DETAILS

Trademark Type

Design

Visual Representation



DROP
&
LOCK

Goods

Class 11

faucets

Application Number 1,938,102
Language of Application English

Filing Date 2018-12-24

APPLICANT AND AGENT DETAILS

Applicant

VOLKSWAGEN AKTIENGESELLSCHAFT
Berliner Ring 2,
38440
Wolfsburg
GERMANY

Agent

MARKS & CLERK
33 Yonge Street, , Suite 300, Toronto,
ONTARIO, M5E1G4

TRADEMARK DETAILS

MOIA

Trademark Type

Word

Goods

Class 16

(1) Paper, cardboard, display banners of cardboard, adhesive labels of paper, advertisement boards of paper or cardboard, advertisement signs of paper, badges of cardboard, paper labels, wrapping paper, paper ribbons; printed matter, namely pamphlets, brochures, manuals, magazines, articles, commentary and books; works of art and figurines of paper and cardboard, and architects' models; decorations, namely, art prints, art pictures, framed art prints, framed artwork, printed art reproductions, posters; art materials, namely, art kits comprising colored pencils, paint brushes, markers, graphite pencils, pencil sharpeners, erasers, drawing pads and coloring pages, art pads, art paper, arts and crafts paint kits; filter paper; bags for packaging; articles for packaging, namely, adhesive plastic film for packaging, cellulose acetate film for packaging, bags of paper and plastics for packaging, cardboard packaging, envelopes of paper and plastic for packaging, packaging materials of paper and cardboard, paper for wrapping and packaging, plastic bubble packs for packaging; bookbinding material; photographs; stationery, namely, paper stationery, stationery agendas, binders, cases, folders, labels, personal organizers, pencils, pens, stickers, tabs and writing stationery; adhesives (glues) for stationery or household purposes; artists materials, namely, artists' brushes, easels, moulds, palettes, pastels, pencils, pens, sketch books; paintbrushes; typewriters, pens and office articles excluding furniture, namely, calendars, binders for the office, clipboards, glue for the office, hole punchers, lettering machines, paper shredders, staplers and sealing machines for office use; instructional and teaching material except apparatus, namely, printed vehicle manuals for instructional purposes; packaging materials made of plastics, namely, adhesive plastic film for packaging, plastic bags for packaging, envelopes of plastic for packaging; printing type; printing blocks; atlases, calendars, geographical maps; printed publications in the nature of books, booklets, magazines, journals, manuals, brochures, leaflets, pamphlets and newsletters; printed advertising articles and printed advertising materials, namely, printed advertising boards of paper and cardboard and printed advertising material in the nature of leaflets, pamphlets, signs of cardboard and printed art; photographs [printed]; document file folders, document portfolios; pens [office requisites]; ball-point pens and pencils; flags of paper; table napkins of paper; copying paper [stationery]; hygienic paper; packing paper; ink; paper seals, stationery seals, sealing stamps; drawing instruments and materials,

namely, drawing boards, drawing brushes, drawing compasses, drawing paper, drawing pads, drawing pencils, drawing pens, drawing protractors, drawing rulers, drawing squares, drawing markers; modeling materials, namely, modeling clays and moulds.

Class 18

(2) Animal skins and hides; umbrellas and parasols; walking sticks; trunks (luggage); luggage; bags, in particular sports bags and briefcases; wallets, purses; key cases; goods made from leather and imitations of leather, namely umbrellas and parasols, trunks (luggage), luggage, bags, in particular sports bags and briefcases, wallets, purses, key cases, handbags, travelling bags, rucksacks; leather, unworked or semiworked; handbags; travelling bags; rucksacks; Imitation leather; skins and fur; animal skins; saddlery, whips and animal apparel.

Class 25

(3) Polo-shirts, jumpsuits, shirts, coats, jackets, neckerchiefs, pants, trousers, t-shirts; layette [clothing]; bathing suits; raincoat; theatrical costume, shoes, football shoes, hats, caps, stockings, gloves [clothing], scarfs, shawls, neckties, girdles, shower caps.

Class 28

(4) Games and playthings, namely, scale model vehicles, toy vehicles, scale model automobiles, toy automobiles;

Application Number 1,938,138
Language of Application English

Filing Date 2018-12-27

APPLICANT AND AGENT DETAILS

Applicant

J. MACEDO S/A
Rua Benedito Macedo, 79
Fortaleza, CEARÁ, 60.180-415
BRAZIL

Agent

MLT AIKINS LLP
2100 Livingston Place, 222-3rd Avenue SW,
Calgary, ALBERTA, T2P0B4

TRADEMARK DETAILS

DONA BENTA

Trademark Type

Word

Foreign Character Translation

Ms. Benta

Goods

Class 30

Farinaceous foods, namely farinaceous food pastes; cake, pudding and flour mixes; ferments, namely, yeast, yeast extracts for food and human consumption, yeast powder; cakes, bread, pastas, pudding and biscuits; corn meals, wheat meals and flour-based prepared meals; dulce de leche.

Application Number 1,938,325
Language of Application English

Filing Date 2018-12-28

APPLICANT AND AGENT DETAILS

Applicant

COLLECTIVE ARTS LIMITED
207 Burlington St E
Hamilton
ONTARIO
L8L4H2

Agent

OSLER, HOSKIN & HARCOURT LLP
SUITE 6200, P.O. BOX 50, 1 FIRST
CANADIAN PLACE, TORONTO, ONTARIO,
M5X1B8

TRADEMARK DETAILS

HAZY STATE

Trademark Type

Word

Goods

Class 32

Beer; Non-alcoholic beverages, namely sparkling water and sparkling fruit and vegetable juice.

Application Number 1,938,359
Language of Application English

Filing Date 2018-12-28

APPLICANT AND AGENT DETAILS

Applicant

SK Primacor Americas LLC
11700 Katy Freeway, Suite 900
Houston, TX 77079
UNITED STATES OF AMERICA

Agent

BORDEN LADNER GERVAIS LLP
1200 WATERFRONT CENTRE, 200
BURRARD STREET, P.O. BOX 48600,
VANCOUVER, BRITISH COLUMBIA, V7X1T2

TRADEMARK DETAILS

PRIMACOR IO

Trademark Type

Standard Characters

Goods

Class 01

(1) Ionomer products, namely unprocessed synthetic, artificial, polymer and acrylic resins in the nature of ionomer resins, unprocessed EAA (ethylene acrylic acid)-based ionomer resins, unprocessed EMAA (ethylene methacrylic acid)-based ionomer resins

Class 17

(2) Ionomer products, namely semi-processed synthetic, artificial, polymer and acrylic resins in the nature of ionomer resins, semi-processed EAA (ethylene acrylic acid)-based ionomer resins, semi-processed EMAA (ethylene methacrylic acid)-based ionomer resins

Application Number 1,938,401
Language of Application English

Filing Date 2018-12-28

APPLICANT AND AGENT DETAILS

Applicant

RYAN CHUTE GROUP OF COMPANIES INC.
37 Black Rock Lane
Portuguese Cove
NOVA SCOTIA
B3V1J9

Agent

OLLIP P.C.
Gladwin Business Park, 2212 Gladwin
Crescent, Building B, Unit B4, Ottawa,
ONTARIO, K1B5N1

TRADEMARK DETAILS

WIZARD OF SALES

Trademark Type

Standard Characters

Goods

Class 09

(1) Books namely, downloadable digital books; Downloadable digital publications namely, books, journal articles and periodicals;

Class 16

(2) Pens

(3) books; letterhead paper;

Class 18

(4) Bags namely all-purpose carrying bags and tote bags

Class 21

(5) Mugs

Class 25

(6) Casual clothing, athletic clothing, jackets, and hats

Services

Class 35

(1) Marketing services, namely, organizing and conducting advertising campaigns for the products and services of others, evaluating markets for the existing products and services of others, consulting services in the fields of business management, motivating employees, and improving sales performance

Class 41

(2) Training services in the fields of sales techniques and strategies, and effectively using charisma, persuasion and negotiation to improve sales performance

(3) Online publication of electronic books, journals and journal articles;

Application Number 1,938,458
Language of Application English

Filing Date 2018-12-28

APPLICANT AND AGENT DETAILS

Applicant

Mindfulness Without Borders, Inc., a non-profit corporation
17 Tara Hill Rd
Tiburon, CA 94920
UNITED STATES OF AMERICA

Agent

YURI CHUMAK
c/o Dickinson Wright LLP, 199 Bay Street,
Suite 2200, Toronto, ONTARIO, M5L1G4

TRADEMARK DETAILS

MINDFULNESS WITHOUT BORDERS

Trademark Type

Standard Characters

Goods

Class 09

(1) Electronic publications in the field of mindfulness practices, social and emotional learning (SEL), mindfulness and meditation, emotional intelligence, communication skills, listening skills, conflict resolution skills, life skills, leadership skills, and personal and professional development; Digital materials, namely, audio and video recordings featuring guided meditations and music for use with mindfulness practices

Class 16

(2) Educational publications, namely, facilitator manuals and participant workbooks in the field of mindfulness practices, social and emotional learning (SEL), mindfulness and meditation, emotional intelligence, communication skills, listening skills, conflict resolution skills, life skills, leadership skills, and personal and professional development; Printed matter, namely, certificates, conversation cards and motivational posters.

Services

Class 41

Educational research services; Educational services, namely, providing web-based, classroom-based programs and training for certification of facilitators in mindfulness practices, social and emotional learning (SEL), mindfulness and meditation, emotional intelligence, communication skills, listening skills, conflict resolution skills, life skills, and leadership skills and continuing education for facilitators; Arranging and facilitating personal and professional development workshops, training courses and certification training programs; Conducting personal and professional development workshops, courses, seminars and facilitator training in mindfulness practices, social and emotional learning (SEL), mindfulness and meditation, emotional intelligence, communication skills, listening skills, conflict resolution skills, life skills, and leadership skills; Mindfulness and meditation training; Providing courses of instruction at middle and high school, college, university, post-graduate levels in mindfulness practices, social and emotional learning (SEL), mindfulness and meditation, emotional intelligence, communication skills, listening skills, conflict resolution skills, life skills, and leadership skills; Providing courses of instruction to

corporate and healthcare audiences in mindfulness practices, social and emotional learning (SEL), mindfulness and meditation, emotional intelligence, communication skills, listening skills, conflict resolution skills, life skills, and leadership skills; Providing online information featuring online courses, workshops, training programs, instruction, information, guided meditations, and audio and video presentations in the field of mindfulness practices, social and emotional learning (SEL), mindfulness and meditation, emotional intelligence, communication skills, listening skills, conflict resolution skills, life skills, leadership skills, and personal and professional development by way of a website and social media.

Application Number 1,938,599
Language of Application English

Filing Date 2018-12-31

APPLICANT DETAILS

Applicant

QSM Quality Services Management Inc.
148 Yale Avenue
Winnipeg
MANITOBA
R3M0L7

TRADEMARK DETAILS

DirectorPrep.com

Trademark Type

Word

Services

Class 41

Providing board governance training and skills development for members of a board of directors from a website

Application Number 1,938,601
Language of Application English

Filing Date 2018-12-31

APPLICANT DETAILS

Applicant

QSM Quality Services Management Inc.
148 Yale Avenue
Winnipeg
MANITOBA
R3M0L7

TRADEMARK DETAILS

The Savvy Director

Trademark Type

Word

Services

Class 41

Providing board governance training and skills development for members of a board of directors from an online blog

Application Number 1,938,668
Language of Application English

Filing Date 2019-01-02

APPLICANT AND AGENT DETAILS

Applicant

Backcountry.com, LLC
1678 Redstone Center Dr
Park City, UT 84098
UNITED STATES OF AMERICA

Agent

CLARK WILSON LLP
900 - 885 WEST GEORGIA STREET,
VANCOUVER, BRITISH COLUMBIA, V6C3H1

TRADEMARK DETAILS

Trademark Type

Design

Visual Representation



Goods

Class 20

(1) Furniture for camping for use in motor homes; sleeping pads; cushions; bolsters; settees; air mattresses (not for medical purposes); mattresses; nonmetal tent poles; nap mats; sleeping mats for camping; inflatable mattresses for use when camping; camp chairs and camping tables; inflatable cushions, other than for medical purposes; air mattresses for use when camping; floating inflatable mattresses; nonmetal tent rings and tent stakes

Class 22

(2) Tarpaulins; canopies; ropes; ropes, not of metal; climbing ropes; mountaineering ropes; ropes for tents; tents; tents for mountaineering or camping; rain flies for tents; awnings for tents; drop cloths; tents for vehicles; washing lines; cords for hanging pictures

Class 24

(3) Sleeping bags; sleeping bag covers

Class 26

(4) Stud buttons of plastic for tentage

Application Number 1,938,698
Language of Application English

Filing Date 2019-01-02

APPLICANT AND AGENT DETAILS

Applicant

KIRIN HOLDINGS KABUSHIKI KAISHA (also trading as Kirin Holdings Company, Limited)
10-2, Nakano 4-Chome
Nakano-Ku, Tokyo
JAPAN

Agent

MARKS & CLERK
180 Kent Street, Suite 1900, Ottawa,
ONTARIO, K1P0B6

TRADEMARK DETAILS

Trademark Type

Design

Visual Representation



Goods

Class 05

Anti-epileptic pharmaceutical preparations; anti-fibrotic pharmaceutical preparations; antiviral pharmaceutical preparations; pharmaceutical preparations and substances for the treatment of diabetes; pharmaceutical preparations and substances for the treatment of gastrointestinal diseases; pharmaceutical preparations for the treatment of hypertension; pharmaceutical preparations for the treatment of gastrointestinal diseases, cancer, bacterial skin infections; human vaccines; veterinary pharmaceutical preparations for the treatment of vitamin deficiencies, intestinal bacteria; veterinary vaccines; pharmaceutical preparations for the treatment of influenza, colds, physical disorder and fatigue; pharmaceutical preparations for maintaining a balance of skin flora and enhancing skin barrier functions; pharmaceutical preparations for treatment of anemia; pharmaceutical preparations for treatment of leukopenia; pharmaceutical preparations for mobilization of peripheral blood progenitor cell; pharmaceutical preparations for treatment of hyperphosphatemia; pharmaceutical preparations for treatment of hyperparathyroidism; pharmaceutical preparations for treatment of cancer; pharmaceutical preparations for treatment of leukemia; pharmaceutical preparations for treatment of influenza; pharmaceutical preparations for

treatment of HIV; pharmaceutical preparations for treatment of myelodysplastic syndrome; pharmaceutical preparations for treatment of hepatitis virus infection; pharmaceutical preparations for treatment of autoimmune hepatitis; pharmaceutical preparations for conditioning treatment prior to hematopoietic stem cell transplantation; pharmaceutical preparations for treatment of hypophosphatemia; pharmaceutical preparations for improving wearing-off phenomenon in Parkinson's disease; stem cells for medical purposes; bacteriological culture mediums for medical and veterinary purposes; cell culture mediums for medical and veterinary laboratory use; cell culture media for medical laboratory use; reagent paper for medical purposes; gauze for dressings; empty capsules for pharmaceuticals; absorbent cotton; adhesive plasters; bandages for dressings; lacteal flour for babies; anti-oxidants for use as dietary supplements; dietary food supplements in the nature of ready-to-eat protein bars; dietary supplement drink mixes for general health and wellbeing; dietary supplements consisting of amino acids; dietary supplements consisting of minerals; dietary supplements consisting of vitamins; dietary supplements consisting primarily of iron; dietary supplements for body weight control; dietary supplements for controlling cholesterol; dietary supplements for general health and well-being; dietary supplements consisting of oligosaccharides; dietary supplements consisting of hop extracts for general health and well-being; dietary supplements consisting of matured hop extracts for general health and well-being; dietary supplements consisting of hop extracts for reducing cholesterol; dietary supplements consisting of matured hop extracts for reducing cholesterol; dietary supplements consisting of hop extracts for reducing body fat; dietary supplements consisting of matured hop extracts for reducing body fat; dietary supplements consisting of hop extracts for maintaining cognitive function; and dietary supplements consisting of matured hop extracts for maintaining cognitive function; dietary supplements consisting of lactic acid bacteria; diabetic fruit juice beverages adapted for medical purposes; electrolyte replacement beverages for medical purposes; malted milk beverages for invalids; medicated beverages in the nature of dietary supplements for colon detoxification; medicated beverages in the nature of dietary supplements for liver detoxification; dietetic sugar for medical purposes; dietetic substances consisting of vitamins, minerals, amino acids and trace elements; dietetic substances consisting of oligosaccharides; dietetic substances consisting of hop extracts adapted for medical use for the prevention and treatment of iron deficiency and anaemia in humans; dietetic substances consisting of matured hop extracts adapted for medical use for the prevention and treatment of iron deficiency and anaemia in humans; dietetic substances consisting of hop extracts for reducing body fat; dietetic substances consisting of matured hop extracts for reducing body fat; dietetic substances consisting of hop extracts for maintaining cognitive function; and dietetic substances consisting of matured hop extracts for maintaining cognitive function; dietetic substances consisting of lactic acid bacteria; beverages for babies adapted for medical purposes; food for babies; glucose dietary supplements for animals; herbal and dietary supplements to aid in milk production in lactating animals; linseed dietary supplements for animals; mineral dietary supplements for animals; yeast dietary supplements for animals; oligosaccharides dietary supplements for animals; hop extracts-dietary supplements for animals containing cannabis for medicinal purposes; matured hop extracts-dietary supplements for animals containing cannabis for medicinal purposes; hop extracts-dietary supplements for animals for the prevention and treatment of iron deficiency and anaemia in animals; matured hop extracts-dietary supplements for animals for the prevention and treatment of iron deficiency and anaemia in animals; hop extracts-dietary supplements for animals for reducing body fat; matured hop extracts-dietary supplements for animals for reducing body fat; hop extracts-dietary supplements for animals for maintaining cognitive function; and matured hop extracts-dietary supplements for animals for maintaining cognitive function; lactic acid bacteria-dietary supplements for animals.

Application Number 1,938,767
Language of Application English

Filing Date 2019-01-02

APPLICANT AND AGENT DETAILS

Applicant

Thermal Solutions Manufacturing, Inc.
15 Century Boulevard
Suite 102
Nashville, TN 37214
UNITED STATES OF AMERICA

Agent

GOWLING WLG (CANADA) LLP
550 BARRARD STREET, SUITE 2300,
VANCOUVER, BRITISH COLUMBIA, V6C2B5

TRADEMARK DETAILS

THERMAL PRISM

Trademark Type

Word

Goods

Class 07

Heat dispersion units, namely, heat exchangers, radiators, oil coolers and evaporative air coolers being parts for use with heavy duty industrial and commercial machinery, namely fracking, extraction and mining machines.

Claims

Priority Filing Date: July 05, 2018, Country or Office: UNITED STATES OF AMERICA, Application No: 88/027,006 in association with the same kind of goods

Application Number 1,938,831
Language of Application English

Filing Date 2019-01-03

APPLICANT AND AGENT DETAILS

Applicant

SYLENTIS, S.A.U., Sociedad Anónima
Unipersonal, Joint stock company
Plaza del Descubridor Diego de Ordás, 3-5^o
E-28003 Madrid
SPAIN

Agent

ROBIC
630, boul. René-Lévesque Ouest, 20e étage,
Montréal, QUEBEC, H3B1S6

TRADEMARK DETAILS

DRINZYA

Trademark Type

Word

Goods

Class 05

Pharmaceutical preparations for the treatment of eye diseases and conditions; Pharmaceutical preparations for the prevention and treatment of ocular disorders or diseases; pharmaceutical preparations for the treatment of dry eye syndrome; pharmaceutical preparations for the prevention of dry eye syndrome; collyrium; ophthalmic preparations; medicated gels, creams and solutions for eye use for the prevention and treatment of ocular dryness, inflammation, irritation, pain and discomfort; medicated eye drops for the prevention and treatment of ocular dryness, inflammation, irritation, pain and discomfort; medicated eye lotions for the prevention and treatment of ocular dryness, inflammation, irritation, pain and discomfort; medicated eye sprays for the prevention and treatment of ocular dryness, inflammation, irritation, pain and discomfort; medicated eye ointment for the prevention and treatment of ocular dryness, inflammation, irritation, pain and discomfort.

Claims

Priority Filing Date: July 05, 2018, Country or Office: EUIPO (EU), Application No: 17927395 in association with the same kind of goods

Application Number 1,938,832
Language of Application English

Filing Date 2019-01-03

APPLICANT AND AGENT DETAILS

Applicant

SYLENTIS, S.A.U., Sociedad Anónima
Unipersonal, Joint stock company
Plaza del Descubridor Diego de Ordás, 3-5^o
E-28003 Madrid
SPAIN

Agent

ROBIC
630, boul. René-Lévesque Ouest, 20e étage,
Montréal, QUEBEC, H3B1S6

TRADEMARK DETAILS

ECIFYE

Trademark Type

Word

Goods

Class 05

Pharmaceutical preparations for the treatment of eye diseases and conditions; Pharmaceutical preparations for the prevention and treatment of ocular disorders or diseases; pharmaceutical preparations for the treatment of dry eye syndrome; pharmaceutical preparations for the prevention of dry eye syndrome; collyrium; ophthalmic preparations; medicated gels, creams and solutions for eye use for the prevention and treatment of ocular dryness, inflammation, irritation, pain and discomfort; medicated eye drops for the prevention and treatment of ocular dryness, inflammation, irritation, pain and discomfort; medicated eye lotions for the prevention and treatment of ocular dryness, inflammation, irritation, pain and discomfort; medicated eye sprays for the prevention and treatment of ocular dryness, inflammation, irritation, pain and discomfort; medicated eye ointment for the prevention and treatment of ocular dryness, inflammation, irritation, pain and discomfort.

Claims

Priority Filing Date: July 05, 2018, Country or Office: EUIPO (EU), Application No: 17927396 in association with the same kind of goods

Application Number 1,938,834
Language of Application English

Filing Date 2019-01-03

APPLICANT AND AGENT DETAILS

Applicant

Sunita Padda
255 East 1st Avenue
Vancouver
BRITISH COLUMBIA
V5T1A7

Agent

ALEXANDER HOLBURN BEAUDIN + LANG
LLP
P.O. BOX 10057, 2700 - 700 WEST GEORGIA
STREET, VANCOUVER, BRITISH
COLUMBIA, V7Y1B8

TRADEMARK DETAILS

MANNERS AND CO.

Trademark Type

Word

Disclaimer

The right to the exclusive use of the word MANNERS is disclaimed apart from the trademark.

Goods

Class 08

(1) cutlery

Class 16

(2) writing stationery, children's books, conversation cards designed to stimulate discussions /communication amongst individuals.

Class 21

(3) place mats of silicone

Class 24

(4) table cloth of textile, table napkins of textile

Services

Class 41

teaching etiquette to business persons, teaching of dining and social etiquette to children and adults

Application Number 1,938,850
Language of Application English

Filing Date 2019-01-03

APPLICANT AND AGENT DETAILS

Applicant

Lea Brand S.r.L.
Via Duca D'Aosta n.81
1-80045
Pompei (NA)
ITALY

Agent

GOWLING WLG (CANADA) LLP
SUITE 2600, 160 ELGIN STREET, OTTAWA,
ONTARIO, K1P1C3

TRADEMARK DETAILS

ELPLAYER

Trademark Type

Word

Foreign Character Translation

As provided by the applicant, "EL" is Spanish for "THE".

Goods

Class 09

(1) Eyewear of all types and parts thereof, namely sunglasses, eyeglasses, goggles for the practice of sports and for exercise; Lenses for eyeglasses, frames for eyeglasses, nose pieces pads for eyeglasses, eyewear cases; helmets for hockey

Class 14

(2) watches, sports chronographs for use as timepieces, stopwatches;

Class 18

(3) Casual bags; Handbags; Travel baggage; Beach bags; Fannypack; Haversacks; Leather purses; leather-ware, namely card wallets; leather goods, namely, briefcases; Leather credit card wallets; Wallets; Credit card holders made of leather; Key-cases of leather and skins; luggage, namely, trunks; Suitcases; Wheeled suitcases; Cosmetic bags sold empty; Sport bags; Wheeled luggage; School book bags; Travel garment covers; Shoe bags for travel; Nappy bags; Backpacks; Traveling trunks; Canvas shopping and travel bags; Business cases; Satchels; Vanity cases, not fitted; Worked or semi-worked hides and other leather; Leather shoulder belts; Umbrellas; leather lashes; Saddlery; Sports bags; backpacks; duffle bags; messenger bags; tote bags; gym bags; drawstring pouches; waist bags; kit bags; trunks (luggage) and suitcases; umbrellas; shoulder bags; accessories, namely, leather and imitations of leather; leather straps

Class 25

(4) Athletic clothing, Sportswear; Clothing for gymnastics; Suits; Bath-robos; Berets; Underwear; Suspenders; Leotards; Stockings; Socks; Breeches; Swimming trunks; Shirts; Sports singlets; Hats; Coats; Stuff jackets; Tights; Shoulder wraps; Headgear, namely hats, caps, sun visors, headbands, and head scarves; Swimming costumes; Beachwear; Neckties; Bathing caps; Scarves; Jackets; Fishing vests; Neck scarves, namely, mufflers, Skirts; Aprons; Gloves; Ski gloves; trousers, namely, Leggings; Maillots; Hosiery; Sweaters; Trousers; Mules; Parkas; Furs,

namely coats, hats, jackets, stoles, cloaks, and muffs; Pyjamas; Leg warmers; Sashes for wear; Shawls; Topcoats; Tee-shirts; Headwear, namely, Visors; Bath and beach robes; Menswear, namely shirts, jackets, pants, shorts, and suits; Rainproof clothing, namely coats, jackets, and boots; Children's wear; Leisurewear; Dance clothing; Clothing for skiing; Ladies' clothing, namely shirts, pants, dresses; Men's socks; Sports socks; Tank tops; Clothing for children; Wrist warmers; Sweatbands; Headbands, sweat-shirts; Kerchiefs; Foulards; Ca-goules; Track jackets; Polar fleece jackets; Sports jackets; Blousons; Gilets; Body warmers; Gym suits; Denim jeans; Kimonos; Running vests; Padded shirts for athletic use; Football jerseys; Warm-up tops; Morning coats; Wet suits for surfing; Gym shorts; Padded shorts for athletic use; Sweatpants; Ear muffs; Bowties; Bathing suit cover-ups; Polo shirts; Stiffeners for shoes in the nature of reinforced toe-puff for shoes; Jumper suits; Sport coats; Tightening-up strings for kimonos (datejime); Running Suits; Jogging sets; Snow suits; Twin sets; Belts; money Belts; Footwear, Sandals; Bath sandals; Shoes; Gymnastic shoes; Football boots; Training shoes; Ski boots; Beach shoes; Boots; Football boots; Studs for football boots; Footwear soles; Wooden shoes; Goloshes; Athletic footwear, shoes, soccer shoes, cleated shoes, apparel, namely, pants, shorts, shirts, t-shirts, pullovers, sweat shirts, sweat pants, jackets, socks, jerseys; Football shoes; cleats for attachment to sports shoes; apparel, namely, jerseys, pants, shorts, t-shirts, shirts, sweatshirts, hooded sweatshirts, hoods, sweatpants, vests, tank tops, warm-up suits, jackets, anoraks, coats, underwear, belts, sports bras, socks, wrist bands, headbands, hats, caps, visors, sweatbands, sweaters, skirts, dresses, scarves, gloves; athletic uniforms; athletic tights;

Class 28

(5) Soccer balls, balls for playing soccer, rugby and futbol, protective padding for playing sports, namely, shin guards, knee pads, and elbow pads; Sports equipment, namely, soccer balls, shin guards, protective padding for playing soccer; bags specially adapted for carrying sports equipment and sports balls; sporting goods, namely, ice skates, sports balls, bats, hockey sticks, hockey stick shafts, hockey stick blades, golf club head covers; sports mitts for baseball and softball, gloves for baseball, softball, golf, hockey, soccer, football and cycling; protective padding for football, soccer and hockey; protective hockey uniforms, namely, lower body suits with protective layers integral thereto; exercise equipment, namely, weight belts; weights used for exercise and training; Apparel for athletic use, namely padded shorts, padded pants, padded shirts, padded elbow compression sleeves; compression sleeves for athletic use; padded elbow compression sleeves sold as an integral component of athletic clothing, namely for jerseys or uniforms

Services

Class 35

Providing assistance in the management of franchised businesses; Provision of an on-line marketplace for buyers and sellers of goods and services; Retailing and wholesaling in relation to goods in the field of clothing, footwear, and accessories therefor, perfumery, cosmetics, spectacles, jewellery, clocks and watches, bags, umbrellas, gymnastic and sporting articles and equipment, balls, games, toys, playing cards; Providing retail outlets, wholesale stores, mail order catalogues services in the field of clothing, footwear, perfumery, cosmetics, spectacles, jewellery, clocks and watches, bags, umbrellas, gymnastic and sporting articles and equipment, balls, games, toys, playing cards via websites and television shopping programs; Retail and whole sale of clothing, footwear, and accessories therefor, perfumery, cosmetics, spectacles, jewellery, clocks and watches, bags, umbrellas, gymnastic and sporting articles and equipment, balls, games, toys, playing cards, electronic devices, telephones, smartwatches and covers therefor; Shop window dressing; Import and export services; Organisation of trade fairs for commercial or advertising

purposes, namely, arranging and conducting camping trade fairs and trade show exhibitions;
Provision of business administration assistance in the operation of franchises

Application Number 1,938,916
Language of Application English

Filing Date 2019-01-03

APPLICANT AND AGENT DETAILS

Applicant

Canada Royal Milk ULC
1680 Venture Drive
Kingston
ONTARIO
K7P0E9

Agent

BENNETT JONES LLP
4500 BANKERS HALL EAST, 855 - 2ND
STREET S.W., CALGARY, ALBERTA, T2P4K7

TRADEMARK DETAILS

Trademark Type

Design

Visual Representation

The logo for Cadeture features the word "Cadeture" in a serif font. A stylized leaf is positioned above the letter 'e', with its stem extending upwards and to the left, resembling a caduceus or a similar medical symbol.

Goods

Class 05

(1) Infant formula; Infant milk powder; Lacteal powder for infants; Infant food; Nutritional supplements for general health and well-being; Casein Protein dietary supplements; Protein powder dietary supplements; Vitamin preparations; Infant diapers; Dietary fiber to aid digestion.

Class 29

(2) Milk; Milk powder; Milk products; Edible fat and oil; Birds nest; Processed nuts, namely roasted nuts, blanched nuts, cooked nuts, and flavoured nuts; Soy milk (mainly milk); Yogurt; Goat milk; Goat yogurt.

Services

Class 35

Advertising flyer distribution; Sales demonstration for others; Advertising services for others; Sales demonstration via the internet for the retail sale of infant formula, infant milk powder, lacteal powder for infants, infant food, nutritional supplements for general health and well-being, protein powder dietary supplements, infant diapers, casein protein dietary supplements, vitamin preparations, dietary fiber to aid in digestion, milk, milk powder, milk products, edible fats and oil, birds nest, roasted nuts, soy milk (mainly milk), yogurt, goat milk, goat yogurt; Provide commercial information by website; Promoting the sale of goods and services of others through an online retail store relating to nutritional, infant foods, milk and milk products, and dietary supplements for general health and well-being; Providing online market for buyer and seller of goods and service; Providing advice and information relating to commercial business management.

Application Number 1,939,011
Language of Application English

Filing Date 2019-01-04

APPLICANT AND AGENT DETAILS

Applicant

PricewaterhouseCoopers LLP
18 York Street,
Suite 2600,
Toronto
ONTARIO
M5J0B2

Agent

MCMILLAN LLP
BROOKFIELD PLACE, SUITE 4400, BAY
WELLINGTON TOWER, 181 BAY STREET,
TORONTO, ONTARIO, M5J2T3

TRADEMARK DETAILS

Trademark Type

Design

Visual Representation



Colour Claim

Colour is claimed as a feature of the trade-mark. The words 'Your Brain on' appear in blue. The word 'Safety' and the head and umbrella designs appear in turquoise.

Goods

Class 09

(1) Downloadable electronic publications in the nature of news articles, books, booklets, brochures, journals, magazines, manuals, newsletters, newspapers, pamphlets and periodicals in the fields of learning, personal learning, corporate learning, coaching, training, management, business management, supervisory and interpersonal skills, leadership, organizational behaviour, and professional training, namely as the same relate to safety, safety techniques, safety strategies, safety processes, safety awareness, safety behaviour, safety skills development, and safety training

Class 16

(2) Printed materials, namely, news articles, books, booklets, brochures, journals, magazines, manuals, newsletters, newspapers, pamphlets and periodicals in the fields of learning, personal learning, corporate learning, coaching, training, management, business management, supervisory and interpersonal skills, leadership, organizational behaviour, and professional training, namely as the same relate to safety, safety techniques, safety strategies, safety processes, safety awareness, safety behaviour, safety skills development, and safety training

Services

Class 35

(1) Business management consulting

Class 41

(2) Providing non-downloadable electronic publications, namely, news articles, books, booklets, brochures, journals, magazines, manuals, newsletters, newspapers, pamphlets and periodicals in the fields of learning, personal learning, corporate learning, coaching, training, management, business management, supervisory and interpersonal skills, leadership, organizational behaviour, and professional training, namely, as the same relate to safety, safety techniques, safety strategies, safety processes, safety awareness, safety behaviour, safety skills development, and safety training via a website; training in the field of personal and workplace safety, namely, techniques, strategies, processes, awareness, behaviour, and skills development all related to personal and workplace safety

Class 45

(3) Consulting in the field of workplace safety

Application Number 1,939,064
Language of Application English

Filing Date 2019-01-04

APPLICANT AND AGENT DETAILS

Applicant

Market Track, LLC, Limited liability company
Delaware
24 E. Washington Street, Suite 1200
Chicago, IL 60602
UNITED STATES OF AMERICA

Agent

ROBIC
630, boul. René-Lévesque Ouest, 20e étage,
Montréal, QUEBEC, H3B1S6

TRADEMARK DETAILS

NUMERATOR

Trademark Type

Word

Goods

Class 09

Computer application software for mobile phones, handheld computers and tablets, namely, software for database management, providing a database and an on-line database in the field of transaction processing to upload transaction data, provide statistical analysis, and produce notifications and reports; Computer software for application and database integration, creating searchable databases of information and data, evaluating the effectiveness of advertisements in retailer circulars, the collection, editing, organizing, modifying, book marking, transmission, storage and sharing of data and information, and for researching sales and advertising trends and advertising effectiveness; Database management software for market assessment, analysis of market and marketing research data and statistics: Downloadable computer software that provides real-time, integrated business management intelligence by combining information from various databases and presenting it in an easy-to-understand user interface: Generating market reports and studies, conducting business market and marketing research, tracking consumer behavior and consumer trend analysis, tracking and reporting of retailer advertisements

Services

Class 35

(1) Advice and information about customer services and product management and prices on internet sites in connection with purchases made over the internet; Analysis of market and marketing research data and statistics; Analyzing and compiling business data; Business consultancy services, namely, competitive business analysis and monitoring of competitors' sales activities at all levels of distribution; Business consulting and information services in the field of business intelligence; Business information management; Business research and data analysis services in the field of retailing; Business research services, namely, tracking competitive advertising for others; Business services, namely, administration of a program for providing business intelligence services; Management and compilation of computerized databases; Systemization of information into computer databases; Collection of market and marketing research information; Compilation of statistics; Analysis of market research data and statistics; Statistical analysis and reporting services for business purposes; Computerized market and

marketing research services; Conducting business and market and marketing research surveys and studies for others; Consulting in the nature of analyzing and reporting sales activities at all levels of distribution; Consumer market and marketing research and consulting related thereto; Market and marketing analysis and research services; Market and marketing assessment services; Market and marketing reports and studies; Market and marketing research and business analyses, namely, business management analysis, business profit analysis, and strategic business analysis; Market and marketing research and market and marketing intelligence services; Market and marketing research by means of a computer database; Market and marketing research consultation, services and studies; Market and marketing segmentation consultation; Market and marketing study and analysis of market and marketing studies; Marketing and consulting services in the field of promoting and tracking the goods, services, and brands of others through all public communication means and in the field of conducting consumer tracking behavior research, consumer trend analysis and consumer market and marketing research; Online business research services that allow users to obtain market and marketing data, analysis, and reports; Preparation of business reports; Promoting, advertising and marketing the online databases and electronic publications of others; Providing an on-line computer database in the field of locating products, describing products, rating products, pricing products and comparing prices of products; Providing business, market and marketing intelligence services; Providing data analytics and business intelligence for marketing and management purposes; Providing market and marketing research services for others in the form of tracking and reporting advertisements placed by retailers in print, radio and television and on the internet in various markets; Providing pricing information about the goods and services of others via the global computer network; Providing market and marketing research information and market and marketing reports; Statistical analysis and reporting services for business purposes; Statistical evaluations of market and marketing data; Web based programs that provide business intelligence, namely, providing an online computer database in the field of promotional advertising information and associated reports and graphs; Web based subscription that allows users access to retail product and price intelligence

Class 42

(2) Brand protection services, namely, anti-counterfeiting consulting in the fields of brand monitoring and protection, to protect against counterfeiting, tampering, and diversion, and to ensure the integrity of genuine products and documents; Data mining services in the fields of price information and market availability, electronic data storage; Online computer services, namely, providing a search engine for obtaining information and data relating to intellectual property abuse and seller advertising violations from websites on a global computer network; Providing temporary use of on-line non-downloadable software for data analysis in the field of retailing and for researching sales and advertising trends and advertising effectiveness via a website; Providing online non-downloadable Internet-based system application featuring technology enabling users to research, analyze, and generate reports related to consumer market and marketing data; Providing online non-downloadable software for information and data collection, measurement, analytics and manipulation in the fields of market research, marketing research, market intelligence, marketing intelligence, business intelligence, business analytics and business reporting and for market research, marketing research and business intelligence; Providing software as a service (SAAS) featuring software for providing business, market and marketing analytics, competitive business analysis, information management, data management, information integration, business intelligence functions, monitoring, analyzing, and reporting on information available about other companies for business purposes, for analyzing business data for purposes of business intelligence analytics and reporting, for data analysis in the field of retail, and for the visual and analytic review of promotional, brand and e-commerce activity in a variety of media

types in the field of market and marketing research; Providing software research tool, namely, research in the field of software design; Providing temporary use of non-downloadable computer software for evaluating the effectiveness of all individual ad blocks within each retailer circular; Web based programs that provide business intelligence, namely, providing temporary use of online non-downloadable software to search and analyze promotional advertising information and associated reports and graphs; Web-based software application and user interface that provides real-time product information; Data feeds and API data integration tools, namely, computer systems integration services used to provide data sets to integrate with third party systems and client specific databases and software; Providing software application as a service that alert and provide insights for new product introductions and product lifecycle stages within the retail marketplace; Providing software application as a service that provides recommendations and workflow and action management tools in areas, namely adding products to a retailer's assortment, purchasing and placing advertising/media and search engine optimization within retailer sites; Providing software as a service that provides data and market estimates for sales-share and consumer demand across online retailers and for omni-channel; Providing software as a service for retailers to manage promotional advertising requests, approvals, placement, and production workflows from their brand supplier partners; Providing software as a service that incorporates consumer viewing habits and provide media targeting and advertising services to measure impact of advertising campaigns; Providing software as a service that analyzes consumer behavioral data and create prediction methods and engines that forecast or predict consumer behavior or impact

Claims

Priority Filing Date: July 06, 2018, Country or Office: UNITED STATES OF AMERICA, Application No: 88027996 in association with the same kind of goods and in association with the same kind of services

Application Number 1,939,066
Language of Application English

Filing Date 2019-01-04

APPLICANT AND AGENT DETAILS

Applicant

Market Track, LLC, Limited liability company
Delaware
24 E. Washington Street, Suite 1200
Chicago, IL 60602
UNITED STATES OF AMERICA

Agent

ROBIC
630, boul. René-Lévesque Ouest, 20e étage,
Montréal, QUEBEC, H3B1S6

TRADEMARK DETAILS

Trademark Type

Design

Visual Representation



Goods

Class 09

Computer application software for mobile phones, handheld computers and tablets, namely, software for database management, providing a database and an on-line database in the field of transaction processing to upload transaction data, provide statistical analysis, and produce notifications and reports; Computer software for application and database integration, creating searchable databases of information and data, evaluating the effectiveness of advertisements in retailer circulars, the collection, editing, organizing, modifying, book marking, transmission, storage and sharing of data and information, and for researching sales and advertising trends and advertising effectiveness; Database management software for market assessment, analysis of market and marketing research data and statistics: Downloadable computer software that provides real-time, integrated business management intelligence by combining information from various databases and presenting it in an easy-to-understand user interface: Generating market reports and studies, conducting business market and marketing research, tracking consumer behavior and consumer trend analysis, tracking and reporting of retailer advertisements

Services**Class 35**

(1) Advice and information about customer services and product management and prices on internet sites in connection with purchases made over the internet; Analysis of market and marketing research data and statistics; Analyzing and compiling business data; Business consultancy services, namely, competitive business analysis and monitoring of competitors' sales activities at all levels of distribution; Business consulting and information services in the field of business intelligence; Business information management; Business research and data analysis services in the field of retailing; Business research services, namely, tracking competitive advertising for others; Business services, namely, administration of a program for providing business intelligence services; Management and compilation of computerized databases; Systemization of information into computer databases; Collection of market and marketing research information; Compilation of statistics; Analysis of market research data and statistics; Statistical analysis and reporting services for business purposes; Computerized market and marketing research services; Conducting business and market and marketing research surveys and studies for others; Consulting in the nature of analyzing and reporting sales activities at all levels of distribution; Consumer market and marketing research and consulting related thereto; Market and marketing analysis and research services; Market and marketing assessment services; Market and marketing reports and studies; Market and marketing research and business analyses, namely, business management analysis, business profit analysis, and strategic business analysis; Market and marketing research and market and marketing intelligence services; Market and marketing research by means of a computer database; Market and marketing research consultation, services and studies; Market and marketing segmentation consultation; Market and marketing study and analysis of market and marketing studies; Marketing and consulting services in the field of promoting and tracking the goods, services, and brands of others through all public communication means and in the field of conducting consumer tracking behavior research, consumer trend analysis and consumer market and marketing research; Online business research services that allow users to obtain market and marketing data, analysis, and reports; Preparation of business reports; Promoting, advertising and marketing the online databases and electronic publications of others; Providing an on-line computer database in the field of locating products, describing products, rating products, pricing products and comparing prices of products; Providing business, market and marketing intelligence services; Providing data analytics and business intelligence for marketing and management purposes; Providing market and marketing research services for others in the form of tracking and reporting advertisements placed by retailers in print, radio and television and on the internet in various markets; Providing pricing information about the goods and services of others via the global computer network; Providing market and marketing research information and market and marketing reports; Statistical analysis and reporting services for business purposes; Statistical evaluations of market and marketing data; Web based programs that provide business intelligence, namely, providing an online computer database in the field of promotional advertising information and associated reports and graphs; Web based subscription that allows users access to retail product and price intelligence

Class 42

(2) Brand protection services, namely, anti-counterfeiting consulting in the fields of brand monitoring and protection, to protect against counterfeiting, tampering, and diversion, and to ensure the integrity of genuine products and documents; Data mining services in the fields of price information and market availability, electronic data storage; Online computer services, namely, providing a search engine for obtaining information and data relating to intellectual property abuse and seller advertising violations from websites on a global computer network; Providing temporary

use of on-line non-downloadable software for data analysis in the field of retailing and for researching sales and advertising trends and advertising effectiveness via a website; Providing online non-downloadable Internet-based system application featuring technology enabling users to research, analyze, and generate reports related to consumer market and marketing data; Providing online non-downloadable software for information and data collection, measurement, analytics and manipulation in the fields of market research, marketing research, market intelligence, marketing intelligence, business intelligence, business analytics and business reporting and for market research, marketing research and business intelligence; Providing software as a service (SAAS) featuring software for providing business, market and marketing analytics, competitive business analysis, information management, data management, information integration, business intelligence functions, monitoring, analyzing, and reporting on information available about other companies for business purposes, for analyzing business data for purposes of business intelligence analytics and reporting, for data analysis in the field of retail, and for the visual and analytic review of promotional, brand and e-commerce activity in a variety of media types in the field of market and marketing research; Providing software research tool, namely, research in the field of software design; Providing temporary use of non-downloadable computer software for evaluating the effectiveness of all individual ad blocks within each retailer circular; Web based programs that provide business intelligence, namely, providing temporary use of online non-downloadable software to search and analyze promotional advertising information and associated reports and graphs; Web-based software application and user interface that provides real-time product information; Data feeds and API data integration tools, namely, computer systems integration services used to provide data sets to integrate with third party systems and client specific databases and software; Providing software application as a service that alert and provide insights for new product introductions and product lifecycle stages within the retail marketplace; Providing software application as a service that provides recommendations and workflow and action management tools in areas, namely adding products to a retailer's assortment, purchasing and placing advertising/media and search engine optimization within retailer sites; Providing software as a service that provides data and market estimates for sales-share and consumer demand across online retailers and for omni-channel; Providing software as a service for retailers to manage promotional advertising requests, approvals, placement, and production workflows from their brand supplier partners; Providing software as a service that incorporates consumer viewing habits and provide media targeting and advertising services to measure impact of advertising campaigns; Providing software as a service that analyzes consumer behavioral data and create prediction methods and engines that forecast or predict consumer behavior or impact

Claims

Priority Filing Date: July 06, 2018, Country or Office: UNITED STATES OF AMERICA, Application No: 88028211 in association with the same kind of goods and in association with the same kind of services

Application Number 1,939,067
Language of Application English

Filing Date 2019-01-04

APPLICANT AND AGENT DETAILS

Applicant

Market Track, LLC, Limited liability company
Delaware
24 E. Washington Street, Suite 1200
Chicago, IL 60602
UNITED STATES OF AMERICA

Agent

ROBIC
630, boul. René-Lévesque Ouest, 20e étage,
Montréal, QUEBEC, H3B1S6

TRADEMARK DETAILS

Trademark Type

Design

Visual Representation



Goods

Class 09

Computer application software for mobile phones, handheld computers and tablets, namely, software for database management, providing a database and an on-line database in the field of transaction processing to upload transaction data, provide statistical analysis, and produce notifications and reports; Computer software for application and database integration, creating searchable databases of information and data, evaluating the effectiveness of advertisements in retailer circulars, the collection, editing, organizing, modifying, book marking, transmission, storage and sharing of data and information, and for researching sales and advertising trends and advertising effectiveness; Database management software for market assessment, analysis of market and marketing research data and statistics: Downloadable computer software that provides real-time, integrated business management intelligence by combining information from various databases and presenting it in an easy-to-understand user interface: Generating market reports and studies, conducting business market and marketing research, tracking consumer behavior and consumer trend analysis, tracking and reporting of retailer advertisements

Services

Class 35

(1) Advice and information about customer services and product management and prices on internet sites in connection with purchases made over the internet; Analysis of market and marketing research data and statistics; Analyzing and compiling business data; Business consultancy services, namely, competitive business analysis and monitoring of competitors' sales activities at all levels of distribution; Business consulting and information services in the field of business intelligence; Business information management; Business research and data analysis services in the field of retailing; Business research services, namely, tracking competitive advertising for others; Business services, namely, administration of a program for providing business intelligence services; Management and compilation of computerized databases;

Systemization of information into computer databases; Collection of market and marketing research information; Compilation of statistics; Analysis of market research data and statistics; Statistical analysis and reporting services for business purposes; Computerized market and marketing research services; Conducting business and market and marketing research surveys and studies for others; Consulting in the nature of analyzing and reporting sales activities at all levels of distribution; Consumer market and marketing research and consulting related thereto; Market and marketing analysis and research services; Market and marketing assessment services; Market and marketing reports and studies; Market and marketing research and business analyses, namely, business management analysis, business profit analysis, and strategic business analysis; Market and marketing research and market and marketing intelligence services; Market and marketing research by means of a computer database; Market and marketing research consultation, services and studies; Market and marketing segmentation consultation; Market and marketing study and analysis of market and marketing studies; Marketing and consulting services in the field of promoting and tracking the goods, services, and brands of others through all public communication means and in the field of conducting consumer tracking behavior research, consumer trend analysis and consumer market and marketing research; Online business research services that allow users to obtain market and marketing data, analysis, and reports; Preparation of business reports; Promoting, advertising and marketing the online databases and electronic publications of others; Providing an on-line computer database in the field of locating products, describing products, rating products, pricing products and comparing prices of products; Providing business, market and marketing intelligence services; Providing data analytics and business intelligence for marketing and management purposes; Providing market and marketing research services for others in the form of tracking and reporting advertisements placed by retailers in print, radio and television and on the internet in various markets; Providing pricing information about the goods and services of others via the global computer network; Providing market and marketing research information and market and marketing reports; Statistical analysis and reporting services for business purposes; Statistical evaluations of market and marketing data; Web based programs that provide business intelligence, namely, providing an online computer database in the field of promotional advertising information and associated reports and graphs; Web based subscription that allows users access to retail product and price intelligence

Class 42

(2) Brand protection services, namely, anti-counterfeiting consulting in the fields of brand monitoring and protection, to protect against counterfeiting, tampering, and diversion, and to ensure the integrity of genuine products and documents; Data mining services in the fields of price information and market availability, electronic data storage; Online computer services, namely, providing a search engine for obtaining information and data relating to intellectual property abuse and seller advertising violations from websites on a global computer network; Providing temporary use of on-line non-downloadable software for data analysis in the field of retailing and for researching sales and advertising trends and advertising effectiveness via a website; Providing online non-downloadable Internet-based system application featuring technology enabling users to research, analyze, and generate reports related to consumer market and marketing data; Providing online non-downloadable software for information and data collection, measurement, analytics and manipulation in the fields of market research, marketing research, market intelligence, marketing intelligence, business intelligence, business analytics and business reporting and for market research, marketing research and business intelligence; Providing software as a service (SAAS) featuring software for providing business, market and marketing analytics, competitive business analysis, information management, data management, information integration, business intelligence functions, monitoring, analyzing, and reporting on information

available about other companies for business purposes, for analyzing business data for purposes of business intelligence analytics and reporting, for data analysis in the field of retail, and for the visual and analytic review of promotional, brand and e-commerce activity in a variety of media types in the field of market and marketing research; Providing software research tool, namely, research in the field of software design; Providing temporary use of non-downloadable computer software for evaluating the effectiveness of all individual ad blocks within each retailer circular; Web based programs that provide business intelligence, namely, providing temporary use of online non-downloadable software to search and analyze promotional advertising information and associated reports and graphs; Web-based software application and user interface that provides real-time product information; Data feeds and API data integration tools, namely, computer systems integration services used to provide data sets to integrate with third party systems and client specific databases and software; Providing software application as a service that alert and provide insights for new product introductions and product lifecycle stages within the retail marketplace; Providing software application as a service that provides recommendations and workflow and action management tools in areas, namely adding products to a retailer's assortment, purchasing and placing advertising/media and search engine optimization within retailer sites; Providing software as a service that provides data and market estimates for sales-share and consumer demand across online retailers and for omni-channel; Providing software as a service for retailers to manage promotional advertising requests, approvals, placement, and production workflows from their brand supplier partners; Providing software as a service that incorporates consumer viewing habits and provide media targeting and advertising services to measure impact of advertising campaigns; Providing software as a service that analyzes consumer behavioral data and create prediction methods and engines that forecast or predict consumer behavior or impact

Claims

Priority Filing Date: July 06, 2018, Country or Office: UNITED STATES OF AMERICA, Application No: 88028203 in association with the same kind of goods and in association with the same kind of services

Application Number 1,939,068
Language of Application English

Filing Date 2019-01-04

APPLICANT AND AGENT DETAILS

Applicant

Market Track, LLC, Limited liability company
Delaware
24 E. Washington Street, Suite 1200
Chicago, IL 60602
UNITED STATES OF AMERICA

Agent

ROBIC
630, boul. René-Lévesque Ouest, 20e étage,
Montréal, QUEBEC, H3B1S6

TRADEMARK DETAILS

NUMERATOR EDGE

Trademark Type

Word

Goods

Class 09

Computer application software for mobile phones, handheld computers and tablets, namely, software for database management, providing a database and an on-line database in the field of transaction processing to upload transaction data, provide statistical analysis, and produce notifications and reports; Computer software for application and database integration, creating searchable databases of information and data, evaluating the effectiveness of advertisements in retailer circulars, the collection, editing, organizing, modifying, book marking, transmission, storage and sharing of data and information, and for researching sales and advertising trends and advertising effectiveness; Database management software for market assessment, analysis of market and marketing research data and statistics: Downloadable computer software that provides real-time, integrated business management intelligence by combining information from various databases and presenting it in an easy-to-understand user interface: Generating market reports and studies, conducting business market and marketing research, tracking consumer behavior and consumer trend analysis, tracking and reporting of retailer advertisements

Services

Class 35

(1) Advice and information about customer services and product management and prices on internet sites in connection with purchases made over the internet; Analysis of market and marketing research data and statistics; Analyzing and compiling business data; Business consultancy services, namely, competitive business analysis and monitoring of competitors' sales activities at all levels of distribution; Business consulting and information services in the field of business intelligence; Business information management; Business research and data analysis services in the field of retailing; Business research services, namely, tracking competitive advertising for others; Business services, namely, administration of a program for providing business intelligence services; Management and compilation of computerized databases; Systemization of information into computer databases; Collection of market and marketing research information; Compilation of statistics; Analysis of market research data and statistics; Statistical analysis and reporting services for business purposes; Computerized market and

marketing research services; Conducting business and market and marketing research surveys and studies for others; Consulting in the nature of analyzing and reporting sales activities at all levels of distribution; Consumer market and marketing research and consulting related thereto; Market and marketing analysis and research services; Market and marketing assessment services; Market and marketing reports and studies; Market and marketing research and business analyses, namely, business management analysis, business profit analysis, and strategic business analysis; Market and marketing research and market and marketing intelligence services; Market and marketing research by means of a computer database; Market and marketing research consultation, services and studies; Market and marketing segmentation consultation; Market and marketing study and analysis of market and marketing studies; Marketing and consulting services in the field of promoting and tracking the goods, services, and brands of others through all public communication means and in the field of conducting consumer tracking behavior research, consumer trend analysis and consumer market and marketing research; Online business research services that allow users to obtain market and marketing data, analysis, and reports; Preparation of business reports; Promoting, advertising and marketing the online databases and electronic publications of others; Providing an on-line computer database in the field of locating products, describing products, rating products, pricing products and comparing prices of products; Providing business, market and marketing intelligence services; Providing data analytics and business intelligence for marketing and management purposes; Providing market and marketing research services for others in the form of tracking and reporting advertisements placed by retailers in print, radio and television and on the internet in various markets; Providing pricing information about the goods and services of others via the global computer network; Providing market and marketing research information and market and marketing reports; Statistical analysis and reporting services for business purposes; Statistical evaluations of market and marketing data; Web based programs that provide business intelligence, namely, providing an online computer database in the field of promotional advertising information and associated reports and graphs; Web based subscription that allows users access to retail product and price intelligence

Class 42

(2) Brand protection services, namely, anti-counterfeiting consulting in the fields of brand monitoring and protection, to protect against counterfeiting, tampering, and diversion, and to ensure the integrity of genuine products and documents; Data mining services in the fields of price information and market availability, electronic data storage; Online computer services, namely, providing a search engine for obtaining information and data relating to intellectual property abuse and seller advertising violations from websites on a global computer network; Providing temporary use of on-line non-downloadable software for data analysis in the field of retailing and for researching sales and advertising trends and advertising effectiveness via a website; Providing online non-downloadable Internet-based system application featuring technology enabling users to research, analyze, and generate reports related to consumer market and marketing data; Providing online non-downloadable software for information and data collection, measurement, analytics and manipulation in the fields of market research, marketing research, market intelligence, marketing intelligence, business intelligence, business analytics and business reporting and for market research, marketing research and business intelligence; Providing software as a service (SAAS) featuring software for providing business, market and marketing analytics, competitive business analysis, information management, data management, information integration, business intelligence functions, monitoring, analyzing, and reporting on information available about other companies for business purposes, for analyzing business data for purposes of business intelligence analytics and reporting, for data analysis in the field of retail, and for the visual and analytic review of promotional, brand and e-commerce activity in a variety of media

types in the field of market and marketing research; Providing software research tool, namely, research in the field of software design; Providing temporary use of non-downloadable computer software for evaluating the effectiveness of all individual ad blocks within each retailer circular; Web based programs that provide business intelligence, namely, providing temporary use of online non-downloadable software to search and analyze promotional advertising information and associated reports and graphs; Web-based software application and user interface that provides real-time product information; Data feeds and API data integration tools, namely, computer systems integration services used to provide data sets to integrate with third party systems and client specific databases and software; Providing software application as a service that alert and provide insights for new product introductions and product lifecycle stages within the retail marketplace; Providing software application as a service that provides recommendations and workflow and action management tools in areas, namely adding products to a retailer's assortment, purchasing and placing advertising/media and search engine optimization within retailer sites; Providing software as a service that provides data and market estimates for sales-share and consumer demand across online retailers and for omni-channel; Providing software as a service for retailers to manage promotional advertising requests, approvals, placement, and production workflows from their brand supplier partners; Providing software as a service that incorporates consumer viewing habits and provide media targeting and advertising services to measure impact of advertising campaigns; Providing software as a service that analyzes consumer behavioral data and create prediction methods and engines that forecast or predict consumer behavior or impact

Claims

Priority Filing Date: July 06, 2018, Country or Office: UNITED STATES OF AMERICA, Application No: 88027994 in association with the same kind of goods and in association with the same kind of services

Application Number 1,939,070
Language of Application English

Filing Date 2019-01-04

APPLICANT AND AGENT DETAILS

Applicant

Market Track, LLC, Limited liability company
Delaware
24 E. Washington Street, Suite 1200
Chicago, IL 60602
UNITED STATES OF AMERICA

Agent

ROBIC
630, boul. René-Lévesque Ouest, 20e étage,
Montréal, QUEBEC, H3B1S6

TRADEMARK DETAILS

Trademark Type

Design

Visual Representation



Goods

Class 09

Computer application software for mobile phones, handheld computers and tablets, namely, software for database management, providing a database and an on-line database in the field of transaction processing to upload transaction data, provide statistical analysis, and produce notifications and reports; Computer software for application and database integration, creating searchable databases of information and data, evaluating the effectiveness of advertisements in retailer circulars, the collection, editing, organizing, modifying, book marking, transmission, storage and sharing of data and information, and for researching sales and advertising trends and advertising effectiveness; Database management software for market assessment, analysis of market and marketing research data and statistics: Downloadable computer software that provides real-time, integrated business management intelligence by combining information from various databases and presenting it in an easy-to-understand user interface: Generating market reports and studies, conducting business market and marketing research, tracking consumer behavior and consumer trend analysis, tracking and reporting of retailer advertisements

Services

Class 35

(1) Advice and information about customer services and product management and prices on internet sites in connection with purchases made over the internet; Analysis of market and marketing research data and statistics; Analyzing and compiling business data; Business consultancy services, namely, competitive business analysis and monitoring of competitors' sales activities at all levels of distribution; Business consulting and information services in the field of business intelligence; Business information management; Business research and data analysis services in the field of retailing; Business research services, namely, tracking competitive advertising for others; Business services, namely, administration of a program for providing business intelligence services; Management and compilation of computerized databases;

Systemization of information into computer databases; Collection of market and marketing research information; Compilation of statistics; Analysis of market research data and statistics; Statistical analysis and reporting services for business purposes; Computerized market and marketing research services; Conducting business and market and marketing research surveys and studies for others; Consulting in the nature of analyzing and reporting sales activities at all levels of distribution; Consumer market and marketing research and consulting related thereto; Market and marketing analysis and research services; Market and marketing assessment services; Market and marketing reports and studies; Market and marketing research and business analyses, namely, business management analysis, business profit analysis, and strategic business analysis; Market and marketing research and market and marketing intelligence services; Market and marketing research by means of a computer database; Market and marketing research consultation, services and studies; Market and marketing segmentation consultation; Market and marketing study and analysis of market and marketing studies; Marketing and consulting services in the field of promoting and tracking the goods, services, and brands of others through all public communication means and in the field of conducting consumer tracking behavior research, consumer trend analysis and consumer market and marketing research; Online business research services that allow users to obtain market and marketing data, analysis, and reports; Preparation of business reports; Promoting, advertising and marketing the online databases and electronic publications of others; Providing an on-line computer database in the field of locating products, describing products, rating products, pricing products and comparing prices of products; Providing business, market and marketing intelligence services; Providing data analytics and business intelligence for marketing and management purposes; Providing market and marketing research services for others in the form of tracking and reporting advertisements placed by retailers in print, radio and television and on the internet in various markets; Providing pricing information about the goods and services of others via the global computer network; Providing market and marketing research information and market and marketing reports; Statistical analysis and reporting services for business purposes; Statistical evaluations of market and marketing data; Web based programs that provide business intelligence, namely, providing an online computer database in the field of promotional advertising information and associated reports and graphs; Web based subscription that allows users access to retail product and price intelligence

Class 42

(2) Brand protection services, namely, anti-counterfeiting consulting in the fields of brand monitoring and protection, to protect against counterfeiting, tampering, and diversion, and to ensure the integrity of genuine products and documents; Data mining services in the fields of price information and market availability, electronic data storage; Online computer services, namely, providing a search engine for obtaining information and data relating to intellectual property abuse and seller advertising violations from websites on a global computer network; Providing temporary use of on-line non-downloadable software for data analysis in the field of retailing and for researching sales and advertising trends and advertising effectiveness via a website; Providing online non-downloadable Internet-based system application featuring technology enabling users to research, analyze, and generate reports related to consumer market and marketing data; Providing online non-downloadable software for information and data collection, measurement, analytics and manipulation in the fields of market research, marketing research, market intelligence, marketing intelligence, business intelligence, business analytics and business reporting and for market research, marketing research and business intelligence; Providing software as a service (SAAS) featuring software for providing business, market and marketing analytics, competitive business analysis, information management, data management, information integration, business intelligence functions, monitoring, analyzing, and reporting on information

available about other companies for business purposes, for analyzing business data for purposes of business intelligence analytics and reporting, for data analysis in the field of retail, and for the visual and analytic review of promotional, brand and e-commerce activity in a variety of media types in the field of market and marketing research; Providing software research tool, namely, research in the field of software design; Providing temporary use of non-downloadable computer software for evaluating the effectiveness of all individual ad blocks within each retailer circular; Web based programs that provide business intelligence, namely, providing temporary use of online non-downloadable software to search and analyze promotional advertising information and associated reports and graphs; Web-based software application and user interface that provides real-time product information; Data feeds and API data integration tools, namely, computer systems integration services used to provide data sets to integrate with third party systems and client specific databases and software; Providing software application as a service that alert and provide insights for new product introductions and product lifecycle stages within the retail marketplace; Providing software application as a service that provides recommendations and workflow and action management tools in areas, namely adding products to a retailer's assortment, purchasing and placing advertising/media and search engine optimization within retailer sites; Providing software as a service that provides data and market estimates for sales-share and consumer demand across online retailers and for omni-channel; Providing software as a service for retailers to manage promotional advertising requests, approvals, placement, and production workflows from their brand supplier partners; Providing software as a service that incorporates consumer viewing habits and provide media targeting and advertising services to measure impact of advertising campaigns; Providing software as a service that analyzes consumer behavioral data and create prediction methods and engines that forecast or predict consumer behavior or impact

Claims

Priority Filing Date: July 06, 2018, Country or Office: UNITED STATES OF AMERICA, Application No: 88028209 in association with the same kind of goods and in association with the same kind of services

Application Number 1,939,093
Language of Application English

Filing Date 2019-01-04

APPLICANT AND AGENT DETAILS

Applicant

Warmlyyours.Com, Inc.
590 Telser Rd.
Lake Zurich, IL 60047
UNITED STATES OF AMERICA

Agent

GOWLING WLG (CANADA) LLP
SUITE 2600, 160 ELGIN STREET, OTTAWA,
ONTARIO, K1P1C3

TRADEMARK DETAILS

Trademark Type

Design

Visual Representation



Goods

Class 11

radiant heating products and associated controls, namely, towel warmers, underfloor heating mats and cables, namely under floor heating installations; snow melting mats and cables, namely electric heating installations for walkways and driveways; roof and gutter melting cables, namely electric heating installations for roofs and gutters; countertop heating kits, namely, electric space heaters, electric radiant heaters

Services

Class 35

on-line retail store services featuring radiant heating products and associated controls namely, electric space heaters, electric radiant heaters, electric heating installations for walkways, driveways, floors, roofs, gutters; electric control circuits for electric heaters and electric heating installations

Claims

Priority Filing Date: September 19, 2018, Country or Office: UNITED STATES OF AMERICA, Application No: 88123368 in association with the same kind of goods and in association with the same kind of services

Application Number 1,939,141
Language of Application English

Filing Date 2019-01-04

APPLICANT AND AGENT DETAILS

Applicant

KOREA GINSENG CORP.
71, Beotkkot-gil, Daedeok-gu, Daejeon
REPUBLIC OF KOREA

Agent

NORTON ROSE FULBRIGHT CANADA LLP/S.
E.N.C.R.L.,S.R.L.
1, Place Ville Marie, Suite 2500, Montreal,
QUEBEC, H3B1R1

TRADEMARK DETAILS

Trademark Type

Design

Visual Representation



Colour Claim

Colour is claimed as a feature of the trade-mark. The mark consists of a two cables shown in gold connecting at the top to a white circle containing a red swirl on the left and a blue swirl on the right and at the bottom to two white cloud formations outlined in gold. Directly above the white cloud formation on each side are six gold stars. The shield inside the two cables is shown in white with the words 'SINCE 1899' shown in black. Directly under the word 'SINCE 1899' is a Korean Character that transliterates to 'cheong kwan jang' shown in black and a non-Latin character that translates to red ginseng shown in red. Below the shield and between the two cloud formations is the number '6' with a non-Latin character that translates to 'year old roots' shown in white. Below the number six is a red banner with gold trim featuring the words KOREAN RED GINSENG in white. The mark is shown on a red and black rectangular background.

Foreign Character Translation

The term 'cheong kwan jang' has no particular meaning and is a coined term. The English translation of the term 'hongsam' is 'red ginseng'. The English translation of the term 'nyeongeun' is 'year old roots'.

Foreign Character Transliteration

From top to bottom, the transliteration for the non-Latin characters are 'cheong kwan jang' 'hongsam' and 'nyeongeun'.

Goods**Class 29**

Frozen red ginseng for use as a vegetable; canned, pickled and steamed red ginseng for use as a vegetable; preserved red ginseng for use as a vegetable; red ginseng processed food products, namely, steamed and dried red ginseng for use as a vegetable; processed vegetable products containing red ginseng, namely, canned vegetables and pickled vegetables; vegetable juices for cooking; powdered eggs containing red ginseng; dairy-based food beverages, namely milk beverages containing fruits and red ginseng; dried edible seaweed containing red ginseng; preserved, frozen and dried fruits and vegetables containing red ginseng; prepared meals primarily consisting of cooked fruits and vegetables containing red ginseng

Application Number 1,939,142
Language of Application English

Filing Date 2019-01-04

APPLICANT AND AGENT DETAILS

Applicant

KOREA GINSENG CORP.
71, Beotkkot-gil, Daedeok-gu, Daejeon
REPUBLIC OF KOREA

Agent

NORTON ROSE FULBRIGHT CANADA LLP/S.
E.N.C.R.L.,S.R.L.
1, Place Ville Marie, Suite 2500, Montreal,
QUEBEC, H3B1R1

TRADEMARK DETAILS

Trademark Type

Design

Visual Representation



Colour Claim

Colour is claimed as a feature of the trade-mark. The mark consists of a two cables shown in gold connecting at the top to a white circle containing a red swirl on the left and a blue swirl on the right and at the bottom to two white cloud formations outlined in gold. Directly above the white cloud formation on each side are six gold stars. The shield inside the two cables is shown in white with the words 'SINCE 1899' shown in black. Directly under the word 'SINCE 1899' is a Korean Character that transliterates to 'cheong kwan jang' shown in black and a non-Latin character that translates to red ginseng shown in red. Below the shield and between the two cloud formations is the number '6' with a non-Latin character that translates to 'year old roots' shown in white. Below the number six is a red banner with gold trim featuring the words KOREAN RED GINSENG in white. The mark is shown on a red and black rectangular background.

Foreign Character Translation

The term 'cheong kwan jang' has no particular meaning and is a coined term. The English translation of the term 'hongsam' is 'red ginseng'. The English translation of the term 'nyeongeun' is 'year old roots'.

Foreign Character Transliteration

From top to bottom, the transliteration for the non-Latin characters are 'cheong kwan jang' 'hongsam' and 'nyeongeun'

Goods**Class 30**

(1) Cereal-based snack food containing red ginseng; flour for food containing red ginseng; candies containing red ginseng; red ginseng jellies for confectionery; ginseng tea; tea containing red ginseng; tea leaves for use as tea substitutes; red ginseng tea; coffee containing red ginseng; non-alcoholic tea-based beverages containing red ginseng; preparations made from cereals containing red ginseng, namely, cereal based energy bars and cereal based snack foods; chocolate products containing red ginseng, namely, chocolate bars, chocolate candies, chocolate chips and non-alcoholic chocolate-based beverages; red ginseng processed food products, namely, red ginseng teas and red ginseng royal jelly

Class 32

(2) Food products made from fruit containing red ginseng, namely, fruit-based food beverages

Application Number 1,939,162
Language of Application English

Filing Date 2019-01-04

APPLICANT DETAILS

Applicant

WILLIAM SILVER
6637 Quinpool Rd
Halifax
NOVA SCOTIA
B3L1B7

TRADEMARK DETAILS

TOP OF THE FOOD CHAIN

Trademark Type

Word

Goods

Class 25

Casual and athletic clothing; Hats

Services

Class 41

(1) Physical fitness instruction; Providing information in the world of physical fitness, specifically personal training, group training & workout plans via a website; Life coaching services in the fields of setting and achieving life goals, self-empowerment, self-esteem, self-confidence, and interpersonal communication

Class 44

(2) Consulting services in the field of nutrition

Application Number 1,939,168
Language of Application English

Filing Date 2019-01-04

APPLICANT AND AGENT DETAILS

Applicant

Liquid Home Ownership Inc.
830 - 1100 Melville Street
Vancouver
BRITISH COLUMBIA
V6E4A6

Agent

JANINE A. MACNEIL
(Fasken Martineau DuMoulin LLP), 2900 - 550
Burrard Street, Vancouver, BRITISH
COLUMBIA, V6C0A3

TRADEMARK DETAILS

Trademark Type

Design

Visual Representation



Services

Class 36

Financial services, namely, mortgage lending services; investment services, namely, investment of funds for others; shared equity-based financing and investment solutions in the nature of offering investment vehicles to allow the financing of real estate purchases by means of shared investment; shared equity-based financing and investment solutions in the nature of providing potential or current resident home owners down payment assistance or equity releasing products via funds raised through investment vehicles

Application Number 1,939,182
Language of Application English

Filing Date 2019-01-07

APPLICANT AND AGENT DETAILS

Applicant

Wilson Sporting Goods Co.
1 Prudential Plaza
130 East Randolph Street, Suite 600
Chicago, IL 60601
UNITED STATES OF AMERICA

Agent

MARKS & CLERK
33 Yonge Street, , Suite 300, Toronto,
ONTARIO, M5E1G4

TRADEMARK DETAILS

EVOSHIELD

Trademark Type

Word

Goods

Class 09

(1) Sunglasses, protective goggles for sports, eye shields for athletic use, eye shields specially adapted for protective sports helmets, sports eyewear, batter's helmets, protective padded or reinforced clothing for protection against bodily harm and blunt force trauma, protective sports helmet accessories that attach to the helmets, namely, chin straps; catchers' helmets, umpires' helmets, visors and masks specially adapted for such helmets; face shields for athletic use; face shields for sports helmets; protective face-shields for protective helmets; and mouth guards for sports.

Class 10

(2) Body limb compression sleeves for athletic use; compression sleeves for arms.

Class 18

(3) Sports bags, namely, backpacks, general purpose athletic bags for holding athletic equipment, sport travel bags, general purpose wheeled bags for holding sports equipment, duffel bags, sport umbrellas, all-purpose sports equipment bags and attache cases.

Class 25

(4) Shirts, tee shirts, sweat shirts, warm-up shirts, polo shirts, racerback shirts, tank tops, jerseys, hoodies, jackets, pullovers, pants, trousers, sweat pants, training pants, sliding pants, leggings, capris, shorts, short pants, belts, training shorts, sliding shorts, girdles, padded girdles, sports bras, socks, crew socks, hats, caps, bucket caps, headbands, visors being headwear, balaclavas, bandannas, wristbands as clothing, athletic uniforms; padded or reinforced clothing for athletic use, namely, padded shirts, padded pants, padded shorts; hand muffs; footwear, namely shoes, athletic shoes, athletic spiked shoes, gloves, mittens, and skirts.

Class 28

(5) Athletic protective equipment, namely, elbow guards, elbow guard straps, elbow protectors, wrist guards, wrist protectors, wrist guard straps, insertable knee, elbow, thigh, hip, back and chest pads, leg guards, leg guard straps, shin guards, chest protectors, chest guards, chest and back

guards, racerback chest guards, back guards, back protectors, back plates, athletic rib protectors, athletic thigh protectors, exercise leg protector, batting gloves, football gloves for receivers and linemen, multi-use athletic protective pads for baseball, softball, football and soccer, thumb guards, baseball and softball bat bags; catcher's protective kits comprised of chest protectors, leg guards and catcher's helmets for athletic use; shoulder pads and throat protectors for athletic use; and sports bags specifically designed to carry athletic equipment.

Application Number 1,939,258
Language of Application English

Filing Date 2019-01-07

APPLICANT AND AGENT DETAILS

Applicant

Andrew Peller Limited
697 South Service Road
Grimsby
ONTARIO
L3M4E8

Agent

RIDOUT & MAYBEE LLP
11 Holland Avenue, Suite 601 , Ottawa,
ONTARIO, K1Y4S1

TRADEMARK DETAILS

TINHORN CREEK

Trademark Type

Standard Characters

Goods

Class 33

wine, wine-based beverages

Services

Class 35

operation of a wine club, namely, selecting wines based on consumer expectations and arranging periodic shipment to club members;

Application Number 1,939,283
Language of Application English

Filing Date 2019-01-07

APPLICANT AND AGENT DETAILS

Applicant

LNRS Data Services Limited
Quadrant House, The Quadrant
Sutton, Surrey
SM2 5AS
UNITED KINGDOM

Agent

RIDOUT & MAYBEE LLP
11 Holland Avenue, Suite 601 , Ottawa,
ONTARIO, K1Y4S1

TRADEMARK DETAILS

CIRIUM

Trademark Type

Standard Characters

Services

Class 37

(1) provision of information electronically and over the internet and mobile wireless networks relating to the maintenance and repair of aircraft for the aviation industry, all of the aforementioned services directed to the aviation industry

Class 39

(2) provision of information electronically and over the internet and mobile wireless networks relating to air travel and air transport for the aviation industry, all of the aforementioned services directed to the aviation industry

Class 41

(3) provision of information electronically and over the internet and mobile wireless networks relating to airshows

Class 42

(4) provision of information electronically and over the internet and mobile wireless networks relating to aircraft technology, aerospace technology, and space technology, Software as a Service (SaaS) services featuring software for performing data analytics in the fields of aviation and travel, all of the aforementioned services directed to the aviation industry

Application Number 1,939,286
Language of Application English

Filing Date 2019-01-07

APPLICANT AND AGENT DETAILS

Applicant

ALFA GOMMA S.p.A.
Via Torri Bianche, 1
20871 Vimercate
ITALY

Agent

FASKEN MARTINEAU DUMOULIN LLP
Tour de la Bourse, Suite 3500, P.O. box 242,
800, Place Victoria, Montréal, QUEBEC,
H4Z1E9

TRADEMARK DETAILS

Trademark Type

Design

Visual Representation

ALFATRACTO

Goods

Class 06

(1) Pipe fittings and connections of metal.

Class 17

(2) Rubber sheets and rubber panels.

Claims

Priority Filing Date: December 11, 2018, Country or Office: ITALY, Application No: 017998260 in association with the same kind of goods

Application Number 1,939,312
Language of Application English

Filing Date 2019-01-07

APPLICANT AND AGENT DETAILS

Applicant

W-D Apparel Company, LLC
251 Little Falls Drive,
Wilmington, DE 19808
UNITED STATES OF AMERICA

Agent

MARKS & CLERK
33 Yonge Street, , Suite 300, Toronto,
ONTARIO, M5E1G4

TRADEMARK DETAILS

ENGINEERED TO MOVE

Trademark Type

Word

Goods

Class 25

(1) pants, shorts, jeans, shirts, jackets, coveralls

(2) aprons, boots, caps being headwear, work shoes and work boots, athletic footwear, casual footwear, gloves, hats, hooded tops, hooded jackets, hooded sweatshirts, hooded pullovers, bandanas, headscarves, toques, beanies, jacket liners, overalls, pajamas, shoes, skirts, socks, sweatpants, sweatshirts, t-shirts, underwear

Claims

Priority Filing Date: January 04, 2019, Country or Office: UNITED STATES OF AMERICA,
Application No: 88250276 in association with the same kind of goods (2)

Application Number 1,939,325
Language of Application English

Filing Date 2019-01-07

APPLICANT AND AGENT DETAILS

Applicant

CARLEN GONCALVES COSTA
9 Ailsa Place
#14
London
ONTARIO
N5Z4Z6

Agent

STACEY L. BOTHWELL
(SISKINDS LLP), 275 Dundas Street, Unit 1,
London, ONTARIO, N6B3L1

TRADEMARK DETAILS

Trademark Type

Design

Visual Representation

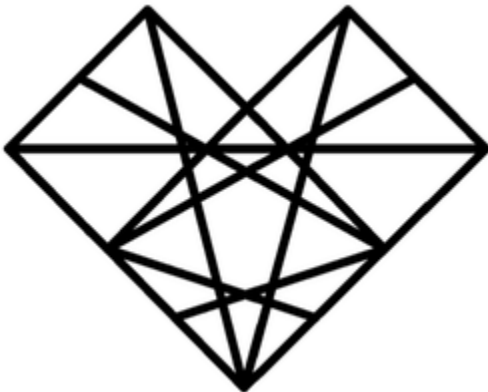

Goods

Class 03

(1) Non-medicated cosmetics in the form of body oils; beauty balm creams; beauty lotions; cosmetic creams and lotions; compacts containing make-up; solid powder for cosmetic compacts; aromatic oils for the bath; bath additives; bath beads; bath bombs; aromatic essential oils; essential oils for use as food flavourings; massage candles for cosmetic purposes; massage oils.

Class 05

(2) Dietary and nutritional supplements for general health and well being.

Class 09

(3) Stabilizers for smartphones; Stabilizers for smartphones with protective cases

Class 10

(4) Condoms; sex toys and sex dolls; electric vibrating massagers.

Class 14

(5) Jewellery, namely, bracelets, ankle bracelets, broaches, charms, chains, necklaces, pins, rings, earrings, key rings and key chains

Class 21

(6) Drinking glasses, namely wine glasses, cocktail glasses, martini glasses, rocks glasses, beer glasses, shot glasses; coffee cups, tea cups and mugs; travel mugs

Class 25

(7) Clothing, namely, short-sleeved and long-sleeved t-shirts, sweatshirts

(8) Clothing, namely, dresses, pants, sweatpants, yoga pants, shorts, skirts, blouses, jackets, sweaters and pajamas; women's underwear; women's lingerie; women's shoes

Class 28

(9) Board games; playing cards

Class 34

(10) Herbs for smoking; cannabis cigarettes; cannabis for smoking; cigarettes containing tobacco substitutes not for medical purposes; smoking pipes; cigarette rolling papers; cigarette filters; cigarette lighters; tobacco grinders; cannabis grinders; cigarette holders; tobacco holders.

Services**Class 41**

(1) Educational and entertainment services, namely production of audio and video programs about women's empowerment, women's health and sexual health; Educational services, namely providing online instruction seminars and workshops in the field of women's empowerment, women's health and sexual health.

(2) Educational and entertainment services, namely conducting classes, seminars, conferences, workshops, and retreats in the field of women's empowerment, women's health and sexual health

Class 44

(3) Counseling services in the fields of health, nutrition and lifestyle wellness; providing mental health and wellness information; consulting services in the fields of women's health and sexual health

Application Number 1,939,332
Language of Application English

Filing Date 2019-01-07

APPLICANT AND AGENT DETAILS

Applicant

Aristocrat Technologies Australia Pty Limited
Australia Building A, Pinnacle Office Park
85 Epping Road
North Ryde NSW 2113
AUSTRALIA

Agent

OSLER, HOSKIN & HARCOURT LLP
SUITE 1900, 340 ALBERT STREET,
OTTAWA, ONTARIO, K1R7Y6

TRADEMARK DETAILS

FAST FRANKIES ROARING JACKPOTS

Trademark Type

Word

Goods

Class 09

(1) Computer game software and computer software for use in operating gaming apparatus and gaming equipment namely electronic and electromechanical slot machines, electronic and electromechanical machines for video lottery games, video lottery terminals; software for playing slot and poker games; downloadable software featuring games and downloadable interactive entertainment software for gaming machines.

Class 28

(2) Gaming apparatus and equipment namely gaming machines for gambling and games involving gambling; gaming machines namely electronic and electromechanical slot machines and parts and fittings thereof.

Application Number 1,939,333
Language of Application English

Filing Date 2019-01-07

APPLICANT AND AGENT DETAILS

Applicant

Aristocrat Technologies Australia Pty Limited
Australia Building A, Pinnacle Office Park
85 Epping Road
North Ryde NSW 2113
AUSTRALIA

Agent

OSLER, HOSKIN & HARCOURT LLP
SUITE 1900, 340 ALBERT STREET,
OTTAWA, ONTARIO, K1R7Y6

TRADEMARK DETAILS

FLAMIN' HITS

Trademark Type

Word

Goods

Class 09

(1) Computer game software and computer software for use in operating gaming apparatus and gaming equipment namely electronic and electromechanical slot machines, electronic and electromechanical machines for video lottery games, video lottery terminals; software for playing slot and poker games; downloadable software featuring games and downloadable interactive entertainment software for gaming machines.

Class 28

(2) Gaming apparatus and equipment namely gaming machines for gambling and games involving gambling; gaming machines namely electronic and electromechanical slot machines and parts and fittings thereof.

Application Number 1,939,334
Language of Application English

Filing Date 2019-01-07

APPLICANT AND AGENT DETAILS

Applicant

Aristocrat Technologies Australia Pty Limited
Australia Building A, Pinnacle Office Park
85 Epping Road
North Ryde NSW 2113
AUSTRALIA

Agent

OSLER, HOSKIN & HARCOURT LLP
SUITE 1900, 340 ALBERT STREET,
OTTAWA, ONTARIO, K1R7Y6

TRADEMARK DETAILS

WILD LEPRE'COINS

Trademark Type

Word

Goods

Class 09

(1) Computer game software and computer software for use in operating gaming apparatus and gaming equipment namely electronic and electromechanical slot machines, electronic and electromechanical machines for video lottery games, video lottery terminals; software for playing slot and poker games; downloadable software featuring games and downloadable interactive entertainment software for gaming machines.

Class 28

(2) Gaming apparatus and equipment namely gaming machines for gambling and games involving gambling; gaming machines namely electronic and electromechanical slot machines and parts and fittings thereof.

Application Number 1,939,336
Language of Application English

Filing Date 2019-01-07

APPLICANT AND AGENT DETAILS

Applicant

Aristocrat Technologies Australia Pty Limited
Australia Building A, Pinnacle Office Park
85 Epping Road
North Ryde NSW 2113
AUSTRALIA

Agent

OSLER, HOSKIN & HARCOURT LLP
SUITE 1900, 340 ALBERT STREET,
OTTAWA, ONTARIO, K1R7Y6

TRADEMARK DETAILS

FORTUNES OF THE NILE

Trademark Type

Word

Goods

Class 09

(1) Computer game software and computer software for use in operating gaming apparatus and gaming equipment namely electronic and electromechanical slot machines, electronic and electromechanical machines for video lottery games, video lottery terminals; software for playing slot and poker games; downloadable software featuring games and downloadable interactive entertainment software for gaming machines.

Class 28

(2) Gaming apparatus and equipment namely gaming machines for gambling and games involving gambling; gaming machines namely electronic and electromechanical slot machines and parts and fittings thereof.

Application Number 1,939,337
Language of Application English

Filing Date 2019-01-07

APPLICANT AND AGENT DETAILS

Applicant

Aristocrat Technologies Australia Pty Limited
Australia Building A, Pinnacle Office Park
85 Epping Road
North Ryde NSW 2113
AUSTRALIA

Agent

OSLER, HOSKIN & HARCOURT LLP
SUITE 1900, 340 ALBERT STREET,
OTTAWA, ONTARIO, K1R7Y6

TRADEMARK DETAILS

WILD YUKON

Trademark Type

Word

Goods

Class 09

(1) Computer game software and computer software for use in operating gaming apparatus and gaming equipment namely electronic and electromechanical slot machines, electronic and electromechanical machines for video lottery games, video lottery terminals; software for playing slot and poker games; downloadable software featuring games and downloadable interactive entertainment software for gaming machines.

Class 28

(2) Gaming apparatus and equipment namely gaming machines for gambling and games involving gambling; gaming machines namely electronic and electromechanical slot machines and parts and fittings thereof.

Application Number 1,939,448
Language of Application English

Filing Date 2019-01-08

APPLICANT AND AGENT DETAILS

Applicant

Beam Suntory UK Limited
2 Longwalk Road, Stockley Park
Uxbridge, Middlesex UB11 1BA
UNITED KINGDOM

Agent

GOWLING WLG (CANADA) LLP
SUITE 2600, 160 ELGIN STREET, OTTAWA,
ONTARIO, K1P1C3

TRADEMARK DETAILS

GOLD REEF

Trademark Type

Word

Goods

Class 33

Alcoholic beverages, except beer, namely, whisky, gin, vodka, brandy, rum, cordials, liqueurs, spirits distilled from agave

Application Number 1,939,505
Language of Application English

Filing Date 2019-01-08

APPLICANT AND AGENT DETAILS

Applicant

Liberty Hardware Mfg. Corp.
140 Business Park Drive
Winston-Salem, NC 27107
UNITED STATES OF AMERICA

Agent

PIASETZKI NENNIGER KVAS LLP
SUITE 2308, 120 ADELAIDE STREET WEST,
TORONTO, ONTARIO, M5H1T1

TRADEMARK DETAILS

PAROW

Trademark Type

Word

Goods

Class 06

(1) Metal hardware, namely knobs and common metal pulls

Class 21

(2) Bathroom accessories, namely, toilet tissue holders, towel bars, towel rings

Claims

Priority Filing Date: July 20, 2018, Country or Office: UNITED STATES OF AMERICA, Application No: 88/045,918 in association with the same kind of goods

Application Number 1,939,536
Language of Application English

Filing Date 2019-01-08

APPLICANT AND AGENT DETAILS

Applicant

MASCO CANADA LIMITED
350 South Edgeware Road
St. Thomas
ONTARIO
N5P4L1

Agent

PIASETZKI NENNIGER KVAS LLP
SUITE 2308, 120 ADELAIDE STREET WEST,
TORONTO, ONTARIO, M5H1T1

TRADEMARK DETAILS

GRENVILLE

Trademark Type

Word

Goods

Class 11

Plumbing products, namely, faucets

Application Number 1,939,600
Language of Application English

Filing Date 2019-01-08

APPLICANT AND AGENT DETAILS

Applicant

August Rüggeberg GmbH & Co. KG
Hauptstraße 13
51709 Marienheide
GERMANY

Agent

MARKS & CLERK
180 Kent Street, Suite 1900, Ottawa,
ONTARIO, K1P0B6

TRADEMARK DETAILS

VICTOGRAIN

Trademark Type

Word

Goods

Class 07

(1) Machines for treatment of materials and for manufacturing, namely grinding machines for the treatment of steel material, steel cast iron, stainless steel, non-ferrous metal; machine tools for the treatment of materials and production, namely power operated steel working and metal working grinding tools; machine operated tools, namely power operated grinding tools for steel working and metal working; grinding machines for metalworking; rotary burrs for power operated grinders for use in metalworking; rotary burrs for power operated die grinders for use in metalworking; mounted points, fine grinding tools and polishing tools, diamond-pointed metal-cutting tools and cubic boron nitride (CBN) tools, grinding wheels and abrasive cut-off wheels, stationary abrasive cut-off wheels, technical brushes, all being parts of machines and poweroperated tools for metalworking; tool drives for metalworking machines, in particular pneumatic drives, electric drives and flexible shaft drives.

Class 08

(2) Hand-operated tools and implements, namely, files and rasps.

Claims

Priority Filing Date: July 11, 2018, Country or Office: EUIPO (EU), Application No: 017929430 in association with the same kind of goods

Application Number 1,939,631
Language of Application English

Filing Date 2019-01-08

APPLICANT AND AGENT DETAILS

Applicant

Strata Insights Inc.
600-3250 Bloor St W
Toronto
ONTARIO
M8X2X9

Agent

JENNIFER SANDER
200-140 Yonge St., Toronto, ONTARIO,
M5C1X6

TRADEMARK DETAILS

FINANCIAL BRAND MEASUREMENT

Trademark Type

Standard Characters

Goods

Class 09

(1) Electronic books, videos, and publications in the field of analyzing, assessing and calculating the financial contribution of brands; Software for inputting, updating, and accessing calculations of the financial contribution of a brand and the statistical analysis of underlying factors that affect the financial contribution growth or decline of a brand;

Class 16

(2) Printed books and publications in the field of analyzing, assessing and calculating the financial contribution of brands;

Services

Class 36

(1) Financial valuation of brands; Advisory & consultancy services relating to analyzing & assessing the financial value of brand efforts across a business and calculating brand return on investment (ROI); Advisory & consultancy services relating to analyzing, assessing and calculating the financial contribution of brands;

(2) Providing information in the field of analyzing, assessing and calculating the financial contribution of brands by way of a blog;

Class 41

(3) Providing in-person and online courses, workshops and seminars in the field of analyzing, assessing and calculating the financial contribution of brands;

Class 42

(4) Software as a service (SAAS) services featuring software for inputting, updating, and accessing calculations of the financial contribution of a brand and the statistical analysis of underlying factors that affect the financial contribution growth or decline of a brand;

Application Number 1,939,633
Language of Application English

Filing Date 2019-01-08

APPLICANT AND AGENT DETAILS

Applicant

Strata Insights Inc.
600-3250 Bloor St W
Toronto
ONTARIO
M8X2X9

Agent

JENNIFER SANDER
200-140 Yonge St., Toronto, ONTARIO,
M5C1X6

TRADEMARK DETAILS

BRAND ECONOMIST

Trademark Type

Standard Characters

Goods

Class 09

Software for inputting, updating, and accessing calculations of the financial contribution of a brand and the statistical analysis of underlying factors that affect the financial contribution growth or decline of a brand;

Services

Class 36

(1) Financial valuation of brands; Advisory & consultancy services relating to analyzing & assessing the financial value of brand efforts across a business and calculating brand return on investment (ROI); Advisory & consultancy services relating to analyzing, assessing and calculating the financial contribution of brands;

(2) Providing information in the field of analyzing, assessing and calculating the financial contribution of brands by way of a blog;

Class 41

(3) Providing in-person and online courses, workshops and seminars in the field of analyzing, assessing and calculating the financial contribution of brands;

Class 42

(4) Software as a service (SAAS) services featuring software for inputting, updating, and accessing calculations of the financial contribution of a brand and the statistical analysis of underlying factors that affect the financial contribution growth or decline of a brand;

Application Number 1,939,638
Language of Application English

Filing Date 2019-01-08

APPLICANT AND AGENT DETAILS

Applicant

Pariveda Solutions, Inc., a legal entity
2811 McKinney Ave., Suite 220
Dallas, TX 75204
UNITED STATES OF AMERICA

Agent

RICHES, MCKENZIE & HERBERT LLP
SUITE 1800, 2 BLOOR STREET EAST,
TORONTO, ONTARIO, M4W3J5

TRADEMARK DETAILS

Trademark Type

Design

Visual Representation



Services

Class 35

Business networking

Claims

Priority Filing Date: December 19, 2018, Country or Office: UNITED STATES OF AMERICA,
Application No: 88/235,221 in association with the same kind of services

Application Number 1,940,070
Language of Application English

Filing Date 2019-01-07

APPLICANT AND AGENT DETAILS

Applicant

Kautz Vineyards, Inc. DBA Ironstone Vineyards
1894 SIX MILE ROAD
MURPHYS, CALIFORNIA 95247
UNITED STATES OF AMERICA

Agent

ROBINSON SHEPPARD SHAPIRO S.E.N.C.R.
L./L.L.P.
STOCK EXCHANGE TOWER, 800 PLACE
VICTORIA, BUREAU 4600, MONTREAL,
QUEBEC, H4Z1H6

TRADEMARK DETAILS

Trademark Type

Design

Visual Representation



Colour Claim

Colour is claimed as a feature of the trademark. The mark consists of a brown stylized "M," beneath which appears the grey wording "MADDIE LANE VINEYARDS OLD VINE ZINFANDEL." To the upper right of the drawing is the grey numeral "2017." The entirety of the mark appears on a white background.

Goods

Class 33

Wine

Claims

Priority Filing Date: August 27, 2018, Country or Office: UNITED STATES OF AMERICA, Application No: 88/094,495 in association with the same kind of goods

Application Number 1,940,090
Language of Application English

Filing Date 2019-01-10

APPLICANT AND AGENT DETAILS

Applicant

National Council of State Boards of Nursing,
Inc.
Suite 2900, 111 East Wacker Drive
Chicago, IL 60601-4277
UNITED STATES OF AMERICA

Agent

OSLER, HOSKIN & HARCOURT LLP
SUITE 1900, 340 ALBERT STREET,
OTTAWA, ONTARIO, K1R7Y6

TRADEMARK DETAILS

Trademark Type

Design

Visual Representation



Goods

Class 09

(1) Electronic publications, namely, handbooks and manuals in the field of nursing licensure and nursing examinations, recorded on computer media.

Class 16

(2) Printed publications, namely, handbooks and manuals in the field of nursing licensure and nursing examinations; printed educational publications, namely, handbooks and manuals in the field of nursing licensure and nursing examinations.

Services

Class 41

(1) Educational services, namely, conducting classes, seminars, conferences, workshops and examinations in the field of nursing and distribution of course and examination materials in connection therewith in printed or electronic format; providing online publications, namely, handbooks and manuals in the field of nursing licensure and nursing examinations; providing educational resources, namely, non-downloadable electronic publications in the nature of handbooks and manuals in the field of nursing licensure and nursing examinations, via a website; online publication of electronic handbooks and manuals in the field of nursing licensure and nursing examinations.

Class 42

(2) Research in the field of nursing.

Class 44

(3) Consulting services in the field of nursing.

Claims

Priority Filing Date: July 30, 2018, Country or Office: UNITED STATES OF AMERICA, Application No: 88/057,942 in association with the same kind of goods and in association with the same kind of services

Application Number 1,940,120
Language of Application English

Filing Date 2019-01-10

APPLICANT AND AGENT DETAILS

Applicant

L'OREAL, société anonyme
14 rue Royale
75008 Paris
FRANCE

Agent

FASKEN MARTINEAU DUMOULIN LLP
Tour de la Bourse, Suite 3500, P.O. box 242,
800, Place Victoria, Montréal, QUEBEC,
H4Z1E9

TRADEMARK DETAILS

Trademark Type

Design

Visual Representation



Goods

Class 03

Perfumery; perfumes; toilet waters; eaux de cologne.

Claims

Priority Filing Date: July 18, 2018, Country or Office: FRANCE, Application No: 4469778 in association with the same kind of goods

Application Number 1,940,126
Language of Application English

Filing Date 2019-01-10

APPLICANT AND AGENT DETAILS

Applicant

L'OREAL, société anonyme
14 rue Royale
75008 Paris
FRANCE

Agent

FASKEN MARTINEAU DUMOULIN LLP
Tour de la Bourse, Suite 3500, P.O. box 242,
800, Place Victoria, Montréal, QUEBEC,
H4Z1E9

TRADEMARK DETAILS

Trademark Type

Design

Visual Representation



Goods

Class 03

Perfumery; perfumes; toilet waters; eaux de cologne.

Claims

Priority Filing Date: July 18, 2018, Country or Office: FRANCE, Application No: 4469776 in association with the same kind of goods

Application Number 1,940,248
Language of Application English

Filing Date 2019-01-11

APPLICANT AND AGENT DETAILS

Applicant

DSM IP Assets B.V.
Het Overloon 1
6411 TE HEERLEN
NETHERLANDS

Agent

SMART & BIGGAR LLP
SUITE 900, 55 METCALFE STREET, P.O.
BOX 2999, STATION D, OTTAWA, ONTARIO,
K1P5Y6

TRADEMARK DETAILS

PEFACLOT

Trademark Type

Word

Goods

Class 01

(1) Chemical products for use in industry and science, chemical substances for analyses in laboratories, chemical preparations for scientific purposes, and diagnostic preparations (other than for medical or veterinary use), all namely clinical diagnostic reagents, plasma activation agents used in testing for unfractionated heparin in patient plasma samples, and clinical diagnostic control samples for calibrating test kits for unfractionated heparin in patient plasma samples

Class 05

(2) Diagnostic preparations for medical purposes, namely clinical diagnostic reagents, plasma activation agents used in testing for unfractionated heparin in patient plasma samples, and clinical diagnostic control samples for calibrating test kits for unfractionated heparin in patient plasma samples

Class 10

(3) Diagnostic test kits used for medical analysis, namely test kits for monitoring unfractionated heparin in patient plasma samples

Claims

Priority Filing Date: July 11, 2018, Country or Office: EUIPO (EU), Application No: 017929440 in association with the same kind of goods

Application Number 1,940,250
Language of Application English

Filing Date 2019-01-11

APPLICANT AND AGENT DETAILS

Applicant

X-Technology Swiss GmbH
Samstagernstr. 45
8832 Wollerau
SWITZERLAND

Agent

AVENTUM IP LAW LLP
Suite 104, Tower A, 555 Legget Drive, Ottawa,
ONTARIO, K2K2X3

TRADEMARK DETAILS

HELIXCOIL

Trademark Type

Word

Goods

Class 10

(1) Elastic bandages, orthopaedic bandages for joints, orthopaedic shoes, orthopaedic soles for shoes, orthopaedic inserts for shoes

Class 23

(2) Yarns and threads for textile use

Class 25

(3) Clothing, namely, bandanas, shirts, slips, socks, undergarments, sports jerseys and tights, sports coats, sports shirts, coats, jackets, parkas, nightwear, bathing suits, clothing for children, namely, pants, shirts, body suits and hats for children, and gloves, underwear and stockings; Footwear, namely, casual and athletic footwear, climbing footwear, exercise footwear, footwear for track and field athletics, golf footwear, outdoor winter footwear, rain footwear, ski footwear, sports footwear; Headgear, namely, hats, caps, headbands, headscarves

Claims

Priority Filing Date: August 03, 2018, Country or Office: SWITZERLAND, Application No: 725825 in association with the same kind of goods

Application Number 1,940,265
Language of Application English

Filing Date 2019-01-11

APPLICANT AND AGENT DETAILS

Applicant

Kömmerling Chemische Fabrik GmbH
Zweibrücker Straße 200
66954 Pirmasens
GERMANY

Agent

ROBIC
630, boul. René-Lévesque Ouest, 20e étage,
Montréal, QUEBEC, H3B1S6

TRADEMARK DETAILS

4SG

Trademark Type

Word

Goods

Class 01

(1) Synthetic resin adhesives for industrial purposes.

Class 17

(2) Bonded seals, adhesive sealants and expansion joint fillers; Insulating and barrier materials namely insulating bands, insulating inks, insulating plaster, foils of metal for insulating, insulating felt, insulating refractory materials, insulating varnish, floating anti-pollution barriers, acoustical insulation barrier panels, laminated vapor barriers, polyurethane film for use as a moisture barrier; Thermoplastic spacers.

Claims

Priority Filing Date: July 31, 2018, Country or Office: EUIPO (EU), Application No: 017937876 in association with the same kind of goods

Application Number 1,940,274
Language of Application English

Filing Date 2019-01-11

APPLICANT AND AGENT DETAILS

Applicant

Apollo Property Management Limited
1200 Prince of Wales
Suite D
Ottawa
ONTARIO
K2C3Y4

Agent

MCMILLAN LLP
BROOKFIELD PLACE, SUITE 4400, BAY
WELLINGTON TOWER, 181 BAY STREET,
TORONTO, ONTARIO, M5J2T3

TRADEMARK DETAILS

Trademark Type
Design

Visual Representation



Services

Class 36

Providing information in the field of property management services, property listings for rent and lease and property rental application forms, all via a website; Property management services.

Application Number 1,940,276
Language of Application English

Filing Date 2019-01-11

APPLICANT AND AGENT DETAILS

Applicant

Apollo Property Management Limited
1200 Prince of Wales
Suite D
Ottawa
ONTARIO
K2C3Y4

Agent

MCMILLAN LLP
BROOKFIELD PLACE, SUITE 4400, BAY
WELLINGTON TOWER, 181 BAY STREET,
TORONTO, ONTARIO, M5J2T3

TRADEMARK DETAILS

Trademark Type

Design

Visual Representation



Services

Class 36

Providing information in the field of property management services, property listings for rent and lease and property rental application forms, all via a website; Property management services

Application Number 1,940,278
Language of Application English

Filing Date 2019-01-11

APPLICANT AND AGENT DETAILS

Applicant

Apollo Property Management Limited
1200 Prince of Wales
Suite D
Ottawa
ONTARIO
K2C3Y4

Agent

MCMILLAN LLP
BROOKFIELD PLACE, SUITE 4400, BAY
WELLINGTON TOWER, 181 BAY STREET,
TORONTO, ONTARIO, M5J2T3

TRADEMARK DETAILS

APOLLO PROPERTY MANAGEMENT

Trademark Type

Word

Services

Class 36

Providing information in the field of property management services, property listings for rent and lease and property rental application forms, all via a website; Property management services

Application Number 1,940,282
Language of Application English

Filing Date 2019-01-11

APPLICANT AND AGENT DETAILS

Applicant

Suntory Holdings Limited
1-40, Dojimahama 2-chome, Kita-ku, Osaka-
shi, Osaka 530-8203
JAPAN

Agent

GOWLING WLG (CANADA) LLP
SUITE 2600, 160 ELGIN STREET, OTTAWA,
ONTARIO, K1P1C3

TRADEMARK DETAILS

THE BLEND

Trademark Type

Word

Services

Class 41

(1) Entertainment services, namely, arranging and conducting of competitions, seminars and symposia in the field of alcoholic drinks; entertainment services, namely, alcoholic beverage cocktails tasting; educational services, namely, conducting classes, seminars, conferences, workshops in the field of alcoholic drinks and distribution of training materials in connection therewith; organization of exhibitions for cultural and educational purposes in the field of alcoholic beverages; club services in the field of alcoholic beverages, bartending and cocktail making

Class 43

(2) Providing information relating to restaurants, bars, pubs and cocktail lounges; providing information online and in organized events relating to bartending in the field of alcoholic beverages and food; bar and restaurant services; cocktail lounge services

Application Number 1,940,289
Language of Application English

Filing Date 2019-01-11

APPLICANT AND AGENT DETAILS

Applicant

Power Management Holdings (U.S.), Inc.
S45W29290 Highway 59
Waukesha, WI 53189
UNITED STATES OF AMERICA

Agent

AMY CROLL
(Origins IP), 1750 Courtwood Crescent, Suite
300, Ottawa, ONTARIO, K2C2B5

TRADEMARK DETAILS

ENBALA

Trademark Type

Word

Services

Class 35

(1) Business consulting and advisory services in the field of energy efficiency; Business consulting services and advisory services in the field of measurable and verifiable baselining, optimization, and predictions of utility use for industrial, commercial and residential buildings; Organizing and conducting exhibitions, tradeshow and forums in the field of energy and resource management for business purposes; Energy efficiency management, namely, providing electronic reporting of business information and analytics; Business consulting services in energy efficiency and energy and emissions management.

Class 42

(2) Software as a service (SAAS) services featuring software for the collection, analysis and management of data in the field of measurable and verifiable baselining, optimization, and predictions of utility use for industrial, commercial and residential buildings; Application service provider featuring software and software tools for use in the collection, analysis and management of data in the field of measurable and verifiable baselining, optimization, and predictions of utility use for industrial, commercial and residential buildings; Software as a service (SAAS) services featuring software for controlling hardware used for measurable and verifiable baselining, optimization, and predictions of utility use for industrial, commercial and residential buildings; Application service provider featuring software and software tools for controlling hardware used for measurable and verifiable baselining, optimization, and predictions of utility use for industrial, commercial and residential buildings; Software as a service (SAAS) services featuring software in the fields of energy efficiency and energy and emissions management; Consulting services in the field of energy efficiency for buildings; Consulting services in the field of measurable and verifiable baselining, optimization, and predictions of utility use for industrial, commercial and residential buildings; Energy efficiency consulting and information services; energy usage management consulting and information services being energy efficiency consultation services.

Application Number 1,940,291
Language of Application English

Filing Date 2019-01-11

APPLICANT AND AGENT DETAILS

Applicant

Power Management Holdings (U.S.), Inc.
S45W29290 Highway 59
Waukesha, WI 53189
UNITED STATES OF AMERICA

Agent

AMY CROLL
(Origins IP), 1750 Courtwood Crescent, Suite
300, Ottawa, ONTARIO, K2C2B5

TRADEMARK DETAILS

ENBALA POWER NETWORKS

Trademark Type

Word

Services

Class 35

(1) Business consulting and advisory services in the field of energy efficiency; Business consulting services and advisory services in the field of measurable and verifiable baselining, optimization, and predictions of utility use for industrial, commercial and residential buildings; Organizing and conducting exhibitions, tradeshow and forums in the field of energy and resource management for business purposes; Energy efficiency management, namely, providing electronic reporting of business information and analytics; Business consulting services in energy efficiency and energy and emissions management.

Class 42

(2) Software as a service (SAAS) services featuring software for the collection, analysis and management of data in the field of measurable and verifiable baselining, optimization, and predictions of utility use for industrial, commercial and residential buildings; Application service provider featuring software and software tools for use in the collection, analysis and management of data in the field of measurable and verifiable baselining, optimization, and predictions of utility use for industrial, commercial and residential buildings; Software as a service (SAAS) services featuring software for controlling hardware used for measurable and verifiable baselining, optimization, and predictions of utility use for industrial, commercial and residential buildings; Application service provider featuring software and software tools for controlling hardware used for measurable and verifiable baselining, optimization, and predictions of utility use for industrial, commercial and residential buildings; Software as a service (SAAS) services featuring software in the fields of energy efficiency and energy and emissions management; Consulting services in the field of energy efficiency for buildings; Consulting services in the field of measurable and verifiable baselining, optimization, and predictions of utility use for industrial, commercial and residential buildings; Energy efficiency consulting and information services; energy usage management consulting and information services being energy efficiency consultation services.

Application Number 1,940,364
Language of Application English

Filing Date 2019-01-11

APPLICANT AND AGENT DETAILS

Applicant

International Sanitary Supply Association, a
legal entity
10275 W. Higgins Road
Suite 280
Rosemont, IL
60018
UNITED STATES OF AMERICA

Agent

RICHES, MCKENZIE & HERBERT LLP
SUITE 1800, 2 BLOOR STREET EAST,
TORONTO, ONTARIO, M4W3J5

TRADEMARK DETAILS

Trademark Type

Design

Visual Representation



Services

Class 35

(1) arranging and conducting trade shows and exhibitions in the field of products, equipment and services for the commercial cleaning and building maintenance industry

(2) arranging and conducting trade shows and exhibitions in the field of products, equipment and services for the commercial cleaning and building maintenance industry

Class 41

(3) educational services, namely, conducting conferences in the field of business development; exhibitions for education purposes in the field of commercial cleaning and building maintenance industry; education services, namely, conducting workshops, seminars and classes in the field of commercial cleaning, maintenance and building services

(4) educational services, namely, conducting conferences in the field of business development; exhibitions for education purposes in the field of commercial cleaning and building maintenance industry; education services, namely, conducting workshops, seminars and classes in the field of commercial cleaning, maintenance and building services

Claims

Priority Filing Date: January 09, 2019, Country or Office: UNITED STATES OF AMERICA,
Application No: 88/255,205 in association with the same kind of services

Application Number 1,940,545
Language of Application English

Filing Date 2019-01-14

APPLICANT AND AGENT DETAILS

Applicant

Liquid Home Ownership Inc.
830 - 1100 Melville Street
Vancouver
BRITISH COLUMBIA
V6E4A6

Agent

JANINE A. MACNEIL
(Fasken Martineau DuMoulin LLP), 2900 - 550
Burrard Street, Vancouver, BRITISH
COLUMBIA, V6C0A3

TRADEMARK DETAILS

Trademark Type

Design

Visual Representation

The logo for Liquid Home Ownership. The word "Liquid" is written in a large, bold, sans-serif font. The letter "i" in "Liquid" has a unique design where the dot is a small circle. Below "Liquid", the words "HOME OWNERSHIP" are written in a smaller, all-caps, sans-serif font.

Services

Class 36

Financial services, namely, mortgage lending services; investment services, namely, investment of funds for others; shared equity-based financing and investment solutions in the nature of offering investment vehicles to allow the financing of real estate purchases by means of shared investment; shared equity-based financing and investment solutions in the nature of providing potential or current resident home owners down payment assistance or equity releasing products via funds raised through investment vehicles

Application Number 1,940,550
Language of Application English

Filing Date 2019-01-14

APPLICANT AND AGENT DETAILS

Applicant

Reliance Worldwide Corporation
2300 Defoor Hills Road NW
Atlanta, GA 30318
UNITED STATES OF AMERICA

Agent

OSLER, HOSKIN & HARCOURT LLP
SUITE 6200, P.O. BOX 50, 1 FIRST
CANADIAN PLACE, TORONTO, ONTARIO,
M5X1B8

TRADEMARK DETAILS

HOLDRITE

Trademark Type

Word

Goods

Class 06

(1) metal telescoping brackets for pipes, wires, cables and conduits; metal brackets and supports for pipes and electrical wires and conduits; metal clamps and hangers for pipes, wires, cables and conduit; extendable metal brackets for pipes, wires, cables and conduits; metal brackets for plumbing fixtures; metal plumbing straps; metal restraints for pipe joints and fittings; metal plenum supports; metal water heater supports, stands and sheds for water heaters; metal water heater straps and drain pans; metal suspension stands for water heaters; metal connectors for gas appliances; metal mounting brackets and straps for tanks; Metal plumbing fittings and accessories, namely, plumbing straps and brackets, and supports and restraints for plumbing pipes clamps, for pipes, wires, cables and conduit clamps, hangers and supports for pipes, wires, cables and conduit

Class 08

(2) plumbing wrenches

Class 17

(3) Non-metal firestop seals of intumescent material; non-metal firestop sleeves of intumescent material; vibration dampening plates for plumbing fittings and fixtures; non-metal acoustic isolators for plumbing fittings and accessories

Class 19

(4) non-metal firestop drains; non-metal, manually operated plumbing pressure testing and leak testing fittings for pipes; non-metal valves for leak or pressure test fittings for pipes; non-metal cleanout fittings; non-metal drain pans for appliances; Non-metal flanged firestop supports for tubes

Class 20

(5) acoustic dampening pipe clamps and hangers not made of metal; acoustic dampening plates, riser pads and liners not made of metal; vibration dampening clamps and hangers not made of metal for supporting pipes, wires, cables and conduit; non-metal clamps, brackets and supports for pipes, wires, cables and conduit; non-metal flame retardant clamps, hangers and supports for pipes, wires, cables and conduits; plastic clamps, brackets and supports for pipes, wires, cables and conduit

Claims

Priority Filing Date: January 11, 2019, Country or Office: UNITED STATES OF AMERICA,
Application No: 88/258,390 in association with the same kind of goods

Application Number 1,940,577
Language of Application English

Filing Date 2019-01-14

APPLICANT AND AGENT DETAILS

Applicant

9775919 Canada Inc.
2984 boul. St-Martin West
Laval
QUEBEC
H7T2J2

Agent

BORDEN LADNER GERVAIS LLP
ATTN: INTELLECTUAL PROPERTY
DEPARTMENT, 1000 DE LA GAUCHETIERE
STREET WEST, SUITE 900, MONTREAL,
QUEBEC, H3B5H4

TRADEMARK DETAILS

HAUS OF RTISTS MAGGIE SEMAAN

Trademark Type

Standard Characters

Foreign Character Translation

As provided by the applicant, translation of the term "HAUS" in English is "house".

Authorisation For Use

Consent from Maggie Semaan is of record.

Services

Class 41

(1) Hairdressing courses;

Class 44

(2) Beauty and hair salon services;

Application Number 1,940,814
Language of Application English

Filing Date 2019-01-15

APPLICANT AND AGENT DETAILS

Applicant

U.A.O.P. LUGGAGE INC.
271 Green Road
Stoney Creek
ONTARIO
L8E2A6

Agent

MICHELE BALLAGH
BLAZE IP, 102-175 Longwood Road South,
Hamilton, ONTARIO, L8P0A1

TRADEMARK DETAILS

AVANTE NOIR

Trademark Type

Word

Foreign Character Translation

The translation provided by the applicant of the Portuguese words AVANTE NOIR is FORWARD BLACK.

Goods

Class 18

(1) leather handbags, luggage and trunks, namely purses, wallets, change purses, camera bags, cosmetic bags, garment bags, golf bags, carry-all bags, drawstring bags, computer bags, overnight bags, suitcases, sports bags, wristlet handbags, clutch handbags, tote bags, duffle bags, hobo bags and backpacks; luggage tags;

Class 25

(2) clothing, namely t-shirts, shirts, sweatshirts, hoodies, pants, shorts and jackets; headwear, namely baseball caps, hats, toques and cowboy hats; footwear, namely casual shoes, athletic shoes, dress shoes and boots;

Services

Class 37

(1) luggage repair services; custom installation of automobile interiors;

Class 40

(2) luggage manufacturing services; custom manufacturing of automobile interiors;

Class 42

(3) luggage design services; custom design of automobile interiors;

Application Number 1,940,856
Language of Application English

Filing Date 2019-01-15

APPLICANT AND AGENT DETAILS

Applicant

Exxon Mobil Corporation
5959 Las Colinas Boulevard
Irving, TX 75039-2298
UNITED STATES OF AMERICA

Agent

RIDOUT & MAYBEE LLP
11 Holland Avenue, Suite 601 , Ottawa,
ONTARIO, K1Y4S1

TRADEMARK DETAILS

PLASTOL

Trademark Type

Standard Characters

Goods

Class 04

white process oils used as extenders in the manufacture of elastomers and adhesives

Application Number 1,940,935
Language of Application English

Filing Date 2019-01-15

APPLICANT AND AGENT DETAILS

Applicant

Da Hong Pao Noodle House Inc.
28-174 Colonnade Road
Ottawa
ONTARIO
K2E7J5

Agent

YUE FAN
(Joy Fan Trademark Services & IP Consulting),
137-1140 Burnhamthorpe Road West, Suite
#115, Mississauga, ONTARIO, L5C0A3

TRADEMARK DETAILS

NOODLE'S INVITATION

Trademark Type

Word

Goods

Class 16

(1) Brochures, coupons, flyers, gift cards, printed restaurant menus, pamphlets.

Class 29

(2) Cooked dish consisting primarily of stir-fried pork, beef, chicken, seafood and vegetable; cold dish consisting primarily of cooked meats, chicken and vegetables; soups; pickled vegetables; Chinese sausages.

Class 30

(3) Noodles, dried noodles, Chinese noodle soup, Chinese rice noodles; cooked rice; pancakes; sauce mixes, hot chili sauces; vermicelli; Chinese steamed dumplings, Chinese stuffed dumplings, wonton.

Services

Class 43

Restaurants; restaurant services, take-out restaurant services; catering services; operation of restaurants, take-out restaurants and snack bars; providing information in the field of restaurant services via a website featuring menus, promotional events, locations and social media connections of the Applicant's restaurant.

Application Number 1,940,981
Language of Application English

Filing Date 2019-01-16

APPLICANT AND AGENT DETAILS

Applicant
ELECTROLUX HOME PRODUCTS, INC.
10200 David Taylor Drive
Legal Department
Charlotte, NC 28262
UNITED STATES OF AMERICA

Agent
MILLER IP LAW
84 Neilson Drive, Toronto, ONTARIO, M9C1V7

TRADEMARK DETAILS

PureAir Ultra II

Trademark Type
Word

Goods

Class 11

Refrigerators, freezers, combinations thereof, and components thereof, namely air filtration systems comprised of air filters for refrigerators, freezers, combinations thereof

Claims

Priority Filing Date: January 15, 2019, Country or Office: UNITED STATES OF AMERICA, Application No: 88/262,581 in association with the same kind of goods

Application Number 1,941,127
Language of Application English

Filing Date 2019-01-16

APPLICANT AND AGENT DETAILS

Applicant

Above and Beyond - Business Tools and
Services For Entrepreneurs, Inc.
902 Carnegie Center, Suite 160
Princeton, NJ 08540
UNITED STATES OF AMERICA

Agent

GOWLING WLG (CANADA) LLP
SUITE 1600, 1 FIRST CANADIAN PLACE, 100
KING STREET WEST, TORONTO, ONTARIO,
M5X1G5

TRADEMARK DETAILS

GET BEYOND

Trademark Type

Standard Characters

Services

Class 35

(1) Payroll processing services; human resources support, outsourcing, auditing, management, and consultancy; customer service management for others; administration of employee benefit plans; employee record management for others.

Class 36

(2) Financial services, namely, credit card, debit card, bank card, smart card, prepaid card, stored value card, and in store, smart phone, online, and mobile device payment accounts transaction processing services; credit card, debit card, bank card, smart card, prepaid card, stored value card, and in store, smart phone, online, and mobile device payment accounts verification services; check verification and processing services; credit card, debit card, bank card, smart card, prepaid card, stored value card, and in store, smart phone, online, and mobile device payment accounts authorization services; electronic payment services involving electronic processing and subsequent transmission of bill payment data; providing electronic processing of credit card, debit card, bank card, smart card, prepaid card, stored value card, and in store, smart phone, online, and mobile device payment accounts transactions via a proprietary and secure financial global computer network; credit card, debit card, bank card, smart card, prepaid card, stored value card, and prepaid payment card account services featuring a computer readable card; electronic funds transfer services; payroll tax debiting services; providing online financial services to retail merchants, namely, providing financial account management services and financial clearance services in the nature of clearing and reconciling financial transactions for retail establishments; clearing and reconciling financial transactions via a global computer network; providing account transaction information to merchants, namely, credit card, debit card, bank card, smart card, prepaid card, stored value card, and in store, smart phone, online, and mobile device payment accounts transactions information and balances via a secure Internet website; information, advisory, and consultancy services related to credit card, debit card, bank card, smart card, prepaid card, stored value card, and in store, smart phone, online, and mobile device payment accounts transaction processing services; information, advisory, and consultancy services related to credit card, debit card, bank card, smart card, prepaid card, stored value card, and in store,

smart phone, online, and mobile device payment accounts transaction processing practices for retail establishments; financial transaction services, namely, providing secure commercial transactions and payment options using a mobile device at a point of sale; loyalty program payment processing services; information services, namely, financial information provided to customers for business analysis in the field of employee payroll and regulatory compliance provided via a website, the Internet, and computer network; commercial lending services; business lending services; small business lending services.

Class 42

(3) Cloud-based software as a service and platform as a service for use as a spreadsheet, for word processing, for database management, for use in the electronic storage, management, and reporting of data and for allowing operators and users to interact using tablet computers, remote computers, mobile devices, and POS (point of sale) terminals, for production planning and management relating to restaurants, distributorships, retail order fulfillment, and production flow, for providing point of sale payment services, for providing custom alerts, and for providing statistical reports related to business management, operation, sales, sales per man-hour, and labor costs; cloud-based software as a service and computer platform as a service for providing online access to a web-based restaurant, distributorship, and retail management computer system and online portal for providing restaurant management, retail management, distributorship management and records management, and for point of sale functions, back office solutions, enterprise management, mobile, kiosk, and web ordering, inventory management, recipe management, daybook and manager log management, labor scheduling, time attendance functions, tip management, conversational ordering, suggestive selling, customer facing displays, barcode scanning, incoming caller ID, digital signage, omni-channel ordering, guest management, gift and stored value card management, loyalty services, voice recognition, machine learning, offline ordering and payment functionality, cloud based disaster recovery, remote configuration, service time metrics, delivery management, money and deposit management, tax configuration and management, and for providing a dashboard with full reporting of data analytics and a development platform and application programming interface for the creation of custom mobile applications.

Class 45

(4) Tracking and monitoring regulatory requirements for employees in the field of federal, state, and local tax compliance as well as the reporting of new employee hiring for regulatory compliance purposes.

Claims

Priority Filing Date: August 14, 2018, Country or Office: UNITED STATES OF AMERICA, Application No: 88/077,916 in association with the same kind of services (1), (4); August 14, 2018, Country or Office: UNITED STATES OF AMERICA, Application No: 88/077,920 in association with the same kind of services (3); August 14, 2018, Country or Office: UNITED STATES OF AMERICA, Application No: 88/077,917 in association with the same kind of services (2)

Application Number 1,941,236
Language of Application English

Filing Date 2019-01-17

APPLICANT AND AGENT DETAILS

Applicant

Medeca Pharma AB
Rapskatan 7A
754 50 UPPSALA
SWEDEN

Agent

BERESKIN & PARR LLP/S.E.N.C.R.L., S.R.L.
SCOTIA PLAZA, 40 KING STREET WEST,
40th FLOOR, TORONTO, ONTARIO, M5H3Y2

TRADEMARK DETAILS

EMERADE

Trademark Type

Standard Characters

Goods

Class 05

(1) preparations for human use in the form of injection liquids for the treatment of allergy, available on prescription only

Class 10

(2) medical apparatus and instruments for injection purposes, namely auto-injectors and syringes containing preparations for human use in the form of injection liquids for the treatment of allergy

Application Number 1,941,243
Language of Application English

Filing Date 2019-01-17

APPLICANT AND AGENT DETAILS

Applicant

Société des Produits Nestlé S.A.
Case Postale 353
1800 Vevey
SWITZERLAND

Agent

BORDEN LADNER GERVAIS LLP
World Exchange Plaza, 100 Queen Street,
Suite 1300, Ottawa, ONTARIO, K1P1J9

TRADEMARK DETAILS

PERT-FREE

Trademark Type

Standard Characters

Goods

Class 05

Nutritional supplement in the nature of a nutrient-dense, protein, soy protein or whey based ready-to-drink beverage for general health and well-being; nutritional supplement meal replacement bars containing vitamins and minerals and nutritional supplement meal replacement bars for boosting energy.

Claims

Priority Filing Date: July 20, 2018, Country or Office: UNITED STATES OF AMERICA, Application No: 88/046,449 in association with the same kind of goods

Application Number 1,941,246
Language of Application English

Filing Date 2019-01-17

APPLICANT AND AGENT DETAILS

Applicant

Lianne Kim, doing business as, Think Big
Consulting
175 Ferris Rd.
Toronto
ONTARIO
M4B1H1

Agent

CYNTHIA D. MASON
(Mason Professional Corporation), 1000
Innovation Drive, Suite 500, Kanata,
ONTARIO, K2K3E7

TRADEMARK DETAILS

THE DREAM CLIENT FORMULA

Trademark Type

Word

Goods

Class 09

(1) Downloadable videos and electronic books in the fields of sales, marketing and business development

Class 16

(2) Work books

Services

Class 41

(1) Education services in the fields of sales, marketing and business development; online educational courses in the fields of sales, marketing and business development

Class 45

(2) Online social networking services; online social networking services featuring online communities for registered users to post and interact with others on topics in the fields of sales, marketing and business development

Application Number 1,941,247
Language of Application English

Filing Date 2019-01-17

APPLICANT AND AGENT DETAILS

Applicant

Lianne Kim, doing business as, Think Big Consulting
175 Ferris Rd.
Toronto
ONTARIO
M4B1H1

Agent

CYNTHIA D. MASON
(Mason Professional Corporation), 1000
Innovation Drive, Suite 500, Kanata,
ONTARIO, K2K3E7

TRADEMARK DETAILS

PROFIT & PROSPER

Trademark Type

Word

Goods

Class 09

(1) Downloadable videos and electronic books in the fields of business finances, money management and business planning and development

Class 16

(2) Work books

Services

Class 41

(1) Education services in the fields of business finances, money management and business planning and development; online educational courses in the fields of business finances, money management and business planning and development

Class 45

(2) Online social networking services; online social networking services featuring online communities for registered users to post and interact with others on topics in the fields of business finances, money management and business planning and development

Application Number 1,941,248
Language of Application English

Filing Date 2019-01-17

APPLICANT AND AGENT DETAILS

Applicant

Lianne Kim, doing business as, Think Big
Consulting
175 Ferris Rd.
Toronto
ONTARIO
M4B1H1

Agent

CYNTHIA D. MASON
(Mason Professional Corporation), 1000
Innovation Drive, Suite 500, Kanata,
ONTARIO, K2K3E7

TRADEMARK DETAILS

THE BUSINESS OF THINKING BIG

Trademark Type

Word

Goods

Class 09

(1) Digital sound recordings featuring information related to business financing, money management, and business planning and development; downloadable digital media, namely podcasts in the fields of business financing, money management, and business planning and development

(2) Downloadable videos and electronic books in the fields of business finances, money management, and business planning and development

Class 16

(3) Work books

Services

Class 38

(1) Podcasting of business information shows and interviews

Class 41

(2) Education services in the fields of business finances, money management, and business forecasting; online educational courses in the fields of business finances, money management, and business forecasting

Class 45

(3) Online social networking services; online social networking services featuring online communities for registered users to post and interact with others on topics in the fields of business finances, money management, and business planning and development

Application Number 1,941,257
Language of Application English

Filing Date 2019-01-17

APPLICANT AND AGENT DETAILS

Applicant

Rhythm Band Instruments, LLC
P.O. Box 165117
Fort Worth, TX 76161-5117
UNITED STATES OF AMERICA

Agent

SMART & BIGGAR LLP
SUITE 900, 55 METCALFE STREET, P.O.
BOX 2999, STATION D, OTTAWA, ONTARIO,
K1P5Y6

TRADEMARK DETAILS

CHROMA-NOTES

Trademark Type

Word

Goods

Class 15

(1) Musical instruments, namely, percussion instruments, bells, chimes, glockenspiels;

Class 16

(2) Stickers

Claims

Priority Filing Date: January 04, 2019, Country or Office: UNITED STATES OF AMERICA,
Application No: 88/249,795 in association with the same kind of goods

Application Number 1,941,333
Language of Application English

Filing Date 2019-01-17

APPLICANT AND AGENT DETAILS

Applicant

Odenwald Faserplattenwerk GmbH, a legal
entity
Dr. -F.-A.-Freundt-Straße 3
63916 Amorbach
GERMANY

Agent

RICHEs, MCKENZIE & HERBERT LLP
SUITE 1800, 2 BLOOR STREET EAST,
TORONTO, ONTARIO, M4W3J5

TRADEMARK DETAILS

COSMOS

Trademark Type

Word

Goods

Class 19

fibreboards for use in the construction of suspended ceilings

Claims

Priority Filing Date: July 31, 2018, Country or Office: EUIPO (EU), Application No: 017938096 in
association with the same kind of goods

Application Number 1,941,334
Language of Application English

Filing Date 2019-01-17

APPLICANT AND AGENT DETAILS

Applicant

Odenwald Faserplattenwerk GmbH, a legal entity
Dr. -F.-A.-Freundt-Straße 3
63916 Amorbach
GERMANY

Agent

RICHEs, MCKENZIE & HERBERT LLP
SUITE 1800, 2 BLOOR STREET EAST,
TORONTO, ONTARIO, M4W3J5

TRADEMARK DETAILS

SINFONIA

Trademark Type

Word

Goods

Class 19

fibrebboards for use in the construction of suspended ceilings

Claims

Priority Filing Date: July 31, 2018, Country or Office: EUIPO (EU), Application No: 017938091 in association with the same kind of goods

Application Number 1,941,526
Language of Application English

Filing Date 2019-01-18

APPLICANT AND AGENT DETAILS

Applicant

Roivant Sciences GmbH
Viaduktstrasse 8
4051 Basel
SWITZERLAND

Agent

GOWLING WLG (CANADA) LLP
SUITE 2600, 160 ELGIN STREET, OTTAWA,
ONTARIO, K1P1C3

TRADEMARK DETAILS

INFLAVANT

Trademark Type

Word

Goods

Class 05

Pharmaceutical preparations for human use for the treatment of inflammatory and inflammatory-related diseases, disorders and conditions, namely, arthritis, rheumatoid arthritis, inflammatory bowel diseases, inflammatory connective tissue diseases, vasculitis, synovitis, and inflammatory-related pain; biologic preparations for medical and therapeutic purposes for the treatment of inflammatory and inflammatory-related diseases, disorders and conditions, namely, arthritis, rheumatoid arthritis, inflammatory bowel diseases, inflammatory connective tissue diseases, vasculitis, synovitis, and inflammatory-related pain.

Services

Class 42

(1) Scientific and technological services and research and design relating thereto, namely, medical research, scientific research and analysis in the fields of inflammatory and inflammatory-related diseases, disorders and conditions, pharmaceuticals, biomedicine, clinical trials and post-market trials; pharmaceutical, biomedical and biological therapeutic research services; research in the fields of pharmaceutical and biologic therapeutic preparations, clinical trials and post-market trials; pharmaceutical research and development; providing scientific research information in the fields of pharmaceuticals, biomedicine, clinical trials and postmarket trials.

Class 44

(2) Providing health and medical information in the fields of inflammatory and inflammatory-related diseases, disorders and conditions, pharmaceuticals, biomedicine, clinical trials and post-market trials; providing information relating to the diagnostic, prophylactic and therapeutic properties of pharmaceutical preparations and biologic preparations for the prevention and treatment of diseases, disorders and conditions.

Claims

Priority Filing Date: July 30, 2018, Country or Office: SWITZERLAND, Application No: 76613/2018 in association with the same kind of goods and in association with the same kind of services

Application Number 1,941,591
Language of Application English

Filing Date 2019-01-18

APPLICANT AND AGENT DETAILS

Applicant

TUBETAMER, LLC
14246 Augusta Drive,
Valley Center,
California 92082
UNITED STATES OF AMERICA

Agent

MCCARTHY TETRAULT LLP
SUITE 5300, TORONTO DOMINION BANK
TOWER, TORONTO-DOMINION CENTRE, 66
Wellington Street West, Suite 5300, Box 48,
TORONTO, ONTARIO, M5K1E6

TRADEMARK DETAILS

TUBETAMER

Trademark Type

Word

Goods

Class 10

Medical device for securing endotracheal tube.

Claims

Priority Filing Date: July 23, 2018, Country or Office: UNITED STATES OF AMERICA, Application No: 88/049,228 in association with the same kind of goods

Application Number 1,941,595
Language of Application English

Filing Date 2019-01-18

APPLICANT AND AGENT DETAILS

Applicant
CHAMPAGNE JACQUART
34, boulevard Lundy
51100 REIMS
FRANCE

Agent
ROBIC
630, boul. René-Lévesque Ouest, 20e étage,
Montréal, QUEBEC, H3B1S6

TRADEMARK DETAILS

Trademark Type
Design

Visual Representation



Goods

Class 33

Alcoholic beverages (except beers), namely, wines, sparkling wines, champagne.

Claims

Priority Filing Date: October 30, 2018, Country or Office: FRANCE, Application No: 184495725 in association with the same kind of goods

Application Number 1,941,596
Language of Application English

Filing Date 2019-01-18

APPLICANT AND AGENT DETAILS

Applicant
CHAMPAGNE JACQUART
34, boulevard Lundy
51100 REIMS
FRANCE

Agent
ROBIC
630, boul. René-Lévesque Ouest, 20e étage,
Montréal, QUEBEC, H3B1S6

TRADEMARK DETAILS

Trademark Type
Design

Visual Representation



Goods

Class 33

Alcoholic beverages (except beers), namely, wines, sparkling wines, champagne.

Claims

Priority Filing Date: October 30, 2018, Country or Office: FRANCE, Application No: 184495731 in association with the same kind of goods

Application Number 1,941,647
Language of Application English

Filing Date 2019-01-18

APPLICANT AND AGENT DETAILS

Applicant

Foghorn Therapeutics Inc.
500 Technology Square
Suite 700
Cambridge, MA 02139
UNITED STATES OF AMERICA

Agent

SMART & BIGGAR LLP
2300 - 1055 West Georgia Street, P.O. Box
11115, Vancouver, BRITISH COLUMBIA,
V6E3P3

TRADEMARK DETAILS

FOGHORN

Trademark Type

Word

Goods

Class 01

(1) Agents for scientific and research use, namely, pharmaceutical agents that modulate epigenetic mechanisms to treat disease for use in the field of biotechnology; chemical agents for use in the research, testing, and development of pharmaceuticals and research on epigenetic structures and functions; cell culture reagents for scientific and medical research use.

Class 05

(2) Agents for medical and veterinary use, namely, pharmaceutical preparations for the treatment of diseases and disorders, namely, oncological, neurological, hematological, bone, respiratory, central nervous system, endocrinological, metabolic, circulatory, gastroenterological, hormonal and diabetic disorders; pharmaceuticals, namely, epigenetic modulating agents and chromatin regulating agents to treat disease; clinical diagnostic reagents, preparations and substances for medical purposes; diagnostic chemical reagents for medical purposes

Application Number 1,941,673
Language of Application English

Filing Date 2019-01-18

APPLICANT AND AGENT DETAILS

Applicant

Molinos Valle del Cibao, S.A.
Km 5 1/2, Carretera Santiago Licey
Santiago de los Caballeros
DOMINICAN REPUBLIC

Agent

DJB
500 Boulevard Gouin E, Suite 302, Montréal,
QUEBEC, H3L3R9

TRADEMARK DETAILS

Trademark Type

Design

Visual Representation

The word "Princesa" is written in a large, red, serif font. The letters are bold and have a classic, slightly ornate appearance. The 'P' is particularly large and prominent.

Colour Claim

Colour is claimed as a feature of the trade-mark. The word PRINCESA is in red.

Foreign Character Translation

The translation provided by the applicant of the Spanish word(s) Princesa is Princess.

Goods

Class 30

Crackers, cookies, biscuits, cakes; pasta, flour.

Application Number 1,941,774
Language of Application English

Filing Date 2019-01-21

APPLICANT AND AGENT DETAILS

Applicant

Colgate-Palmolive Canada Inc.
Two Morneau Sobeco Center, 6th Floor
895 Don Mills Road
Toronto
ONTARIO
M3C1W3

Agent

SMART & BIGGAR LLP
1100-150 York street, TORONTO, ONTARIO,
M5H3S5

TRADEMARK DETAILS

Trademark Type

Design

Visual Representation



Colour Claim

Colour is claimed as a feature of the trademark. The colours red, white, blue, green, orange, purple, pink and gold and light pink are claimed as a feature of the mark. The word 'Total' is gold with blue shadowing. Starting clockwise, the vertical coloured bars above the letter 'T' are pink, red, orange, orange. The vertical coloured bars below the letter 'l' are pink, purple, purple, purple, blue, green, green, blue. The areas that appear as white are white.

Goods

Class 03

Non-medicated mouthwash

Application Number 1,941,846
Language of Application English

Filing Date 2019-01-21

APPLICANT AND AGENT DETAILS

Applicant

DUCO TOURING LIMITED
Outside Accounting Limited
Level 2, 182 Vivian Street
Te Aro, Wellington 6142
NEW ZEALAND

Agent

LISA D. STATT FOY
(Field LLP), 400 - 444 7 Avenue SW,
CALGARY, ALBERTA, T2P0X8

TRADEMARK DETAILS

SYNTHONY

Trademark Type

Standard Characters

Services

Class 41

Event management services in relation to the organisation of educational, entertainment, sporting or cultural events namely arranging and conducting musical concerts and festivals, including ticket reservation and booking of seats for musical concerts and festivals; Management of cultural events namely arranging and conducting musical concerts and festivals ; Management of entertainment events namely arranging and conducting musical concerts and festivals; Organisation of entertainment events namely arranging and conducting musical concerts and festivals ; Organisation of musical events namely arranging and conducting musical concerts and festivals; Organisation of promotions (entertainment events) namely arranging and conducting musical concerts and festivals; Organising events for cultural purposes namely arranging and conducting musical concerts and festivals; Organising events for entertainment purposes namely arranging and conducting musical concerts and festivals; Organising of entertainment and social events namely, orchestra performances, choral performances, disk jockey performances, and live music concerts; Provision of recreational events namely, orchestra performances, choral performances, disk jockey performances, and live music concerts

Claims

Priority Filing Date: September 04, 2018, Country or Office: AUSTRALIA, Application No: 1951711 in association with the same kind of services

Application Number 1,941,999
Language of Application English

Filing Date 2019-01-22

APPLICANT AND AGENT DETAILS

Applicant

Frontier Agri-Science Inc.
98 Ontario Street
Port Hope
ONTARIO
L1A2V2

Agent

GOWLING WLG (CANADA) LLP
SUITE 2600, 160 ELGIN STREET, OTTAWA,
ONTARIO, K1P1C3

TRADEMARK DETAILS

CAHD

Trademark Type

Word

Services

Class 42

(1) Design and development of herbicides using computer aided design software; Agricultural research; Agrochemical research; Chemical research; Research and development in the field of chemistry for increasing crop yields

Class 44

(2) Advisory and consultancy services in relation to the use of herbicides

Application Number 1,942,049
Language of Application English

Filing Date 2019-01-22

APPLICANT AND AGENT DETAILS

Applicant

LIMITED LIABILITY COMPANY
"INTERCERAMA"
vul. Baikalska, 2 , smt Slobozhanske,
Dniprovskiyi r-n
Dnipropetrovska obl, 52005
UKRAINE

Agent

MBM INTELLECTUAL PROPERTY LAW LLP
275 SLATER STREET, 14TH FLOOR,
OTTAWA, ONTARIO, K1P5H9

TRADEMARK DETAILS

Trademark Type

Design

Visual Representation



**INTER
GRES**

Goods

Class 19

Ceramic tiles, not of metal, for building; wall ceramic tiles, not of metal; floor ceramic tiles, not of metal; glazed ceramic wall tiles, not of metal; glazed ceramic floor tiles, not of metal

Application Number 1,942,194
Language of Application English

Filing Date 2019-01-23

APPLICANT AND AGENT DETAILS

Applicant

Siemens Medical Solutions USA, Inc.
40 Liberty Blvd.
Malvern, PA 19355
UNITED STATES OF AMERICA

Agent

SMART & BIGGAR LLP
SUITE 900, 55 METCALFE STREET, P.O.
BOX 2999, STATION D, OTTAWA, ONTARIO,
K1P5Y6

TRADEMARK DETAILS

FlowMotion

Trademark Type

Standard Characters

Goods

Class 09

(1) Data processing programs, in particular computer software for medical imaging system and medical information systems, computer software for reproducing, transmitting and processing medical data, images and scan orders, all aforesaid for use with PET CT (positron emission tomography - computed tomography) scanners and PET MR (positron emission tomography - magnetic resonance) scanners

Class 10

(2) Medical imaging apparatus, namely, medical apparatus for the display of tomographic data, apparatus for magnetic resonance imaging, namely PET CT (positron emission tomography - computed tomography) scanners and PET MR (positron emission tomography - magnetic resonance) scanners

Application Number 1,942,255
Language of Application English

Filing Date 2019-01-23

APPLICANT AND AGENT DETAILS

Applicant

Brother Industries, Ltd.
15-1 Naeshiro-cho, Mizuho-ku
Nagoya-shi, 467-8561
JAPAN

Agent

BERESKIN & PARR LLP/S.E.N.C.R.L., S.R.L.
SCOTIA PLAZA, 40 KING STREET WEST,
40th FLOOR, TORONTO, ONTARIO, M5H3Y2

TRADEMARK DETAILS

STELLAIRE

Trademark Type

Word

Goods

Class 07

Sewing machines and sewing machine parts; embroidery machines and embroidery machine parts; sewing machines with automatic embroidery functions and sewing machine with automatic embroidery function parts

Application Number 1,942,329
Language of Application English

Filing Date 2019-01-23

APPLICANT AND AGENT DETAILS

Applicant

CORPORATE RENAISSANCE GROUP INC.
6 Antares Dr. Phase 1, Suite 200
Ottawa
ONTARIO
K2E8A9

Agent

MARY GRIFFITH
2 Bloor Street East, Suite 3500, Toronto,
ONTARIO, M4W1A8

TRADEMARK DETAILS

CRG Company Combiner

Trademark Type

Word

Goods

Class 09

Software computer program specifically for changing and combining the codes and databases used to identify customers, vendors and accounts in financial accounting systems.

Services

Class 42

Computer services, computer programming services, and technical support, namely for changing and combining the codes and databases used to identify customers, vendors and accounts in financial accounting systems

Application Number 1,942,330
Language of Application English

Filing Date 2019-01-23

APPLICANT AND AGENT DETAILS

Applicant

CORPORATE RENAISSANCE GROUP INC.
6 Antares Dr. Phase 1, Suite 200
Ottawa
ONTARIO
K2E8A9

Agent

MARY GRIFFITH
2 Bloor Street East, Suite 3500, Toronto,
ONTARIO, M4W1A8

TRADEMARK DETAILS

CRG Changer

Trademark Type

Word

Goods

Class 09

Software specifically pre-recorded computer programs specifically for changing and combining the codes used to identify customers, vendors and accounts in financial accounting systems

Application Number 1,942,408
Language of Application English

Filing Date 2019-01-24

APPLICANT AND AGENT DETAILS

Applicant
MYMARFARM ENTERPRISE CO., LTD.
NO.78, QIDONG ST., ZHONGZHENG DIST.
TAIPEI CITY
TAIWAN

Agent
DJB
500 Boulevard Gouin E, Suite 302, Montréal,
QUEBEC, H3L3R9

TRADEMARK DETAILS

Trademark Type
Design

Visual Representation



Goods

Class 11

(1) Electric coffee brewers.

Class 16

(2) Paper bags; boxes of paper; paper bags for packaging; boxes of paper or cardboard; paper shopping bags; paper containers; coasters of paper; stickers; stickers and transfers; plastic stickers; napkin paper; envelopes; menu, namely, paper menus; promotional leaflets; books; handbooks; hang tags of paper; labels of paper, brand labels of paper.

Class 21

(3) Paper cups; mugs; coffee cups; glass, namely, drinking glasses; tea caddies; coffee cup tray; heat insulated containers for beverages; coffee services (tableware); ceramic containers, namely, ceramic containers for household purposes; tile containers, namely, all-purpose portable household containers; cups; insulated vacuum flasks; coffee jars; food storage containers of glass; food preserving jars of glass; food storage containers of ceramic; food preserving jars of ceramic.

Class 30

(4) Coffee; instant coffee dripper bags, namely, powdered coffee in drip bags; coffee beans; artificial coffee; instant coffee; tea, tea leaves; tea bags; tea-based beverages; iced tea; coffee-based beverages; instant noodles pack; vegetal preparations for use as coffee substitutes; chicory for use as coffee substitutes; chocolate; cocoa-based beverages; chocolate beverages with milk; coffee beverages with milk.

Application Number 1,943,097
Language of Application English

Filing Date 2019-01-28

APPLICANT DETAILS

Applicant

Chang Ge
73 Blythwood Rd
Waterloo
ONTARIO
N2L4A1

TRADEMARK DETAILS

MEMAIL

Trademark Type

Word

Services

Class 38

electronic mail and mailbox services; email and mailbox services; email forwarding services; email services; provision of email services; secure email services

Application Number 1,943,120
Language of Application English

Filing Date 2019-01-28

APPLICANT AND AGENT DETAILS

Applicant

Shenzhen Bailihua Technology Co., Ltd.
Zone D, 2nd Floor, Warehouse of Baisha
Logistics Company, 3011 Shahexi Road
Shuguang Community, Xili Street, Nanshan
District, Shenzhen
CHINA

Agent

MARK W. TIMMIS
(MARK TIMMIS LAW CORPORATION), 2595
CAVENDISH AVENUE, VICTORIA, BRITISH
COLUMBIA, V8R2G5

TRADEMARK DETAILS

Trademark Type

Design

Visual Representation



Goods

Class 09

headsets; battery chargers for cell phones; global positioning system transmitters; global positioning system (GPS) receivers; downloadable applications for mobile phones to enable the streaming of music; smartwatches; smart rings; humanoid robots with artificial intelligence; computer keyboards; virtual reality headsets; mobile telephones; cell phones; cellular phones

Application Number 1,943,145
Language of Application English

Filing Date 2019-01-29

APPLICANT AND AGENT DETAILS

Applicant

ZILONG GAME LIMITED
FLAT/RM 06, 3/F, BONHAM TRADE CENTRE
50 BONHAM STRAND
SHEUNG WAN
HONG KONG

Agent

AVENTUM IP LAW LLP
Suite 104, Tower A, 555 Legget Drive, Ottawa,
ONTARIO, K2K2X3

TRADEMARK DETAILS

Trademark Type

Design

Visual Representation



Goods

Class 09

Computer keyboards; computer games; downloadable computer games; computer programs for using the Internet and the World Wide Web; computer programs and software for image processing; computer programs for processing digital music files; computer programs for connecting to remote computers and computer networks; computer software for creating video games; computer software for creating computer games; computer software for creating and editing music and sounds; computer hardware and computer software for database management; joysticks for use with computers, other than for video games; memory cards for video game machines; downloadable electronic publications in the nature of magazines; blank smart cards; identification smart cards; blank integrated circuit cards; video game cartridges; sound transmitting apparatus, namely, sound amplifiers, loudspeakers, radios, stereo headsets, headphones, earpieces and microphones; cabinets for loudspeakers.

Application Number 1,943,182
Language of Application English

Filing Date 2019-01-29

APPLICANT AND AGENT DETAILS

Applicant

Eclairage Axis Inc.
2505 Senkus
LaSalle
QUEBEC
H8M2X8

Agent

R.GRANT CANSFIELD
(c/o AIRD & BERLIS LLP), BROOKFIELD
PLACE, SUITE 1800, 181 BAY STREET,
TORONTO, ONTARIO, M5J2T9

TRADEMARK DETAILS

POSE

Trademark Type

Word

Goods

Class 11

Indoor and outdoor LED light fixtures

Application Number 1,943,193
Language of Application English

Filing Date 2019-01-29

APPLICANT AND AGENT DETAILS

Applicant

Scott Yoonho Kim
A-1205, 8, Yeoui-daero
Yeongdeungpo-gu
Seoul 07320
REPUBLIC OF KOREA

Agent

CASSAN MACLEAN IP AGENCY INC.
190 O'CONNOR STREET, SUITE 710,
OTTAWA, ONTARIO, K2P2R3

TRADEMARK DETAILS

Trademark Type

Design

Visual Representation



Goods

Class 09

(1) Downloadable electronic magazines; Downloadable electronic books; Downloadable electronic newspapers; Downloadable digital music; Downloadable electronic educational books; Pre-recorded nonmusical audio video tapes containing movies and television shows; Prerecorded video tapes, video cassettes and video discs featuring animated cartoons; Slide film; Phonograph records; Pre-recorded music compact discs containing music; Pre-recorded audio tapes containing music; Pre-recorded CDs, DVDs, optical discs, video discs and USB flash drives containing music; Pre-recorded CDs, DVDs, optical discs, video discs and USB flash drives containing movies, television shows.

Class 25

(2) Casual footwear, exercise footwear, outdoor winter footwear, sports footwear; Shoes; Climbing boots; Boots; Sandals; Sports shoes; Slippers; Overshoes; Training shoes; Long boots; Climbing shirts, climbing shorts, climbing pants; Jogging Suits; Swimsuits; Ski suits; Sports wear; Sports jackets; Short trousers; Blue jeans; Muffler scarves; Winter ear muffs; Winter gloves; Socks; Hats; Belts made of leather; Athletic clothing, business clothing, casual clothing.

Services

Class 41

Entertainment services in the form of live performances by a musical band; Theatre management, theatre production; Arranging and conducting pop music concerts; Production of radio and television programmes; Presentation of live performances in the form of musical concerts, comedy shows, musical variety shows, theatrical performances and dance performances; Production of live

performances in the form of musical concerts, comedy shows, musical variety shows, theatrical performances and dance performances; Providing entertainment information in the field of television shows and movies, concert listings and concert tickets; Audio and video recording services; Distribution (other than transportation) of music recordings; Production of music records; Live music performances by a musical band; Production of live music concerts; Music composition services; Operation of a music hall; Arranging and conducting of musical concerts; Presentation of musical concerts; Event planning services; Recording studio services; Nightclub entertainment services.

Application Number 1,943,530
Language of Application English

Filing Date 2019-01-30

APPLICANT AND AGENT DETAILS

Applicant

Jeaniologie Inc.
4951 Boul De La Côte-Vertu
Montreal
QUEBEC
H4S1E1

Agent

SMART & BIGGAR LLP
1000 RUE DE LA GAUCHETIERE OUEST,
BUREAU 3300, MONTREAL, QUEBEC,
H3B4W5

TRADEMARK DETAILS

Trademark Type

Design

Visual Representation

Jeaniologie

Goods

Class 09

(1) Sunglasses

Class 14

(2) Watches

Class 18

(3) Bags, namely handbags and tote bags (but specifically excluding sports bags, gym bags or bags used to carry sporting equipments such as surfboards and snowboards); wallets

Class 25

(4) Wearing apparel, namely jeans, pants, shirts, t-shirts, dresses, skirts, blouses and jackets, shoes, belts, suspenders; socks, hosiery, lingerie, underwear, swimsuits; sleepwear, namely pyjamas; hats

Application Number 1,943,545
Language of Application English

Filing Date 2019-01-30

APPLICANT AND AGENT DETAILS

Applicant

CSN Collision Centres Inc.
102-377 Evans Ave
Toronto
ONTARIO
M8Z1K8

Agent

DAVID J. GRAY
Suite 1104, 4789 Yonge Street, Toronto,
ONTARIO, M2N0G3

TRADEMARK DETAILS

Trademark Type

Design

Visual Representation



///CSN
COLLISION CENTRES

Services

Class 35

(1) auto body repair services, namely the operation of a call centre

Class 36

(2) auto body repair services, namely insurance claims management and motor vehicle appraisal services

Class 37

(3) auto body repair services, namely automotive refinishing

Class 39

(4) auto body repair services, namely vehicle towing services and car rental services

Application Number 1,943,546
Language of Application English

Filing Date 2019-01-30

APPLICANT AND AGENT DETAILS

Applicant

CSN Collision Centres Inc.
102-377 Evans Ave
Toronto
ONTARIO
M8Z1K8

Agent

DAVID J. GRAY
Suite 1104, 4789 Yonge Street, Toronto,
ONTARIO, M2N0G3

TRADEMARK DETAILS

CSN COLLISION CENTRES

Trademark Type

Standard Characters

Services

Class 35

(1) auto body repair services, namely the operation of a call centre

Class 36

(2) auto body repair services, namely insurance claims management and motor vehicle appraisal services

Class 37

(3) auto body repair services, namely automotive refinishing

Class 39

(4) auto body repair services, namely vehicle towing services and car rental services

Application Number 1,943,547
Language of Application English

Filing Date 2019-01-30

APPLICANT AND AGENT DETAILS

Applicant

CSN Collision Centres Inc.
102-377 Evans Ave
Toronto
ONTARIO
M8Z1K8

Agent

DAVID J. GRAY
Suite 1104, 4789 Yonge Street, Toronto,
ONTARIO, M2N0G3

TRADEMARK DETAILS

NO MATTER WHAT HAPPENS ... WE'LL STRAIGHTEN IT OUT

Trademark Type

Standard Characters

Services

Class 35

(1) auto body repair services, namely the operation of a call centre

Class 36

(2) auto body repair services, namely insurance claims management and motor vehicle appraisal services

Class 37

(3) auto body repair services, namely automotive refinishing

Class 39

(4) auto body repair services, namely vehicle towing services and car rental services

Application Number 1,943,587
Language of Application English

Filing Date 2019-01-30

APPLICANT AND AGENT DETAILS

Applicant

Staceypants, Inc., a New York Corporation
c/o Alice + Olivia, LLC
450 West 14th Street
New York, NY 10014
UNITED STATES OF AMERICA

Agent

MCMILLAN LLP
BROOKFIELD PLACE, SUITE 4400, BAY
WELLINGTON TOWER, 181 BAY STREET,
TORONTO, ONTARIO, M5J2T3

TRADEMARK DETAILS

Trademark Type

Design

Visual Representation



Trademark Description

The mark consists of a stylized woman's face in white featuring large black framed sunglasses with circular grey lenses appearing above red lips outlined in black, and black hair which is in a bun.

Colour Claim

Colour is claimed as a feature of the trade-mark. The mark consists of a stylized woman's face in white featuring large black framed sunglasses with circular grey lenses appearing above red lips outlined in black, and black hair which is in a bun.

Goods

Class 14

(1) Jewelry; key chains

Class 18

(2) Handbags; purses; clutches; wallets; cosmetic cases sold empty; tote bags; pouches for holding make-up, keys and other personal items; credit card cases and holders; luggage

Class 25

(3) footwear, namely, shoes, slippers, boots, sandals and sneakers; sweaters, sweatshirts; shirts; t-shirts; blouses; knit tops; camisoles; tank tops; blazers; coats; jackets; vests; dresses; skirts; pants; leggings; sweatpants; jeans; shorts; hats; caps; mittens; gloves; scarves; socks; hosiery; lingerie; sports bras; bathing suits; belts

Application Number 1,943,737
Language of Application French

Filing Date 2019-01-31

APPLICANT AND AGENT DETAILS

Applicant

VERALLIA PACKAGING, Société par actions
simplifiée à associé unique
Tour CARPE DIEM
Place des Corolles - Esplanade Nord
92400 Courbevoie
FRANCE

Agent

NORTON ROSE FULBRIGHT CANADA LLP/S.
E.N.C.R.L., S.R.L.
COMPLEXE JULES-DALLAIRE/TOUR
OGILVY RENAULT , BUREAU 1500, 2828,
BOULEVARD LAURIER, QUÉBEC, QUÉBEC,
G1V0B9

TRADEMARK DETAILS

Trademark Type

Design

Visual Representation



Goods

Class 21

Unworked glass (except building glass); semi-worked glass (except building glass); glass packaging used in the food and beverage industries, namely bottles, table glassware, pots, jars; insulated flasks; beverage flasks; food and beverage containers for household use; pouring spouts; glass stoppers; glass balls; glass boxes; vases; enamelled glass; painted glass; hermetically sealed glass containers for preserving foodstuffs; perfume atomizers; perfume vaporizers; incense burners; decanters; siphon bottles for carbonated water; glass mosaics not for construction; opal glass; glass containers for drinking, namely drinking glasses, wine glasses, tumblers; household or kitchen containers, namely dishes, cups, coasters, plates, bowls, salad bowls, mixing bowls, vases, decanters, jars, boxes made of glass, and pots; refrigerating bottles; powdered glass for decoration. .

Claims

Priority Filing Date: August 01, 2018, Country or Office: FRANCE, Application No: 18 4 473 569 in association with the same kind of goods

Application Number 1,943,738
Language of Application English

Filing Date 2019-01-31

APPLICANT AND AGENT DETAILS

Applicant

Home Improvement Systems, Inc.
2530 Spring Grove Avenue
Cincinnati, OH 45214
UNITED STATES OF AMERICA

Agent

COLLEEN SPRING ZIMMERMAN
(FOGLER, RUBINOFF LLP), 77 KING
STREET WEST, SUITE 3000, P.O. Box 95,
TORONTO-DOMINION CENTRE, TORONTO,
ONTARIO, M5K1G8

TRADEMARK DETAILS

SCREENEZE

Trademark Type

Word

Goods

Class 06

metal window screens

Application Number 1,943,959
Language of Application English

Filing Date 2019-02-01

APPLICANT AND AGENT DETAILS

Applicant

Bumble and Bumble, LLC
415 West 13th Street
New York, NY 10014
UNITED STATES OF AMERICA

Agent

BERESKIN & PARR LLP/S.E.N.C.R.L., S.R.L.
SCOTIA PLAZA, 40 KING STREET WEST,
40th FLOOR, TORONTO, ONTARIO, M5H3Y2

TRADEMARK DETAILS

PRET-A-POWDER TRES INVISIBLE

Trademark Type

Word

Goods

Class 03

hair care preparations

Application Number 1,944,020
Language of Application English

Filing Date 2019-02-01

APPLICANT AND AGENT DETAILS

Applicant

The Procter & Gamble Company
One Procter & Gamble Plaza
Cincinnati , OH 45202
UNITED STATES OF AMERICA

Agent

TORYS LLP
SUITE 3000, 79 WELLINGTON ST. W., BOX
270, TD CENTRE, TORONTO, ONTARIO,
M5K1N2

TRADEMARK DETAILS

GENOPTICS ULTRAURA ESSENCES

Trademark Type

Word

Goods

Class 03

skin care preparations

Application Number 1,944,137
Language of Application English

Filing Date 2019-02-01

APPLICANT AND AGENT DETAILS

Applicant

PASTIFICIO RANA S.p.A.
Via Pacinotti 25
SAN GIOVANNI LUPATOTO - VERONA
ITALY

Agent

MBM INTELLECTUAL PROPERTY LAW LLP
275 SLATER STREET, 14TH FLOOR,
OTTAWA, ONTARIO, K1P5H9

TRADEMARK DETAILS

LIVE LIFE GENEROUSLY

Trademark Type

Word

Goods

Class 29

(1) Tomato preserves; Tomato paste; Tomato juice for cooking; Tomato purée; Preparations for making soup; Milk products; Vegetable juices for cooking; Vegetable soup preparations; Cheese; dairy cream, sour cream, whipped cream [dairy products]; cooked vegetables, namely, canned tomatoes, jalapeno peppers, carrots, vegetable side dishes; preserved vegetables; Broth; Pre-cooked soup; frozen fish; frozen meat; Frozen meals consisting primarily of meat and fish; Quick-frozen vegetable dishes; Mixes for making soup; Cheese dips; Potato-based dumplings; Potato-based gnocchi; Prepared meals consisting principally of vegetables; Prepared dishes consisting principally of meat and fish; canned fruit, frozen fruit, fruit purée

Class 30

(2) Pasta; pasta containing stuffings; fresh pasta; puff pastry; dried pasta; wholemeal pasta; deep frozen pasta; bread doughs; pizza dough; cake batter; pasta-based prepared meals; rice-based prepared meals; pasta sauce; vegetable-based seasonings for pasta; macaroni with cheese; frozen meals consisting primarily of pasta; fish dumplings; flour-based gnocchi; gnocchi; dumplings; tortellini; ravioli; meat gravies; preparations for making sauces, namely, sauce mixes; preparations for bakery products, namely, flour, sugar, fruit flavourings, fruit sauces; sauces for rice, namely soya sauce; ready-made sauces, namely, tartar sauce, worcestershire sauce, spaghetti sauce, pizza sauce, gnocchi sauce, bolognese sauce, meat sauce; sauces [condiments], namely, ketchup, mayonnaise, mustard, hot sauce, sweet chilli sauce, pasta sauce, pesto sauces; dressings for salad; tomato sauce; lasagna; frozen dough; frozen pastries; frozen pastry stuffed with meat and vegetables; boxed lunches consisting of rice, with added meat, fish or vegetables; pastries consisting of vegetables and fish; pies containing fish; quiches; tarts; pizza; fresh pizza; pizza bases; pizza crust; semolina; processed semolina; aromatic preparations for food, namely, food flavourings, dried herbs for food purposes, spices, vinegar; condiments, namely, ketchup, mustard, relish, mayonnaise; pancakes; macaroni; yeast extract; macaroni salad; noodles; spaghetti; vermicelli [noodles]; meat pies; rice; bread; dough; rice pulp for culinary purposes

Claims

Priority Filing Date: January 23, 2019, Country or Office: ITALY, Application No:
302019000005743 in association with the same kind of goods

Application Number 1,944,217
Language of Application English

Filing Date 2019-02-04

APPLICANT DETAILS

Applicant

Jason Keller and Kim Feragen Partnership
6115 Acadia PI
Prince George
BRITISH COLUMBIA
V2N2N4

TRADEMARK DETAILS

Nutz On Your Gin

Trademark Type

Word

Goods

Class 33

Fruit and nut-infused gin

Application Number 1,944,269
Language of Application English

Filing Date 2019-02-04

APPLICANT AND AGENT DETAILS

Applicant

The Procter & Gamble Company
One Procter & Gamble Plaza
Cincinnati, OH 45202
UNITED STATES OF AMERICA

Agent

TORYS LLP
SUITE 3000, 79 WELLINGTON ST. W., BOX
270, TD CENTRE, TORONTO, ONTARIO,
M5K1N2

TRADEMARK DETAILS

Never Stray

Trademark Type

Word

Goods

Class 03

hair care preparations, hair styling preparations

Claims

Priority Filing Date: January 29, 2019, Country or Office: SWITZERLAND, Application No: 012572019 in association with the same kind of goods

Application Number 1,944,418
Language of Application English

Filing Date 2019-02-04

APPLICANT AND AGENT DETAILS

Applicant

Rogers Corporation
2225 W. Chandler Blvd.
Chandler, AZ 85224
UNITED STATES OF AMERICA

Agent

NORTON ROSE FULBRIGHT CANADA LLP/S.
E.N.C.R.L.,S.R.L.
COMPLEXE JULES-DALLAIRE/TOUR
OGILVY RENAULT , BUREAU 1500, 2828,
BOULEVARD LAURIER, QUÉBEC, QUEBEC,
G1V0B9

TRADEMARK DETAILS

PORON EVExtend

Trademark Type

Word

Goods

Class 17

Microporous plastic sheet used in the manufacture of Lithium-Ion battery pouch cells

Claims

Priority Filing Date: November 16, 2018, Country or Office: UNITED STATES OF AMERICA,
Application No: 88/197,273 in association with the same kind of goods

Application Number 1,944,434
Language of Application English

Filing Date 2019-02-04

APPLICANT AND AGENT DETAILS

Applicant

Horizon Blockchain Games Inc.
147 Liberty Street
Toronto
ONTARIO
M6K3G3

Agent

BLAKE, CASSELS & GRAYDON LLP
INTELLECTUAL PROPERTY GROUP, SUITE
4000, COMMERCE COURT WEST, 199 BAY
STREET, TORONTO, ONTARIO, M5L1A9

TRADEMARK DETAILS

HORIZON BLOCKCHAIN GAMES

Trademark Type

Word

Goods

Class 09

Computer software for creating blockchain-based video games; Computer video games that use blockchain technology for decentralized gaming and for players to earn rewards through gameplay via in-game cryptocurrencies.

Services

Class 35

(1) Marketing services for others in the field of blockchain video games, open source games and multi-user games using open economies with earned rewards through game play via in-game crypto-currencies.

Class 42

(2) Software services, namely, providing a video game platform that allow users access to blockchain-based video games and computer software for creating blockchain video games.

Application Number 1,944,451
Language of Application English

Filing Date 2019-02-04

APPLICANT AND AGENT DETAILS

Applicant

Nodi Handmade Rugs Limited
Olivia Smith Shop 3
1 Faraday Street, Parnell
Auckland 1052
NEW ZEALAND

Agent

NORTON ROSE FULBRIGHT CANADA LLP/S.
E.N.C.R.L.,S.R.L.
1800 - 510 West Georgia Street, Vancouver,
BRITISH COLUMBIA, V6B0M3

TRADEMARK DETAILS

Trademark Type

Design

Visual Representation



nodi

Goods

Class 27

Floor rugs; rugs; carpets, rugs, floor mats and floor matting, linoleum for covering existing floors

Claims

Priority Filing Date: December 04, 2018, Country or Office: NEW ZEALAND, Application No: 1108847 in association with the same kind of goods

Application Number 1,944,487
Language of Application French

Filing Date 2019-02-05

APPLICANT AND AGENT DETAILS

Applicant

MACDONALD & MUIR LIMITED
THE CUBE, 45 LEITH STREET
EDINBURGH ÉCOSSE EH1 3AT
ROYAUME-UNI

Agent

ROBIC
630, boul. René-Lévesque Ouest, 20e étage,
Montréal, QUÉBEC, H3B1S6

TRADEMARK DETAILS

MASTERS OF SMOKE

Trademark Type

Word

Goods

Class 16

(1) Imprimés, notamment calendriers, communiqués imprimés, bulletins d'information imprimés, étiquettes imprimées en papier, étiquettes imprimées, invitations imprimées, listes de prix imprimées, livrets imprimés, manuels imprimés, magazines, livres, rapports imprimés sur le consommateur, feuillets publicitaires imprimés; imprimés promotionnels, notamment bons de réduction imprimés, bons d'échange imprimés, chèque-cadeau, à savoir cartes-cadeaux imprimées, panneaux publicitaires imprimés en papier, panneaux publicitaires imprimés en carton; affiches; brochures; articles de papeterie, notamment papeterie, articles de papeterie pour l'écriture, organisateurs personnels de bureau; sous-verres à bière; sous-verres en papier; serviettes de table en papier; instruments d'écriture; panneaux, en papier ou en carton.

Class 33

(2) Whisky.

Services

Class 35

Services de conseil aux entreprises ayant trait au franchisage; services de publicité, de promotion et de marketing, notamment offre d'information sur la publicité des produits et des services de tiers, conseils en affaires ayant trait à la publicité, production de matériel publicitaire pour des tiers, publicité des produits et des services de tiers, consultation en publicité, services de planification de publicité, offre d'information sur des études de marché, offre d'information de marketing d'entreprise pour des tiers, administration de programmes incitatifs de promotion des ventes, promotion de produits par des influenceurs pour des tiers promotion des produits et des services de tiers par un programme de cartes de fidélité, administration d'un programme de réduction permettant aux participants d'obtenir des réductions sur des produits et des services en utilisant une carte de réduction pour les membres, promotion de produits et de services par la distribution de cartes de réduction, conception de sondages de marketing, consultation en évaluation de marché, consultation en stratégie de médias sociaux; préparation et publication de textes et de matériel publicitaires, notamment publication de textes publicitaires, publication et mise à jour de textes publicitaires pour des tiers, rédaction de textes publicitaires pour des tiers; conseils et aide

en gestion des affaires; planification des affaires; services d'organisation, notamment aide commerciale à la gestion des affaires, aide à l'administration des affaires, consultation en gestion et en organisation des affaires; organisation et tenue de causeries et de dégustations à des fins promotionnelles et publicitaires, notamment préparation, organisation et tenue de dégustations de whisky et d'évènements de dégustation de whisky à des fins promotionnelles; organisation de compétitions à des fins commerciales et d'affaires, notamment organisation et tenue de salons commerciaux ainsi que de salons professionnels dans le domaine du whisky, promotion de la vente de produits et de services par des concours promotionnels et par la distribution d'imprimés connexes; distribution et diffusion de matériel et d'information publicitaires, notamment distribution et diffusion de matériel publicitaire pour des tiers, d'information sur le service à la clientèle ainsi que la gestion et les prix des produits sur des sites Internet relativement à des achats effectués sur Internet, offre d'information sur la production de matériel publicitaire et de messages publicitaires pour des tiers, placement de publicités pour des tiers.

Claims

Priority Filing Date: August 10, 2018, Country or Office: UNITED KINGDOM, Application No: UK00003330814 in association with the same kind of goods and in association with the same kind of services

Application Number 1,944,590
Language of Application English

Filing Date 2019-02-05

APPLICANT AND AGENT DETAILS

Applicant

UMA ENTERPRISES INC.
350 West Apra St.
Compton, CA 90220
UNITED STATES OF AMERICA

Agent

BERESKIN & PARR LLP/S.E.N.C.R.L., S.R.L.
SCOTIA PLAZA, 40 KING STREET WEST,
40th FLOOR, TORONTO, ONTARIO, M5H3Y2

TRADEMARK DETAILS

Trademark Type

Design

Visual Representation

Services

Class 35

On-line wholesale store services featuring home décor finished goods, namely, furniture and accent furniture, wall décor, lamps, vases, clocks, statues, decorative pillows, tabletop accessories, floral accessories, garden items and holiday décor; wholesale and retail store services featuring home décor finished goods, namely, furniture and accent furniture, wall décor, lamps, vases, clocks, statues, decorative pillows, tabletop accessories, floral accessories, garden items and holiday décor

Claims

Priority Filing Date: October 07, 2018, Country or Office: UNITED STATES OF AMERICA,
Application No: 88145834 in association with the same kind of services

Application Number 1,944,603
Language of Application English

Filing Date 2019-02-05

APPLICANT AND AGENT DETAILS

Applicant

Chicago Blackhawks Hockey Team, Inc.
1901 West Madison Street
Chicago, IL 60612
UNITED STATES OF AMERICA

Agent

BERESKIN & PARR LLP/S.E.N.C.R.L., S.R.L.
SCOTIA PLAZA, 40 KING STREET WEST,
40th FLOOR, TORONTO, ONTARIO, M5H3Y2

TRADEMARK DETAILS

Trademark Type

Design

Visual Representation



Goods

Class 06

(1) goods of non-precious metals, namely, metal license plates, door knockers, metal road signs, trophies made of common metal, weather vanes

Class 09

(2) audio and video electronics, namely, electronic notebooks, electronic tablets, personal digital assistants, smart phones, cases/covers for personal digital assistants, electronic tablets and notebooks; stands for personal digital electronic devices, namely, personal digital assistants, cell phones, and MP3 players; cell phone chargers, cell phone face plates, ear phones, blank USB flash drives, blank DVDs, computer mouse and mouse pads, pre-recorded DVDs containing computer games in the field of the game of hockey; pre-recorded videotapes, audio tape recordings, DVDs containing movies, documentaries, and films in the field of the game of hockey; downloadable electronic audio and video publications, relating to the game of hockey, namely magazines, books, multimedia news podcasts and multimedia news webcasts, video and computer games, video game cartridges and discs, binoculars, decorative switch plate covers, eyewear, namely sports eyewear, eyeglasses, sunglasses, eyeglass chains and cords, decorative magnets, tape measures, docking stations for mobile phones and MP3 players, hand-held computer, protective helmets for sports, protective visors for athletic use, neon signs

Class 11

(3) night lights, electric lamps, lampshades, refrigerators, electronic toasters

Class 12

(4) spare tire covers, license plate frames and license plate holders

Class 14

(5) Items made of precious and non-precious metals, namely, commemorative coins and medals, trophies and key chains made of precious metals, jewelry, jewelry charms, earrings, medallions, rings, necklaces, tie tacks, pins in the nature of jewelry, watches and clocks, cuff links, key chain fobs, lanyards for holding keys

Class 16

(6) Printed matter and publications, namely, address books, adhesive labels, appointment books, framed artwork, autograph books, business card holders, book covers, book marks, booklets, books, bumper stickers, calendars, check books, coloring books, commemorative game tickets, decals, diaries, envelopes, erasers, flags and pennants of paper, game and souvenir programs concerning hockey, gift tags, gift wrapping paper, greeting cards, hand painted celluloids, lithographs, magazines, note pads, paintings, pamphlets, paper banners, paper napkins, paper towels, paperweights, pencil cases, pencil sharpeners, writing instruments, photograph albums, photographs (mounted and un-mounted), postcards, posters, printed paper signs, printed awards and certificates, printed schedules, drawing rulers, scrap books, serigraphs, paper doorknob hanger signs, stickers, sticker packs and sticker albums, trading cards and trading card albums, writing pads and writing paper, money clips

Class 18

(7) soft luggage and bags, namely, all-purpose sports and sports equipment bags, back packs, duffels, knapsacks, waist packs, gym bags, garment bags for travel, satchels, tote bags, wallets, key cases, luggage tags, billfolds, umbrellas

Class 20

(8) chairs, decorative mirrors, display cases, mirrors, picture frames, pillows, novelty license plates made of plastic, stools, tables, wall plaques made of plastic or wood, billiard/pool cue racks

Class 21

(9) Bottle openers, bowls, candy jars, coffee mugs, cups and saucers, cutting boards, drink coasters, drinking cups, drinking flasks, drinking glasses, glass bowls, glass figurines, glass pitchers, barbecue grill covers, kitchen utensils namely barbecue forks, barbecue spatulas and barbecue tongs; plates, salt and pepper shakers, garbage cans, water bottles, coin banks

Class 22

(10) lanyards for holding badges

Class 24

(11) fabric and textile products, namely, beach towels, billiard cloths, blankets, cloth banners, cloth flags, pennants made of textile, bed sheets, pillow cases

Class 25

(12) clothing, namely, bandanas, beach cover-ups, belts, body suits, boxer shorts, caps, cloth bibs, coats, dresses, ear muffs, gloves, hats, headbands, hosiery, housecoats, jackets, hockey jerseys, leggings, leotards, men's dress suits and casual suits, mittens, nightshirts, pajamas, pants, rainwear, raincoats, robes, scarves, shirts, shorts, skirts, socks, sun visors, suspenders, sweaters,

sweatpants, sweatshirts, swim trunks, swimsuits, ties, toques, t-shirts, underwear, vests, warm-up suits, wristbands; Shoes, boots, sandals, slippers and athletic shoes

Class 26

(13) hair accessories, ornamental novelty buttons, patches for clothing

Class 27

(14) carpets and carpet tiles, door mats, floor and vehicle mats, rugs, yoga mats

Class 28

(15) toys, games and sporting goods, namely, action figures, adhesive tape for hockey sticks, balloons, billiard/pool cue sticks, billiard/pool balls and triangles, board games, bobble head dolls, cheerleading pom-poms, checker sets, chess sets, Christmas stockings, Christmas tree ornaments, darts and dart boards, dolls; elbow pads, shin pads, knee pads and protective gloves for athletic use; field, street, in-line and roller hockey balls; flying discs, goalie masks for hockey, golf bags, golf balls, head covers for golf clubs; hand-held home video game machine, hockey pucks, hockey sticks, ice skate blade covers, ice skate blade guards, ice skates, inline and conventional roller skates, inflatable toys, jigsaw and manipulative puzzles, kites, marbles, novelty golf balls, novelty miniature goalie masks and hockey sticks, plastic toy canteens, plush animals, puppets, stuffed figurines and animals, suction cup stuffed toy animals, scale model vehicles, table top rod hockey games, toy airplanes, toy cars, toy trucks, toy hockey games, return tops, playing cards; children's inflatable swimming pools, inflatable swimming floats for children

Class 34

(16) cigarette lighters not of precious and non-precious metal

Services**Class 41**

entertainment services, namely arranging and conducting professional hockey exhibitions

Application Number 1,944,607
Language of Application English

Filing Date 2019-02-05

APPLICANT AND AGENT DETAILS

Applicant

Chicago Blackhawks Hockey Team, Inc.
1901 West Madison Street
Chicago, IL 60612
UNITED STATES OF AMERICA

Agent

BERESKIN & PARR LLP/S.E.N.C.R.L., S.R.L.
SCOTIA PLAZA, 40 KING STREET WEST,
40th FLOOR, TORONTO, ONTARIO, M5H3Y2

TRADEMARK DETAILS

Trademark Type

Design

Visual Representation



Goods

Class 06

(1) goods of non-precious metals, namely, metal license plates, door knockers, metal road signs, trophies made of common metal, weather vanes

Class 09

(2) audio and video electronics, namely, electronic notebooks, electronic tablets, personal digital assistants, smart phones, cases/covers for personal digital assistants, electronic tablets and notebooks; stands for personal digital electronic devices, namely, personal digital assistants, cell phones, and MP3 players; cell phone chargers, cell phone face plates, ear phones, blank USB flash drives, blank DVDs, computer mouse and mouse pads, pre-recorded DVDs containing computer games in the field of the game of hockey; pre-recorded videotapes, audio tape recordings, DVDs containing movies, documentaries, and films in the field of the game of hockey; downloadable electronic audio and video publications, relating to the game of hockey, namely magazines, books, multimedia news podcasts and multimedia news webcasts, video and computer games, video game cartridges and discs, binoculars, decorative switch plate covers,

eyewear, namely sports eyewear, eyeglasses, sunglasses, eyeglass chains and cords, decorative magnets, tape measures, docking stations for mobile phones and MP3 players, hand-held computer, protective helmets for sports, protective visors for athletic use, neon signs

Class 11

(3) night lights, electric lamps, lampshades, refrigerators, electronic toasters

Class 12

(4) spare tire covers, license plate frames and license plate holders

Class 14

(5) Items made of precious and non-precious metals, namely, commemorative coins and medals, trophies and key chains made of precious metals, jewelry, jewelry charms, earrings, medallions, rings, necklaces, tie tacks, pins in the nature of jewelry, watches and clocks, cuff links, key chain fobs, lanyards for holding keys

Class 16

(6) Printed matter and publications, namely, address books, adhesive labels, appointment books, framed artwork, autograph books, business card holders, book covers, book marks, booklets, books, bumper stickers, calendars, check books, coloring books, commemorative game tickets, decals, diaries, envelopes, erasers, flags and pennants of paper, game and souvenir programs concerning hockey, gift tags, gift wrapping paper, greeting cards, hand painted celluloids, lithographs, magazines, note pads, paintings, pamphlets, paper banners, paper napkins, paper towels, paperweights, pencil cases, pencil sharpeners, writing instruments, photograph albums, photographs (mounted and un-mounted), postcards, posters, printed paper signs, printed awards and certificates, printed schedules, drawing rulers, scrap books, serigraphs, paper doorknob hanger signs, stickers, sticker packs and sticker albums, trading cards and trading card albums, writing pads and writing paper, money clips

Class 18

(7) soft luggage and bags, namely, all-purpose sports and sports equipment bags, back packs, duffels, knapsacks, waist packs, gym bags, garment bags for travel, satchels, tote bags, wallets, key cases, luggage tags, billfolds, umbrellas

Class 20

(8) chairs, decorative mirrors, display cases, mirrors, picture frames, pillows, novelty license plates made of plastic, stools, tables, wall plaques made of plastic or wood, billiard/pool cue racks

Class 21

(9) Bottle openers, bowls, candy jars, coffee mugs, cups and saucers, cutting boards, drink coasters, drinking cups, drinking flasks, drinking glasses, glass bowls, glass figurines, glass pitchers, barbecue grill covers, kitchen utensils namely barbecue forks, barbecue spatulas and barbecue tongs; plates, salt and pepper shakers, garbage cans, water bottles, coin banks

Class 22

(10) lanyards for holding badges

Class 24

(11) fabric and textile products, namely, beach towels, billiard cloths, blankets, cloth banners, cloth flags, pennants made of textile, bed sheets, pillow cases

Class 25

(12) clothing, namely, bandanas, beach cover-ups, belts, body suits, boxer shorts, caps, cloth bibs, coats, dresses, ear muffs, gloves, hats, headbands, hosiery, housecoats, jackets, hockey jerseys, leggings, leotards, men's dress suits and casual suits, mittens, nightshirts, pajamas, pants, rainwear, raincoats, robes, scarves, shirts, shorts, skirts, socks, sun visors, suspenders, sweaters, sweatpants, sweatshirts, swim trunks, swimsuits, ties, toques, t-shirts, underwear, vests, warm-up suits, wristbands; Shoes, boots, sandals, slippers and athletic shoes

Class 26

(13) hair accessories, ornamental novelty buttons, patches for clothing

Class 27

(14) carpets and carpet tiles, door mats, floor and vehicle mats, rugs, yoga mats

Class 28

(15) toys, games and sporting goods, namely, action figures, adhesive tape for hockey sticks, balloons, billiard/pool cue sticks, billiard/pool balls and triangles, board games, bobble head dolls, cheerleading pom-poms, checker sets, chess sets, Christmas stockings, Christmas tree ornaments, darts and dart boards, dolls; elbow pads, shin pads, knee pads and protective gloves for athletic use; field, street, in-line and roller hockey balls; flying discs, goalie masks for hockey, golf bags, golf balls, head covers for golf clubs; hand-held home video game machine, hockey pucks, hockey sticks, ice skate blade covers, ice skate blade guards, ice skates, inline and conventional roller skates, inflatable toys, jigsaw and manipulative puzzles, kites, marbles, novelty golf balls, novelty miniature goalie masks and hockey sticks, plastic toy canteens, plush animals, puppets, stuffed figurines and animals, suction cup stuffed toy animals, scale model vehicles, table top rod hockey games, toy airplanes, toy cars, toy trucks, toy hockey games, return tops, playing cards; children's inflatable swimming pools, inflatable swimming floats for children

Class 34

(16) cigarette lighters not of precious and non-precious metal

Services**Class 41**

entertainment services, namely arranging and conducting professional hockey exhibitions

Application Number 1,944,612
Language of Application English

Filing Date 2019-02-05

APPLICANT AND AGENT DETAILS

Applicant

Chicago Blackhawks Hockey Team, Inc.
1901 West Madison Street
Chicago, IL 60612
UNITED STATES OF AMERICA

Agent

BERESKIN & PARR LLP/S.E.N.C.R.L., S.R.L.
SCOTIA PLAZA, 40 KING STREET WEST,
40th FLOOR, TORONTO, ONTARIO, M5H3Y2

TRADEMARK DETAILS

Trademark Type

Design

Visual Representation



Goods

Class 06

(1) goods of non-precious metals, namely, metal license plates, door knockers, metal road signs, trophies made of common metal, weather vanes

Class 09

(2) audio and video electronics, namely, electronic notebooks, electronic tablets, personal digital assistants, smart phones, cases/covers for personal digital assistants, electronic tablets and notebooks; stands for personal digital electronic devices, namely, personal digital assistants, cell phones, and MP3 players; cell phone chargers, cell phone face plates, ear phones, blank USB flash drives, blank DVDs, computer mouse and mouse pads, pre-recorded DVDs containing computer games in the field of the game of hockey; pre-recorded videotapes, audio tape recordings, DVDs containing movies, documentaries, and films in the field of the game of hockey; downloadable electronic audio and video publications, relating to the game of hockey, namely magazines, books, multimedia news podcasts and multimedia news webcasts, video and computer games, video game cartridges and discs, binoculars, decorative switch plate covers, eyewear, namely sports eyewear, eyeglasses, sunglasses, eyeglass chains and cords, decorative

magnets, tape measures, docking stations for mobile phones and MP3 players, hand-held computer, protective helmets for sports, protective visors for athletic use, neon signs

Class 11

(3) night lights, electric lamps, lampshades, refrigerators, electronic toasters

Class 12

(4) spare tire covers, license plate frames and license plate holders

Class 14

(5) Items made of precious and non-precious metals, namely, commemorative coins and medals, trophies and key chains made of precious metals, jewelry, jewelry charms, earrings, medallions, rings, necklaces, tie tacks, pins in the nature of jewelry, watches and clocks, cuff links, key chain fobs, lanyards for holding keys

Class 16

(6) Printed matter and publications, namely, address books, adhesive labels, appointment books, framed artwork, autograph books, business card holders, book covers, book marks, booklets, books, bumper stickers, calendars, check books, coloring books, commemorative game tickets, decals, diaries, envelopes, erasers, flags and pennants of paper, game and souvenir programs concerning hockey, gift tags, gift wrapping paper, greeting cards, hand painted celluloids, lithographs, magazines, note pads, paintings, pamphlets, paper banners, paper napkins, paper towels, paperweights, pencil cases, pencil sharpeners, writing instruments, photograph albums, photographs (mounted and un-mounted), postcards, posters, printed paper signs, printed awards and certificates, printed schedules, drawing rulers, scrap books, serigraphs, paper doorknob hanger signs, stickers, sticker packs and sticker albums, trading cards and trading card albums, writing pads and writing paper, money clips

Class 18

(7) soft luggage and bags, namely, all-purpose sports and sports equipment bags, back packs, duffels, knapsacks, waist packs, gym bags, garment bags for travel, satchels, tote bags, wallets, key cases, luggage tags, billfolds, umbrellas

Class 20

(8) chairs, decorative mirrors, display cases, mirrors, picture frames, pillows, novelty license plates made of plastic, stools, tables, wall plaques made of plastic or wood, billiard/pool cue racks

Class 21

(9) Bottle openers, bowls, candy jars, coffee mugs, cups and saucers, cutting boards, drink coasters, drinking cups, drinking flasks, drinking glasses, glass bowls, glass figurines, glass pitchers, barbecue grill covers, kitchen utensils namely barbecue forks, barbecue spatulas and barbecue tongs; plates, salt and pepper shakers, garbage cans, water bottles, coin banks

Class 22

(10) lanyards for holding badges

Class 24

(11) fabric and textile products, namely, beach towels, billiard cloths, blankets, cloth banners, cloth flags, pennants made of textile, bed sheets, pillow cases

Class 25

(12) clothing, namely, bandanas, beach cover-ups, belts, body suits, boxer shorts, caps, cloth bibs, coats, dresses, ear muffs, gloves, hats, headbands, hosiery, housecoats, jackets, hockey jerseys,

leggings, leotards, men's dress suits and casual suits, mittens, nightshirts, pajamas, pants, rainwear, raincoats, robes, scarves, shirts, shorts, skirts, socks, sun visors, suspenders, sweaters, sweatpants, sweatshirts, swim trunks, swimsuits, ties, toques, t-shirts, underwear, vests, warm-up suits, wristbands; Shoes, boots, sandals, slippers and athletic shoes

Class 26

(13) hair accessories, ornamental novelty buttons, patches for clothing

Class 27

(14) carpets and carpet tiles, door mats, floor and vehicle mats, rugs, yoga mats

Class 28

(15) toys, games and sporting goods, namely, action figures, adhesive tape for hockey sticks, balloons, billiard/pool cue sticks, billiard/pool balls and triangles, board games, bobble head dolls, cheerleading pom-poms, checker sets, chess sets, Christmas stockings, Christmas tree ornaments, darts and dart boards, dolls; elbow pads, shin pads, knee pads and protective gloves for athletic use; field, street, in-line and roller hockey balls; flying discs, goalie masks for hockey, golf bags, golf balls, head covers for golf clubs; hand-held home video game machine, hockey pucks, hockey sticks, ice skate blade covers, ice skate blade guards, ice skates, inline and conventional roller skates, inflatable toys, jigsaw and manipulative puzzles, kites, marbles, novelty golf balls, novelty miniature goalie masks and hockey sticks, plastic toy canteens, plush animals, puppets, stuffed figurines and animals, suction cup stuffed toy animals, scale model vehicles, table top rod hockey games, toy airplanes, toy cars, toy trucks, toy hockey games, return tops, playing cards; children's inflatable swimming pools, inflatable swimming floats for children

Class 34

(16) cigarette lighters not of precious and non-precious metal

Services**Class 41**

entertainment services, namely arranging and conducting professional hockey exhibitions

Application Number 1,944,616
Language of Application English

Filing Date 2019-02-05

APPLICANT AND AGENT DETAILS

Applicant

National Hockey League
One Manhattan West
395 Ninth Avenue
New York, NY 10001
UNITED STATES OF AMERICA

Agent

BERESKIN & PARR LLP/S.E.N.C.R.L., S.R.L.
SCOTIA PLAZA, 40 KING STREET WEST,
40th FLOOR, TORONTO, ONTARIO, M5H3Y2

TRADEMARK DETAILS

NHL HERITAGE CLASSIC

Trademark Type

Word

Goods

Class 06

(1) goods of non-precious metals, namely, metal license plates, door knockers, metal road signs, trophies made of common metal, weather vanes

Class 09

(2) audio and video electronics, namely, electronic notebooks, electronic tablets, personal digital assistants, smart phones, cases/covers for personal digital assistants, electronic tablets and notebooks; stands for personal digital electronic devices, namely, personal digital assistants, cell phones, and MP3 players; cell phone chargers, cell phone face plates, ear phones, blank USB flash drives, blank DVDs, computer mouse and mouse pads, pre-recorded DVDs containing computer games in the field of the game of hockey; pre-recorded videotapes, audio tape recordings, DVDs containing movies, documentaries, and films in the field of the game of hockey; downloadable electronic audio and video publications, relating to the game of hockey, namely magazines, books, multimedia news podcasts and multimedia news webcasts, video and computer games, video game cartridges and discs, binoculars, decorative switch plate covers, eyewear, namely sports eyewear, eyeglasses, sunglasses, eyeglass chains and cords, decorative magnets, tape measures, docking stations for mobile phones and MP3 players, hand-held computer, protective helmets for sports, protective visors for athletic use, neon signs

Class 11

(3) night lights, electric lamps, lampshades, refrigerators, electronic toasters

Class 12

(4) spare tire covers, license plate frames and license plate holders

Class 14

(5) Items made of precious and non-precious metals, namely, commemorative coins and medals, trophies and key chains made of precious metals, jewelry, jewelry charms, earrings, medallions, rings, necklaces, tie tacks, pins in the nature of jewelry, watches and clocks, cuff links, key chain fobs, lanyards for holding keys

Class 16

(6) Printed matter and publications, namely, address books, adhesive labels, appointment books, framed artwork, autograph books, business card holders, book covers, book marks, booklets, books, bumper stickers, calendars, check books, coloring books, commemorative game tickets, decals, diaries, envelopes, erasers, flags and pennants of paper, game and souvenir programs concerning hockey, gift tags, gift wrapping paper, greeting cards, hand painted celluloids, lithographs, magazines, note pads, paintings, pamphlets, paper banners, paper napkins, paper towels, paperweights, pencil cases, pencil sharpeners, writing instruments, photograph albums, photographs (mounted and un-mounted), postcards, posters, printed paper signs, printed awards and certificates, printed schedules, drawing rulers, scrap books, serigraphs, paper doorknob hanger signs, stickers, sticker packs and sticker albums, trading cards and trading card albums, writing pads and writing paper, money clips

Class 18

(7) soft luggage and bags, namely, all-purpose sports and sports equipment bags, back packs, duffels, knapsacks, waist packs, gym bags, garment bags for travel, satchels, tote bags, wallets, key cases, luggage tags, billfolds, umbrellas

Class 20

(8) chairs, decorative mirrors, display cases, mirrors, picture frames, pillows, novelty license plates made of plastic, stools, tables, wall plaques made of plastic or wood, billiard/pool cue racks

Class 21

(9) Bottle openers, bowls, candy jars, coffee mugs, cups and saucers, cutting boards, drink coasters, drinking cups, drinking flasks, drinking glasses, glass bowls, glass figurines, glass pitchers, barbecue grill covers, kitchen utensils namely barbecue forks, barbecue spatulas and barbecue tongs; plates, salt and pepper shakers, garbage cans, water bottles, coin banks

Class 22

(10) lanyards for holding badges

Class 24

(11) fabric and textile products, namely, beach towels, billiard cloths, blankets, cloth banners, cloth flags, pennants made of textile, bed sheets, pillow cases

Class 25

(12) clothing, namely, bandanas, beach cover-ups, belts, body suits, boxer shorts, caps, cloth bibs, coats, dresses, ear muffs, gloves, hats, headbands, hosiery, housecoats, jackets, hockey jerseys, leggings, leotards, men's dress suits and casual suits, mittens, nightshirts, pajamas, pants, rainwear, raincoats, robes, scarves, shirts, shorts, skirts, socks, sun visors, suspenders, sweaters, sweatpants, sweatshirts, swim trunks, swimsuits, ties, toques, t-shirts, underwear, vests, warm-up suits, wristbands; Shoes, boots, sandals, slippers and athletic shoes

Class 26

(13) hair accessories, ornamental novelty buttons, patches for clothing

Class 27

(14) carpets and carpet tiles, door mats, floor and vehicle mats, rugs, yoga mats

Class 28

(15) toys, games and sporting goods, namely, action figures, adhesive tape for hockey sticks, balloons, billiard/pool cue sticks, billiard/pool balls and triangles, board games, bobble head dolls,

cheerleading pom-poms, checker sets, chess sets, Christmas stockings, Christmas tree ornaments, darts and dart boards, dolls; elbow pads, shin pads, knee pads and protective gloves for athletic use; field, street, in-line and roller hockey balls; flying discs, goalie masks for hockey, golf bags, golf balls, head covers for golf clubs; hand-held home video game machine, hockey pucks, hockey sticks, ice skate blade covers, ice skate blade guards, ice skates, inline and conventional roller skates, inflatable toys, jigsaw and manipulative puzzles, kites, marbles, novelty golf balls, novelty miniature goalie masks and hockey sticks, plastic toy canteens, plush animals, puppets, stuffed figurines and animals, suction cup stuffed toy animals, scale model vehicles, table top rod hockey games, toy airplanes, toy cars, toy trucks, toy hockey games, return tops, playing cards; children's inflatable swimming pools, inflatable swimming floats for children

Class 34

(16) cigarette lighters not of precious and non-precious metal

Services**Class 41**

entertainment services, namely arranging and conducting professional hockey exhibitions

Application Number 1,944,619
Language of Application English

Filing Date 2019-02-05

APPLICANT AND AGENT DETAILS

Applicant

National Hockey League
One Manhattan West
395 Ninth Avenue
New York, NY 10001
UNITED STATES OF AMERICA

Agent

BERESKIN & PARR LLP/S.E.N.C.R.L., S.R.L.
SCOTIA PLAZA, 40 KING STREET WEST,
40th FLOOR, TORONTO, ONTARIO, M5H3Y2

TRADEMARK DETAILS

Trademark Type

Design

Visual Representation



Goods

Class 06

(1) goods of non-precious metals, namely, metal license plates, door knockers, metal road signs, trophies made of common metal, weather vanes

Class 09

(2) audio and video electronics, namely, electronic notebooks, electronic tablets, personal digital assistants, smart phones, cases/covers for personal digital assistants, electronic tablets and notebooks; stands for personal digital electronic devices, namely, personal digital assistants, cell phones, and MP3 players; cell phone chargers, cell phone face plates, ear phones, blank USB flash drives, blank DVDs, computer mouse and mouse pads, pre-recorded DVDs containing computer games in the field of the game of hockey; pre-recorded videotapes, audio tape recordings, DVDs containing movies, documentaries, and films in the field of the game of hockey; downloadable electronic audio and video publications, relating to the game of hockey, namely magazines, books, multimedia news podcasts and multimedia news webcasts, video and computer games, video game cartridges and discs, binoculars, decorative switch plate covers,

eyewear, namely sports eyewear, eyeglasses, sunglasses, eyeglass chains and cords, decorative magnets, tape measures, docking stations for mobile phones and MP3 players, hand-held computer, protective helmets for sports, protective visors for athletic use, neon signs

Class 11

(3) night lights, electric lamps, lampshades, refrigerators, electronic toasters

Class 12

(4) spare tire covers, license plate frames and license plate holders

Class 14

(5) Items made of precious and non-precious metals, namely, commemorative coins and medals, trophies and key chains made of precious metals, jewelry, jewelry charms, earrings, medallions, rings, necklaces, tie tacks, pins in the nature of jewelry, watches and clocks, cuff links, key chain fobs, lanyards for holding keys

Class 16

(6) Printed matter and publications, namely, address books, adhesive labels, appointment books, framed artwork, autograph books, business card holders, book covers, book marks, booklets, books, bumper stickers, calendars, check books, coloring books, commemorative game tickets, decals, diaries, envelopes, erasers, flags and pennants of paper, game and souvenir programs concerning hockey, gift tags, gift wrapping paper, greeting cards, hand painted celluloids, lithographs, magazines, note pads, paintings, pamphlets, paper banners, paper napkins, paper towels, paperweights, pencil cases, pencil sharpeners, writing instruments, photograph albums, photographs (mounted and un-mounted), postcards, posters, printed paper signs, printed awards and certificates, printed schedules, drawing rulers, scrap books, serigraphs, paper doorknob hanger signs, stickers, sticker packs and sticker albums, trading cards and trading card albums, writing pads and writing paper, money clips

Class 18

(7) soft luggage and bags, namely, all-purpose sports and sports equipment bags, back packs, duffels, knapsacks, waist packs, gym bags, garment bags for travel, satchels, tote bags, wallets, key cases, luggage tags, billfolds, umbrellas

Class 20

(8) chairs, decorative mirrors, display cases, mirrors, picture frames, pillows, novelty license plates made of plastic, stools, tables, wall plaques made of plastic or wood, billiard/pool cue racks

Class 21

(9) Bottle openers, bowls, candy jars, coffee mugs, cups and saucers, cutting boards, drink coasters, drinking cups, drinking flasks, drinking glasses, glass bowls, glass figurines, glass pitchers, barbecue grill covers, kitchen utensils namely barbecue forks, barbecue spatulas and barbecue tongs; plates, salt and pepper shakers, garbage cans, water bottles, coin banks

Class 22

(10) lanyards for holding badges

Class 24

(11) fabric and textile products, namely, beach towels, billiard cloths, blankets, cloth banners, cloth flags, pennants made of textile, bed sheets, pillow cases

Class 25

(12) clothing, namely, bandanas, beach cover-ups, belts, body suits, boxer shorts, caps, cloth bibs, coats, dresses, ear muffs, gloves, hats, headbands, hosiery, housecoats, jackets, hockey jerseys, leggings, leotards, men's dress suits and casual suits, mittens, nightshirts, pajamas, pants, rainwear, raincoats, robes, scarves, shirts, shorts, skirts, socks, sun visors, suspenders, sweaters, sweatpants, sweatshirts, swim trunks, swimsuits, ties, toques, t-shirts, underwear, vests, warm-up suits, wristbands; Shoes, boots, sandals, slippers and athletic shoes

Class 26

(13) hair accessories, ornamental novelty buttons, patches for clothing

Class 27

(14) carpets and carpet tiles, door mats, floor and vehicle mats, rugs, yoga mats

Class 28

(15) toys, games and sporting goods, namely, action figures, adhesive tape for hockey sticks, balloons, billiard/pool cue sticks, billiard/pool balls and triangles, board games, bobble head dolls, cheerleading pom-poms, checker sets, chess sets, Christmas stockings, Christmas tree ornaments, darts and dart boards, dolls; elbow pads, shin pads, knee pads and protective gloves for athletic use; field, street, in-line and roller hockey balls; flying discs, goalie masks for hockey, golf bags, golf balls, head covers for golf clubs; hand-held home video game machine, hockey pucks, hockey sticks, ice skate blade covers, ice skate blade guards, ice skates, inline and conventional roller skates, inflatable toys, jigsaw and manipulative puzzles, kites, marbles, novelty golf balls, novelty miniature goalie masks and hockey sticks, plastic toy canteens, plush animals, puppets, stuffed figurines and animals, suction cup stuffed toy animals, scale model vehicles, table top rod hockey games, toy airplanes, toy cars, toy trucks, toy hockey games, return tops, playing cards; children's inflatable swimming pools, inflatable swimming floats for children

Class 34

(16) cigarette lighters not of precious and non-precious metal

Services**Class 41**

entertainment services, namely arranging and conducting professional hockey exhibitions

Application Number 1,944,622
Language of Application English

Filing Date 2019-02-05

APPLICANT AND AGENT DETAILS

Applicant

National Hockey League
One Manhattan West
395 Ninth Avenue
New York, NY 10001
UNITED STATES OF AMERICA

Agent

BERESKIN & PARR LLP/S.E.N.C.R.L., S.R.L.
SCOTIA PLAZA, 40 KING STREET WEST,
40th FLOOR, TORONTO, ONTARIO, M5H3Y2

TRADEMARK DETAILS

Trademark Type

Design

Visual Representation



Goods

Class 06

(1) goods of non-precious metals, namely, metal license plates, door knockers, metal road signs, trophies made of common metal, weather vanes

Class 09

(2) audio and video electronics, namely, electronic notebooks, electronic tablets, personal digital assistants, smart phones, cases/covers for personal digital assistants, electronic tablets and notebooks; stands for personal digital electronic devices, namely, personal digital assistants, cell phones, and MP3 players; cell phone chargers, cell phone face plates, ear phones, blank USB flash drives, blank DVDs, computer mouse and mouse pads, pre-recorded DVDs containing computer games in the field of the game of hockey; pre-recorded videotapes, audio tape recordings, DVDs containing movies, documentaries, and films in the field of the game of hockey; downloadable electronic audio and video publications, relating to the game of hockey, namely magazines, books, multimedia news podcasts and multimedia news webcasts, video and computer games, video game cartridges and discs, binoculars, decorative switch plate covers, eyewear, namely sports eyewear, eyeglasses, sunglasses, eyeglass chains and cords, decorative magnets, tape measures, docking stations for mobile phones and MP3 players, hand-held computer, protective helmets for sports, protective visors for athletic use, neon signs

Class 11

(3) night lights, electric lamps, lampshades, refrigerators, electronic toasters

Class 12

(4) spare tire covers, license plate frames and license plate holders

Class 14

(5) Items made of precious and non-precious metals, namely, commemorative coins and medals, trophies and key chains made of precious metals, jewelry, jewelry charms, earrings, medallions, rings, necklaces, tie tacks, pins in the nature of jewelry, watches and clocks, cuff links, key chain fobs, lanyards for holding keys

Class 16

(6) Printed matter and publications, namely, address books, adhesive labels, appointment books, framed artwork, autograph books, business card holders, book covers, book marks, booklets, books, bumper stickers, calendars, check books, coloring books, commemorative game tickets, decals, diaries, envelopes, erasers, flags and pennants of paper, game and souvenir programs concerning hockey, gift tags, gift wrapping paper, greeting cards, hand painted celluloids, lithographs, magazines, note pads, paintings, pamphlets, paper banners, paper napkins, paper towels, paperweights, pencil cases, pencil sharpeners, writing instruments, photograph albums, photographs (mounted and un-mounted), postcards, posters, printed paper signs, printed awards and certificates, printed schedules, drawing rulers, scrap books, serigraphs, paper doorknob hanger signs, stickers, sticker packs and sticker albums, trading cards and trading card albums, writing pads and writing paper, money clips

Class 18

(7) soft luggage and bags, namely, all-purpose sports and sports equipment bags, back packs, duffels, knapsacks, waist packs, gym bags, garment bags for travel, satchels, tote bags, wallets, key cases, luggage tags, billfolds, umbrellas

Class 20

(8) chairs, decorative mirrors, display cases, mirrors, picture frames, pillows, novelty license plates made of plastic, stools, tables, wall plaques made of plastic or wood, billiard/pool cue racks

Class 21

(9) Bottle openers, bowls, candy jars, coffee mugs, cups and saucers, cutting boards, drink coasters, drinking cups, drinking flasks, drinking glasses, glass bowls, glass figurines, glass pitchers, barbecue grill covers, kitchen utensils namely barbecue forks, barbecue spatulas and barbecue tongs; plates, salt and pepper shakers, garbage cans, water bottles, coin banks

Class 22

(10) lanyards for holding badges

Class 24

(11) fabric and textile products, namely, beach towels, billiard cloths, blankets, cloth banners, cloth flags, pennants made of textile, bed sheets, pillow cases

Class 25

(12) clothing, namely, bandanas, beach cover-ups, belts, body suits, boxer shorts, caps, cloth bibs, coats, dresses, ear muffs, gloves, hats, headbands, hosiery, housecoats, jackets, hockey jerseys, leggings, leotards, men's dress suits and casual suits, mittens, nightshirts, pajamas, pants, rainwear, raincoats, robes, scarves, shirts, shorts, skirts, socks, sun visors, suspenders, sweaters, sweatpants, sweatshirts, swim trunks, swimsuits, ties, toques, t-shirts, underwear, vests, warm-up suits, wristbands; Shoes, boots, sandals, slippers and athletic shoes

Class 26

(13) hair accessories, ornamental novelty buttons, patches for clothing

Class 27

(14) carpets and carpet tiles, door mats, floor and vehicle mats, rugs, yoga mats

Class 28

(15) toys, games and sporting goods, namely, action figures, adhesive tape for hockey sticks, balloons, billiard/pool cue sticks, billiard/pool balls and triangles, board games, bobble head dolls, cheerleading pom-poms, checker sets, chess sets, Christmas stockings, Christmas tree ornaments, darts and dart boards, dolls; elbow pads, shin pads, knee pads and protective gloves for athletic use; field, street, in-line and roller hockey balls; flying discs, goalie masks for hockey, golf bags, golf balls, head covers for golf clubs; hand-held home video game machine, hockey pucks, hockey sticks, ice skate blade covers, ice skate blade guards, ice skates, inline and conventional roller skates, inflatable toys, jigsaw and manipulative puzzles, kites, marbles, novelty golf balls, novelty miniature goalie masks and hockey sticks, plastic toy canteens, plush animals, puppets, stuffed figurines and animals, suction cup stuffed toy animals, scale model vehicles, table top rod hockey games, toy airplanes, toy cars, toy trucks, toy hockey games, return tops, playing cards; children's inflatable swimming pools, inflatable swimming floats for children

Class 34

(16) cigarette lighters not of precious and non-precious metal

Services**Class 41**

entertainment services, namely arranging and conducting professional hockey exhibitions

Application Number 1,944,637
Language of Application English

Filing Date 2019-02-05

APPLICANT AND AGENT DETAILS

Applicant

Holland America Line - USA Inc.
300 Elliott Avenue West
Seattle, WA 98119
UNITED STATES OF AMERICA

Agent

BERESKIN & PARR LLP/S.E.N.C.R.L., S.R.L.
SCOTIA PLAZA, 40 KING STREET WEST,
40th FLOOR, TORONTO, ONTARIO, M5H3Y2

TRADEMARK DETAILS

COMMITTED TO YOUR SUCCESS

Trademark Type

Word

Services

Class 39

Travel information services; cruise ship services; arranging of transportation for travel tours; organization of travel, cruise ship services.

Application Number 1,944,642
Language of Application English

Filing Date 2019-02-05

APPLICANT AND AGENT DETAILS

Applicant

FERNLEA FLOWERS LIMITED
P.O. Box 128
Delhi
ONTARIO
N4B2W9

Agent

WILSON LUE LLP
250 University Avenue, 5th Floor, Toronto,
ONTARIO, M5H3E5

TRADEMARK DETAILS

SAMBA

Trademark Type

Word

Goods

Class 31

Living plants, namely, dipladenia and mandevilla.

Application Number 1,944,643
Language of Application English

Filing Date 2019-02-05

APPLICANT AND AGENT DETAILS

Applicant

FLOYD DUNFORD LIMITED
366 Bay Street
Suite 1100
Toronto
ONTARIO
M5H4B2

Agent

CASSELS BROCK & BLACKWELL LLP
SCOTIA PLAZA, SUITE 2100, 40 KING
STREET WEST, TORONTO, ONTARIO,
M5H3C2

TRADEMARK DETAILS

BIG SKY MUSIC FESTIVAL

Trademark Type

Word

Goods

Class 09

(1) Covers and protective skins for cell phones, personal digital assistants and laptops.

Class 14

(2) Key chains.

Class 15

(3) Guitar picks.

Class 18

(4) Luggage and all-purpose carrying bags; umbrellas and parasols; collars, leashes and clothing for pets.

Class 20

(5) Outdoor furniture.

Class 21

(6) Souvenirs, namely bottle openers, drinking glassware of glass and acrylic.

Class 25

(7) Clothing, namely short sleeve t-shirts, long sleeve t-shirts, tank tops, sweatshirts (hooded and non-hooded), baby jumpers, namely bodysuits for infants and children, baseball hats, and toques.

Class 26

(8) Belt buckles.

Services

Class 35

(1) Promotion of concert tours for third parties, namely promoting musical entertainment events by soliciting and arranging for sponsors to affiliate their goods and services with such entertainment events for a fee, and promotion of third party concerts through advertising via radio, television, magazines, newspapers, flyers, brochures, posters and printed material.

Class 39

(2) Transportation of passengers by road, namely by bus, coach, and car.

Class 41

(3) Production and distribution of television programs; production and distribution of documentaries.

(4) Arranging, conducting, organizing and management of music festivals, music concerts and concert tours; concert booking services; sale of concert tickets.

Class 43

(5) Reservation of camp grounds and accommodations for travelers, namely tents and tent campsites, recreational vehicle sites, recreational vehicles, and hotel accommodations; providing temporary accommodations for travelers, namely tent campsites, recreational vehicle sites, and recreational vehicles.

Application Number 1,944,652
Language of Application English

Filing Date 2019-02-05

APPLICANT AND AGENT DETAILS

Applicant

The Alliance for Climate Protection
750 9th Street, NW
Suite 520
Washington, DC 20001
UNITED STATES OF AMERICA

Agent

DENTONS CANADA LLP
99 BANK STREET, SUITE 1420, OTTAWA,
ONTARIO, K1P1H4

TRADEMARK DETAILS

CLIMATE REALITY

Trademark Type

Word

Disclaimer

The right to the exclusive use of the word CLIMATE is disclaimed apart from the trademark.

Services

Class 35

(1) Promoting public awareness on the climate crisis, including global warming, climate change, environmental issues and the various types of solutions to the climate crisis; promoting public awareness of the climate crisis, including global warming, climate change, environmental issues and the various types of solutions to the climate crisis by means of public advocacy; public policy research services; charitable services, namely, organizing and conducting volunteer programs and community service projects

Class 41

(2) Educational services, namely, organizing and conducting classes, courses, conferences, workshops, seminars and cultural activities that promote education and awareness about the climate crisis, including climate change, global warming, and environmental issues and the various types of solutions to the climate crisis

Class 42

(3) Providing scientific information in the field of climate change, global warming and environmental issues, and possible solutions to those problems

Claims

Priority Filing Date: August 06, 2018, Country or Office: UNITED STATES OF AMERICA,
Application No: 88/066210 in association with the same kind of services

Application Number 1,944,655
Language of Application English

Filing Date 2019-02-05

APPLICANT AND AGENT DETAILS

Applicant

Seiko Holdings Kabushiki Kaisha (trading as
Seiko Holdings Corporation)
5-11, Ginza 4-chome, Chuo-ku
Tokyo
JAPAN

Agent

BORDEN LADNER GERVAIS LLP
World Exchange Plaza, 100 Queen Street,
Suite 1300, Ottawa, ONTARIO, K1P1J9

TRADEMARK DETAILS

PRESAGE COCKTAIL TIME

Trademark Type

Word

Goods

Class 14

watches, stopwatches, cases and parts for all the aforesaid goods

Application Number 1,944,731
Language of Application English

Filing Date 2019-02-06

APPLICANT AND AGENT DETAILS

Applicant

LAYFIELD GROUP LTD.
11131 Hammersmith Gate
Richmond
BRITISH COLUMBIA
V7A5E6

Agent

NATHAN WOODRUFF
200 - 10328 81 Avenue NW, Edmonton,
ALBERTA, T6E1X2

TRADEMARK DETAILS

4 FLEX

Trademark Type

Word

Goods

Class 16

Recyclable flexible film for packaging.

Application Number 1,944,750
Language of Application English

Filing Date 2019-02-06

APPLICANT AND AGENT DETAILS

Applicant

Medline Industries, LP
Three Lakes Drive
Northfield, IL 60093
UNITED STATES OF AMERICA

Agent

DEETH WILLIAMS WALL LLP
150 YORK STREET, SUITE 400, TORONTO,
ONTARIO, M5H3S5

TRADEMARK DETAILS

Trademark Type

Design

Visual Representation



Colour Claim

Colour is claimed as a feature of the trademark. The colors gray and red are claimed as a feature of the mark. The mark consists of the word 'CORIUS' in stylized font in gray with two diagonally connected dots in red over the letter 'i'. On the line below appears the wording 'TISSUE REGENERATION' in stylized font in gray.

Goods

Class 05

(1) Medical preparations for tissue regeneration

Class 10

(2) Medical apparatus to assist in tissue regeneration

Class 16

(3) Printed material, namely, manuals, information sheets and newsletters in the field of tissue regeneration

Services

Class 41

Educational services, namely, providing courses in the field of tissue regeneration

Claims

Priority Filing Date: August 21, 2018, Country or Office: UNITED STATES OF AMERICA,
Application No: 88/085,916 in association with the same kind of goods and in association with the
same kind of services

Application Number 1,944,757
Language of Application English

Filing Date 2019-02-06

APPLICANT AND AGENT DETAILS

Applicant

INITIUM COMMERCE LAB INC.
2443 Orchard Rd
Burlington
ONTARIO
L7L6X8

Agent

RICHARD UDITSKY
(ROBINSON SHEPPARD SHAPIRO S.E.N.C.
R.L./L.L.P.), 800 Place Victoria , Suite 4600 ,
Montreal, QUEBEC, H4Z1H6

TRADEMARK DETAILS

INITIUM

Trademark Type

Word

Services

Class 42

retail technology analysis services, namely providing an internet based application to which retailers will link online and offline business data to evaluate the total cost of ownership of their existing technology systems and obtain comparative information for the selection and procurement of retail technology systems so as to enable retailers to better understand their operating margins and thereby optimize their operations

Application Number 1,944,780
Language of Application English

Filing Date 2019-02-06

APPLICANT AND AGENT DETAILS

Applicant

Spunky Food Co., Ltd
19/56 Moo 10 Klongnueng Klongluang
12120
Pathumthani
THAILAND

Agent

BENOÎT & CÔTÉ INC.
560 boul. Crémazie Est, 3e étage, Montréal,
QUEBEC, H2P1E8

TRADEMARK DETAILS

Trademark Type

Design

Visual Representation



Colour Claim

Colour is claimed as a feature of the trademark. The colours red, green and black are claimed as a feature of the mark. The mark consists of a circular figure divided equally in red and green sections separated by a transparent area representing a letter S. The words SPUNKY FOOD appear below with the letters S in red and the letter F in green. All other letters are in colour black.

Goods

Class 29

Crispy fish; Fermented fish; Crispy shallots; Edible insects, not alive; Sundried beef.

Claims

Priority Filing Date: August 31, 2018, Country or Office: HONG KONG, Application No: 304653342 in association with the same kind of goods

Application Number 1,944,783
Language of Application English

Filing Date 2019-02-06

APPLICANT AND AGENT DETAILS

Applicant

Medtronic Bakken Research Center, B.V.
Endepolsdomein 5
Maastricht, 6229GW
NETHERLANDS

Agent

SMART & BIGGAR LLP
SUITE 900, 55 METCALFE STREET, P.O.
BOX 2999, STATION D, OTTAWA, ONTARIO,
K1P5Y6

TRADEMARK DETAILS

SURETUNE

Trademark Type

Word

Goods

Class 09

Software for medical applications, namely, software for use in connection with the implantation of and use in controlling neurostimulation pulse generators and probes for neurostimulation.

Application Number 1,944,795
Language of Application English

Filing Date 2019-02-06

APPLICANT DETAILS

Applicant

Diplomatico Branding, Unipessoal LDA
Rua do Esmeraldo, n.º 47, 3º floor
9000-051 Funchal (Madeira)
PORTUGAL

TRADEMARK DETAILS

DIPLOMATICO THE HEART OF RUM

Trademark Type

Word

Foreign Character Translation

The English translation of the word DIPLOMATICO is DIPLOMATIC.

Goods

Class 33

rum and rum liquors

Application Number 1,944,841
Language of Application English

Filing Date 2019-02-06

APPLICANT AND AGENT DETAILS

Applicant

Medline Industries, LP
Three Lakes Drive
Northfield, IL 60093
UNITED STATES OF AMERICA

Agent

DEETH WILLIAMS WALL LLP
150 YORK STREET, SUITE 400, TORONTO,
ONTARIO, M5H3S5

TRADEMARK DETAILS

THERMOGENIX

Trademark Type

Word

Goods

Class 10

Cooling technology consisting of graphite infused into foam used in mattresses, mattress covers and overlays, chair covers, seat cushions, operating room table pads, stretcher pads and heel boots, for medical purposes

Application Number 1,944,844
Language of Application English

Filing Date 2019-02-06

APPLICANT AND AGENT DETAILS

Applicant

Tiffin Motor Homes, Inc.
105 2nd Street NW
Red Bay, AL 35582
UNITED STATES OF AMERICA

Agent

LONNIE BRODKIN-SCHNEIDER
(MILLER THOMSON LLP), 1000, rue de la
Gauchetière Ouest, bureau 3700, Montréal,
QUEBEC, H3B4W5

TRADEMARK DETAILS

ALLEGRO BUS XSP

Trademark Type

Word

Goods

Class 12

motor homes

Claims

Priority Filing Date: February 01, 2019, Country or Office: UNITED STATES OF AMERICA,
Application No: 88/286125 in association with the same kind of goods

Application Number 1,944,848
Language of Application English

Filing Date 2019-02-06

APPLICANT AND AGENT DETAILS

Applicant

Coltene/Whaledent, Inc.
235 Ascot Parkway
Cuyahoga Falls, OH 44223
UNITED STATES OF AMERICA

Agent

OSLER, HOSKIN & HARCOURT LLP
SUITE 6200, P.O. BOX 50, 1 FIRST
CANADIAN PLACE, TORONTO, ONTARIO,
M5X1B8

TRADEMARK DETAILS

ENDO ICE

Trademark Type

Word

Goods

Class 05

Dental refrigerant spray to test tooth vitality

Claims

Priority Filing Date: October 30, 2018, Country or Office: UNITED STATES OF AMERICA,
Application No: 88/174,976 in association with the same kind of goods

Application Number 1,944,849
Language of Application English

Filing Date 2019-02-06

APPLICANT AND AGENT DETAILS

Applicant

Medline Industries, LP
Three Lakes Drive
Northfield, IL 60093
UNITED STATES OF AMERICA

Agent

DEETH WILLIAMS WALL LLP
150 YORK STREET, SUITE 400, TORONTO,
ONTARIO, M5H3S5

TRADEMARK DETAILS

SUREPREP

Trademark Type

Word

Goods

Class 05

Protective barrier wipe treated with a coating that bonds to the skin, used with medical tape, gloves, and other medical protective products, to improve adhesion of these items to the skin

Application Number 1,944,851
Language of Application English

Filing Date 2019-02-06

APPLICANT AND AGENT DETAILS

Applicant

Northern Response International Limited
50 Staples Ave., Unit #2
Richmond Hill
ONTARIO
L4B0A7

Agent

RIDOUT & MAYBEE LLP
250 University Avenue, 5th Floor, Toronto,
ONTARIO, M5H3E5

TRADEMARK DETAILS

CAFÉ MAGIC

Trademark Type

Word

Goods

Class 21

Hand tool for decorating cakes and brewed coffee

Application Number 1,944,860
Language of Application English

Filing Date 2019-02-06

APPLICANT AND AGENT DETAILS

Applicant

The Bay Limited Partnership
401 Bay Street, Suite 500
Toronto
ONTARIO
M5H2Y4

Agent

BERESKIN & PARR LLP/S.E.N.C.R.L., S.R.L.
SCOTIA PLAZA, 40 KING STREET WEST,
40th FLOOR, TORONTO, ONTARIO, M5H3Y2

TRADEMARK DETAILS

Trademark Type

Design

Visual Representation



Goods

Class 18

(1) Handbags, purses, leather bags and shoulder bags; carry-all bags; travel bags

Class 25

(2) Clothing, namely, shirts, t-shirts, knitted tops, blouses, blazers, jackets, suits, sweaters, vests, sweatshirts, sweat pants, dresses, skirts, pants, jeans, loungewear, leggings, coats, socks, ties, underwear, rainwear, athletic clothing, outerwear, sleepwear and intimate wear; scarves; gloves; belts; footwear, namely, shoes, boots, sandals, slippers, casual shoes, dress shoes, sneakers shoes; headwear, namely, caps, head bands, toques and hats

Application Number 1,944,862
Language of Application English

Filing Date 2019-02-06

APPLICANT AND AGENT DETAILS

Applicant

Speax Inc.
1 St. Thomas Street, Suite 17B
Toronto
ONTARIO
M5S3M5

Agent

NORTON ROSE FULBRIGHT CANADA LLP/S.
E.N.C.R.L.,S.R.L.
1, Place Ville Marie, Suite 2500, Montreal,
QUEBEC, H3B1R1

TRADEMARK DETAILS

Trademark Type

Design

Visual Representation



Goods

Class 09

Downloadable software and mobile application for interactive instructional language training.

Services

Class 41

Providing language training through a website; language training services

Application Number 1,944,901
Language of Application English

Filing Date 2019-02-06

APPLICANT DETAILS

Applicant

Agrimetis, LLC
10751 Falls Road, Suite 300
Lutherville, MD 21093
UNITED STATES OF AMERICA

TRADEMARK DETAILS

AGRIMETIS

Trademark Type

Word

Services

Class 42

Scientific research and development in the field of agriculture

Application Number 1,945,419
Language of Application French

Filing Date 2019-02-08

APPLICANT DETAILS

Applicant
Steve Robert
21 Rue Reid
Châteauguay
QUÉBEC
J6J2N4

TRADEMARK DETAILS

YMARKETING

Trademark Type
Word

Services

Class 35

Artistic agency.

Application Number 1,945,839
Language of Application French

Filing Date 2019-02-12

APPLICANT AND AGENT DETAILS

Applicant

1, 2, 3... je cuisine!
4320 Av Madison
Montréal
QUÉBEC
H4B2V2

Agent

STÉPHANIE THURBER
(Cain Lamarre S.E.N.C.R.L.), 630, boul. René-
Lévesque Ouest, bureau 2780, Montréal,
QUÉBEC, H3B1S6

TRADEMARK DETAILS

C'EST MOI LE CHEF!

Trademark Type

Word

Services

Class 41

(1) Education and training services intended to promote culinary practices and healthy eating habits for children and their families, offered via cooking workshops, training workshops on nutrition, and food tasting and discovery workshops.

Class 43

(2) Consulting service related to the culinary arts.

Class 44

(3) Consulting service related to nutrition.

Application Number 1,945,924
Language of Application English

Filing Date 2019-02-13

APPLICANT AND AGENT DETAILS

Applicant

Diamonds Direct Incorporated
1 Yorkdale Road, Suite 402
Toronto
ONTARIO
M6A3A1

Agent

CPST INTELLECTUAL PROPERTY INC.
130 Queens Quay East, East Tower, Suite
809, Toronto, ONTARIO, M5A0P6

TRADEMARK DETAILS

WATCHES DIRECT

Trademark Type

Word

Goods

Class 14

jewellery and watches

Services

Class 35

retail sale of jewellery and watches; jewellery and watch consulting services, namely, providing consumer product information and advice in the field of jewellery and watch products

Application Number 1,946,630
Language of Application English

Filing Date 2019-02-18

APPLICANT DETAILS

Applicant

Trust Trading Group (Imad Itani 95%, Najwa Ahmad 2.5%, Fawzi Itani 2.5% Partnership)
Kournish El Mazraa, Al Jazira Bldg, 4th Floor
Beirut
LEBANON

TRADEMARK DETAILS

CEDAR ROOTS

Trademark Type

Design

Colour Claim

Colour is claimed as a feature of the trademark. The background of the logo without the lower part is in Red. The cedar tree is shown in Gold and the frame of the logo without the lower part is in Gold too. The phrase "CEDAR ROOTS" and the phrase "FOODS COMPANY" are written in white color. The lower part of the logo is in green.

Goods

Class 29

(1) abalones; acidophilus milk; ajvar [preserved peppers]; albumen for culinary purposes; albumin milk; alginates for culinary purposes; almond butter; almond milk; almond milk for culinary purposes; almond milk-based beverages; aloe vera prepared for human consumption; anchovies; anchovy; anchovy fillets; anchovy paste; animal fats for food; animal marrow for food; animal oils and fats for food; animal oils for food; antipasto salads; apple butter; apple chips; apple compote; apple purée; apricot jam; ark-shells; aromatized fruit; artificial cream; artificial fish roes; artificial sausage skins; aspic; aubergine caviar; aubergine paste; bacon; bacon bits; baked beans; banana chips; bean curd; bean curd sticks; beancurd sticks; beans cooked in soy sauce [Kongjaban]; beef; beef bouillon; beef jerky; beef slices; beef stew; beef stock; beef tallow; beef tallow for food; black cherry jam; blackberry jam; blackcurrant jam; blended cheese; blended oil for food; blocks of boiled, smoked and then dried bonitos [katsuo-bushi]; blood sausage; blue cheese; blue mussels; blueberry jam; boiled and dried fish; bologna; bologna sausage; bone oil for food; bottled cooked meat; bottled fruits; bottled vegetables; bouillon; bouillon concentrates; bratwurst; broth; broth concentrates; bulgogi [Korean beef dish]; butter; butter cream; buttercream; buttermilk; cabbage rolls; cabbage rolls stuffed with meat; caesar salad; calamari in batter; camellia seed oil for food; candied almonds; candied fruit; candied nuts; candied pecans; cannabis oil for food; canned beef; canned carrots; canned chicken; canned chickpeas; canned cooked meat; canned cooked meats; canned fish; canned fruits; canned fruits and vegetables; canned green beans; canned mackerel; canned meat; canned meat spreads; canned olives; canned pineapple; canned pork; canned processed olives; canned seafood; canned snails; canned soups; canned sweet corn; canned tomatoes; canned tuna; canned vegetables; canola oil; canola oil for food; carp; cashew nut butter; caviar; cellulose food casings; century eggs; Chantilly cream; cheese; cheese containing herbs;

cheese containing spices; cheese dips; cheese in the form of dips; cheese powder; cheese rind; cheese spreads; cheese substitutes; cheonggukjang jjigae [Korean dish consisting primarily of tofu with rich soybean paste]; cherry jam; chicharron; chick peas; chicken; chicken breast fillets; chicken burger patties; chicken croquettes; chicken nuggets; chicken salad; chicken spreads; chicken stock; chicken wings; chili con carne; chocolate nut butter; chorizo; clam juice; clams; clarified butter; clotted cream; cocktail olives; cocktail onions; cocktail sausages; cocoa butter; cocoa butter for food; coconut butter; coconut fat; coconut milk; coconut milk beverages; coconut milk for culinary purposes; coconut milk powder; coconut milk-based beverages; coconut oil and fat for food; coconut oil for food; coconut powder; coconut shrimp; cod; codfish; coffee creamers; coleslaw; colza oil for food; compote; compotes; condensed milk; consommes; cooked dish consisting primarily of chicken and ginseng [samgyetang]; cooked dish consisting primarily of fermented vegetable, pork and tofu [kimchi-jjigae]; cooked dish consisting primarily of rich soybean paste and tofu [cheonggukjang-jjigae]; cooked dish consisting primarily of soybean paste and tofu [doenjang-jjigae]; cooked dish consisting primarily of stir-fried beef and fermented soy sauce [sogalbi]; cooked dish consisting primarily of stir-fried chicken and fermented hot pepper paste [dak-galbi]; cooked snails; cooking oil; corn dogs; corn oil for food; corned beef; cottage cheese; cottage cheese fritters; cow's milk; crab roe paste; crabs; crabwinch; cranberry compote; crayfish; cream cheese; creme fraiche; croquettes; crucian carps; crystallized fruit; crystallized fruits; crystallized gingers; cucumber kimchi [oi-sobagi]; curd; curdled milk; dairy cream; dairy cream powder; dairy curd; dairy products; dates; deep fried tofu; desiccated coconut; deviled eggs; dill pickles; doenjang jjigae [Korean dish consisting primarily of tofu with soybean paste]; dolmas; dried beans; dried beef; dried cranberries; dried dates; dried durians; dried edible black fungi; dried edible flowers; dried edible fungi; dried edible mushrooms; dried edible seaweed [hoshi-wakame]; dried edible tremella fuciformis; dried eggs; dried figs; dried fish; dried flakes of laver for sprinkling on rice in hot water [ochazuke-nori]; dried fruit; dried fruit and vegetables; dried fruit mixes; dried fruit-based snack bars; dried herring roe; dried lentils; dried mangoes; dried meat; dried milk for food; dried milk powder; dried mushrooms; dried olives; dried pawpaws; dried pears; dried persimmon [got-gam]; dried pieces of agar jelly (kanten); dried pineapple; dried pineapples; dried prawns; dried squid; dried truffles; dried vegetables; drinking yogurts; dry whey; duck eggs; edible ant larvae; edible bird's nests; edible birds' nests; edible bone oil; edible dried flowers; edible fats; edible frogs; edible insects; edible laver; edible oils; edible oils and edible fats; edible shavings of dried kelp (tororo-kombu); eels; egg whites; egg yolks; eggplant parmigiana; eggplant paste; eggs; evaporated milk; extra virgin olive oil; extra virgin olive oil for food; extracts for soups; extracts of meat; extracts of poultry; extra-virgin olive oil; falafel; fatty substances for the manufacture of edible fats; fermented bamboo shoots boiled and preserved in salt [menma]; fermented bean curd; fermented milk; fermented soybeans [natto]; fermented vegetables [kimchi]; fish; fish and meat preserves; fish croquettes; fish fillets; fish fingers; fish jelly; fish meal for human consumption; fish mousses; fish preserves; fish sausages; fish spreads; fish sticks; fishing crabs; fishmeal for human consumption; flaked hazelnuts; flakes of dried fish meat [kezuri-bushi]; flavored nuts; flavoured nuts; flaxseed oil for culinary purposes; flaxseed oil for food; foie gras; food casings; freeze-dried meat; freeze-dried tofu pieces (kohri-dofu); freeze-dried vegetables; french fries; fresh cheese; fresh unripened cheeses; fried chicken; fried meat; fried plantain; fried platano; fried potatoes; fried tofu pieces (abura-age); frosted fruits; frozen bamboo shoots; frozen brackens [Gosari]; frozen celery; frozen celery cabbages; frozen cherries; frozen cranberries; frozen eggs; frozen fish; frozen french fries; frozen fruits; frozen garlic; frozen meat; frozen meat dinners; frozen shellfish; frozen spinach; frozen strawberries; frozen vegetables; fruit and vegetable salads; fruit bars; fruit chips; fruit compotes; fruit fillings; fruit jam; fruit jellies; fruit jelly; fruit juices for cooking; fruit pectin for culinary purposes; fruit peel; fruit pie fillings; fruit preserved in alcohol; fruit preserves; fruit pulp; fruit purée; fruit salads; fruit salads and vegetable salads; fruit spreads; fruit topping; fruit-based

snack food; fruits preserved in alcohol; game; game meat; garlic butter; ghee; gherkins; ginger jam; goat milk; goat's cheese; grapeseed oil; grated potato nuggets; grilled meat dish [galbi]; grilled pork belly [samgyeopsal]; ground almond; ground beef; ground pork; gut for making black pudding; gut for making blood pudding; gut for making blood sausages; gut for making food casings; gut for making sausage casings; gut for making sausages; haggis; ham; hamburger patties; hardened oils for food; hash brown potatoes; hen eggs; herrings; honey butter; hors d'oeuvres; hot dog sausages; hot dogs; hummus; hummus chick pea paste; hydrogenated oil for food; instant frozen vegetables; instant mashed potato; instant miso soup; instant soup; instant stew; isinglass for food; jams; jams and marmalades; jellies and jams; jellies for food; jelly made from devils' tongue root (konnyaku); jelly powders; jerky; kale chips; kefir; kielbasa; kimchi [fermented vegetable dish]; kiwifruit flakes; knuckle of ham; kolbassa; lactic acid bacteria drinks; lactic acid drinks; lard; lard for food; lecithin for culinary purposes; legume salads; lemon curd; lemon juice for culinary purposes; lemon spread; linseed oil for culinary purposes; linseed oil for food; liver; liver pastes; liver pate; lobster; low fat dairy spreads; low-fat potato chips; low-fat potato crisps; lox; lyophilised vegetables; lyophilized meat; maize oil for food; margarine; marmalade; marmalades; marmalades and jams; mashed avocado; meat; meat and meat extracts; meat boiled down in soy sauce [tsukudani meat]; meat by-products; meat extracts; meat floss; meat jellies; meat jelly; meat preserves; meat purée; meat spreads; meat stocks; meatballs; milk; milk and milk products; milk beverages containing fruits; milk beverages with high milk content; milk curd; milk drinks containing fruits; milk of almonds for beverage; milk powder; milk powder for food purposes; milk powder for nutritional purposes; milk products; milk proteins; milk shakes; milk solids; milkshakes; mincemeat; mixed vegetables; mold-ripened cheese; mortadella; mould-ripened cheese; mullet roe salad; mushrooms puree; mussels; non-alcoholic eggnog; non-dairy creamers; nut topping; nut-based snack mixes; oat milk; octopuses; oils and fats for food; olive oil for food; olive oils; olive pastes; onion rings; organic milk; oysters; packaged meats; palm kernel oil for food; palm oil for food; paper-reinforced cellulose food casings; peach flakes; peach jam; peanut butter; peanut milk; peanut milk for culinary purposes; peanut milk-based beverages; peanut oil; peanut oil for food; pectin for culinary purposes; peeled tomatoes; perch; pickled cucumbers; pickled eggs; pickled fruits; pickled herrings; pickled hot peppers; pickled jalapenos; pickled onions; pickled peppers; pickled radishes; pickled shallots; pickled vegetables; pickled watermelon rind; pickles; pie fillings; pineapple jam; plaices; plum jam; poppy seed oil for culinary purposes; pork; pork rind; potato chips; potato crisps; potato crisps and chips; potato flakes; potato fritters; potato sticks; potato-based dumplings; poultry; poultry and game; powdered eggs; powdered milk; powdered milk for food purposes; powdered oils and fats for food; pre-cooked curry stew; pre-cooked miso soup; pre-cooked soup; pre-cooked stew; pre-cut vegetables for salads; preparations for making bouillon; preparations for making soup; prepared beef; prepared dishes consisting principally of meat; prepared escamoles; prepared escargot; prepared fish roe; prepared meals consisting principally of game; prepared meals primarily consisting of cooked fruits and vegetables; prepared meat; prepared pistachio; prepared salads; prepared snails; prepared stock; prepared stock for kitchen use; prepared sunflower seeds; prepared walnuts; preserved artichokes; preserved balloon flower root [Doraji]; preserved berries; preserved fruit and vegetables; preserved fruits; preserved garlic; preserved meat; preserved meats and sausages; preserved onions; preserved plums; preserved vegetables in oil; pressed fruit paste; processed olive puree; prostokvasha [soured milk]; protein for use as a food additive; protein for use as a food filler; protein milk; protein shakes; protein-enriched milk; puffed pork rind; quail eggs; raisins; rape oil for food; rapeseed oil for food; raspberry jam; red bean soup; red plum jam; red snapper; red snappers; rennet; rhubarb jam; rice bran oil for food; rice milk; rice milk for culinary purposes; ripened cheeses; roast beef; roasted garlic; roasted nuts; ryazhenka [fermented baked milk]; salami; salmon; salted eggs; salted fish; salted meats; salt-fermented sea urchin roe; sandwich spread; sardines; sauerkraut; sausage

casing; sausage casings; sausage meat; sausage skins made of natural gut; sausage skins made of synthetic materials; sausages; sausages in batter; sea basses; sea breams; sea cucumbers; sea salmon and trout roe; sea urchins; seafood; seafood spreads; seafoods boiled down in soy sauce [tsukudani]; seasoned laver [Jaban-gim]; seaweed extracts for food; seed butters; sesame oil for food; sheep cheese; sheep milk; sheep's milk; sheets of dried laver (hoshi-nori); shellfish; shellfish for human consumption; shepherd's pie; shish kebobs; shortening; short-necked clams; shrimps, prawns, and lobsters; silkworm chrysalis for human consumption; silver carp; sliced and seasoned barbecued beef [bulgogi]; smetana [sour cream]; smoked fish; smoked haddock; smoked mackerel; smoked meat; smoked meats; smoked salmon; smoked sausages; snack food dips; snail eggs for consumption; soft cheese; soft white cheese; soft-shelled turtles; soup; soup bases; soup concentrates; soup cubes; soup mixes; soup pastes; soups; soups and preparations for making soups; sour milk; soy bean oil for food; soy milk; soy sauce marinated crab [Ganjang-gejang]; soya bean oil for cooking; soya bean oil for food; soya milk; soya patties; soy-based beverage for use as a milk substitute; soy-based butter substitute; soy-based cheese substitute; soybean milk; soybean oil; soybean oil for cooking; spiced almonds; spicy beef broth [yukgaejang]; spicy pickles; steamed cakes of smashed fish and yam (hampen); steamed or toasted cakes of fish paste (kamaboko); stewed fruit; stock cubes; strained cheese; strained soft white cheeses; strawberry jam; sunflower oil for food; sunflower seeds; sweetfish; swordfish; tahini [sesame seed paste]; tempeh; textured vegetable protein; tinned fish; tinned fruits; tinned meat; tinned olives; tinned seafood; tinned tomatoes; tinned vegetables; toasted laver; toasted sheets of laver (yakinori); tofu; tofu patties; tofu skin; tomato extracts; tomato juice for cooking; tomato paste; tomato preserves; tomato purée; tripe; trout; truffle juice; tube-shaped toasted cakes of fish paste (chikuwa); tuna fish; tzatziki; unripened cheese; vegetable based spread; vegetable juices for cooking; vegetable marrow paste; vegetable mousses; vegetable oil for cooking; vegetable oils and fats for food; vegetable puree; vegetable salads; vegetable side dishes; vegetable soup preparations; vegetables in vinegar; vegetarian sausages; veggie burger patties; walnut kernels; wasabi-coated peanuts; whale fat for food; whale oil and fat for food; whales; whey; whipped cream; whipping cream; white cheese; white of eggs; wieners; yakitori; yaourt; yaourt drinks; yoghurt; yoghurt drinks; yoghurt; yoghurt drinks; yogourt; yogourt drinks; yogurt; yolk of eggs; yuca chips

Class 30

(2) acanthopanax tea; additives for use as food flavouring; adlay flour for food; agave syrup for use as a natural sweetener; alimentary pasta; alimentary paste; all-purpose flour; allspice; almond cake; almond cakes; almond confectionery; almond paste; angel-hair pasta; aniseed; apple cobbler; apple pie; apple pies; apple sauce; apricot pies; artificial coffee; artificial coffee and tea; asian apricot tea [maesilcha]; asian noodles; bagels; baguettes; baking chocolate; baking powder; baking soda; baking spices; baking-powder; balsamic vinegar; banana fritters; banana pudding; baozi [stuffed buns]; barbecue sauce; barley flour; barley meal; barley tea; bars of sweet jellied bean paste [Yohkan]; batter mixes for okonomiyaki [Japanese savory pancakes]; batter mixes for okonomiyaki [Japanese savoury pancakes]; bean jam buns; bean meal; bean-jam filled wafers [monaka]; bean-starch noodles [harusame, uncooked]; bee glue; beef pies; beer vinegar; beetroot chutney; beverage flavourings; beverages made of coffee; beverages made of tea; bicarbonate of soda for cooking purposes; binding agents for edible ices; binding agents for ice cream; biscotti; biscotti dough; biscuit mixes; biscuits; biscuits and bread; bittersweet chocolate; black tea; blueberry tarts; bonbons; bonbons made of sugar; bread; bread and buns; bread and pastry; bread baguettes; bread buns; bread containing psyllium; bread crumb; bread doughs; bread flavoured with spices; bread mixes; bread pudding; bread rolls; bread sticks; bread with soy bean; breadcrumbs; breadsticks; breakfast cereals; brine for cooking; brine for use in cocktails; brioches;

brittle; brown rice; brown sugar; brownie dough; brownie squares; brownies containing marijuana; bubble gum; buckwheat flour; buckwheat flour for food; buckwheat pancakes; buckwheat pasta; bulgur; buns; burritos; butter biscuits; buttermilk biscuits; butterscotch; butterscotch candies; butterscotch chips; caffeine-free coffee; cake batter; cake decorations made of candy; cake decorations made of edible rice paper; cake decorations made of edible wafer; cake decorations made of marzipan; cake decorations made of spun sugar; cake dough; cake doughs; cake frosting; cake icing; cake mixes; cake powder; cake sprinkles; cakes; cakes of sugar-bounded millet or popped rice [okoshi]; calzones; calzoni; candies; candy; candy bars; candy decorations for cakes; candy floss; candy for food; candy mints; candy with caramel; candy with cocoa; candy-coated apples; canned spaghetti in tomato sauce; cannelloni; capers; caramel popcorn; caramels; cassava crackers; castor sugar; celery salt; cereal bars; cereal-based bars; cereal-based snack food; chai tea; chamomile; chamomile-based beverages; cheese sauce; cheeseburger sandwiches; cheesecakes; cherry pies; chewing gum; chewing gum for breath freshening; chewing gums; chicken pies; chicory and chicory mixtures for use as coffee substitutes; chili oil for use as a seasoning or condiment; chili powder; chili sauce; chili seasonings; chimichanga; chimichangas; chimichurri sauce; Chinese rice noodles; Chinese rice noodles [bifun, uncooked]; Chinese steamed dumplings (shumai, cooked); Chinese stuffed dumplings; Chinese stuffed dumplings (gyoza, cooked); chocolate; chocolate and chocolates; chocolate bark containing ground coffee beans; chocolate bars; chocolate bars infused with cannabis; chocolate cake; chocolate cakes; chocolate candies; chocolate chip cookies; chocolate chips; chocolate confectionery; chocolate confections; chocolate covered nuts; chocolate covered pretzels; chocolate cupcakes; chocolate decorations for cakes; chocolate fondue; chocolate for confectionery and bread; chocolate mousses; chocolate pastes; chocolate sauce; chocolate spreads containing nuts; chocolate sprinkles; chocolate sprinkles for decorating cakes; chocolate syrup; chocolate syrups; chocolate topped pretzels; chocolate topping; chocolate with Japanese horseradish; chocolate-based meal replacement bars; chocolate-based spreads; chocolate-coated nuts; chocolate-covered nuts; chocolate-covered pretzels; chocolates filled with liqueur; chocolate-topped pretzels; chutney; chutney condiments; cinnamon; cinnamon powder; citron tea; clove powder; cocoa; cocoa extracts for human consumption; cocoa powder; cocoa spreads; cocoa that is granulated for drinks; cocoa-based beverages; coffee; coffee and artificial coffee; coffee and coffee substitutes; coffee and tea; coffee based beverages; coffee beverages with milk; coffee essences; coffee essences for use as substitutes for coffee; coffee extracts; coffee extracts for use as substitutes for coffee; coffee substitutes; coffee-based beverages; cones for ice cream; confectionery crystal sugar pieces; confectionery fondants; confectionery fruit jellies; confectionery fruit pastes; confectionery ices; cooked dish consisting primarily of dough flakes with broth [sujebi]; cooked dish consisting primarily of sliced oval rice cakes with broth [tteokguk]; cooked dish consisting primarily of stir-fried rice cake with fermented hot pepper paste [topokki]; cooked rice; cooked rice mixed with vegetables and beef [bibimbap]; cookies; cookies and crackers; cooking salt; corn chips; corn flakes; corn flour; corn flour for food; corn grits; corn meal; corn starch; corn starch flour; corn starch for food; corn syrup; corn-based snack food; cornflour; cornmeal; cotton candy; couscous; couscous semolina; crackers; cranberry sauce; cream buns; cream of tartar for culinary purposes; cream puffs; crepes; croissants; croutons; crumpets; crushed barley; crushed oats; cube sugar; currant bread; curry pastes; curry powder; curry powders; custard; danish bread; danish pastries; dessert mixes; dessert mousse; dessert puddings; donuts; dough; doughnuts; dressings for salad; dried bread crumbs; dried cooked-rice; dried coriander for use as seasoning; dried coriander seeds for use as seasoning; dried pasta; dried pieces of wheat gluten [uncooked fu]; dried sugared cakes of rice flour [rakugan]; dry instant pudding; dulce de leche; dumpling skins; Earl Grey tea; edible cake decorations; edible flour; edible food wafers; edible fruit ices; edible ices; edible rice paper; edible salt; edible spices; edible turmeric; edible wafers; empanada dough; empanadas;

enchiladas; energy bars; English cream; English muffins; English tea; fajitas; farina; farinaceous food pastes; farinaceous food pastes for human consumption; fermented hot pepper paste [gochujang]; fermenting malted rice [koji]; filled chocolate; filled chocolates; filled pasta; filo doughs; fish pies; fish sauce; flan base wafers; flapjacks; flat bread; flatbreads; flavored vinegars; flavoured vinegar; flavourings for butter; flavourings for cakes; flavourings for cheeses; flavourings for soups; flavourings of almond; flavourings of almond for food or beverages; flavourings of lemons; flavourings of lemons for food or beverages; flavourings of tea; flaxseed for culinary purposes; flaxseed for human consumption; flour; flour for food; flour for making dumplings of glutinous rice; flour-based dumplings; flowers or leaves for use as tea substitutes; focaccia bread; food flavourings; food seasonings; food stuffing mixes; frappes; freeze-dried dishes with main ingredient being pasta; freeze-dried dishes with main ingredient being rice; freeze-dried dishes with the main ingredient being pasta; freeze-dried dishes with the main ingredient being rice; French loaves; french toast; fresh pasta; fresh pizza; fresh pizzas; fried dough cookies [karintoh]; fried dough twists; frosting mixes; frozen confectionery; frozen cookie dough; frozen desserts; frozen flavoured waters; frozen yoghurt; frozen yoghurt cakes; frozen yoghurt pies; frozen yogurt cakes; frozen yogurt confections; frozen yogurt pies; frozen yogurt pies and cakes; fructose for food; fruit bread; fruit breads; fruit cakes; fruit flavourings; fruit ices; fruit jelly candy; fruit paste for flavouring of food; fruit pies; fruit sauce; fruit teas; fruit-based confectionery; garlic bread; garlic purée; gateaux; gimbap [Korean rice dish]; ginger tea; gingerbread; ginseng tea; glucose for culinary purposes; glucose for food; gluten for food; gluten-free bread; glutinous pounded rice cake coated with bean powder [injeolmi]; glutinous starch syrup [mizu-ame]; gnocchi; golden syrup; graham crackers; granola bars; granola-based snack bars; granola-based snack food; granulated coffee for drinks; granulated sugar; gravy sauce; green onion pancake [pajeon]; green tea; groats for human food; ground coffee beans; halvah; ham glaze; hamburger sandwiches; hardtack biscuits; herbal flavourings for making beverages; herbal honey; herbal tea beverages; herbal teas; herbs for food purposes; high-protein cereal bars; hominy; hominy grits; honey; honey and treacle; honey for food; honey substitutes; horseradish; hot chocolate; hot dog sandwiches; hot pepper powder; hot sauce; husked barley; husked oats; husked rice; ice; ice blocks; ice candies; ice cream; ice cream bars; ice cream cones; ice cream gateaux; ice cream mixes; ice cream powder; ice cream sandwiches; ice cubes; ice for refreshment; ice-cream; ice-cream cakes; iced cakes; iced coffee; iced tea; ices and ice creams; icing; icing mixes; instant Chinese noodles; instant coffee; instant dessert puddings; instant donut mixes; instant doughnut mixes; instant noodles; instant pancake mixes; instant pudding mixes; instant rice; instant soba noodles; instant tea; instant udon noodles; jam buns; Japanese arrowroot powder for food [kudzu-ko]; Japanese green tea; Japanese horseradish powder spice [wasabi powder]; Japanese pepper powder spice [sansho powder]; Japanese savory pancakes [okonomiyaki]; Japanese sponge cakes [kasuter]; Japanese style steamed cakes (mushi-gashi); jasmine tea; jelly beans; jiaozi [stuffed dumplings]; kasha; ketchup; ketchup sauce; kettle corn; kimchi pancakes [kimchijeon]; kimchijeon [fermented vegetable pancakes]; korean traditional pressed sweets in the form of cookies [dasik]; korean-style dried seaweed rolls containing cooked rice [gimbap]; korean-style dumplings [mandu]; lasagna; leaven; lime tea; linseed for culinary purposes; linseed for human consumption; liquorice; lollipops; lomper [potato-based flatbread]; low-salt bread; lyophilised dishes with main ingredient being pasta; lyophilised dishes with main ingredient being rice; lyophilised dishes with the main ingredient being pasta; lyophilised dishes with the main ingredient being rice; lyophilized dishes with main ingredient being pasta; lyophilized dishes with main ingredient being rice; lyophilized dishes with the main ingredient being pasta; lyophilized dishes with the main ingredient being rice; macaroni; macaroons; maize flakes; maize flour; maize meal; malt biscuits; malt extract for food; malt for human consumption; malt used as food flavouring; maltose; maltose for food; maple syrup; marinades; marshmallow; marshmallow topping; marshmallows; marzipan; marzipan

substitutes; mayonnaise; meat gravies; meat juice; meat pies; meat sauce; meat tenderizers for household purposes; meringues; milk chocolate; minced garlic; mincemeat pies; mint for confectionery; mints for breath freshening; mixes of sweet adzuki-bean jelly [mizu-yokan-no-moto]; mixtures of coffee and chicory; molasses; molasses for food; molasses syrup; moon cakes; muesli; muffin mixes; muffins; mulled barley; multigrain bread; mung bean pancakes [bindaetteok]; mustard; mustard meal; mustard powder; naan bread; nachos; natural sweeteners; non-alcoholic chocolate-based beverages; non-alcoholic coffee-based beverages; non-alcoholic tea-based beverages; non-confectionery crystal sugar; nonpareils; noodle-based prepared meals; noodles; nougat; nut flours; nutmegs; oat bran cereals; oat flakes; oatmeal; okonomiyaki [Japanese savoury pancakes]; onion biscuits and cheese biscuits; oolong tea; palm sugar; pancakes; panettone; pasta; pasta and noodles; pasta for soups; pasta sauce; pasta side dishes; pasta-wrappings for gyoza; pastries; pastry; pastry icing; pastry shells for monaka; peanut confectionery; pecan logs; pellet-shaped rice crackers [arare]; pelmeni [dumplings stuffed with meat]; pepper; pepper powder; pepper sauce; peppermint; peppermint candy; peppermint for confectionery; perilla powder for food; petit-beurre biscuits; petits fours cakes; phyllo dough; piccalilli; pickled ginger; pie crusts; pies; pita bread; pizza; pizza sauce; pizzas; popcorn; poppadums; popping corn; pork pies; potato flour; potato flour for food; pounded rice cakes [mochi]; pounded wheat; powder for edible ices; powdered cocoa for drinks; powdered coffee for drinks; powdered starch syrup for food; powdered sugar; powders for making ice cream; pralines; prawn crackers; preparations for stiffening whipped cream; prepared cocoa and cocoa-based beverages; prepared coffee and coffee-based beverages; prepared horseradish; prepared meat pies; prepared pasta; prepared pizzas; prepared ravioli; preserved garden herbs; processed garlic for use as seasoning; propolis; puddings; puffed rice; quesadillas; quiche; quiches; ramen [Japanese noodle-based dish]; ravioli; raw sugar; ready-to-eat cereals; red bean porridge [patjuk]; relishes; ribbon vermicelli; rice; rice ball [onigiri]; rice crackers [senbei]; rice dumplings dressed with sweet bean jam [ankoro]; rice flour; rice pudding; rice pulp for culinary purposes; rice side dishes; rice starch flour; rice-based snack food; risotto; roasted and ground sesame seeds; roasted cocoa for drinks; roasted coffee beans; roasted coffee for drinks; rolled oats and wheat; royal jelly; rusks; sage; sage tea; sago; sago palm starch for food; salad dressings; salad sauces; salt; salt and pepper; salt for preserving foodstuffs; salted biscuits; saltine crackers; sandwiches; sauce mixes; sauces for barbecued meat; sausage rolls; savarins; savoury and salted biscuits; savoury biscuits; sea salt; sea water for cooking; seasoned bean paste; seasoned salt; seasonings; semolina; senbei [rice crackers]; shaved ice with sweetened red beans; shaved ices with sweetened red beans; sherbet mixes; sherbets; shortbread biscuits; shrimp rolls; sloppy joe sauce; snack crackers; soba noodles; soda bread; soft pin-rolled cakes of pounded rice [gyuhi]; soft pretzels; sopapilla; sopapillas; sorbets; soy sauce; soya bean paste condiment; soya flour; soya sauce; soy-based ice-cream substitute; spaghetti; spaghetti sauce; spices; spices in the form of powders; sponge cakes; spring rolls; sriracha hot chili sauce; star aniseed; starch for food; starch syrup for food; starch-based candies (ame); steamed buns stuffed with minced meat [niku-manjuh]; steamed rice; steel cut oats; stir-fried noodles with vegetables [Japchae]; stir-fried rice; submarine sandwiches; sugar; sugar confectionery; sugar substitutes; sugar-coated coffee beans; sugar-coated hard caramels; sugared beans (ama-natto); sugar-free candies; sugar-free chewing gum; sugarcane chewing gum; sugarless candies; sugarless chewing gum; sushi; sweet bean jam coated with sugared-bean based soft shell [nerikiri]; sweet dumplings (dango); sweet potato starch for food; sweet pounded rice cakes [mochi-gashi]; sweet rice with nuts and jujubes [yaksik]; sweetened gelatin; sweetmeat made of sesame oil; sweets in the form of candy; tabbouleh; table salt; table salt mixed with sesame seeds; taco chips; taco shells; tacos; taffy; tapioca; tapioca flour for food; tartar sauce; tarts; tea; tea extracts; tea of parched powder of barley with husk (mugi-cha); tea of salty kelp powder (kombu-cha); tea substitutes; theine-free tea sweetened with sweeteners; thickening

agents for cooking; tiramisu; toast; toasted grain flour; toffee candies; toffees; tomato sauce; tortilla chips; tortillas; treacle; turbinado sugar; turmeric; turmeric for food; udon noodles; uncooked artificial rice; uncooked Chinese noodles; uncooked enriched rice; uncooked Japanese soba noodles of buckwheat; uncooked macaroni; uncooked somen wheat noodles; uncooked spaghetti; uncooked udon noodles; unleavened bread; unleavened bread in thin sheets; unroasted coffee; vanilla; vanilla flavorings; vanilla flavorings for culinary purposes; vanilla flavourings for culinary purposes; vareniki [stuffed dumplings]; vegan mayonnaise; vegetable preparations for use as coffee substitutes; vegetal preparations for use as coffee substitutes; vermicelli; vinegar; wafer doughs; waffles; wasabi; water ice; wheat flour; wheat flour for food; wheat germ; wheat germ for human consumption; wheat starch flour; wheat-based snack food; White lotus tea [Baengnyeoncha]; white sugar; whole wheat bread; wholemeal bread; wholemeal rice; wild rice; wine vinegar; wonton chips; worcestershire sauce; wrap sandwiches; yeast; yeast extracts; yeast extracts for food; yeast extracts for human consumption; yeast for use as an ingredient in foods; yeast powder

Class 31

(3) abrasive liners for cat litter boxes; abrasive liners for cat litter trays; agricultural seeds; algarovilla for animal consumption; aloe vera plants; animal bedding; animal embryos; animal feed; animal food pellets; animal litter; animal starter feed; apple tree seeds; aquarium fish; aquarium fish food flakes; aquarium fish food pellets; aquarium plants; aromatic sand litter for pets; arrangements of dried flowers; arrangements of dried flowers for decorative purposes; arrangements of fresh fruit; arrangements of natural flowers; barley; bearberry; bee pollen for industrial use; beverages for canines; beverages for cats; beverages for dogs; bilberry; bird food; bird seed; biscuits for animals; black cohosh; boutonnières of natural flowers; bran; bran mash for animal consumption; brine shrimp for fish food; brine shrimp for use as fish food; bulbs for agricultural purposes; bulbs for horticultural purposes; bushes; by-products of the processing of cereals, for animal consumption; by-products of the processing of cereals for animal consumption; cacti; cactuses; cakes of soy and cereal residue for animal consumption; calendula; canned cat food; canned dog food; cat biscuits; cat food; cat litter; cat litter and litter for small animals; cat litters; catmint; catnip; cats; cattle; cattle cake; cattle feed; cattle food; celery; cellulose for use as animal bedding; chicken feed; chicory roots; chopped straw for animal bedding; Christmas trees; coconut; coconut meal for animal consumption; coconut shell; coconuts; cocoons for egg production; cocoons for silkworm breeding; cola nuts; common bryony; copra; corms; corsages of natural flowers; crop seeds; cut christmas trees; cut flowers; cut live Christmas trees; cuttle bone for birds; cuttlebones for birds; digestible chewing bones for dogs; distillery waste for animal consumption; dog biscuits; dog chews; dog food; dogs; draff; dried boutonnières; dried cattails for decoration; dried corn husks for decoration; dried corsages; dried floral arrangements; dried flower arrangements; dried flower wreaths; dried flowers; dried flowers for decoration; dried herbs for decoration; dried plants for decoration; echinacea; edible bird treats; edible cat treats; edible chewing bones for dogs; edible chews for animals; edible chews for dogs; edible dog treats; edible horse treats; edible pet treats; edible treats for cats and dogs; edible treats for pets; eggs for hatching; elder trees; feed for livestock; fenugreek; fertilised eggs for hatching; fertilized eggs for hatching; fish food; fish meal animal feed; fish meal for animal consumption; fish spawn; fishmeal for animal consumption; flavourings for animal feed; flaxseed for animal consumption; flaxseed meal for animal consumption; floral centrepieces; flower bulbs; flower bulbs and corms; flower corms; flower seeds; flowering plants; fodder; food for aquarium fish; food for goldfish; food for hamsters; food for pets; food for rodents; food for sheep; forage; formula starter feed for calves; fresh acai berries; fresh adzuki beans; fresh almonds; fresh apple mangos; fresh apples; fresh apricots; fresh artichokes; fresh asparagus; fresh aubergines; fresh avocados; fresh baby corn;

fresh baechu [napa cabbage]; fresh balloon flower root [Doraji]; fresh bamboo shoots; fresh bananas; fresh basil; fresh bean sprouts; fresh beans; fresh beet; fresh beets; fresh berries; fresh betel nuts; fresh black currants; fresh black raspberry [bokbunja]; fresh blackberries; fresh blackcurrants; fresh blood oranges; fresh blueberries; fresh bok choy; fresh bokbunja [black raspberries]; fresh boysenberries; fresh Brazil nuts; fresh brussel sprouts; fresh brussels sprouts; fresh cabbage; fresh carambolas; fresh carrots; fresh cashew nuts; fresh cashews; fresh cassava roots; fresh chamoe [oriental melon]; fresh cherries; fresh cherry tomatoes; fresh chervil; fresh chestnuts; fresh chick peas; fresh chickpeas; fresh chicory; fresh chilies; fresh chillies; fresh chives; fresh cilantro; fresh citrus fruit; fresh clementines; fresh cloudberry; fresh coconuts; fresh cola nuts; fresh coriander; fresh corni fructus [Sansuyu] in the nature of live plants; fresh corsages; fresh courgettes; fresh cranberries; fresh cucumbers; fresh culinary herbs; fresh cut garlands; fresh cut wreaths; fresh dates; fresh doraji [balloon flower] roots; fresh dragon fruits; fresh durians; fresh edamame; fresh edible aloe vera; fresh edible flowers; fresh edible fungi; fresh edible mushrooms; fresh eggplants; fresh fern [gosari]; fresh figs; fresh flavoring leaves of Japanese pepper tree [Sansho]; fresh flower arrangements; fresh flowers; fresh fruit; fresh fruit and vegetables; fresh garbanzo beans; fresh garden herbs; fresh garlic; fresh ginger; fresh ginkgo nuts; fresh goji berries; fresh gooseberries; fresh grape tomatoes; fresh grapefruit; fresh grapefruits; fresh grapes; fresh green beans; fresh guavas; fresh hazelnuts; fresh herbs; fresh horseradish root; fresh jackfruit; fresh Japanese edible horseradishes [wasabi]; fresh japanese persimmons; fresh jicama; fresh kale; fresh kiwi fruit; fresh kohlrabi; fresh kumquats; fresh leeks; fresh legumes; fresh lemons; fresh lentils; fresh lettuce; fresh lichee; fresh lichees; fresh limes; fresh litchis; fresh loganberries; fresh loquats; fresh lychee; fresh lychees; fresh mandarin oranges; fresh mangoes; fresh mangos; fresh mangosteens; fresh manioc roots; fresh matsutake mushrooms; fresh melons; fresh microgreens; fresh mint; fresh mulberries; fresh mushrooms; fresh napa cabbage [baechu]; fresh noni fruit; fresh nuts; fresh oats; fresh onions; fresh oranges; fresh oregano; fresh oriental melon [cham-oe]; fresh papayas; fresh parsley; fresh passion fruit; fresh peaches; fresh peanuts; fresh pears; fresh peas; fresh pecans; fresh peppers; fresh perilla leaves (shiso); fresh pine nuts; fresh pineapples; fresh pistachio nuts; fresh pistachios; fresh plantains; fresh plum tomatoes; fresh plums; fresh pomegranate; fresh potatoes; fresh pulses; fresh pumpkins; fresh quinces; fresh rambutans; fresh raspberries; fresh red currants; fresh red kidney beans; fresh redcurrants; fresh rhubarb; fresh rosemary; fresh sage; fresh satsumas; fresh scallions; fresh shallots; fresh shiitake mushrooms; fresh spinach; fresh spring onions; fresh squashes; fresh strawberries; fresh string beans; fresh sugar beet; fresh sweet potatoes; fresh tangerines; fresh thyme; fresh tomatoes; fresh truffles; fresh vegetable marrows; fresh vegetables; fresh walnuts; fresh wasabi [Japanese edible horseradish]; fresh water chestnuts; fresh watermelon; fresh wheat; fresh wheatgrass; fresh wine grapes; fresh yams; fresh zucchini; fruit seeds; fruits and vegetables featuring apples, pears and carrots; garlands of natural flowers; gift baskets containing fresh fruits; gift baskets of fresh fruits; goldfish; goldfish food; grains for animal consumption; grains for planting; grass seed; grass seeds; grass sod; gravel paper for bird cages; gravel paper for birdcages; goats for poultry; hamster food; hamsters; hay; hay for use as Easter basket grass; hazelnuts; herbs for sachets; hop cones; hops; horse feed; horses; horticultural seeds; hyssop; juniper berries; kola nuts; lawn turf; lemons; lime for animal forage; linseed for animal consumption; linseed meal for animal consumption; litter for animals; litter for domestic animals; litter for small animals; litter peat; live abalones; live anchovies; live aquarium coral; live ark shells; live ark-shells; live bait; live bait for fishing; live baits; live blue mussels; live butterflies; live calamari; live cannabis plants; live carp; live Christmas trees; live clams; live cod; live codfishes; live coral; live crabs; live crawfish; live crayfish; live crucian carps; live cut christmas trees; live cuttlefish; live edible insects; live eels; live ferns; live fish for aquariums; live fishing bait; live flower arrangements; live flowers; live game; live gosari [ferns]; live hatching eggs; live hemp

plants; live herrings; live insects; live laboratory animals; live langoustines; live lobsters; live marijuana plants; live mussels; live octopuses; live oysters; live perch; live plaices; live plants; live plants used as aquarium landscapes; live poultry; live prawns; live red snapper; live red snappers; live salmon; live sardines; live sea bass; live sea basses; live sea bream; live sea breams; live sea cucumbers; live sea urchins; live sea-cucumbers; live shellfish; live short-necked clams; live shrimp; live shrimps; live shrimps, prawns, and lobsters; live shrubs; live silver carp; live silver carps; live soft-shelled turtles; live spiny lobsters; live squid; live sweetfish; live swordfish; live topiaries; live trees; live trout; live trouts; live tuna; live tuna fish; live whales; livestock feed; living fruit plants; living plants; locust beans; loose hemp for use as animal bedding; lychees; maize; maize cake for cattle; malt for brewing; malt for brewing and distilling; malt for distilling; mash for fattening livestock; milk replacers for animals; mineral salts for cattle; mixed animal feed; mulch; natural flower arrangements; natural flower garlands; natural flower wreaths; natural flowering plants; natural flowers; natural plants; natural plants and flowers; natural rice for use as animal fodder; natural turf; non-debarked timber; oats; oil cake; organic fresh fruit; organic fresh fruit and vegetables; organic fresh herbs; organic fresh vegetables; packaged freeze-dried fishing bait; palm fronds; palm trees; partly worked palm trees leaves; peanut cake for animals; peanut meal for animals; peat moss; pepper plants; pet beverages; pet food; pet treats in the nature of bully sticks; pig feed; pigs; pine cones; plant bulbs; plant bulbs for agricultural purposes; plant bulbs for horticultural purposes; potted bonsai; potted dwarfed trees; potted fresh herbs; poultry feed; poultry for breeding; preparations for egg laying poultry; protein for animal consumption; puppy biscuits; puppy food; quince; rape cake for cattle; rapeseed meal for animal consumption; raw bark; raw barks; raw cocoa beans; raw grains; raw locust beans; raw sugarcane bagasses; raw timber; residual products of cereals for animal consumption; rice bran for animal consumption; rice meal for forage; rootstocks for fruit tree grafting; rose bushes; roses; rough cork; rye; rye seed; salt for cattle; salt licks; sansho [Japanese pepper] trees; saplings; sassafras; scions for fruit tree grafting; seaweed for human consumption; seedlings; seeds for agricultural purposes; seeds for flowers; seeds for fruit; seeds for fruit and vegetables; seeds for growing apple trees; seeds for growing flowers; seeds for growing fruits; seeds for growing fruits and vegetables; seeds for growing herbs; seeds for growing plants; seeds for growing urushi trees; seeds for growing vegetables; seeds for horticultural purposes; seeds for planting; seeds for sowing; seeds for vegetables; seeds of urushi; sesame; sheep; shrubs; silkworm eggs; silkworms; small animal litter; sod; sorghum; sowing seeds; soy; soy bean meal animal feed; soy bean meal for animal consumption; soy sauce cakes animal feed; soybeans; spawn for agricultural purposes; spirulina for human or animal consumption; spores and spawn for agricultural purposes; spores for agricultural purposes; starch pulp animal feed; starch pulp for animal consumption; starter food for calves; straw for animal bedding; straw litter; straw litter for small animals; straw mulch; strengthening animal forage; sugar cane; sugarcane; sweet corn, unprocessed; synthetic animal feed; trunks of trees; undressed timber; unhusked sweet corn ears; unprocessed agar for human consumption [Tengusa seaweed]; unprocessed algae for animal consumption; unprocessed algae for human consumption; unprocessed aosa seaweed [sea lettuce]; unprocessed brown algae for human consumption [Hijiki seaweed]; unprocessed cereals; unprocessed chia seeds; unprocessed edible flaxseed; unprocessed edible linseed; unprocessed edible sesame; unprocessed grain; unprocessed grains; unprocessed grains for eating; unprocessed hops; unprocessed kelp [Kombu seaweed]; unprocessed mushrooms; unprocessed oats; unprocessed oil seeds; unprocessed proso millet; unprocessed quinoa; unprocessed raw fruit; unprocessed raw vegetables; unprocessed rice; unprocessed sea lettuce for human consumption [Aosa seaweed]; unprocessed seeds for agricultural purposes; unprocessed sugar beets; unprocessed sweet corn; unprocessed teff; unprocessed tengusa seaweed; unprocessed timber; unprocessed wakame seaweed; urushi tree seeds; vegetable seeds; wheat; wheat bran; wheat germ for animal consumption; wheat

seeds; wild hops; wood chips for the manufacture of wood pulp; wood chips for use as ground cover; wood shavings for animal bedding; wood shavings for use as animal bedding; wood shavings for use as animal litter; wreaths of dried flowers; wreaths of dried herbs for decoration; wreaths of natural flowers; yeast for animal consumption; yeast for animal fodder; yeast for animals; young fresh soybeans in the pod [eda-mame]

Class 32

(4) aerated fruit juice; aerated mineral waters; aerated water; alcohol free aperitifs; alcohol free wine; alcohol-free beers; alcohol-reduced beer; ale; ale and porter; ales; aloe juice beverages; aloe juice drinks; aloe vera juices; antioxidant juice drinks; apple juice; apple juice beverages; apple juice drinks; beer; beer, ale and lager; beer, ale and porter; beer, ale, lager, stout and porter; beer, ale, lager, stout, porter, shandy; beer wort; beer-based alcopops; beer-based beverages; beer-based cocktails; beers; beet juice; beetroot juice; beverages consisting of a blend of fruit and vegetable juices; bitter lemon; black beer; black beers; blackcurrant cordial; blackcurrant juice; blackcurrant juice cordial; bottled drinking water; bottled water; calcium-enriched fruit juice; carbonated mineral water; carbonated mineral waters; carbonated soft drinks; carbonated water; carbonated waters; carrot juice; coconut water; coconut water beverages; coconut-based beverages; coffee-flavored soft drinks; coffee-flavoured ale; coffee-flavoured beer; coffee-flavoured soft drinks; cola; cola beverages; cola drinks; concentrated fruit juice; concentrated fruit juices; concentrates for making fruit beverages; concentrates for making fruit drinks; concentrates for making fruit juices; concentrates used in the preparation of soft drinks; cranberry juice; cranberry juice beverages; cranberry juice drinks; cream soda; de-alcoholised beer; de-alcoholized beer; de-alcoholized beers; de-alcoholized wines; distilled drinking water; drinking water; drinking water with vitamins; dry ginger ale; effervescent water; energy drinks; essences for making flavoured mineral water; essences for making soft drinks; essences for the preparation of mineral waters; extracts of hops for making beer; extracts of unfermented must; flat water; flavoured beers; flavoured mineral water; flavoured mineral waters; flavoured waters; frozen carbonated beverages; frozen carbonated drinks; frozen fruit beverages; frozen fruit drinks; frozen fruit-based beverages; frozen fruit-based drinks; fruit beverages; fruit beverages and fruit juices; fruit beverages and juices; fruit concentrates and purées used for making beverages; fruit drinks and fruit juices; fruit drinks and juices; fruit flavoured carbonated drinks; fruit flavoured drinks; fruit flavoured soft drinks; fruit juice; fruit juice bases; fruit juice concentrates; fruit juices; fruit nectars; fruit smoothies; fruit squashes; fruit-based beverages; fruit-based drinks; fruit-based soft drinks flavored with tea; fruit-based soft drinks flavoured with tea; fruit-flavored beverages; fruit-flavoured beverages; fruit-flavoured beverages; fruit-flavoured carbonated beverages; fruit-flavoured carbonated drinks; fruit-flavoured drinks; fruit-flavoured soft drinks; ginger ale; ginger beer; glacial water; grape juice; grape juice beverages; grapefruit juice; guarana beverages; guava juice; hop extracts for making beer; hop extracts for manufacturing beer; ice tea powder mix; iced fruit beverages; iced fruit drinks; imitation beer; isotonic beverages; isotonic drinks; lager; lagers; lemon juice; lemon juice for use in the preparation of beverages; lemon squash; lemonade; lemonades; light beer; lime cordial; lime juice cordial; lime juice for use in the preparation of beverages; lithia water; low calorie soft drinks; low-alcohol beer; malt beer; malt extracts for making beer; malt extracts for making liquors; malt syrup for beverages; malt syrups for beverages; malt wort; mango juice; meal replacement drinks; mineral and aerated waters; mineral and carbonated waters; mineral enhanced water; mineral water; mixed fruit juice; mixed fruit juices; mixes for making sherbet beverages; mixes for making sorbet beverages; must; non-alcoholic aperitifs; non-alcoholic beer; non-alcoholic beer flavored beverages; non-alcoholic beer-flavored beverages; non-alcoholic beer-flavoured beverages; non-alcoholic beverages containing fruit juices; non-alcoholic beverages containing vegetable juices; non-alcoholic beverages flavored with coffee; non-alcoholic beverages

flavored with tea; non-alcoholic beverages flavoured with coffee; non-alcoholic beverages flavoured with tea; non-alcoholic beverages with tea flavor; non-alcoholic carbonated beverages; non-alcoholic carbonated drinks; non-alcoholic cider; non-alcoholic cinnamon punch with dried persimmon [sujeonggwa]; non-alcoholic cocktail mixes; non-alcoholic cocktails; non-alcoholic cordials; non-alcoholic fruit cocktails; non-alcoholic fruit drinks; non-alcoholic fruit extracts; non-alcoholic fruit extracts used in the preparation of beverages; non-alcoholic fruit juice beverages; non-alcoholic fruit juice drinks; non-alcoholic fruit nectars; non-alcoholic fruit punch; non-alcoholic grape juice beverages; non-alcoholic honey-based beverages; non-alcoholic honey-based drinks; non-alcoholic kvass; non-alcoholic punch; non-alcoholic rice punch [sikhye]; non-alcoholic sparkling fruit juice beverages; non-alcoholic sparkling fruit juice drinks; non-alcoholic vegetable juice beverages; non-alcoholic vegetable juice drinks; non-alcoholic wine; non-dairy soy beverages; orange juice; orange juice beverages; orange juice drinks; orange squash; orgeat; pale ale; pale ales; papaya juice; passion fruit juice; peach juice; pilsner; pineapple juice; pineapple juice beverages; pineapple juice drinks; pomegranate juice; porter; powder used in the preparation of fruit juices; powder used in the preparation of soft drinks; powders for effervescing beverages; powders used in the preparation of coconut water beverages; powders used in the preparation of coconut water drinks; powders used in the preparation of fruit-based beverages; powders used in the preparation of fruit-based drinks; powders used in the preparation of soft drinks; preparations for making aerated water; preparations for making beer; preparations for making mineral water; protein-enriched sports beverages; protein-enriched sports drinks; quinine water; ramune [Japanese carbonated soft drinks]; ramune [Japanese soda pop]; reduced-alcohol beer; root beer; seltzer water; shandy; sherbet beverages; sikhye [non-alcoholic rice punch]; smoked plum juice beverages; smoked plum juice drinks; smoothies; soda pop; soda pops; soda water; soft drink concentrates; soft drinks; soft drinks flavoured with tea; sparkling mineral water; sparkling water; sports drinks; sports drinks containing electrolytes; spring water; still water; stout; sujeonggwa [non-alcoholic cinnamon punch with dried persimmon]; sweet cider; syrups for beverages; syrups for lemonade; syrups for making beverages; syrups for making flavored mineral waters; syrups for making flavoured mineral waters; syrups for making fruit-flavored drinks; syrups for making fruit-flavored soft drinks; syrups for making fruit-flavoured drinks; syrups for making lemonade; syrups for making non-alcoholic beverages; syrups for making non-alcoholic drinks; syrups for making soft drinks; syrups for making whey-based beverages; syrups for the preparation of fruit juices; syrups for the preparation of soft drinks; syrups used in the preparation of soft drinks; table waters; toasted-malt beer; tomato juice; tomato juice beverages; tonic water; unfermented grape must; unfermented preserved must; vegetable juice beverages; vegetable juices; vegetable smoothies; vegetable-based beverages; vegetable-based drinks; vitamin enhanced water; vitamin enriched fruit juice; wheat beer; wheat beers; winemaking must

Application Number 1,946,836
Language of Application English

Filing Date 2019-02-19

APPLICANT AND AGENT DETAILS

Applicant

GP CLUB CO., LTD
1222-12F Changgang Bd, 86, Mapo-daero
Mapo-gu
REPUBLIC OF KOREA

Agent

DJB
500 Boulevard Gouin E, Suite 302, Montréal,
QUEBEC, H3L3R9

TRADEMARK DETAILS

GANGBLY

Trademark Type

Word

Goods

Class 03

Cosmetics; cosmetic preparations for skin care; cosmetic creams; lotions for cosmetic purposes; beauty masks, soap, namely bath soap, cosmetic soaps; body and beauty care cosmetics; hair lotions, cleaners, namely facial cleaners, and peels, namely chemical peels for skin.

Application Number 1,947,414
Language of Application English

Filing Date 2019-02-21

APPLICANT AND AGENT DETAILS

Applicant

Michael Hill Franchise Pty Ltd
7 Smallwood Place
Murarrie QLD 4172
AUSTRALIA

Agent

GOWLING WLG (CANADA) LLP
SUITE 1600, 1 FIRST CANADIAN PLACE, 100
KING STREET WEST, TORONTO, ONTARIO,
M5X1G5

TRADEMARK DETAILS

PRELUDE

Trademark Type

Word

Goods

Class 14

Jewellery, namely rings, necklaces, pendants, earrings, charms, chains, bracelets, brooches and bangles, beads for making jewellery, custom jewellery, precious stones namely diamonds, opals, pearls and coloured stones, jewellery in precious metals and their alloys namely jewellery of gold, silver and platinum, jewellery in precious metals and coated therewith, chronological, horological and chronometric instruments namely watches and clocks, alarm watches, divers' watches, electric watches, electronic watches, jewellery watches, mechanical watches with automatic winding, mechanical watches with manual winding, wrist watches, pendant watches, pocket watches, sports watches, watches made of gold, watches made of precious metals, watch bracelets, bracelets and watches combined, metal expanding watch bracelets, watches incorporating a memory function, straps for watches and bands for watches namely leather watch straps, metal watch bands, non-leather watch straps, faces for watches namely dials for watches and hands for watches, jewellery containing crystal or glass, jewellery cases and caskets of precious metals, jewellery cases and caskets, parts for each of the foregoing

Services

Class 35

Retail and wholesale of jewellery, precious metal and their alloys, jewellery in precious metals or coated therewith, precious and semi-precious stones, jewellery cases, jewellery caskets, perfume, perfume bottles, charms, bracelets, necklaces, chains, rings, trinkets, jewellery of shell, amber and mother-of-pearl, horological and chronometric instruments namely watches and clocks, and parts and accessories for each of the foregoing, business information services in the field of jewellery, organisation, operation, management, and supervision of customer loyalty programmes, promoting the sale of goods and services through a customer loyalty program, computer database management, invoicing services, information, advisory and consultancy services in relation to the aforementioned services, and provision of all of the aforementioned services electronically, namely via the Internet

Claims

Priority Filing Date: February 18, 2019, Country or Office: AUSTRALIA, Application No: 1990108 in association with the same kind of goods and in association with the same kind of services

Application Number 1,947,465
Language of Application English

Filing Date 2019-02-21

APPLICANT AND AGENT DETAILS

Applicant

CPK Management Company
12181 Bluff Creek Drive, 5th Floor
Playa Vista, CA 90094
UNITED STATES OF AMERICA

Agent

OSLER, HOSKIN & HARCOURT LLP
SUITE 1900, 340 ALBERT STREET,
OTTAWA, ONTARIO, K1R7Y6

TRADEMARK DETAILS

CALIFORNIA PIZZA KITCHEN

Trademark Type

Word

Goods

Class 29

(1) Meat; shellfish, not live; poultry; calamari, not live; processed vegetables, namely mixed vegetables, vegetable puree, vegetable soup preparation; vegetable salads; salads of meat, poultry, chicken and shrimp; pre-cut lettuce wraps with chicken and shrimp; soups; hummus; snack dips; processed tomato checca; guacamole; coleslaw; and milk for consumption on and off the premises.

Class 30

(2) Pizza; pastas; pita bread; pizza bread; bread; foccacia bread; sandwiches; desserts, namely, cakes, pies, pastry; apple crisp; tiramisu; brownies; salad dressings; dipping sauces, namely dairy-based dipping sauces, meat-based dipping sauces, fruit-based dipping sauces, vegetable-based dipping sauces; dumplings; tortilla spring rolls; shrimp rolls; tortilla chips; ice creams; ice cream sundaes; coffee; espresso; cappuccino; iced cappuccino; cafe mocha; cafe au lait; cafe latte; hot chocolate; tea; and iced tea, for consumption on and off the premises; frozen pizza.

(3) Frozen pizza.

Services

Class 43

(1) Restaurant services.

(2) Dine-in restaurant services; carry-out restaurant services; beverage services, namely, preparation and serving of beverages; catering services; and restaurants featuring home and office delivery services.

Application Number 1,947,466
Language of Application English

Filing Date 2019-02-21

APPLICANT AND AGENT DETAILS

Applicant

CPK Management Company
12181 Bluff Creek Drive, 5th Floor
Playa Vista, CA 90094
UNITED STATES OF AMERICA

Agent

OSLER, HOSKIN & HARCOURT LLP
SUITE 1900, 340 ALBERT STREET,
OTTAWA, ONTARIO, K1R7Y6

TRADEMARK DETAILS

Trademark Type

Design

Visual Representation



Colour Claim

Colour is claimed as a feature of the trade-mark. The palm tree is black on a yellow diamond shaped background. The words CALIFORNIA PIZZA KITCHEN are black.

Goods

Class 29

(1) Meat; shellfish, not live; poultry; calamari, not live; processed vegetables, namely mixed vegetables, vegetable puree, vegetable soup preparation; vegetable salads; salads of meat, poultry, chicken and shrimp; pre-cut lettuce wraps with chicken and shrimp; soups; hummus; snack dips; processed tomato checca; guacamole; coleslaw; and milk for consumption on and off the premises.

Class 30

(2) Pizza; pastas; pita bread; pizza bread; bread; foccacia bread; sandwiches; desserts, namely, cakes, pies, pastry; apple crisp; tiramisu; brownies; salad dressings; dipping sauces, namely dairy-based dipping sauces, meat-based dipping sauces, fruit-based dipping sauces, vegetable-based dipping sauces; dumplings; tortilla spring rolls; shrimp rolls; tortilla chips; ice creams; ice cream sundaes; coffee; espresso; cappuccino; iced cappuccino; cafe mocha; cafe au lait; cafe latte; hot chocolate; tea; and iced tea, for consumption on and off the premises; frozen pizza.

Services

Class 43

Dine-in restaurant services; carry-out restaurant services; beverage services, namely, preparation and serving of beverages; catering services; and restaurants featuring home and office delivery services.

Application Number 1,947,752
Language of Application English

Filing Date 2019-02-22

APPLICANT AND AGENT DETAILS

Applicant

MAGIC BOX INT. TOYS, S.L.U
Pl. Xavier Cugat 2, Edifici D, Pl. 2 A
08174 - SANT CUGAT DEL VALLÈS
(Barcelona)
SPAIN

Agent

ROBIC
630, boul. René-Lévesque Ouest, 20e étage,
Montréal, QUEBEC, H3B1S6

TRADEMARK DETAILS

SUPERZINGS RIVALS OF KABOOM

Trademark Type

Word

Goods

Class 28

Games, namely, toy figures; Board games; Game boards for trading card games; Video game machines; Toys, namely, children's multiple activity toy; Children's playthings, namely, infant toys; Mechanical action toys; Plush toys; Dolls.

Application Number 1,947,775
Language of Application English

Filing Date 2019-02-22

APPLICANT AND AGENT DETAILS

Applicant

Kaloom Inc.
355 Peel Street
Suite 403
Montreal
QUEBEC
H3C2G9

Agent

BERESKIN & PARR LLP/S.E.N.C.R.L., S.R.L.
SCOTIA PLAZA, 40 KING STREET WEST,
40th FLOOR, TORONTO, ONTARIO, M5H3Y2

TRADEMARK DETAILS

CLOUD EDGE FABRIC

Trademark Type

Word

Goods

Class 09

Computer software for use in the field of data centers, namely, software for the management and operation of a computer network

Services

Class 42

Computer software consultancy; Installation, maintenance, and updating of computer software

Application Number 1,948,090
Language of Application English

Filing Date 2019-02-25

APPLICANT AND AGENT DETAILS

Applicant

Henkel Corporation
One Henkel Way
Rocky Hill, CT 06067
UNITED STATES OF AMERICA

Agent

NORTON ROSE FULBRIGHT CANADA LLP/S.
E.N.C.R.L.,S.R.L.
1, Place Ville Marie, Suite 2500, Montreal,
QUEBEC, H3B1R1

TRADEMARK DETAILS

FLEX INSTA HOLD

Trademark Type

Word

Goods

Class 03

hair styling preparations;

Application Number 1,948,091
Language of Application English

Filing Date 2019-02-25

APPLICANT AND AGENT DETAILS

Applicant

Henkel Corporation
One Henkel Way
Rocky Hill, CT 06067
UNITED STATES OF AMERICA

Agent

NORTON ROSE FULBRIGHT CANADA LLP/S.
E.N.C.R.L.,S.R.L.
1, Place Ville Marie, Suite 2500, Montreal,
QUEBEC, H3B1R1

TRADEMARK DETAILS

HIGH INSTA HOLD

Trademark Type

Word

Goods

Class 03

hair styling preparations;

Application Number 1,948,194
Language of Application English

Filing Date 2019-02-26

APPLICANT DETAILS

Applicant

Michael Krokis
8322 99th ave
Fort Saskatchewan
ALBERTA
T8L3C5

TRADEMARK DETAILS

Trademark Type

Design

Visual Representation



kannasafe

secure your stash

Goods

Class 16

(1) advertising pamphlets; cardboard packaging boxes in collapsible form

Class 18

(2) all-purpose carrying bags; bags made of leather; leather and imitation leather bags; leather cases

Class 20

(3) boxes of wood and plastic; wooden boxes

Class 21

(4) glass jars; jars

Class 25

(5) athletic apparel

Class 34

(6) cannabis grinders; cigar boxes; cigarette boxes; marijuana grinders; tobacco jars

Application Number 1,948,291
Language of Application English

Filing Date 2019-02-26

APPLICANT AND AGENT DETAILS

Applicant

Eli Lilly and Company
Lilly Corporate Center
Indianapolis, IN 46285
UNITED STATES OF AMERICA

Agent

BORDEN LADNER GERVAIS LLP
World Exchange Plaza, 100 Queen Street,
Suite 1300, Ottawa, ONTARIO, K1P1J9

TRADEMARK DETAILS

TEMPO SMART BUTTON

Trademark Type

Standard Characters

Goods

Class 10

Wireless dose detection modules attachable to insulin pens for the transmission of information on insulin delivery, timing, glucose information and glucose levels.

Claims

Priority Filing Date: December 11, 2018, Country or Office: UNITED STATES OF AMERICA,
Application No: 88224775 in association with the same kind of goods

Application Number 1,948,347
Language of Application English

Filing Date 2019-02-26

APPLICANT AND AGENT DETAILS

Applicant

Refractory Intellectual Property GmbH & Co.
KG
Wienerbergstrasse 11
1100 Wien
AUSTRIA

Agent

KIRBY EADES GALE BAKER
100 Murray Street, Suite 500, Ottawa,
ONTARIO, K1N0A1

TRADEMARK DETAILS

JEBCO

Trademark Type

Word

Goods

Class 17

(1) Seals, namely, dynamic seals; seals, namely, sealing compounds for masonry; fillers, namely, fillers for expansion joints; caulking materials, namely, caulking compounds; insulation materials, namely, ceramic enamel fiber insulation and thermal insulation; refractory insulating materials.

Class 19

(2) building and construction materials, not of metal, namely, ceramic bricks, ceramic tiles, ceramic plates, ceramic mats, ceramic slabs, ceramic webs, ceramic panels, ceramic boards, ceramic posts, ceramic blocks, ceramic tubes, ceramic rods, ceramic fibers, and ceramic foils; refractory building and construction materials, not of metal, namely, ceramic bricks, ceramic shapes, ceramic tiles, ceramic plates, ceramic mats, ceramic slabs, ceramic webs, ceramic panels, ceramic boards, ceramic posts, ceramic blocks, ceramic tubes, ceramic rods, ceramic fibers, ceramic foils, ceramic plugs, ceramic bricks, ceramic tubes, ceramic nozzles, ceramic well blocks, ceramic plates, ceramic tuyers, ceramic gas purging plugs, ceramic tapping spouts, ceramic lances and ceramic runners, all the aforesaid goods being not of metal and refractory; refractory ceramic masses, namely, refractory casting compounds, not of metal, and refractory concrete; refractory ceramic masses, namely, refractory dolomite casting, gunning, repair and ramming compounds, not of metal; refractory workpieces of ceramic, namely, ceramic refractory blocks, not of metal, and refractory ceramic tiles; refractory ceramic mixtures, namely, refractory castable mixes, refractory vibratable mixes of ceramics, refractory ramming mixes of ceramic, refractory gunning mixes of ceramic and refractory dry-setting mixes of ceramic; refractory mortar (not of metal); refractory oven fittings (not of metal), namely, refractory furnace linings; silos, not of metal, namely, cement silos, concrete silos, silos for ceramic refractory raw materials and silos for ceramic refractory castable mixes

Claims

Priority Filing Date: October 02, 2018, Country or Office: EUIPO (EU), Application No: 017963872 in association with the same kind of goods

Application Number 1,949,741
Language of Application English

Filing Date 2019-03-06

APPLICANT AND AGENT DETAILS

Applicant

Heritage Insurance, Ltd.
A-100 Fairford St W
Moose Jaw
SASKATCHEWAN
S6H1V3

Agent

FURMAN IP LAW & STRATEGY PC
300 - 1914 HAMILTON STREET, REGINA,
SASKATCHEWAN, S4P3N6

TRADEMARK DETAILS

Trademark Type

Design

Visual Representation



Disclaimer

The right to the exclusive use of the 11-point maple leaf is disclaimed apart from the trademark.

Services

Class 36

insurance agencies; insurance brokerage

Application Number 1,949,923
Language of Application English

Filing Date 2019-03-06

APPLICANT DETAILS

Applicant
CHOIRSUN TECHNOLOGY INC.
1818 Hampton Green
Coquitlam
BRITISH COLUMBIA
V3E3G2

TRADEMARK DETAILS

Trademark Type
Design

Visual Representation



Goods

Class 09

(1) barcode readers; bar-code scanners; bicycle flashing safety lights; bicycle helmets; bicycle speedometers; carrying cases for mobile telephones; cases adapted for mobile phones; cases for smartphones; computer e-commerce software to allow users to perform electronic business transactions via a global computer network; computer fingerprint imaging software; computer fingerprint scanning software; computer games; computer games downloadable from a global computer network; computer games for use on mobile and cellular phones; computer mouse pads; computer programs and computer software for electronic trading of securities; computer programs and software for image processing; computer programs for processing digital music files; computer programs for searching remotely for content on computers and computer networks; computer programs for using the Internet and the World Wide Web; computer software for computer-aided design/computer-aided manufacturing [CAD/CAM]; computer software for creating and editing music and sounds; computer software for fingerprint imaging; computer software for fingerprint scanning; computer software for global positioning systems; computer software for image processing; computer software for logistics, namely, software for tracking documents, packages

and freight; computer software for managing retail store customer accounts; computer software for organizing and viewing digital images and photographs; computer software for processing digital images; computer software for processing digital music files; computer software for the creation of firewalls; computer software for use in creating and designing web sites; computer software for use in generating streaming advertisements on the web sites of others; computer software for use in managing and controlling production schedules, shipping schedules, purchase of materials, inventories and accounts; computer video games; computer video games downloaded via the internet; covers for mobile telephones; covers for smartphones; digital music downloadable from internet; digital music downloadable from the Internet; display screen filters adapted for use with computer monitors; display screen filters adapted for use with tablet computers; display screen filters adapted for use with televisions; distance sensors; downloadable application for mobile phones to download video games via the internet; downloadable applications for handheld computers to download music, movie and television graphics; downloadable applications for handheld computers to download video games; downloadable applications for mobile phones to enable the streaming of music; downloadable applications for mobiles phones to download music, movie and television graphics; downloadable applications for mobiles phones to download video games; downloadable applications for tablet computers to download music, movie and television graphics; downloadable applications for tablet computers to download video games; downloadable applications for tablet computers to enable the streaming of movies and television shows; downloadable applications for tablet computers to enable the streaming of music; downloadable computer games; downloadable electronic games; downloadable electronic games for use with mobile telephones, handheld computers and tablet computers; downloadable multimedia news podcasts; downloadable multimedia news webcasts; downloadable multimedia news weblogs; downloadable music for mobile telephones, handheld computers and tablet computers; downloadable templates for designing audiovisual presentations; downloadable video games; downloadable video recordings featuring music; earphones and headphones; educational software for children; electric and electronic effects units for musical instruments; electric and electronic musical effects equipment; electric batteries for vehicles; electronic labels; infrared sensors; interactive multimedia computer games; interactive touch screen terminals; motorcycle helmets; mouse mats; personal digital assistants [PDAs]; projectors for the entertainment industry; protective cases for mobile phones; protective cases for smartphones; solar batteries; Solar cells; solar panels for the production of electricity; solar wafers; speedometers

Class 12

(2) air pumps for automobiles; air pumps for two-wheeled motor vehicles and bicycles; airbags for vehicles; bicycle frames; bicycle motors; bicycle parts; bicycle pedals; bicycle pumps; bicycle rims; bicycle saddles; bicycle seats; bicycle wheel hubs; bicycle wheel rims; bicycles; camera drones; civilian drones; electric bicycles; electric cars; electric scooters; electrical anti-theft installations for vehicles; electrically powered aircraft; electrically powered motor vehicles; frames for bicycles; front forks for bicycles; front forks for motorcycles; handle bars for bicycles; handle bars for motorcycles; hubs for bicycle wheels; hubs for motorcycle wheels; motorcycle handlebars; motorcycle saddles; motorcycles; robotic cars; saddle covers for bicycles; saddle covers for motorcycles; saddles for bicycles; saddles for motorcycles; space vehicles; tricycles;

Class 28

(3) action skill games; computer game consoles; electronic hand-held game units; electronic hand-held games; hand-held consoles for playing video games; hand-held electronic game units adapted for use with an external display screen or monitor; hand-held electronic video games; hand-held game consoles; hand-held units for playing electronic games; joypads for use with electronic games; joypads for video games; video game interactive control floor pads or mats

Services**Class 35**

(1) advertising by transmission of on-line publicity for third parties through electronic communications networks; advertising flyer distribution; advertising flyer distribution for others; advertising on the Internet for others; advertising text publication services for others; advertising the goods and services of others; advertising the goods and services of others in periodicals, brochures and newspapers; advertising the goods and services of others through all public communication means; advertising the goods and services of others via electronic media and specifically the internet; advice and information about customer services and product management and prices on Internet sites in connection with purchases made over the Internet; advice and information concerning commercial business management; advice in the field of business management and marketing; business consulting in the field of business acquisitions and mergers; business consulting in the field of business networking; business efficiency expert services; business efficiency services; business intermediary services relating to the matching of potential private investors with entrepreneurs needing funding; business management advice; business management consultancy via the Internet; business management consulting with relation to strategy, marketing, production, personnel and retail sale matters; business management in the field of transport and delivery; creating and updating advertising material for others; creation of trade-marks for others; distribution of advertisements and commercial announcements for others; distribution of advertising mail and of advertising supplements attached to regular editions for others; distribution of advertising materials for others; electronic billboard advertising of the goods and services of others; foreign trade information and consultation; foreign trade information and consultation services; goods import-export agencies; import-export agencies; on-line advertising for others on computer networks; on-line advertising the goods and services of others on computer communications networks; on-line auction bidding for others; on-line trading services in which seller posts products to be auctioned and bidding is done via the Internet; online advertising for others via a computer communications network; production of advertising films for others; production of advertising materials for others; production of advertising matter and commercials for others; promoting the goods and services of others by preparing and placing advertisements in electronic magazines; promoting the goods and services of others through advertisements on Internet websites; promoting the goods and services of others through infomercials; promoting the music of others by means of providing online portfolios via a website; providing a searchable online advertising guide featuring the goods and services of other on-line vendors on the internet; providing an on-line commercial information directory on the internet; providing an online commercial information directory on the Internet; providing and rental of advertising space on the internet; providing and rental of exhibition stands and booths; providing business information in the field of social media; providing business marketing information for others; providing electronic verification of online orders of digital content; providing information in the area of global sustainable business solutions; providing on-line auction services; providing online auction services; providing online commercial directory information services; provision of market research information; provision of space on websites for advertising goods and services; selling domain names; services for provision of foreign trade information; wholesale sales of auto parts; wholesale sales of clothing; wholesale sales of cosmetics; wholesale sales of home entertainment electronics; wholesale sales of sporting goods;

Class 41

(2) entertainment in the form of dance performances; entertainment in the form of laser shows; entertainment in the form of live musical concerts; entertainment in the form of live performances

by a musical band; entertainment services in the nature of live musical plays; entertainment services in the nature of live performances by a musical band; film and video production; film distribution; film production; lighting production services; online video gaming services; organizing fitness equipment shows; organizing music competitions; performances featuring live dance and live music; production of laser light shows; production of live musical variety shows; production of musical videos; production of news webcasts; production of video games; providing information in the field of early childhood education via an interactive website; providing information in the field of exercise via an interactive website; providing information in the field of music via an online blog; providing information in the field of musical entertainment for children via a website; providing on-line computer games; providing ratings for television, movie, music, video and video game content; publication of books and magazines; publication of books, magazines and newspapers on the Internet; publication of brochures; publication of calendars; publication of catalogs; publication of electronic books and magazines on-line; publication of electronic books and magazines online; publication of electronic books and periodicals online; publication of electronic magazines; publication of electronic periodicals online; publication of magazines; publication of periodicals; publishing of electronic magazines; publishing of web magazines; video editing; video film production; video production;

Class 42

(3) cloud computing provider services for general storage of data; cloud computing providing software for database management; cloud computing video hosting web sites; computer aided imaging; computer animation production services; computer graphics digitization; computer programming of computer games; computer programming of video games; computer programming services for commercial analysis and reporting; computer software design and updating; computer software design for others; computer website design; consultancy in the field of webpage design; consultation services relating to computer software; creating and designing web pages for others; creating and maintaining blogs for others; creating and maintaining web sites for others; creating and maintaining weblogs for others; creating home pages for others; creating of home pages for computer networks for others; creating web pages for others; creation and maintenance of web sites for others; creation and provision of web pages to and for third parties; creation of internet web sites for others; creation, design, development and maintenance of web sites for third parties; design and creating web sites for others; design and development of computer game software; design and development of computer game software and virtual reality software; design and development of computer hardware and software; design and development of computer hardware for the manufacturing industries; design and development of computer software; design and development of computer software for supply chain logistics; design and development of virtual reality software; design and development of wireless computer networks; design and maintenance of web sites for others; design of homepages and websites; design, creation, hosting and maintenance of internet sites for third parties; design, creation, hosting, maintenance of websites for others; design, development and implementation of software; design, development, installation and maintenance of computer software; design, installation, updating and maintenance of computer software; design, maintenance, development and updating of computer software; design, updating and rental of computer software; design, upgrading and rental of computer software; designing and developing webpages on the internet for others; designing of packaging and wrapping materials; designing websites for the advertising purposes of others; development of computer hardware for computer games; development of computer programs recorded on software designed for use in construction and automated manufacturing (cad/cam); development, design and updating of home pages; electronic storage of photographic images; graphic design of promotional materials; homepage and webpage design; hosting internet sites for others; hosting

on-line web facilities for others; hosting websites on the internet; installation, maintenance and repair of computer software; installation, repair and maintenance of computer software; maintenance and updating of computer software; maintenance and upgrading of computer software; maintenance of software for Internet access; packaging design; platform as a service (PAAS) featuring computer software platforms for use in the field of financial services for trading derivatives; product packaging design services; providing search engines for the internet; software as a service (SaaS) provider in the field of providing customer relations management; software as a service (SAAS) provider in the field of software for small business accounting; software design and development;

Application Number 1,952,299
Language of Application English

Filing Date 2019-03-19

APPLICANT AND AGENT DETAILS

Applicant

DJO, LLC
5919 Sea Otter Place
Suite 200
Carlsbad, California 92010
UNITED STATES OF AMERICA

Agent

KATE HENDERSON
128 Vine Avenue, Toronto, ONTARIO, M6P1V7

TRADEMARK DETAILS

Trademark Type

Design

Visual Representation

ICEMAN CLASSIC³

Authorisation For Use

Consent from CALGARY OLYMPIC DEVELOPMENT ASSOCIATION is of record.

Goods

Class 10

Therapeutic medical device, namely, water circulation cold therapy unit

Claims

Priority Filing Date: September 21, 2018, Country or Office: UNITED STATES OF AMERICA,
Application No: 88/127,856 in association with the same kind of goods

Application Number 1,952,637
Language of Application English

Filing Date 2019-03-20

APPLICANT DETAILS

Applicant

FOLAJIMI VINCENT AKINSETE
1-3470 Laird Rd
Mississauga
ONTARIO
L5L5Y4

TRADEMARK DETAILS

Trademark Type

Design

Visual Representation



Goods

Class 09

(1) clinical centrifuges

Class 10

(2) beds specially made for medical purposes; medical and surgical knives and cutters for cutting human or animal tissue and organs; medical instruments for general examination; pulse oximeters for medical purposes

Class 11

(3) electric autoclaves

Class 21

(4) non-electric autoclaves

Services

Class 44

medical treatment services provided by clinics and hospitals

Application Number 1,952,942
Language of Application English

Filing Date 2019-03-21

APPLICANT AND AGENT DETAILS

Applicant

Heritage Insurance, Ltd.
A-100 Fairford St W
Moose Jaw
SASKATCHEWAN
S6H1V3

Agent

FURMAN IP LAW & STRATEGY PC
300 - 1914 HAMILTON STREET, REGINA,
SASKATCHEWAN, S4P3N6

TRADEMARK DETAILS

NO HASSLE INSURANCE LTD.

Trademark Type

Word

Services

Class 36

insurance agencies; insurance brokerage

Application Number 1,953,334
Language of Application English

Filing Date 2019-03-25

APPLICANT AND AGENT DETAILS

Applicant

Intervet International B.V.
Wim de Körverstraat 35
5831 AN Boxmeer
NETHERLANDS

Agent

GOWLING WLG (CANADA) LLP
SUITE 1600, 1 FIRST CANADIAN PLACE, 100
KING STREET WEST, TORONTO, ONTARIO,
M5X1G5

TRADEMARK DETAILS

UNIVERSAL WORLDSCAN

Trademark Type

Word

Goods

Class 09

Microchip reader device and multi-frequency microchip reader device, both to be used by veterinarians to determine ownership of recovered pets

Application Number 1,953,877
Language of Application English

Filing Date 2019-03-27

APPLICANT DETAILS

Applicant

Buckland Customs Brokers Limited
73 Gaylord Rd
St Thomas
ONTARIO
N5P3R9

TRADEMARK DETAILS

Trademark Type

Design

Visual Representation



Colour Claim

Colour is claimed as a feature of the trademark. The word Buckland is navy blue and the stylized globe is aqua

Services

Class 36

(1) customs brokerage

Class 39

(2) freight forwarding services; warehousing

Application Number 1,953,913
Language of Application English

Filing Date 2019-03-27

APPLICANT AND AGENT DETAILS

Applicant

Michael Hill Franchise Pty Ltd
7 Smallwood Place
Murarrie QLD 4172
AUSTRALIA

Agent

GOWLING WLG (CANADA) LLP
SUITE 1600, 1 FIRST CANADIAN PLACE, 100
KING STREET WEST, TORONTO, ONTARIO,
M5X1G5

TRADEMARK DETAILS

Trademark Type

Design

Visual Representation



Goods

Class 14

Jewellery, namely rings, necklaces, pendants, earrings, charms, chains, bracelets, brooches and bangles, beads for making jewellery, custom jewellery, precious stones namely diamonds, opals, pearls and coloured stones, jewellery in precious metals and their alloys namely jewellery of gold, silver and platinum, jewellery in precious metals and coated therewith, chronological, horological and chronometric instruments namely watches and clocks, alarm watches, divers' watches, electric watches, electronic watches, jewellery watches, mechanical watches with automatic winding, mechanical watches with manual winding, wrist watches, pendant watches, pocket watches, sports watches, watches made of gold, watches made of precious metals, watch bracelets, bracelets and watches combined, metal expanding watch bracelets, watches incorporating a memory function, straps for watches and bands for watches namely leather watch straps, metal watch bands, non-leather watch straps, faces for watches namely dials for watches and hands for watches, jewellery containing crystal or glass, jewellery cases and caskets of precious metals, jewellery cases and caskets, parts for each of the foregoing

Services

Class 35

Retail and wholesale of jewellery, precious metal and their alloys, jewellery in precious metals or coated therewith, precious and semi-precious stones, jewellery cases, jewellery caskets, perfume, perfume bottles, charms, bracelets, necklaces, chains, rings, trinkets, jewellery of shell, amber and mother-of-pearl, horological and chronometric instruments namely watches and clocks, and parts and accessories for each of the foregoing, business information services in the field of jewellery, organisation, operation, management, and supervision of customer loyalty programmes, promoting the sale of goods and services through a customer loyalty program, computer database management, invoicing services, information, advisory and consultancy services in relation to the aforementioned services, and provision of all of the aforementioned services electronically, namely via the Internet

Claims

Priority Filing Date: March 25, 2019, Country or Office: AUSTRALIA, Application No: 1998238 in association with the same kind of goods and in association with the same kind of services

Application Number 1,954,185
Language of Application French

Filing Date 2019-03-28

APPLICANT AND AGENT DETAILS

Applicant

Chocolat Lamontagne inc.
4045 Garlock street
Sherbrooke
QUÉBEC
J1L1W9

Agent

BROUILLETTE LEGAL INC.
1050, Côte du Beaver Hall, Bureau 1500,
MONTREAL, QUÉBEC, H2Z0A5

TRADEMARK DETAILS

QUEEN T

Trademark Type

Word

Goods

Class 29

(1) Fruits séchés, grignotines à base de fruits et amandes confites.

Class 30

(2) Confiseries aux amandes, confiseries à base de fruits, confiseries au chocolat et confiseries au sucre.

Application Number 1,954,588
Language of Application English

Filing Date 2019-04-01

APPLICANT AND AGENT DETAILS

Applicant

OBOTICS INC.
2438 Gramil Crescent
PO Box 286
North Gower
ONTARIO
K0A2T0

Agent

GOWLING WLG (CANADA) LLP
SUITE 2600, 160 ELGIN STREET, OTTAWA,
ONTARIO, K1P1C3

TRADEMARK DETAILS

FLUIDIC

Trademark Type

Standard Characters

Goods

Class 09

(1) Computer software for programming and controlling the operation of adult sexual stimulation aid devices; downloadable software for programming and controlling the operation of adult sexual stimulation aid devices and massage apparatus in the nature of vibrators massagers.

Class 10

(2) Massage apparatus, namely, vibromassage apparatus, namely, vibrators, body massagers, foot massagers; body rehabilitation apparatus for medical purposes, namely, mechanical and hydraulic multi cell massage mattress; therapeutic massagers, and massage apparatus worn by user, namely, a massage band with adjustable straps worn on the arm, leg, or foot; adult sexual stimulation aids, namely, massagers, vibrators, stimulators, dual stimulators, multiple stimulators, and accessories therefor, namely, harnesses straps, personal lubricants, battery chargers, battery charger stands, storage cases, remote controls, personal lubricant dispensers, penis rings, handcuffs, straps, blindfolds; sex toys

Services

Class 35

Online retail store services in the fields of massage apparatus and adult sexual stimulation aids

Application Number 1,955,699
Language of Application English

Filing Date 2019-04-05

APPLICANT AND AGENT DETAILS

Applicant

Percheron Plastic Inc.
789 O'Brien Dr
Peterborough
ONTARIO
K9J6X7

Agent

EMMET CONNOLLY
(LLF LAWYERS LLP), 332 Alymer Street
North, P.O. Box 1146, Peterborough,
ONTARIO, K9J7H4

TRADEMARK DETAILS

PARAPEUTIC

Trademark Type

Word

Goods

Class 04

candles; oil for use in the manufacture of candles; paraffin wax; scented candles; wax for making candles

Application Number 1,955,953
Language of Application English

Filing Date 2019-04-08

APPLICANT AND AGENT DETAILS

Applicant

Kirin Holdings Kabushiki Kaisha (also trading as Kirin Holdings Company, Limited)
10-2, Nakano 4-Chome,
Nakano-Ku
Tokyo
JAPAN

Agent

MARKS & CLERK
180 Kent Street, Suite 1900, Ottawa,
ONTARIO, K1P0B6

TRADEMARK DETAILS

Trademark Type

Design

Visual Representation



Foreign Character Translation

As provided by the applicant, Kirin is the name of a mythical creature in Japanese.

Goods

Class 05

Milk ferments for regulating the intestinal environment; milk ferments for maintaining immune function; milk ferments for maintaining brain cognitive function; milk ferments for vitality; collyrium; nasal spray preparations for medical purposes; nasal spray preparations; medicated lip creams for treating chapped lips; antibiotic lip creams; vaginal moisturizers; vaginal moisturizers in cream form; vaginal pharmaceutical preparations for the prevention and treatment of infections; vaginal pharmaceutical preparations for the treatment of viral diseases, namely, herpes; pharmaceutical cold preparations; liniments; pharmaceutical preparations and other preparations for destroying vermin, fungicides, herbicide; anti-epileptic pharmaceutical preparations; anti-fibrotic pharmaceutical preparations; antiviral pharmaceutical preparations; pharmaceutical preparations and substances for the treatment of diabetes; pharmaceutical preparations and substances for the treatment of gastrointestinal diseases; pharmaceutical preparations for the treatment of hypertension; pharmaceutical preparations for the treatment of gastrointestinal diseases, cancer, bacterial skin infections; human vaccines; veterinary pharmaceutical preparations for the treatment of vitamin deficiencies, intestinal bacteria; veterinary vaccines; pharmaceutical preparations for the treatment of influenza, colds, physical disorder and fatigue; pharmaceutical preparations for maintaining a balance of skin flora and enhancing skin barrier functions; pharmaceutical preparations for treatment of anemia; pharmaceutical preparations for treatment of leukopenia; pharmaceutical preparations for mobilization of peripheral blood progenitor cell; pharmaceutical preparations for treatment of hyperphosphatemia; pharmaceutical preparations for treatment of hyperparathyroidism; pharmaceutical preparations for treatment of cancer; pharmaceutical

preparations for treatment of leukemia; pharmaceutical preparations for treatment of influenza; pharmaceutical preparations for treatment of HIV; pharmaceutical preparations for treatment of myelodysplastic syndrome; pharmaceutical preparations for treatment of hepatitis virus infection; pharmaceutical preparations for treatment of autoimmune hepatitis; pharmaceutical preparations for conditioning treatment prior to hematopoietic stem cell transplantation; vitamin preparations; amino acid dietary supplements; mineral nutritional supplements; intravenous fluids used for nutrition; hemp-based nutritional supplements; medicinal tonics for general health and well-being; calcium pharmaceutical preparations; pharmaceutical preparations for treatment of hypophosphatemia; pharmaceutical preparations for improving wearing-off phenomenon in Parkinson's disease; reagent paper for medical purposes; first aid kits; first-aid boxes, filled; wrapping wafers for medicine doses; gauze for dressings; empty capsules for pharmaceuticals; eyepatches for medical purposes; ear bandages; menstruation bandages; menstruation tampons; sanitary napkins; sanitary panties; absorbent cotton; adhesive plasters; bandages for dressings; liquid bandages; breast-nursing pads; cotton swabs for medical use; mothproofing paper; lacteal flour for babies; anti-oxidants for use as dietary supplements; dietary food supplements in the nature of ready-to-eat protein bars; dietary supplement drink mixes for general health and wellbeing; dietary supplements consisting of amino acids; dietary supplements consisting of minerals; dietary supplements consisting of vitamins; dietary supplements consisting primarily of iron; dietary supplements for body weight control; dietary supplements for controlling cholesterol; dietary supplements for general health and well-being; dietary supplements consisting of oligosaccharides; dietary supplements consisting of hop extracts for general health and well-being; dietary supplements consisting of matured hop extracts for general health and well-being; dietary supplements consisting of hop extracts for reducing cholesterol; dietary supplements consisting of matured hop extracts for reducing cholesterol; dietary supplements consisting of hop extracts for reducing body fat; dietary supplements consisting of matured hop extracts for reducing body fat; dietary supplements consisting of hop extracts for maintaining cognitive function; and dietary supplements consisting of matured hop extracts for maintaining cognitive function; dietary supplements consisting of lactic acid bacteria; dietary food supplements in the nature of ready-to-eat protein bars in tablet, chewable, powder, capsule, liquid or gel form; dietary supplement drink mixes for general health and wellbeing in tablet, chewable, powder, capsule, liquid or gel form; dietary supplements consisting of amino acids in tablet, chewable, powder, capsule, liquid or gel form; dietary supplements consisting of minerals in tablet, chewable, powder, capsule, liquid or gel form; dietary supplements consisting of vitamins in tablet, chewable, powder, capsule, liquid or gel form; dietary supplements consisting primarily of iron in tablet, chewable, powder, capsule, liquid or gel form; dietary supplements for body weight control in tablet, chewable, powder, capsule, liquid or gel form; dietary supplements for controlling cholesterol in tablet, chewable, powder, capsule, liquid or gel form; dietary supplements for general health and well-being in tablet, chewable, powder, capsule, liquid or gel form; dietary supplements consisting of oligosaccharides in tablet, chewable, powder, capsule, liquid or gel form; dietary supplements consisting of hop extracts for general health and well-being in tablet, chewable, powder, capsule, liquid and gel form; dietary supplements consisting of matured hop extracts for general health and well-being in tablet, chewable, powder, capsule, liquid and gel form; dietary supplements consisting of hop extracts for reducing cholesterol in tablet, chewable, powder, capsule, liquid and gel form; dietary supplements consisting of matured hop extracts for reducing cholesterol in tablet, chewable, powder, capsule, liquid and gel form; dietary supplements consisting of hop extracts for reducing body fat in tablet, chewable, powder, capsule, liquid and gel form; dietary supplements consisting of matured hop extracts for reducing body fat in tablet, chewable, powder, capsule, liquid and gel form; dietary supplements consisting of hop extracts for maintaining cognitive function in tablet, chewable, powder, capsule, liquid and gel form; and dietary supplements consisting of matured hop extracts

for maintaining cognitive function in tablet, chewable, powder, capsule, liquid and gel form; dietary supplements consisting of lactic acid bacteria in tablet, chewable, powder, capsule, liquid or gel form; lactic acid bacteria-based food supplements in gel, tablet, chewable, powder, capsule or liquid form; food thickener for dysphagia (swallowing assisting food) for medical purposes; diabetic fruit juice beverages adapted for medical purposes; electrolyte replacement beverages for medical purposes; malted milk beverages for invalids; medicated beverages in the nature of dietary supplements for colon detoxification; medicated beverages in the nature of dietary supplements for liver detoxification; dietetic sugar for medical purposes; dietetic substances consisting of vitamins, minerals, amino acids and trace elements; dietetic substances consisting of oligosaccharides; dietetic substances consisting of hop extracts adapted for medical use for the prevention and treatment of iron deficiency and anaemia in humans; dietetic substances consisting of matured hop extracts adapted for medical use for the prevention and treatment of iron deficiency and anaemia in humans; dietetic substances consisting of hop extracts for reducing body fat; dietetic substances consisting of matured hop extracts for reducing body fat; dietetic substances consisting of hop extracts for maintaining cognitive function; and dietetic substances consisting of matured hop extracts for maintaining cognitive function; dietetic substances consisting of lactic acid bacteria; beverages for babies; food for babies; nutritional supplements for animal foodstuffs; glucose dietary supplements for animals; herbal and dietary supplements to aid in milk production in lactating animals; linseed dietary supplements for animals; mineral dietary supplements for animals; yeast dietary supplements for animals; oligosaccharides dietary supplements for animals; hop extracts-dietary supplements for animals containing cannabis for medicinal purposes; matured hop extracts-dietary supplements for animals containing cannabis for medicinal purposes; hop extracts-dietary supplements for animals for the prevention and treatment of iron deficiency and anaemia in animals; matured hop extracts-dietary supplements for animals for the prevention and treatment of iron deficiency and anaemia in animals; hop extracts-dietary supplements for animals for reducing body fat; matured hop extracts-dietary supplements for animals for reducing body fat; hop extracts-dietary supplements for animals for maintaining cognitive function; and matured hop extracts-dietary supplements for animals for maintaining cognitive function; lactic acid bacteria-dietary supplements for animals; animal semen for artificial insemination; cultures of microorganisms for medical and veterinary laboratory use; cultures of microorganisms for medical and veterinary use, namely for treating disease.

Application Number 1,955,956
Language of Application English

Filing Date 2019-04-08

APPLICANT AND AGENT DETAILS

Applicant

Cambridge LLP
333 Adelaide Street West
4th Floor
Toronto
ONTARIO
M5V1R5

Agent

JOHN H. SIMPSON
(SHIFT LAW PROFESSIONAL
CORPORATION), 60 St. Clair Ave. East, Suite
403, Toronto, ONTARIO, M4T1N5

TRADEMARK DETAILS

Trademark Type

Design

Visual Representation



Services

Class 45

legal services

Application Number 1,956,589
Language of Application English

Filing Date 2019-04-10

APPLICANT AND AGENT DETAILS

Applicant

The Procter & Gamble Company
One Procter & Gamble Plaza
Cincinnati, OH 45202
UNITED STATES OF AMERICA

Agent

WILSON LUE LLP
250 University Avenue, 5th Floor, Toronto,
ONTARIO, M5H3E5

TRADEMARK DETAILS

LIQUICAPS

Trademark Type

Word

Goods

Class 05

pharmaceutical preparations for the treatment of gastro-intestinal diseases; pharmaceutical preparations for the treatment of gastrointestinal disorders

Application Number 1,956,879
Language of Application English

Filing Date 2019-04-11

APPLICANT AND AGENT DETAILS

Applicant

FAIRWAY ELECTRICAL SERVICES
INCORPORATED
PO Box 81125 Fiddlersgreen
Ancaster
ONTARIO
L9G4X1

Agent

SERENA R. LEE
(SIMPSONWIGLE LAW LLP), 1006 Skyview
Drive, Suite 103, Burlington, ONTARIO,
L7P0V1

TRADEMARK DETAILS

TRADETRAKS

Trademark Type

Word

Goods

Class 09

computer software to track sales, expenses, and payments;

Services

Class 42

software as a service (SaaS) provider in the field of human resources management;

Application Number 1,956,880
Language of Application English

Filing Date 2019-04-11

APPLICANT AND AGENT DETAILS

Applicant

FAIRWAY ELECTRICAL SERVICES
INCORPORATED
PO Box 81125 Fiddlersgreen
Ancaster
ONTARIO
L9G4X1

Agent

SERENA R. LEE
(SIMPSONWIGLE LAW LLP), 1006 Skyview
Drive, Suite 103, Burlington, ONTARIO,
L7P0V1

TRADEMARK DETAILS

Trademark Type

Design

Visual Representation



Goods

Class 09

computer software to track sales, expenses, and payments;

Services

Class 42

software as a service (SaaS) provider in the field of human resources management;

Application Number 1,956,996
Language of Application English

Filing Date 2019-04-12

APPLICANT DETAILS

Applicant

CHIH KUANG LO
No.593, Sec.2, Zhongshan Rd., Tantz District.
Taichung City 427
TAIWAN

TRADEMARK DETAILS

Trademark Type

Design

Visual Representation

TEAFECT.1 台茶1号

Foreign Character Translation

The translation provided by the applicant of the Chinese word(s) TAI CHA 1 HAO is TEAFECT.1.

Foreign Character Transliteration

As provided by the applicant, the Chinese characters mean 'TAI CHA 1 HAO'.

Goods

Class 29

(1) coconut milk beverages; fruit bars; fruit jellies; fruit-based snack food; milk; milk and milk products; milk shakes; milk solids

Class 30

(2) beverages made of tea; coffee; fruit sauce; fruit teas; herbal tea beverages; non-alcoholic tea-based beverages; sugar confectionery; tea

Class 32

(3) coconut water beverages; fruit beverages; fruit juices; fruit-based soft drinks flavored with tea; non-alcoholic beverages flavored with tea; sherbet beverages; syrups for making whey-based beverages

Services

Class 35

(1) advertising agency services; auctioneering; import-export agency services; online sales of food items; operating marketplaces; providing advice in the field of business management and marketing; providing business marketing information for others

Class 43

(2) bar services; cafeteria services; catering in fast-food cafeterias; catering of food and drinks; coffee and tea bars; juice bars; milk bar services; snack bar services; tea room services

Application Number 1,957,300
Language of Application English

Filing Date 2019-04-15

APPLICANT AND AGENT DETAILS

Applicant

ABG-Nine West, LLC
1411 Broadway, Fourth Floor
New York, NY 10018
UNITED STATES OF AMERICA

Agent

GOWLING WLG (CANADA) LLP
SUITE 2600, 160 ELGIN STREET, OTTAWA,
ONTARIO, K1P1C3

TRADEMARK DETAILS

NINE WEST

Trademark Type

Word

Goods

Class 25

Clothing, namely, pants, jeans, shirts, T-shirts, sweaters, sweatshirts, sweatpants, shorts, skirts, dresses, coats, jackets, raincoats, snow suits, vests, suits, scarves, gloves, mittens, socks, hosiery, leggings, belts, underwear, lingerie, swimwear, loungewear, sleepwear, robes, neckties, aprons; headwear, namely, hats, caps, headbands, sweatbands and sleep masks; footwear, namely, boots, sneakers, slippers, sandals, moccasins, dress shoes, pumps, heels, loafers, oxfords, insoles.

Application Number 1,957,453
Language of Application English

Filing Date 2019-04-15

APPLICANT AND AGENT DETAILS

Applicant

Dogkind Services Inc.
481 Tipperton Cres
Oakville
ONTARIO
L6L5E1

Agent

ROBERT J. WISE
(WISES PROFESSIONAL CORPORATION),
Suite 200, Argus Corporate Centre, 586 Argus
Road , Oakville, ONTARIO, L6J3J3

TRADEMARK DETAILS

DOGKIND

Trademark Type

Word

Services

Class 41

(1) animal training; educational services in the field of pet care;

Class 43

(2) boarding for animals; dog day care services;

Class 45

(3) dog walking services; pet sitting;

Application Number 1,957,459
Language of Application English

Filing Date 2019-04-15

APPLICANT AND AGENT DETAILS

Applicant

Father, Son & Friends Spirits Inc.
44 Laird Drive
Toronto
ONTARIO
M4G3T2

Agent

CHITIZ PATHAK LLP
77 King Street West, TD North Tower, Suite
700, P.O. Box 118, Toronto, ONTARIO,
M5K1G8

TRADEMARK DETAILS

Trademark Type

Design

Visual Representation



Goods

Class 25

(1) promotional caps; promotional t-shirts;

Class 33

(2) whiskey;

Application Number 1,957,461
Language of Application English

Filing Date 2019-04-15

APPLICANT AND AGENT DETAILS

Applicant

Columbia Insurance Company
1314 Douglas Street, Suite 1400
Omaha, NE 68102-1944
UNITED STATES OF AMERICA

Agent

NORTON ROSE FULBRIGHT CANADA LLP/S.
E.N.C.R.L.,S.R.L.
1, Place Ville Marie, Suite 2500, Montreal,
QUEBEC, H3B1R1

TRADEMARK DETAILS

YOUR DISHES, MORE NUTRITIOUS

Trademark Type

Standard Characters

Goods

Class 05

Powdered dietary and nutritional supplements for general health and well being

Services

Class 35

shop-at-home party services featuring powdered nutritional supplements

Application Number 1,957,466
Language of Application English

Filing Date 2019-04-15

APPLICANT AND AGENT DETAILS

Applicant

Father, Son & Friends Spirits Inc.
44 Laird Drive
Toronto
ONTARIO
M4G3T2

Agent

CHITIZ PATHAK LLP
77 King Street West, TD North Tower, Suite
700, P.O. Box 118, Toronto, ONTARIO,
M5K1G8

TRADEMARK DETAILS

Trademark Type

Design

Visual Representation



Goods

Class 33

whiskey;

Application Number 1,957,695
Language of Application English

Filing Date 2019-04-16

APPLICANT AND AGENT DETAILS

Applicant

St. Jude Medical, LLC
One St. Jude Medical Drive
St. Paul, MN 55117
UNITED STATES OF AMERICA

Agent

BAKER & MCKENZIE LLP
BROOKFIELD PLACE, 181 BAY STREET,
SUITE 2100, P.O. BOX 874, TORONTO,
ONTARIO, M5J2T3

TRADEMARK DETAILS

SHARPSENSE

Trademark Type

Standard Characters

Goods

Class 10

Insertable cardiac medical devices incorporating a detection algorithm designed to detect and treat arrhythmias

Claims

Priority Filing Date: April 15, 2019, Country or Office: UNITED STATES OF AMERICA, Application No: 88386779 in association with the same kind of goods

Application Number 1,958,031
Language of Application English

Filing Date 2019-04-17

APPLICANT DETAILS

Applicant

Kyung Rok Lee
303-2968 Burlington Dr.
Coquitlam
BRITISH COLUMBIA
V3B7N4

TRADEMARK DETAILS

HILZO

Trademark Type
Standard Characters

Goods

Class 09

cases for mobile phones; cell phone cases;

Application Number 1,958,055
Language of Application English

Filing Date 2019-04-17

APPLICANT DETAILS

Applicant

Katherine Snyman
3955 Edenstone Rd NW
Calgary
ALBERTA
T3A3Z7

TRADEMARK DETAILS

Love In My Oven

Trademark Type

Word

Services

Class 43

providing information in the field of recipes and cooking from a website;

Application Number 1,958,364
Language of Application English

Filing Date 2019-04-23

APPLICANT DETAILS

Applicant

ANUPAMA ENTERPRISES
33, LALGHAT
BEHIND JAGDISH TEMPLE
313001
P.O. Box 313001
UDAIPUR
INDIA

TRADEMARK DETAILS

ANUENT

Trademark Type

Word

Goods

Class 18

airline travel bags; all purpose sport bags; all-purpose athletic bags; all-purpose carrying bags; all-purpose leather straps; all-purpose sports bags; alpenstocks; animal game bags; animal harnesses; animal hides; animal identification collars; animal leads; animal leashes; animal muzzles; animal skins; animal skins and hides; ankle-mounted wallets; artificial fur; athletic bags; attaché cases; attache cases made of imitation leather; attache cases made of leather; attaché cases of imitation leather; attaché cases of leather; baby backpacks; baby carriers worn on the body; baby carrying bags; baby changing bags; back frames for carrying children; back packs; backpacks; backpacks, book bags, sports bags, bum bags, wallets and handbags; backpacks for carrying babies; baggage tags; bags for campers; bags for carrying animals; bags for climbers; bags for sports; bags for sports clothing; bags for umbrellas; bags made of leather; bags of leather; bandoliers; bands of leather; banknote holders in the nature of wallets; barrel bags; beach bags; beach parasols; beach umbrellas; beachbags; beauty cases; bellybands for dogs; belt bags; belt bags and hip bags; billfolds; bits for animals; bits for horses; blinders; blinders for horses; blinders for poultry to prevent fighting; blinkers for horses; book bags; Boston bags; boxes of imitation leather; boxes of leather; boxes of leather or leather board; boxes of leather or leatherboard; boxes of leatherboard; boxes of vulcanised fibre; boxes of vulcanized fiber; boxes of vulcanized fibre; bridles for horses; bridoons; briefbags; briefcases; briefcases for documents; briefcase-type portfolios; bum bags; bumbags; business card cases; business card cases in the nature of wallets; business cases; calling card cases; cane handles; canes; canes*; canes and walking sticks; canvas bags for shopping; canvas wood carriers; card cases; card wallets; carry-all bags; carryalls; carrying cases for documents; cases for holding keys; cases for keys; cat collars; cat o' nine tails; catalogue cases; cattle skins; chain mesh handbags; chain mesh purses; chain mesh purses of precious metal; chamois leather; change purses; changing bags; charm bags (omamori-ire); children's shoulder bags; chin straps, of leather; choke chains; clothing for animals; clothing for dogs; clothing for domestic pets; clothing for pets; clutch bags; clutch handbags; clutch purses; coats for cats; coats for dogs; coin purse frames; coin purses; coin purses made of leather; coin

purses of precious metal; collars for cats; collars for dogs; collars for pets; collars for pets bearing medical information; compression cubes adapted for luggage; conference folders; conference portfolios; cosmetic bags; cosmetic bags sold empty; cosmetic cases; cosmetic cases sold empty; cosmetic purses; costumes for animals; courier bags; covers for horse saddles; credit card cases; credit card cases of leather; credit card holders; credit card holders of leather; credit card wallets; credit card wallets of leather; cross-body bags; curried skins; cushion padding made for saddlery; daypacks; diaper bags; document cases; document suitcases; dog apparel; dog bellybands; dog clothing; dog coats; dog collars; dog collars and leads; dog leads; dog leashes; dog parkas; dog shoes; drawstring bags; drawstring pouches; duffel bags; duffel bags for travel; duffle bags; duffle bags for travel; electronic pet collars; equestrian brassware; equine boots; equine leg wraps; evening bags; evening handbags; evening purses; face masks for equines; fake fur; falconry hoods; fanny packs; fashion handbags; fastenings for saddles; faux fur; feed bags; feed bags for animals; felt pouches; flexible bags for garments; flight bags; fly masks for animals; fly masks for horses; fly sheets for horses; folding briefcases; folding walking sticks; footlockers; frames for coin purses; frames for luggage; frames for parasols; frames for umbrellas; frames for umbrellas or parasols; fur; fur pelts; furniture coverings of leather; furs; furs sold in bulk; fur-skins; garment bags for travel; garment bags for travel made of leather; garment carriers; garments for pets; general purpose sport trolley bags; gentlemen's handbags; gentlemen's handbags; girths of leather; gladstone bags; goldbeaters' skin; golf bag tags of leather; golf umbrellas; grips for holding shopping bags; grocery tote bags; gym bags; halters; halters for animals; handbag frames; handbag straps; handbags; handbags for ladies; handbags for men; handbags made of imitation leather; handbags made of leather; handbags made of precious metal; handbags, purses and wallets; handles for canes; handles for canes and walking sticks; handles for walking sticks; handles for walking-sticks; handles of canes and walking-sticks; harness bits; harness bridles; harness fittings of iron; harness fittings of precious metal; harness for animals; harness for horses; harness reins; harness straps; harness traces; harnesses and saddlery; harnesses for guiding children; hat boxes for travel; hat boxes of imitation leather; hat boxes of leather; haversacks; headstalls; hides; hiking bags; hiking poles; hiking rucksacks; hiking sticks; hip bags; hipsacks; holdalls; holdalls for sports clothing; hoof guards; horse bits; horse blankets; horse bridles; horse collars; horse fly sheets; horse halters; horse harnesses; horse leg wraps; horse quarter sheets; horse rugs; horse saddles; horse tacks; horse tail wraps; horseshoes; horseshoes made of plastic; horseshoes of metal; hunters' game bags; hunting bags; hunting crops; imitation fur; imitation leather; imitation leather bags; imitation leather cases; imitation leather handbags; imitation leather sold in bulk; industrial packaging containers of leather; infant carriers worn on the body; janome-gasa [Japanese oiled-paper umbrellas]; Japanese oiled-paper umbrellas [janome-gasa]; Japanese paper umbrellas (karakasa); Japanese utility pouches (shingen-bukuro); jewellery bags of textile material sold empty; jockey sticks; karakasa [Japanese paper umbrellas]; key bags; key cases; key cases of imitation leather; key cases of leather; key cases of leather or imitation leather; key pouches; key wallets; key-cases; keycases; key-cases of leather and skins; kid; kit bags; knapsacks; knee-pads for horses; knitted bags; knitting bags; kori wicker trunks; labels of leather; ladies' handbags; leads for animals; leads for dogs; leads for pets; leashes for animals; leashes for dogs; leashes for guiding children; leashes for pets; leather; leather and imitation leather; leather and imitation leather bags; leather and imitations of leather; leather attaché cases; leather bags; leather bags and wallets; leather bags for packaging; leather boxes; leather briefcases; leather cases; leather cases for keys; leather coin purses; leather credit card cases; leather credit card holder; leather credit card holders; leather credit card wallets; leather envelopes for merchandise packaging; leather for furniture; leather for harnesses; leather for shoes; leather handbags; leather hat boxes; leather key cases; leather laces; leather leads; leather leashes; leather luggage straps; leather luggage tags; leather notecases; leather pouches; leather pouches for merchandise

packaging; leather purses; leather shopping bags; leather shoulder belts; leather shoulder straps; leather sold in bulk; leather straps; leather suitcases; leather thongs; leather thread; leather tool bags; leather travelling bags; leather travelling suitcases; leather trimmings for furniture; leather wallets; leatherboard; leather-board boxes; leatherboard boxes; leathercloth; leg wraps for horses; leggings for animals; lockable luggage straps; lockable straps for luggage; luggage; luggage and trunks; luggage label holders; luggage straps; luggage tags; luggage tags for travel baggage; luggage tags made of leather; luggage tags made of metal; luggage tags made of plastic; luggage tags made of rubber; luggage trunks; luggage trunks and suitcases; lunge reins; lunges; make-up bags; make-up bags sold empty; mesh bags for shopping; mesh bags for shopping; mesh shopping bags; mesh shopping bags; messenger bags; messenger bags; metal horseshoes; metal horseshoes; metal luggage tags; metal luggage tags; metal parts of canes and walking-sticks; metal parts of canes and walking-sticks; metal parts of umbrellas; metal parts of umbrellas; motorized suitcases; motorized suitcases; mountaineering sticks; mountaineering sticks; multi-purpose handbags; multi-purpose handbags; multi-purpose purses; multi-purpose purses; multipurpose purses; multipurpose purses; music bags; music bags; music cases; music cases; name card cases; name card cases; nappy bags; nappy bags; net bags for shopping; net bags for shopping; nose bags; nose bags; omamori-ire [charm bags]; omamori-ire [charm bags]; overnight bags; overnight bags; overnight suitcases; overnight suitcases; packaging bags of leather; packaging bags of leather; pads for riding saddles; pads for riding saddles; parasols; parasols; parasols and walking sticks; parasols and walking sticks; parts of rubber for stirrups; parts of rubber for stirrups; pelts; pelts; pet clothing; pet clothing; pet collars; pet collars; pet collars bearing medical information; pet collars bearing medical information; pet leads; pet leads; pet leashes; pet leashes; plastic luggage labels; plastic luggage labels; plastic luggage tags; plastic luggage tags; pocket wallets; pocket wallets; pocketbooks; pocketbooks; portmanteau; portmanteau; portmanteaus; portmanteaus; portmanteaux; portmanteaux; pouch baby carriers; pouch baby carriers; pouches for holding keys; pouches for holding keys; pouches of leather; pouches of leather; poultry blinders to prevent fighting; poultry blinders to prevent fighting; poultry blinkers to prevent fighting; poultry blinkers to prevent fighting; protective suit carriers; protective suit carriers; Pullman cases; Pullman cases; purse frames; purse frames; purses; purses; purses and wallets; purses and wallets; rainproof parasols; rainproof parasols; randsels [Japanese school satchels]; randsels [Japanese school satchels]; raw hides; raw hides; raw skins; raw skins; rawhide chews for dogs; rawhide chews for dogs; rawhides; rawhides; reins for equestrian sports; reins for equestrian sports; reins for guiding children; reins for guiding children; reticule; reticule; reticules; reticules; reusable shopping bags; reusable shopping bags; riding crops; riding crops; riding saddles; riding saddles; roll bags; roll bags; roller bags; roller bags; roller suitcases; roller suitcases; rubber luggage tags; rubber luggage tags; rubber parts for stirrups; rubber parts for stirrups; ruckpaks; ruckpaks; rucksacks; rucksacks; rucksacks for mountaineers; rucksacks for mountaineers; rucksacks on casters; rucksacks on casters; saddle belts; saddle belts; saddle blankets; saddle blankets; saddle cloths for horses; saddle cloths for horses; saddle covers; saddle covers; saddle trees; saddle trees; saddlebags; saddlebags; saddlecloths for horses; saddlecloths for horses; saddlery; saddlery; saddlery of leather; saddlery of leather; saddles; saddles; saddletrees; saddletrees; satchels; satchels; school backpacks; school backpacks; school bags; school bags; school book bags; school book bags; school knapsacks; school knapsacks; school satchels; school satchels; schoolbags; schoolbags; schoolchildren's backpacks; schoolchildren's backpacks; semi-worked fur; semi-worked fur; shaving bags sold empty; shaving bags sold empty; shingen-bukuro [Japanese utility pouches]; shingen-bukuro [Japanese utility pouches]; shoe bags; shoe bags; shoe bags for travel; shoe bags for travel; shopping bags; shopping bags; shopping bags made of skin; shopping bags made of skin; shopping bags with wheels attached; shopping bags with wheels attached; shoulder bags; shoulder bags; shoulder belts of leather; shoulder belts

of leather; shoulder straps; shoulder straps; shoulder straps of leather; shoulder straps of leather; skins and hides; skins and hides; sling bags for carrying babies; sling bags for carrying babies; sling bags for carrying infants; sling bags for carrying infants; slings for carrying infants; slings for carrying infants; slouch handbags; slouch handbags; small backpacks; small backpacks; small bags for men; small bags for men; small clutch handbags; small clutch handbags; small clutch purses; small clutch purses; small coin purses; small coin purses; small handbags; small handbags; small purses; small purses; small rucksacks; small rucksacks; small suitcases; small suitcases; souvenir bags; souvenir bags; spats and knee bandages for horses; spats and knee bandages for horses; specialty holsters adapted for carrying folding walking sticks; specialty holsters adapted for carrying folding walking sticks; sponge bags; sponge bags; sport bags; sport bags; sports bags; sports bags; sports packs; sports packs; sportsman's hunting bags; sportsman's hunting bags; stirrup leathers; stirrup leathers; stirrup straps; stirrup straps; stirrups; stirrups; stirrups of metal; stirrups of metal; straps for coin purses; straps for coin purses; straps for handbags; straps for handbags; straps for luggage; straps for luggage; straps for skates; straps for skates; straps for soldiers' equipment; straps for soldiers' equipment; string bags for shopping; string bags for shopping; suit bags; suit bags; suit bags for travel; suit bags for travel; suit carriers; suit carriers; suitcase handles; suitcase handles; suitcases; suitcases; suitcases with wheels; suitcases with wheels; sun umbrellas; sun umbrellas; sunshade parasols; sunshade parasols; synthetic fur; synthetic fur; synthetic leather; synthetic leather; tail wraps for horses; tail wraps for horses; tanned leather; tanned leather; telescopic umbrellas; telescopic umbrellas; textile shopping bags; textile shopping bags; tie cases; tie cases; tie cases for travel; tie cases for travel; tips specially adapted for hiking poles; tips specially adapted for hiking poles; tips specially adapted for hiking sticks; tips specially adapted for hiking sticks; tips specially adapted for trekking poles; tips specially adapted for trekking poles; tips specially adapted for trekking sticks; tips specially adapted for trekking sticks; tips specially adapted for wading staffs; tips specially adapted for wading staffs; tips specially adapted for walking staffs; tips specially adapted for walking staffs; tips specially adapted for walking sticks; tips specially adapted for walking sticks; toilet bags; toilet bags; toiletry bags; toiletry bags; toiletry bags sold empty; toiletry bags sold empty; toiletry cases sold empty; toiletry cases sold empty; tool bags; tool bags; tool bags of leather; tool bags of leather; tool bags sold empty; tool bags sold empty; tool pouches sold empty; tool pouches sold empty; tote bags; tote bags; train cases; train cases; training leads; training leads; training leads for horses; training leads for horses; travel bags; travel bags; travel cases; travel cases; travel garment covers; travel garment covers; travel handbags; travel handbags; travel kits; travel kits; travel luggage; travel luggage; travel trunks; travel trunks; travel wallets; travel wallets; travelling bags; travelling bags; travelling cases of leather; travelling cases of leather; travelling trunks; travelling trunks; trekking poles; trekking poles; trekking sticks; trekking sticks; trimmings of leather for furniture; trimmings of leather for furniture; trolley bags; trolley bags; trolley duffel bags; trolley duffel bags; trolley duffels; trolley duffels; trolley suitcases; trolley suitcases; trolley-type suitcases; trolley-type suitcases; trunks and suitcases; trunks and suitcases; umbrella covers; umbrella covers; umbrella frames; umbrella frames; umbrella handles; umbrella handles; umbrella or parasol ribs; umbrella or parasol ribs; umbrella rings; umbrella rings; umbrella sticks; umbrella sticks; umbrellas; umbrellas; umbrellas and parasols; umbrellas and parasols; umbrellas and their parts; umbrellas and their parts; umbrellas for children; umbrellas for children; unfitted vanity cases; unfitted vanity cases; un-worked leather; un-worked leather; unworked leather; unworked leather; unwrought and semi-wrought leather; unwrought and semi-wrought leather; valises; valises; vanity cases; vanity cases; vanity cases sold empty; vanity cases sold empty; wading staffs; wading staffs; waist bags; waist bags; waist packs; waist packs; waist pouches; waist pouches; walking cane handles; walking cane handles; walking canes; walking canes; walking staffs; walking staffs; walking stick handles; walking stick handles; walking stick seats; walking

stick seats; walking sticks; walking sticks; wallet fobs; wallet fobs; wallets; wallets; wallets for attachment to belts; wallets for attachment to belts; wallets including card holders; wallets including card holders; wallets of precious metal; wallets of precious metal; wallets with card compartments; wallets with card compartments; wash bags for carrying toiletries; wash bags for carrying toiletries; weekend bags; weekend bags; wheeled bags; wheeled bags; wheeled shopping bags; wheeled shopping bags; wheeled suitcases; wheeled suitcases; whips; whips; whips and saddlery; whips and saddlery; wrist-mounted money purses; wrist-mounted money purses; wrist-mounted wallets; wrist-mounted wallets

Application Number 1,958,367
Language of Application English

Filing Date 2019-04-23

APPLICANT DETAILS

Applicant

Arvinder Benga
6939 Butler St
Vancouver
BRITISH COLUMBIA
V5S3L1

TRADEMARK DETAILS

Trademark Type

Design

Visual Representation



The logo consists of the words "BIRDMAN GARAGE" in a bold, uppercase, sans-serif font. Two diagonal lines are positioned around the text: one above "GARAGE" and one below "BIRDMAN".

Goods

Class 25

after-ski boots; albs; altar clothes; anglers' shoes; ankle boots; ankle socks; anklet socks; anoraks; anti-perspirant socks; anti-slip soles; aprons; aqua shoes; ascots; athletic apparel; athletic clothing; athletic footwear; athletic shoes; athletic shorts; athletic tights; athletic wear; baby bottoms; baby clothing; baby doll pyjamas; baby layettes for clothing; baby pants; body suits

Application Number 1,958,368
Language of Application French

Filing Date 2019-04-23

APPLICANT DETAILS

Applicant

Francis Pascaud
1690 rue des Rigoles
Sherbrooke
QUÉBEC
J1M2H2

TRADEMARK DETAILS

Steward Bags

Trademark Type

Word

Goods

Class 18

Reusable bags made of organic cotton for food products.

Application Number 1,958,472
Language of Application English

Filing Date 2019-04-23

APPLICANT AND AGENT DETAILS

Applicant

Mood Honey Ltd.
56 Twenty Street
Toronto
ONTARIO
M8V3R7

Agent

DEETH WILLIAMS WALL LLP
150 YORK STREET, SUITE 400, TORONTO,
ONTARIO, M5H3S5

TRADEMARK DETAILS

MOOD HONEY

Trademark Type

Word

Goods

Class 03

bath additives; bath gels; bath lotions; bath oils; bath soaps; body and beauty care cosmetics; fragrances for personal use;

Application Number 1,959,114
Language of Application English

Filing Date 2019-04-25

APPLICANT AND AGENT DETAILS

Applicant

Ojo Labs, Inc.
720 Brazos Street #101
Austin, TX 78701
UNITED STATES OF AMERICA

Agent

CASSELS BROCK & BLACKWELL LLP
SCOTIA PLAZA, SUITE 2100, 40 KING
STREET WEST, TORONTO, ONTARIO,
M5H3C2

TRADEMARK DETAILS

OJO HOME

Trademark Type

Standard Characters

Goods

Class 09

Computer software for providing for interaction of a user with a conversational user interface for the distribution of consumer information in the field of real estate; computer software for retrieving information from a user and delivering to the user context-sensitive information and user-specific information in the field of consumer information in connection with real estate; computer software for transmitting information to a user from an adaptive, artificially intelligent software agent in the field of consumer information in connection with real estate; computer software in the field of artificial intelligence, namely, software for converting natural language voice and text into machine executable commands; computer software, namely, an interpretive interface for facilitating interaction between humans and computers and mobile phones via voice and text message-enabled conversational agents and chat bots; computer software used to process natural language voice and text commands, and create natural language voice and text responses to voice and text commands; computer software for providing purchase information in response to voice and text data; computer software for providing information on home-buying process and purchase information in response to voice and text data; computer software, namely, an interactive interface for receiving consumer preference information and providing information about real estate available for sale; computer software, namely, an interactive interface for receiving consumer preference information and providing information about real estate available for sale; computer application software for mobile phones, portable media players, and handheld computers, namely, artificial intelligence and natural language processing software for providing instructional data and information for searching, locating, rating, evaluating and providing directions for the purchase of real estate and consumer products and services; computer application software for mobile phones, portable media players, and handheld computers, namely, artificial intelligence and natural language processing software for providing instructional data and information for searching, locating, rating, evaluating and providing directions for the home-buying process; computer software for providing information relating to the home-buying process; computer software for use in finding services providers in the fields of real estate, mortgages, moving services, home services, title services and insurance; computer software that functions as a virtual personal assistant for users of computers and mobile phones; computer application software for mobile phones, namely, software for use in finding services providers in the fields of real estate and

mortgages; computer software for use in finding services providers for use in the fields of real estate and mortgages; computer software for providing information to consumers in the fields of mortgages, moving services, home services, title services.

Services

Class 36

(1) Providing information to consumers in the fields of real estate, mortgage financing, real estate title insurance underwriting services and insurance; providing real estate listings via the Internet and text messaging.

Class 37

(2) Providing information to consumers in the field of home repair services.

Class 39

(3) Providing information to consumers in the field of moving services.

Class 42

(4) Providing on-line, non-downloadable software for identifying preferences of consumers and matching preferences to consumer products and services in the marketplace; providing on-line, non-downloadable software for identifying preferences of consumers and matching preferences to available real estate in the marketplace; providing on-line, non-downloadable survey software which can produce real estate matching reports and individualized real estate preference reports and identify best match candidates for real estate purchase; providing temporary use of on-line non-downloadable computer software for retrieving information from a user and delivering to the user context-sensitive information and user-specific information in the fields of real estate, mortgage financing, and mortgage insurance; providing temporary use of on-line nondownloadable computer software for transmitting information in the fields of real estate, mortgage financing, and mortgage insurance to a user from an adaptive, artificially intelligent software agent; providing temporary use of on-line non-downloadable computer software for providing consumer products and services features and purchase information in response to voice and text data; providing temporary use of on-line non-downloadable computer software for providing real estate market and purchase information in response to voice and text data; providing temporary use of on-line non-downloadable computer software featuring an interactive interface for receiving consumer preference information and providing information about real estate, mortgages, moving services, home services, title services and insurance.

Class 45

(5) Providing information to consumers in the field of title searching services.

Claims

Priority Filing Date: March 12, 2019, Country or Office: UNITED STATES OF AMERICA,
Application No: 88/336,905 in association with the same kind of goods and in association with the same kind of services

Application Number 1,959,115
Language of Application English

Filing Date 2019-04-25

APPLICANT AND AGENT DETAILS

Applicant

Ojo Labs, Inc.
720 Brazos Street #101
Austin, TX 78701
UNITED STATES OF AMERICA

Agent

CASSELS BROCK & BLACKWELL LLP
SCOTIA PLAZA, SUITE 2100, 40 KING
STREET WEST, TORONTO, ONTARIO,
M5H3C2

TRADEMARK DETAILS

Trademark Type

Design

Visual Representation



Goods

Class 09

Computer software for providing for interaction of a user with a conversational user interface for the distribution of consumer information in the field of real estate; computer software for retrieving information from a user and delivering to the user context-sensitive information and user-specific information in the field of consumer information in connection with real estate; computer software for transmitting information to a user from an adaptive, artificially intelligent software agent in the field of consumer information in connection with real estate; computer software in the field of artificial intelligence, namely, software for converting natural language voice and text into machine executable commands; computer software, namely, an interpretive interface for facilitating interaction between humans and computers and mobile phones via voice and text message-enabled conversational agents and chat bots; computer software used to process natural language voice and text commands, and create natural language voice and text responses to voice and text commands; computer software for providing purchase information in response to voice and text data; computer software for providing information on home-buying process and purchase information in response to voice and text data; computer software, namely, an interactive interface for receiving consumer preference information and providing information about real estate available for sale; computer software, namely, an interactive interface for receiving consumer preference information and providing information about real estate available for sale; computer application software for mobile phones, portable media players, and handheld computers, namely, artificial intelligence and natural language processing software for providing instructional data and information for searching, locating, rating, evaluating and providing directions for the purchase of real estate and consumer products and services; computer application software for mobile phones, portable media players, and handheld computers, namely, artificial intelligence and natural language processing software for providing instructional data and information for searching, locating, rating, evaluating and providing directions for the home-buying process; computer software for providing information relating to the home-buying process; computer software for use

in finding services providers in the fields of real estate, mortgages, moving services, home services, title services and insurance; computer software that functions as a virtual personal assistant for users of computers and mobile phones; computer application software for mobile phones, namely, software for use in finding services providers in the fields of real estate and mortgages; computer software for use in finding services providers for use in the fields of real estate and mortgages; computer software for providing information to consumers in the fields of mortgages, moving services, home services, title services.

Services

Class 36

(1) Providing information to consumers in the fields of real estate, mortgage financing, real estate title insurance underwriting services and insurance; providing real estate listings via the Internet and text messaging.

Class 37

(2) Providing information to consumers in the field of home repair services.

Class 39

(3) Providing information to consumers in the field of moving services.

Class 42

(4) Providing on-line, non-downloadable software for identifying preferences of consumers and matching preferences to consumer products and services in the marketplace; providing on-line, non-downloadable software for identifying preferences of consumers and matching preferences to available real estate in the marketplace; providing on-line, non-downloadable survey software which can produce real estate matching reports and individualized real estate preference reports and identify best match candidates for real estate purchase; providing temporary use of on-line non-downloadable computer software for retrieving information from a user and delivering to the user context-sensitive information and user-specific information in the fields of real estate, mortgage financing, and mortgage insurance; providing temporary use of on-line nondownloadable computer software for transmitting information in the fields of real estate, mortgage financing, and mortgage insurance to a user from an adaptive, artificially intelligent software agent; providing temporary use of on-line non-downloadable computer software for providing consumer products and services features and purchase information in response to voice and text data; providing temporary use of on-line non-downloadable computer software for providing real estate market and purchase information in response to voice and text data; providing temporary use of on-line non-downloadable computer software featuring an interactive interface for receiving consumer preference information and providing information about real estate, mortgages, moving services, home services, title services and insurance.

Class 45

(5) Providing information to consumers in the field of title searching services.

Claims

Priority Filing Date: March 12, 2019, Country or Office: UNITED STATES OF AMERICA, Application No: 88/336,901 in association with the same kind of goods and in association with the same kind of services

Application Number 1,959,228
Language of Application English

Filing Date 2019-04-25

APPLICANT AND AGENT DETAILS

Applicant

Paisley Park Enterprises, LLC
7801 Audubon Road
Chanhassen, MN 55317
UNITED STATES OF AMERICA

Agent

BERESKIN & PARR LLP/S.E.N.C.R.L., S.R.L.
SCOTIA PLAZA, 40 KING STREET WEST,
40th FLOOR, TORONTO, ONTARIO, M5H3Y2

TRADEMARK DETAILS

Trademark Types

Design
Three-dimensional (3-D)

Visual Representation

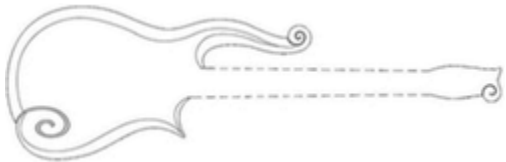

Trademark Description

The mark consists of a three dimensional configuration of a highly stylized guitar body and headstock. The broken lines are not a part of the mark and serve only to show the position of the mark.

Goods

Class 15

guitars

Claims

Priority Filing Date: October 31, 2018, Country or Office: UNITED STATES OF AMERICA,
Application No: 88176214 in association with the same kind of goods

Application Number 1,959,306
Language of Application English

Filing Date 2019-04-25

APPLICANT AND AGENT DETAILS

Applicant

Timothy Sellner Dentistry Professional
Corporation c.o.b. TechTown Dentistry
1-180 Northfield Drive West
Waterloo
ONTARIO
N2L0C7

Agent

D. MICHAEL BEAN
(Michael Bean Trademark & Copyright Law), P.
O. Box 1737, STN GALT, Cambridge,
ONTARIO, N1R7G8

TRADEMARK DETAILS

TECHTOWN DENTISTRY

Trademark Type

Word

Services

Class 44

dentist services;

Application Number 1,959,362
Language of Application English

Filing Date 2019-04-25

APPLICANT DETAILS

Applicant

Fariz Merchant
2-1135 Avenue Rd
Toronto
ONTARIO
M5N2E7

TRADEMARK DETAILS

iMerch

Trademark Type

Word

Goods

Class 24

bed and table linen; bed blankets; bed blankets made of cotton; bed blankets made of man-made fibres; bed blankets made of wool; bed canopies; bed covers; bed covers of paper; bed linen; bed linen of paper; bed pads; bed quilts; bed sheet sets; bed sheets; bed sheets for children; bed sheets of paper; bed skirts; bed spreads; bed throws; bed valances; blankets; pillow cases; pillow covers; pillow protectors; pillow shams; pillow slips; sheets; textile fabrics for use in the manufacture of bedding;

Application Number 1,959,667
Language of Application English

Filing Date 2019-04-29

APPLICANT DETAILS

Applicant

Ricardo Revoredo
173 Christie St
Toronto
ONTARIO
M6G3B3

TRADEMARK DETAILS

Trademark Type

Design

Visual Representation



Colour Claim

Colour is claimed as a feature of the trademark. The colours claimed as a feature of the trademark are green and white, the principal parts of the trademark that are in the colour green are the rectangular outline, the outline of the house shape and the silhouette of the tree. The remainder of the trademark is white.

Services

Class 35

(1) business project management services for construction projects

Class 36

(2) estimating construction costs

Class 37

(3) building construction contracting services; building demolition; construction and renovation of buildings; construction and repair of buildings; consultation in building construction supervision; house building and repair; plastering services

Class 42

(4) construction planning

Class 44

(5) landscape design; landscape design and gardening services; landscape gardening; landscape gardening design for others

Application Number 1,959,867
Language of Application English

Filing Date 2019-04-29

APPLICANT AND AGENT DETAILS

Applicant
OBSHESTVO S OGRANICHENNOY
OTVETSTVENNOSTYU 'MAY'
1a Ozernaya
RU-141191 Fryazino, Moskovskoy obl.
RUSSIAN FEDERATION

Agent
NEOMARK LTD.
7450 rue Saint-Hubert, Montréal, QUEBEC,
H2R2N3

TRADEMARK DETAILS

Trademark Type
Design

Visual Representation



Colour Claim

Colour is claimed as a feature of the trade-mark. The word MAYSKIY is white. The background is red and dark red. The crown and the shield figurative elements are bronze.

Foreign Character Translation

The translation of MAYSKIY is 'of May'.

Foreign Character Transliteration

The transliteration of the Russian word present in the trademark is MAYSKIY.

Goods

Class 30

tea

Application Number 1,959,933
Language of Application English

Filing Date 2019-04-29

APPLICANT AND AGENT DETAILS

Applicant

GILAN IMPORT EXPORT LTD.
2120 - 1368 KINGSWAY AVE.
PORT COQUITLAM
BRITISH COLUMBIA
V3C6P4

Agent

ACCUPRO TRADEMARK SERVICES LLP
SUITE 702 - 401 WEST GEORGIA STREET,
VANCOUVER, BRITISH COLUMBIA, V6B5A1

TRADEMARK DETAILS

GILAN FOODNEH FARD

Trademark Type

Standard Characters

Foreign Character Translation

As provided by the applicant, FOODNEH the name of a mint-like herb; and FARD means 'the number one'.

Goods

Class 29

(1) baked beans; canned vegetables; canned, dried, pickled, fried and steamed vegetables; cheese; dairy products; dates; dried beans; jams; kashk being drained and dried yogurt; kefir; lime juice for culinary purposes; pickled cucumbers; pickled garlic; pickled vegetables; pickles; pomegranate paste; potato chips; prepared meals consisting primarily of cooked vegetables; preserved olives; tahini [sesame seed paste]; tomato paste; tuna fish; verjuice for culinary purposes; yogurt beverages;

Class 30

(2) bread; cookies; corn-based snack food; crystal sugar for culinary purposes; cube sugar; dried pasta; edible salt; halvah; honey; macaroni; molasses; oxymel syrup; rice; rose water for culinary purpose; spices; sugar; table syrup; tea; vermicelli; vinegar;

Class 32

(3) bottled water; distilled drinking water; fruit beverages and fruit juices; herb-based soda water; lime juice for use in the preparation of beverages; non-alcoholic carbonated drinks; spice-based soda water;

Application Number 1,959,980
Language of Application English

Filing Date 2019-04-30

APPLICANT DETAILS

Applicant

Genki Forest (Beijing) Food Technology Group
Co., Ltd.
Room 501, 5th Floor, Building No. 6
East 3rd Ring North Road
Chaoyang Dist.
Beijing
CHINA

TRADEMARK DETAILS

GENKI FOREST

Trademark Type

Word

Goods

Class 32

Beer; mineral water; non-alcoholic fruit juice beverages; non-alcoholic beverages flavored with tea; soft drinks; vegetable-based beverages; soda water; non-alcoholic beverages with tea flavor; drinking water; table waters; preparations for making aerated water; preparations for making mineral water; fruit concentrates and purées used for making beverages; syrups for making beverages.

Application Number 1,960,044
Language of Application English

Filing Date 2019-04-30

APPLICANT AND AGENT DETAILS

Applicant

Target Brands, Inc.
1000 Nicollet Mall
Minneapolis, MN 55403
UNITED STATES OF AMERICA

Agent

BERESKIN & PARR LLP/S.E.N.C.R.L., S.R.L.
SCOTIA PLAZA, 40 KING STREET WEST,
40th FLOOR, TORONTO, ONTARIO, M5H3Y2

TRADEMARK DETAILS

Trademark Type

Design

Visual Representation

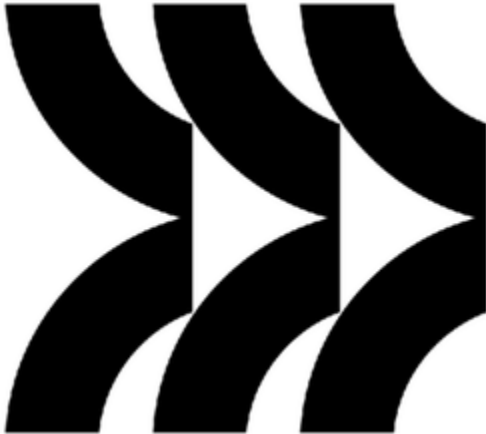

Goods

Class 12

(1) Bicycle tires

Class 21

(2) Water bottles sold empty

Class 24

(3) Towels namely bath towels, beach towels, cloth towels, dish towels for drying, face towels of textile, hand towels, hooded towels, microfiber towels, terry towels

Class 27

(4) Personal exercise mats; fitness mats, namely, meditation mats; yoga mats; yoga towels specially adapted for yoga mats; interlocking exercise mats

Class 28

(5) Fitness and exercise equipment and accessories, namely, ab wheels, balance disks, balance pods, exercise balls, exercise bands, exercise hand grippers, exercise weights, exercise wheels, fitness balls, hand weights, jump ropes, kettle bells, manually operated exercise equipment namely resistance bands for use as sports articles, exercise bands, loop bands in the nature of exercise

bands, speed jump ropes, performance jump ropes, inflatable balls for stability exercises in the nature of exercise balls, sand bag sets, walking weights, weighted balls, exercise steppers, foam exercise rollers namely abdominal wheel rollers for fitness purposes, yoga blocks, work-out gloves; fitness and exercise equipment and accessories for speed training, namely, agility ladders, agility cones, agility hurdles, agility dots, speed chutes and speed trainers in the nature of resistance chutes; fitness and exercise equipment and accessories, namely, balance boards for improving strength, toning, conditioning, balance, and proprioception; fitness and exercise equipment and accessories, namely, spring bars for exercising, namely, body bars; fitness and exercise equipment and accessories, namely, core gliders in the nature of core sliders; fitness and exercise equipment and accessories, namely, cushioned training gloves for gripping weights, not for cold weather use; fitness and exercise equipment and accessories, namely, exercise bands, namely, resistance bands, stepper bands, body bands; pumps for inflating sports equipment, namely, exercise balls; balancing kits comprised of balance boards for improving strength, toning, conditioning, balance, and proprioception; agility kits comprised of agility ladders, agility cones, agility hurdles, agility dots, speed chutes and speed trainers in the nature of resistance chutes

Claims

Priority Filing Date: January 17, 2019, Country or Office: UNITED STATES OF AMERICA,
Application No: 88266448 in association with the same kind of goods (2), (3), (4), (5)

Application Number 1,960,045
Language of Application English

Filing Date 2019-04-30

APPLICANT AND AGENT DETAILS

Applicant

Target Brands, Inc.
1000 Nicollet Mall
Minneapolis, MN 55403
UNITED STATES OF AMERICA

Agent

BERESKIN & PARR LLP/S.E.N.C.R.L., S.R.L.
SCOTIA PLAZA, 40 KING STREET WEST,
40th FLOOR, TORONTO, ONTARIO, M5H3Y2

TRADEMARK DETAILS

Trademark Type

Design

Visual Representation

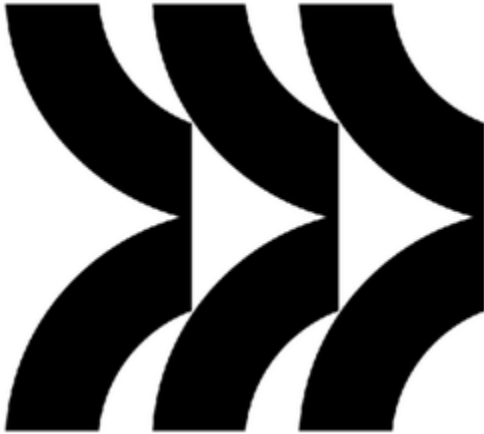

Goods

Class 05

(1) Nutritional and dietary supplements consisting of vitamins and minerals; protein supplements, namely, ready-to-eat protein bars not for medical purposes; meal replacement bars adapted for use as a dietary supplement for medical use; nutritional supplement meal replacement bars for boosting energy

Class 29

(2) Fruit-based meal replacement bars; fruit-based meal replacement bars for boosting energy

Class 30

(3) High-protein cereal bars; chocolate-based meal replacement bars; cereal based energy bars

Claims

Priority Filing Date: January 17, 2019, Country or Office: UNITED STATES OF AMERICA,
Application No: 88266447 in association with the same kind of goods

Application Number 1,960,097
Language of Application English

Filing Date 2019-04-30

APPLICANT AND AGENT DETAILS

Applicant

Kang Tu, Inc.
5362 Via Apolina
Yorba Linda, CA 92886
UNITED STATES OF AMERICA

Agent

MCMILLAN LLP
1500 - 1055 WEST GEORGIA STREET, P.O.
BOX 11117, ROYAL CENTRE, VANCOUVER,
BRITISH COLUMBIA, V6E4N7

TRADEMARK DETAILS

SHANCHENG LAMEIZI

Trademark Type

Word

Foreign Character Translation

As provided by the applicant, the translation of the trademark is Mountain City Spicy Sister.

Services

Class 43

restaurant services

Application Number 1,960,120
Language of Application English

Filing Date 2019-04-30

APPLICANT AND AGENT DETAILS

Applicant

TFI Foods Ltd. / Les Aliments TFI Ltee.
44 Milner Avenue
Scarborough
ONTARIO
M1S3P8

Agent

OSLER, HOSKIN & HARCOURT LLP
SUITE 6200, P.O. BOX 50, 1 FIRST
CANADIAN PLACE, TORONTO, ONTARIO,
M5X1B8

TRADEMARK DETAILS

Trademark Type

Design

Visual Representation



Foreign Character Translation

As provided by the applicant, the translation of the Chinese word(s) "gwok fung" is "sea global".

Foreign Character Transliteration

As provided by the applicant, the transliteration of the Chinese characters is gwok fung.

Goods

Class 29

fish; seafood; shrimps, prawns, and lobsters

Application Number 1,960,137
Language of Application English

Filing Date 2019-04-30

APPLICANT AND AGENT DETAILS

Applicant

Paisley Park Enterprises, LLC
7801 Audubon Road
Chanhassen, MN 55317
UNITED STATES OF AMERICA

Agent

BERESKIN & PARR LLP/S.E.N.C.R.L., S.R.L.
SCOTIA PLAZA, 40 KING STREET WEST,
40th FLOOR, TORONTO, ONTARIO, M5H3Y2

TRADEMARK DETAILS

PRINCE AND THE REVOLUTION

Trademark Type

Word

Authorisation For Use

Consent from the Estate of Prince Rogers Nelson is of record.

Goods

Class 09

- (1) Phonograph records, audio-tapes and compact discs embodying musical performances
- (2) Video tapes embodying musical performances

Application Number 1,960,216
Language of Application English

Filing Date 2019-04-30

APPLICANT AND AGENT DETAILS

Applicant

Bonnie Pomeroy Arenes
50 Eaglestone Lane
Barrie
ONTARIO
L4N0J3

Agent

LISA C. JAMES
(Lisa C James Professional Corporation), 200
Memorial Avenue, Unit #3, Suite 102, Orillia,
ONTARIO, L3V5X6

TRADEMARK DETAILS

COLLECTIVE SPIRIT REIKI

Trademark Type

Word

Services

Class 44

reiki therapy services;

Application Number 1,960,217
Language of Application English

Filing Date 2019-04-30

APPLICANT AND AGENT DETAILS

Applicant

Bonnie Pomeroy Arenes
50 Eaglestone Lane
Barrie
ONTARIO
L4N0J3

Agent

LISA C. JAMES
(Lisa C James Professional Corporation), 200
Memorial Avenue, Unit #3, Suite 102, Orillia,
ONTARIO, L3V5X6

TRADEMARK DETAILS

Trademark Type

Design

Visual Representation



COLLECTIVE SPIRIT
— REIKI —

Services

Class 44

reiki therapy services;

Application Number 1,960,439
Language of Application English

Filing Date 2019-05-01

APPLICANT AND AGENT DETAILS

Applicant

Wilson Sporting Goods Co.
1 Prudential Plaza
130 East Randolph Street, Suite 600
Chicago, IL 60601
UNITED STATES OF AMERICA

Agent

MARKS & CLERK
33 Yonge Street, , Suite 300, Toronto,
ONTARIO, M5E1G4

TRADEMARK DETAILS

Trademark Type

Design

Visual Representation



Goods

Class 09

(1) Sunglasses, protective goggles for sports, eye shields for athletic use, eye shields specially adapted for protective sports helmets, sports eyewear, batter's helmets, protective padded or reinforced clothing for protection against bodily harm and blunt force trauma, protective sports helmet accessories that attach to the helmets, namely, chin straps; catchers' helmets, umpires' helmets, visors and masks specially adapted for such helmets; face shields for athletic use; face shields for sports helmets; protective face-shields for protective helmets; and mouth guards for sports.

Class 10

(2) Body limb compression sleeves for athletic use; compression sleeves for arms.

Class 18

(3) Sports bags, namely, backpacks, general purpose athletic bags for holding athletic equipment, sport travel bags, general purpose wheeled bags for holding sports equipment, duffel bags, sport umbrellas, all-purpose sports equipment bags and attache cases.

Class 25

(4) Shirts, tee shirts, sweat shirts, warm-up shirts, polo shirts, racerback shirts, tank tops, jerseys, hoodies, jackets, pullovers, pants, trousers, sweat pants, training pants, sliding pants, leggings,

capris, shorts, short pants, belts, training shorts, sliding shorts, girdles, padded girdles, sports bras, socks, crew socks, hats, caps, bucket caps, headbands, visors being headwear, balaclavas, bandannas, wristbands as clothing, athletic uniforms; padded or reinforced clothing for athletic use, namely, padded shirts, padded pants, padded shorts; hand muffs; footwear namely shoes, athletic shoes, athletic spiked shoes, gloves, mittens, and skirts.

Class 28

(5) Athletic protective equipment, namely, elbow guards, elbow guard straps, elbow protectors, wrist guards, wrist protectors, wrist guard straps, insertable knee, elbow, thigh, hip, back and chest pads, leg guards, leg guard straps, shin guards, chest protectors, chest guards, chest and back guards, racerback chest guards, back guards, back protectors, back plates, athletic rib protectors, athletic thigh protectors, exercise leg protector, batting gloves, football gloves for receivers and linemen, multi-use athletic protective pads for baseball, softball, football and soccer, thumb guards, baseball and softball bat bags; catcher's protective kits comprised of chest protectors, leg guards and catcher's helmets for athletic use; shoulder pads and throat protectors for athletic use; and sports bags specifically designed to carry athletic equipment.

Claims

Priority Filing Date: November 01, 2018, Country or Office: UNITED STATES OF AMERICA, Application No: 88/177873 in association with the same kind of goods (1), (3), (4), (5)

Application Number 1,960,658
Language of Application English

Filing Date 2019-05-02

APPLICANT AND AGENT DETAILS

Applicant

Plexus Worldwide, LLC
9145 E. Pima Center Parkway
Scottsdale, AZ 85258
UNITED STATES OF AMERICA

Agent

DICKINSON WRIGHT LLP
199 Bay Street, Suite 2200, P.O. Box 447,
Commerce Court : Postal Station, Toronto,
ONTARIO, M5L1G4

TRADEMARK DETAILS

PLEXUS ACTIVE

Trademark Type

Word

Goods

Class 05

dietary and nutritional supplements for general health and wellbeing;

Claims

Priority Filing Date: April 02, 2019, Country or Office: UNITED STATES OF AMERICA, Application No: 88/367,937 in association with the same kind of goods

Application Number 1,960,681
Language of Application English

Filing Date 2019-05-02

APPLICANT AND AGENT DETAILS

Applicant

Urban Lube Limited
1364 Cornwall St
Regina
SASKATCHEWAN
S4R2H5

Agent

FURMAN IP LAW & STRATEGY PC
300 - 1914 HAMILTON STREET, REGINA,
SASKATCHEWAN, S4P3N6

TRADEMARK DETAILS

URBAN LUBE

Trademark Type

Word

Disclaimer

The right to the exclusive use of the word LUBE is disclaimed apart from the trademark.

Services

Class 37

mobile automotive oil change services, delivered at the customer's location

Application Number 1,960,785
Language of Application English

Filing Date 2019-05-03

APPLICANT AND AGENT DETAILS

Applicant

Huge Paper Inc.
3420 Pharmacy Avenue, Suite 6
Scarborough
ONTARIO
M1W2P7

Agent

RIDOUT & MAYBEE LLP
11 Holland Avenue, Suite 601 , Ottawa,
ONTARIO, K1Y4S1

TRADEMARK DETAILS

COOL OFFSET

Trademark Type

Word

Goods

Class 16

uncoated printing paper

Application Number 1,960,925
Language of Application English

Filing Date 2019-05-03

APPLICANT AND AGENT DETAILS

Applicant

S.C. Johnson & Son, Inc.
1525 Howe Street
Racine, WI 53403
UNITED STATES OF AMERICA

Agent

BERESKIN & PARR LLP/S.E.N.C.R.L., S.R.L.
SCOTIA PLAZA, 40 KING STREET WEST,
40th FLOOR, TORONTO, ONTARIO, M5H3Y2

TRADEMARK DETAILS

BRISE EXOTIQUE RELAXANTE

Trademark Type

Standard Characters

Goods

Class 03

(1) essential oils for aromatherapy; fragrance for household purposes; incense; potpourri; room fragrancing preparations; scented room sprays;

Class 04

(2) candles; perfumed candles;

Application Number 1,960,986
Language of Application English

Filing Date 2019-05-03

APPLICANT AND AGENT DETAILS

Applicant

Bath & Body Works Brand Management, Inc.
Seven Limited Parkway
Reynoldsburg, OH 43068
UNITED STATES OF AMERICA

Agent

BAKER & MCKENZIE LLP
BROOKFIELD PLACE, 181 BAY STREET,
SUITE 2100, P.O. BOX 874, TORONTO,
ONTARIO, M5J2T3

TRADEMARK DETAILS

MAHOGANY APPLE

Trademark Type

Standard Characters

Goods

Class 03

(1) Fragrance emitting wicks for room fragrance, room fragrance refills for electric and non-electric room fragrance dispensers, scented oils used to produce aromas when heated, scented room sprays, home fragrance oils.

Class 04

(2) Candles.

Application Number 1,961,233
Language of Application English

Filing Date 2019-05-06

APPLICANT AND AGENT DETAILS

Applicant

Sur Andino S.A.
Av. Apoquindo 3669, Piso 6
Las Condes, Santiago
CHILE

Agent

BLAKE, CASSELS & GRAYDON LLP
INTELLECTUAL PROPERTY GROUP, SUITE
4000, COMMERCE COURT WEST, 199 BAY
STREET, TORONTO, ONTARIO, M5L1A9

TRADEMARK DETAILS

LIMARINA

Trademark Type

Word

Goods

Class 33

wines and sparkling wines

Application Number 1,961,627
Language of Application English

Filing Date 2019-05-08

APPLICANT AND AGENT DETAILS

Applicant

Kamran Sheikh
Site 1, RR2
Station Main
P.O. Box 2
Cochrane
ALBERTA
T4C1A2

Agent

DENTONS CANADA LLP
2500 Stantec Tower, 10220-103 Avenue NW,
EDMONTON, ALBERTA, T5J0K4

TRADEMARK DETAILS

BREACH BAIT

Trademark Type

Word

Goods

Class 28

Fishing tackle, namely artificial fishing lures

Application Number 1,961,656
Language of Application English

Filing Date 2019-05-08

APPLICANT AND AGENT DETAILS

Applicant

Dalton Phillip Mazarura
12028 177 Ave NW
Edmonton
ALBERTA
T5X0K9

Agent

WITMART INC.
34 King Street East, Suite 500, Toronto,
ONTARIO, M5C2X8

TRADEMARK DETAILS

Trademark Type

Design

Visual Representation



Goods

Class 25

Blazers; Dresses; Hats; Hooded sweatshirts; Jackets; Jean; Pants; Shoes; Sweaters; T-shirts;
Dress shirts

Application Number 1,962,061
Language of Application English

Filing Date 2019-05-09

APPLICANT AND AGENT DETAILS

Applicant

Abbott Cardiovascular Systems Inc.
3200 Lakeside Drive
Santa Clara, CA 95054
UNITED STATES OF AMERICA

Agent

BAKER & MCKENZIE LLP
BROOKFIELD PLACE, 181 BAY STREET,
SUITE 2100, P.O. BOX 874, TORONTO,
ONTARIO, M5J2T3

TRADEMARK DETAILS

XIENCE SKYPOINT

Trademark Type

Word

Goods

Class 10

Surgical and medical apparatus and instruments, namely stents, drug-eluting stents; balloons, namely, medical balloons; catheters, balloon catheters, guide wires and introducer sheaths.

Claims

Priority Filing Date: May 08, 2019, Country or Office: UNITED STATES OF AMERICA, Application No: 88421411 in association with the same kind of goods

Application Number 1,962,464
Language of Application English

Filing Date 2019-05-13

APPLICANT AND AGENT DETAILS

Applicant

Dream Crew IP
5th Floor
10960 Wilshire Boulevard
90024 Los Angeles California
UNITED STATES OF AMERICA

Agent

MILTONS IP/P.I.
15 Fitzgerald Rd, Suite 200, Ottawa,
ONTARIO, K2H9G1

TRADEMARK DETAILS

MORE LIFE

Trademark Type

Word

Goods

Class 34

Cannabis for smoking; cannabis oil for oral vaporizers for smoking; derivatives of cannabis, namely resins and oils, for oral vaporizers for smoking; dried cannabis; electronic cigarette liquid (e-liquid) comprised of flavorings in liquid form containing cannabis; rolling papers for cannabis cigarettes; smokers' articles, namely, smoking pipes for use with marijuana and cannabis; tetrahydrocannabinol [THC] oil for oral vaporizers for smoking; vaping pens for smoking purposes containing cannabis;

Application Number 1,962,525
Language of Application English

Filing Date 2019-05-13

APPLICANT AND AGENT DETAILS

Applicant

Jimco Equipment Corporation
95 Edens Fork Road
Charleston, WV 25312
UNITED STATES OF AMERICA

Agent

GOWLING WLG (CANADA) LLP
SUITE 2600, 160 ELGIN STREET, OTTAWA,
ONTARIO, K1P1C3

TRADEMARK DETAILS

Trademark Type

Design

Visual Representation

The logo for JOHN HENRY features the words "JOHN" and "HENRY" in a bold, black, sans-serif font. A stylized key is positioned horizontally between the two words, with its head on the left and its shaft extending to the right, passing through the letter "H" in "HENRY".

Goods

Class 07

Rock drills and parts therefor; drill bits for rock drilling.

Services

Class 37

Repair and maintenance of rock drills.

Application Number 1,962,767
Language of Application English

Filing Date 2019-05-14

APPLICANT AND AGENT DETAILS

Applicant

ProSlide Technology Inc.
2650 Queensview Drive, Suite 150
Ottawa
ONTARIO
K2B8H6

Agent

SMART & BIGGAR LLP
SUITE 900, 55 METCALFE STREET, P.O.
BOX 2999, STATION D, OTTAWA, ONTARIO,
K1P5Y6

TRADEMARK DETAILS

PIPElineBLAST

Trademark Type

Word

Goods

Class 28

Amusement park rides; amusement park water rides; water slides;

Application Number 1,963,225
Language of Application English

Filing Date 2019-05-15

APPLICANT DETAILS

Applicant
10991287 CANADA INC.
772 College St
Toronto
ONTARIO
M6G1C6

TRADEMARK DETAILS

RONTO'S

Trademark Type
Word

Services

Class 35

(1) Providing technical assistance in the establishment and operation of restaurant franchises

Class 43

(2) Restaurant services; Catering services

Application Number 1,963,757
Language of Application English

Filing Date 2019-05-17

APPLICANT AND AGENT DETAILS

Applicant

FGX International Inc.
500 George Washington Highway
Smithfield, RI 02917
UNITED STATES OF AMERICA

Agent

RIDOUT & MAYBEE LLP
11 Holland Avenue, Suite 601 , Ottawa,
ONTARIO, K1Y4S1

TRADEMARK DETAILS

STREETTECH

Trademark Type

Standard Characters

Goods

Class 09

lenses, namely anti-reflective lenses, polarized lenses for eyeglasses, anti-fog lenses for eyeglasses, eyewear, namely spectacles, eyeglasses, reading glasses, sunglasses, lenses, contact lenses, eyeglass lenses, eyeglass frames, optical frames, and accessories related thereto.

Claims

Priority Filing Date: May 16, 2019, Country or Office: UNITED STATES OF AMERICA, Application No: 88432999 in association with the same kind of goods

Application Number 1,963,788
Language of Application English

Filing Date 2019-05-17

APPLICANT AND AGENT DETAILS

Applicant

Medicom Healthcare Limited
235 Hunts Pond Road
Titchfield Common
Fareham, Hampshire PO14 4PJ
UNITED KINGDOM

Agent

NORTON ROSE FULBRIGHT CANADA LLP/S.
E.N.C.R.L.,S.R.L.
1800 - 510 West Georgia Street, Vancouver,
BRITISH COLUMBIA, V6B0M3

TRADEMARK DETAILS

REMOS

Trademark Type

Word

Goods

Class 05

(1) Pharmaceutical preparations for the treatment of eye diseases and conditions; ophthalmic preparations; eye drops; eye gels for medical use; eye gels for ophthalmic use; eye ointments for medical use; eye ointments for ophthalmic use; eye wipes for medical use; eye wipes for ophthalmic use; eye care pharmaceutical products for medical use for the treatment of eye diseases and conditions; eye care products for ophthalmic use in the treatment of eye diseases and conditions; vitamin and mineral food supplements; solutions for contact lenses / solutions for use with contact lenses; contact lens cleaning preparations (cleaning, wetting, disinfectants); eyepatches for medical purposes; medicated eye-washes; astringents for medical purposes; tissues impregnated with pharmaceutical lotions for the treatment of eye diseases and conditions; thermal eye compresses

Class 10

(2) Apparatus for administering preparations to the eye for the treatment of eye diseases and conditions; medical devices for administering preparations to the eye for the treatment of eye diseases and conditions; apparatus and medical devices for administering preparations to the eye for the treatment of eye diseases and conditions; apparatus for administering preparations to the eye for the treatment of eye diseases and conditions; eye testing machines; ophthalmoscopes; optometric instruments; artificial lenses for implantation in the eye; eye baths; eye droppers for medical use for the treatment of eye diseases and conditions; eye shields for surgical use / medical use; and eye pads for surgical use

Claims

Priority Filing Date: November 19, 2018, Country or Office: EUIPO (EU), Application No: 017987004 in association with the same kind of goods

Application Number 1,964,053
Language of Application English

Filing Date 2019-05-21

APPLICANT AND AGENT DETAILS

Applicant

Marine Canada Acquisition Inc.
3831 No. 6 Rd
Richmond
BRITISH COLUMBIA
V6V1P6

Agent

SMART & BIGGAR LLP
2300 - 1055 West Georgia Street, P.O. Box
11115, Vancouver, BRITISH COLUMBIA,
V6E3P3

TRADEMARK DETAILS

PROHEAT

Trademark Type

Word

Goods

Class 11

Heaters for vehicles and parts and accessories therefor

Application Number 1,964,652
Language of Application English

Filing Date 2019-05-24

APPLICANT AND AGENT DETAILS

Applicant

IGT, a legal entity
9295 Prototype Drive
Reno, NV 89521
UNITED STATES OF AMERICA

Agent

COLLEEN CAISSIE-DUPUIS
(c/o IGT Canada Solutions ULC), 328 Urquhart
Avenue, Moncton, NEW BRUNSWICK,
E1H2R6

TRADEMARK DETAILS

WU DA JIANG

Trademark Type

Word

Foreign Character Translation

As provided by the applicant, the translation is FIVE BIG PRIZES/5 BIG S AWARDS

Goods

Class 28

Gaming machines, namely, devices which accept a wager; Reconfigurable casino and lottery gaming equipment, namely, gaming machines; lottery tickets; lottery cards; scratch cards for playing lottery games

Application Number 1,964,716
Language of Application English

Filing Date 2019-05-24

APPLICANT AND AGENT DETAILS

Applicant

PUTTING EDGE ENTERTAINMENT
CORPORATION
2000 Argentia Road
Plaza 4, Suite 340
Mississauga
ONTARIO
L5N1W1

Agent

MILLER IP LAW
84 Neilson Drive, Toronto, ONTARIO, M9C1V7

TRADEMARK DETAILS

ILLUMINATED PLAY

Trademark Type

Word

Services

Class 41

Entertainment services, namely providing glow in the dark miniature golf courses; amusement arcade services

Application Number 1,964,717
Language of Application English

Filing Date 2019-05-24

APPLICANT AND AGENT DETAILS

Applicant

EuroChem Trading GmbH
Baarerstr. 37
6300 Zug
SWITZERLAND

Agent

BERESKIN & PARR LLP/S.E.N.C.R.L., S.R.L.
SCOTIA PLAZA, 40 KING STREET WEST,
40th FLOOR, TORONTO, ONTARIO, M5H3Y2

TRADEMARK DETAILS

Trademark Type

Design

Visual Representation



Colour Claim

Colour is claimed as a feature of the trade-mark. The pod design is orange with the stylized 'U' and 'S' in white, the letters 'stimul' are in blue, and the letters 'US' are in orange.

Goods

Class 01

chemicals used in agriculture, horticulture and forestry; fertilizers, chemical products for fertilizers

Application Number 1,964,761
Language of Application English

Filing Date 2019-05-24

APPLICANT AND AGENT DETAILS

Applicant

Société des Produits Nestlé, S.A.
Case Postale 353
Vevey 1800
SWITZERLAND

Agent

BORDEN LADNER GERVAIS LLP
World Exchange Plaza, 100 Queen Street,
Suite 1300, Ottawa, ONTARIO, K1P1J9

TRADEMARK DETAILS

Trademark Type

Design

Visual Representation



Colour Claim

Colour is claimed as a feature of the trademark. The box around the entire trademark is set out in orange with an inner black filled box containing the words 'overweight management' in white. The letters 'OM' are set out in white against an orange filled background and the words 'select blend' are set out in black within a white filled box with an orange contour to the left of images of nuggets of food shown in light brown, in part against the white filled box and touching the orange background and the black filled box.

Goods

Class 31

Food for animals, namely, food for pets

Application Number 1,964,819
Language of Application English

Filing Date 2019-05-24

APPLICANT AND AGENT DETAILS

Applicant

Norske Skog AS
Karenslyst allé 49
0279 Oslo
NORWAY

Agent

ROBIC
630, boul. René-Lévesque Ouest, 20e étage,
Montréal, QUEBEC, H3B1S6

TRADEMARK DETAILS

Trademark Type

Design

Visual Representation



Colour Claim

Colour is claimed as a feature of the trademark. The colors green and blue are claimed as a feature of the mark. The trademark consists of the design of opposing branches in green, the term "NOR" and a vertical line in blue.

Goods

Class 16

Cardboard, paper, printing paper, magazine paper.

Claims

Priority Filing Date: February 11, 2019, Country or Office: NORWAY, Application No: 201901933 in association with the same kind of goods

Application Number 1,964,836
Language of Application English

Filing Date 2019-05-24

APPLICANT AND AGENT DETAILS

Applicant

Project Clean Inc.
250-69 John St. South
Hamilton,
ONTARIO
L8N2B9

Agent

LAWSON LUNDELL LLP
1600 CATHEDRAL PLACE, 925 WEST
GEORGIA STREET, VANCOUVER, BRITISH
COLUMBIA, V6C3L2

TRADEMARK DETAILS

MAXIM

Trademark Type

Standard Characters

Goods

Class 03

(1) environmentally friendly cleaning preparations for janitorial use, namely, all-purpose cleaning preparations, window spray cleaning preparations, bath cleaning preparations, kitchen and bath spray, and kitchen and bath scouring preparations, namely, scouring liquids and scouring powders; general purpose heavy duty cleaner, primarily for janitorial and institutional use; dishwasher detergent; dishwasher rinse agent; dishwasher cleaning preparations, namely, dishwasher sanitizer; dishwasher drying agent; furniture and glass cleaning and polishing preparations; stainless steel cleaning preparations; floor and bathroom tile cleaning preparations; hardwood cleaning preparations; warewash and laundry soaps and detergents; hand soaps and hand lotions for use in commercial, industrial and institutional settings; carpet cleaning solutions and stain removers; cleaning preparations for use on fabrics, upholstery and carpets, with and without deodorant properties;

Class 05

(2) industrial and janitorial cleaning supplies, namely degreasing, polishing and finishing preparations and cleaning preparations with disinfecting properties for use on inanimate surfaces, namely, floor cleaning preparations, floor polishing preparations, floor finishing preparations, floor wax and polish removing preparations; disinfectant sprays and liquids;

Class 09

(3) downloadable digital videos containing information concerning chemistry and the environment, all in relation to natural products for cleaning and sanitation purposes;

Class 16

(4) printed materials, namely booklets, pamphlets, brochures and educational knowledge tests containing information concerning chemistry and the environment, all in relation to natural products for cleaning and sanitation purposes;

Class 21

(5) dispensing units for cleaning preparations for janitorial use, namely, all-purpose cleaning preparations, window spray cleaning preparations, bath cleaning preparations, kitchen and bath spray, and kitchen and bath scouring preparations, disinfectant sprays and liquids, general purpose heavy duty cleaner, primarily for janitorial and institutional use

Services**Class 41**

providing online materials, namely non-downloadable booklets, pamphlets and brochures, educational knowledge tests and non-downloadable videos containing information concerning chemistry and the environment all in relation to natural products for cleaning and sanitation purposes;

Application Number 1,964,902
Language of Application English

Filing Date 2019-05-27

APPLICANT AND AGENT DETAILS

Applicant

Stay Wyld Organics, Ltd.
1911 Highway 99
Pemberton
BRITISH COLUMBIA
V0N2L0

Agent

ANITA MAR
dba Trademark Angel , Suite 521, 6-2557
Dougall Avenue, Windsor, ONTARIO, N8X1T5

TRADEMARK DETAILS

STAY WYLD

Trademark Type

Word

Goods

Class 05

(1) herbal supplements for general health and well-being; mineral supplements; protein powders for meal replacement for use as a dietary supplement; soy protein dietary supplements; tincture of iodine; vitamin preparations in the form of meal replacement drinks and powders; vitamin supplements

Class 29

(2) dried edible mushrooms; dried fruit mixes; dried mushrooms; jerky; mushrooms puree; nut-based snack mixes; protein for use as a food additive; sausages; soup mixes; vegetarian sausages; veggie burger patties

Class 30

(3) granola-based snack bars; granola-based snack food; sandwiches; sausage rolls;

Application Number 1,965,044
Language of Application English

Filing Date 2019-05-27

APPLICANT AND AGENT DETAILS

Applicant

C. B. Fleet Company, Incorporated
4615 Murray Place
Lynchburg, VA 24502
UNITED STATES OF AMERICA

Agent

WILSON LUE LLP
250 University Avenue, 5th Floor, Toronto,
ONTARIO, M5H3E5

TRADEMARK DETAILS

SUNSET OASIS

Trademark Type

Word

Goods

Class 03

Cloths or tissues impregnated with a skin cleanser; feminine deodorant sprays; feminine hygiene cleansing towelettes; non-medicated cleaning preparations for use on the body; non-medicated feminine hygiene wash; pre-moistened cosmetic towelettes; shower and bath foam;

Application Number 1,965,325
Language of Application English

Filing Date 2019-05-28

APPLICANT AND AGENT DETAILS

Applicant

SHARKNINJA OPERATING LLC
89 A Street, Suite 100
Needham, MA 02494
UNITED STATES OF AMERICA

Agent

MBM INTELLECTUAL PROPERTY LAW LLP
275 SLATER STREET, 14TH FLOOR,
OTTAWA, ONTARIO, K1P5H9

TRADEMARK DETAILS

ULTRA PREP

Trademark Type

Word

Goods

Class 07

Electric kitchen appliances for household use, namely, electric food blenders, electric food choppers and electric food processors, electric mixers, electric food and meat grinders, electric coffee grinders, electric juicers, electric juice extractors, electric food slicers, electric graters

Application Number 1,965,341
Language of Application English

Filing Date 2019-05-28

APPLICANT AND AGENT DETAILS

Applicant

Skullcandy, Inc.
6301 N. Landmark Dr.
Park City, UT 84098
UNITED STATES OF AMERICA

Agent

BENNETT JONES LLP
3200 TELUS HOUSE, SOUTH TOWER, 10020
- 100TH STREET, EDMONTON, ALBERTA,
T5J0N3

TRADEMARK DETAILS

TRULY WIRELESS. PERFECTLY SIMPLE

Trademark Type

Word

Goods

Class 09

Headphones, earphones, earbuds

Application Number 1,965,344
Language of Application English

Filing Date 2019-05-28

APPLICANT AND AGENT DETAILS

Applicant

Sunseeker U.S. Inc.
1402 Waxhaw-Indian Trail Road
Indian Trail, NC 28079
UNITED STATES OF AMERICA

Agent

RIDOUT & MAYBEE LLP
250 University Avenue, 5th Floor, Toronto,
ONTARIO, M5H3E5

TRADEMARK DETAILS

WILD BADGER POWER

Trademark Type

Word

Goods

Class 07

Power-operated brush cutters

Application Number 1,965,379
Language of Application English

Filing Date 2019-05-28

APPLICANT AND AGENT DETAILS

Applicant

MELISSA & DOUG, LLC
141 Danbury Road
Wilton, CT 06897
UNITED STATES OF AMERICA

Agent

MILLER IP LAW
84 Neilson Drive, Toronto, ONTARIO, M9C1V7

TRADEMARK DETAILS

Trademark Type

Design

Visual Representation



Goods

Class 28

Role playing toys in the nature of play sets for children to imitate real life occupations

Claims

Priority Filing Date: November 29, 2018, Country or Office: UNITED STATES OF AMERICA,
Application No: 88/210,760 in association with the same kind of goods

Application Number 1,965,525
Language of Application English

Filing Date 2019-05-29

APPLICANT AND AGENT DETAILS

Applicant

Iterum Therapeutics International Limited
Block 2, Floor 3 Harcourt Centre
Harcourt Street
Dublin 2
IRELAND

Agent

GILBERT'S LLP
77 King St W, Suite 2010, P.O. Box 301,
Toronto-Dominion Centre, Toronto, ONTARIO,
M5K1K2

TRADEMARK DETAILS

ORVALIA

Trademark Type

Word

Goods

Class 05

Pharmaceutical preparations, namely antibiotics

Application Number 1,965,564
Language of Application English

Filing Date 2019-05-29

APPLICANT AND AGENT DETAILS

Applicant

Medline Industries, LP
Three Lakes Drive
Northfield, IL 60093
UNITED STATES OF AMERICA

Agent

DEETH WILLIAMS WALL LLP
150 YORK STREET, SUITE 400, TORONTO,
ONTARIO, M5H3S5

TRADEMARK DETAILS

Trademark Type

Design

Visual Representation



Goods

Class 05

(1) Medical preparations for tissue regeneration

Class 10

(2) Medical apparatus to assist in tissue regeneration

Class 16

(3) Printed material, namely, manuals, information sheets and newsletters in the field of tissue regeneration

Services

Class 41

Educational services, namely, providing courses in the field of tissue regeneration

Application Number 1,965,614
Language of Application English

Filing Date 2019-05-29

APPLICANT AND AGENT DETAILS

Applicant

AGS LLC
6775 S. Edmond St.
Suite 300
Las Vegas, NV 89118
UNITED STATES OF AMERICA

Agent

SMART & BIGGAR LLP
SUITE 900, 55 METCALFE STREET, P.O.
BOX 2999, STATION D, OTTAWA, ONTARIO,
K1P5Y6

TRADEMARK DETAILS

Trademark Type

Design

Visual Representation



Goods

Class 09

(1) recorded computer software for games of chance on a computerized platform, namely, video based slot machines

Class 28

(2) gaming machines, namely, devices which accept a wager

Application Number 1,965,616
Language of Application English

Filing Date 2019-05-29

APPLICANT AND AGENT DETAILS

Applicant

AGS LLC
6775 S. Edmond St.
Suite 300
Las Vegas, NV 89118
UNITED STATES OF AMERICA

Agent

SMART & BIGGAR LLP
SUITE 900, 55 METCALFE STREET, P.O.
BOX 2999, STATION D, OTTAWA, ONTARIO,
K1P5Y6

TRADEMARK DETAILS

XTREME JACKPOTS

Trademark Type

Word

Goods

Class 09

(1) recorded computer software for games of chance on a computerized platform, namely, video based slot machines

Class 28

(2) gaming machines, namely, devices which accept a wager

Application Number 1,965,617
Language of Application English

Filing Date 2019-05-29

APPLICANT AND AGENT DETAILS

Applicant

AGS LLC
6775 S. Edmond St.
Suite 300
Las Vegas, NV 89118
UNITED STATES OF AMERICA

Agent

SMART & BIGGAR LLP
SUITE 900, 55 METCALFE STREET, P.O.
BOX 2999, STATION D, OTTAWA, ONTARIO,
K1P5Y6

TRADEMARK DETAILS

SHADOW FOX DREAM CATCHER

Trademark Type

Word

Goods

Class 09

(1) recorded computer software for games of chance on a computerized platform, namely, video based slot machines

Class 28

(2) gaming machines, namely, devices which accept a wager

Application Number 1,965,623
Language of Application English

Filing Date 2019-05-29

APPLICANT AND AGENT DETAILS

Applicant

Double Shot Equity, LLC
80 Pegan Lane
Dover, MA 02030
UNITED STATES OF AMERICA

Agent

RIDOUT & MAYBEE LLP
250 University Avenue, 5th Floor, Toronto,
ONTARIO, M5H3E5

TRADEMARK DETAILS

Trademark Type

Design

Visual Representation



Services

Class 43

Restaurant, pizza parlor, bar, cafe and catering services

Application Number 1,965,625
Language of Application English

Filing Date 2019-05-29

APPLICANT AND AGENT DETAILS

Applicant

Double Shot Equity, LLC
80 Pegan Lane
Dover, MA 02030
UNITED STATES OF AMERICA

Agent

RIDOUT & MAYBEE LLP
250 University Avenue, 5th Floor, Toronto,
ONTARIO, M5H3E5

TRADEMARK DETAILS

TWO BOOTS

Trademark Type

Word

Services

Class 43

Restaurant, pizza parlor, bar, cafe and catering services

Application Number 1,965,732
Language of Application English

Filing Date 2019-05-29

APPLICANT AND AGENT DETAILS

Applicant

Abbott of England 1981 Ltd.
545 Trethewey Drive
Toronto
ONTARIO
M6M2J4

Agent

NADINE D'AGUIAR
Simpson Tower, 401 Bay Street, Suite 2100,
Mailbox #55, Toronto, ONTARIO, M5H2Y4

TRADEMARK DETAILS

ABBOTT COLLECTION

Trademark Type

Word

Goods

Class 04

(1) candles; perfumed candles; scented candles; tapers; tealight candles; tealights

Class 06

(2) door stops of metal; drawer pulls of metal; figurines of common metal; metal clothes hooks; metal knobs; metal knockers; plant hangers of metal; pot hooks of metal; shelf brackets of metal

Class 08

(3) butter knives; cake cutters; cake forks; cheese knives; coffee spoons; cutlery; fire pokers; gardening scissors; spoons for tea

Class 11

(4) fairy lights for festive decoration; flameless candles; lanterns; lighting fixtures; string lights for festive decoration; table lamps

Class 14

(5) bangle bracelets; bangles; bracelets; charms for jewellery; clocks; costume jewellery; earrings; finger rings; jewel boxes; jewellery; jewellery boxes; jewellery bracelets; jewellery chains; jewellery charms; jewellery made of crystal; jewellery made of glass; jewelry; jewelry dishes; necklaces; rings being jewellery

Class 16

(6) paper napkins; paper place mats; place cards; postcards and greeting cards; table napkins of paper

Class 18

(7) beach bags; cosmetic bags; fake fur; faux fur; grocery tote bags; parasols; shoulder bags; souvenir bags; sun umbrellas; tote bags; umbrellas

Class 19

(8) figurines of concrete; figurines of marble; figurines of stone

Class 20

(9) bar stools; bathroom and shaving mirrors; beds for household pets; bottle racks; decorative pillows; end tables; garden furniture; mirrors; picture frames; resin figurines; sea shells; side tables; umbrella stands; wind chimes

Class 21

(10) beer glasses; beer mugs; beverage glassware; biodegradable bowls; biodegradable cups; biodegradable trays; bird feeders; boot jacks; bottle openers; bottle stands; bowls; boxes of glass; butter dishes; candle holders; candlesticks; candlesticks of glass; candlesticks with wind protection; candy boxes; canister sets; ceramic mugs; champagne buckets; champagne flutes; cheese boards; china ornaments; chopping boards for kitchen use; cleaning cloth; cleaning, dusting and polishing cloths; cloths for cleaning; cocktail glasses; cocktail picks; cocktail stirrers; coffee cups; coffee mugs; cork screws; corkscrews; crystal ornaments; cups and mugs; decanters; decorative glass; decorative plates; dinnerware; dishes; dishes for soap; dispensers for liquid soap for household purposes; drinking cups; drinking glasses; drinking straws; egg cups; flower pots; flower vases; flower vases and bowls; flower-pot covers; food storage containers; gift baskets sold empty; glass bowls; glass carafes; glass dishes; glass jars; goblets; gravy boats; ice tongs; kitchen enamelware; mugs; napkin holders and napkin rings; napkin rings; non-electric coffee pots; oil bottles; painted glassware; paper towel holders; pepper pots, sugar bowls and salt shakers; pet bowls; plates; pressed glass; salad bowls; salad servers; salt and pepper shakers; serving dishes; serving tongs; serving trays; soap dishes; straws for drinking; table glassware; table napkin holders; table plates; tea bag rests; tea cups; teapots; tissue boxes; tongs for ice; travel mugs; trivets; tumbler drinking glasses; vacuum bottles; vases; watering cans; wine glasses

Class 24

(11) afghans; baby blankets; banners of textile; bed and table linen; blanket throws; blankets for babies; cloth towels; decorative wall hangings of textile; dish cloths; dish towels for drying; fabric place mats; fabric table runners; felt and non-woven textile fabrics; place mats of textile; tea towels; throws

Class 26

(12) artificial Christmas garlands; artificial Christmas garlands incorporating lights; artificial Christmas wreaths; artificial Christmas wreaths incorporating lights; artificial flower arrangements; artificial flower wreaths; artificial flowers; artificial garlands; artificial garlands and wreaths; artificial plants; artificial topiaries; artificial wreaths

Class 27

(13) door mats; door mats of India rubber; doormats

Class 28

(14) Christmas decorations; Christmas ornaments; Christmas stockings; Christmas tree decorations; Christmas tree decorations and ornaments; Christmas tree ornaments; Christmas tree ornaments and decorations; Christmas tree skirts; Christmas trees of synthetic material; decorations and ornaments for Christmas trees; decorations for Christmas trees; ornaments and decorations for Christmas trees

Services**Class 35**

(1) online sales of arts and crafts; online sales of housewares; wholesale store services featuring cookware; wholesale store services featuring cutlery

(2) wholesale store services featuring candles, figurines of common metal, door stops, drawer pulls, clothes hooks, knobs, metal knockers, plant hangers, pot hooks, shelf brackets, butter knives, cake cutters, cake forks, cheese knives, coffee spoons, cutlery, fire pokers, gardening scissors, spoons for tea, fairy lights for festive decoration, flameless candles, lanterns, lighting fixtures, string lights for festive decoration, table lamps, bangle bracelets, bangles, bracelets, charms for jewellery, clocks, costume jewellery, earrings, finger rings, jewel boxes, jewellery, jewellery boxes, jewellery bracelets, jewellery chains, jewellery charms, jewellery made of crystal, jewellery made of glass, jewelry, jewelry dishes, necklaces, rings being jewellery, paper napkins, paper place mats, place cards, postcards and greeting cards, table napkins of paper, beach bags, cosmetic bags, fake fur, faux fur, grocery tote bags, parasols, shoulder bags, souvenir bags, sun umbrellas, tote bags, umbrellas, bar stools, bathroom and shaving mirrors, beds for household pets, bottle racks, decorative pillows, end tables, garden furniture, mirrors, picture frames, resin figurines, sea shells, side tables, umbrella stands, wind chimes, beer glasses, beer mugs, beverage glassware, biodegradable bowls, biodegradable cups, biodegradable trays, bird feeders, boot jacks, bottle openers, bottle stands, bowls, boxes of glass, butter dishes, candle holders, candlesticks, candlesticks of glass, candlesticks with wind protection, candy boxes, canister sets, ceramic mugs, champagne buckets, champagne flutes, cheese boards, china ornaments, chopping boards for kitchen use, cleaning cloth, cleaning, dusting and polishing cloths, cloths for cleaning, cocktail glasses, cocktail picks, cocktail stirrers, coffee cups, coffee mugs, cork screws, corkscrews, crystal ornaments, cups and mugs, decanters, decorative glass, decorative plates, dinnerware, dishes, dishes for soap, dispensers for liquid soap for household purposes, drinking cups, drinking glasses, drinking straws, egg cups, flower pots, flower vases, flower vases and bowls, flower-pot covers, food storage containers, gift baskets sold empty, glass bowls, glass carafes, glass dishes, glass jars, goblets, gravy boats, ice tongs, kitchen enamelware, mugs, napkin holders and napkin rings, napkin rings, non-electric coffee pots, oil bottles, painted glassware, paper towel holders, pepper pots, sugar bowls and salt shakers, pet bowls, plates, pressed glass, salad bowls, salad servers, salt and pepper shakers, serving dishes, serving tongs, serving trays, soap dishes, straws for drinking, table glassware, table napkin holders, table plates, tea bag rests, tea cups, teapots, tissue boxes, tongs for ice, travel mugs, trivets, tumbler drinking glasses, vacuum bottles, vases, watering cans, wine glasses, afghans, baby blankets, banners of textile, bed and table linen, blanket throws, blankets for babies, cloth towels, decorative wall hangings of textile, dish cloths, dish towels for drying, fabric place mats, fabric table runners, felt and non-woven textile fabrics, place mats of textile, tea towels, throws, artificial Christmas garlands, artificial Christmas garlands incorporating lights, artificial Christmas wreaths, artificial Christmas wreaths incorporating lights, artificial flower arrangements, artificial flower wreaths, artificial flowers, artificial garlands, artificial garlands and wreaths, artificial plants, artificial topiaries, artificial wreaths, door mats, door mats of India rubber, doormats, Christmas decorations, Christmas ornaments, Christmas stockings, Christmas tree decorations, Christmas tree decorations and ornaments, Christmas tree ornaments, Christmas tree ornaments and decorations, Christmas tree skirts, Christmas trees of synthetic material, decorations and ornaments for Christmas trees, decorations for Christmas trees, ornaments and decorations for Christmas trees, figurines of concrete, figurines of marble, and figurines of stone; online sales of candles, figurines, door stops, drawer pulls, clothes hooks, knobs, knockers, plant hangers, pot hooks, shelf brackets, butter knives, cake cutters, cake forks, cheese knives, coffee spoons, cutlery, fire pokers, gardening scissors, spoons for tea, fairy lights for festive decoration, flameless candles, lanterns, lighting fixtures, string lights for festive decoration, table lamps, bangle bracelets, bangles, bracelets, charms for jewellery, clocks, costume jewellery, earrings, finger rings, jewel boxes, jewellery, jewellery boxes, jewellery bracelets, jewellery chains, jewellery charms, jewellery made of crystal, jewellery made of glass, jewelry, jewelry dishes, necklaces,

rings being jewellery, paper napkins, paper place mats, place cards, postcards and greeting cards, table napkins of paper, beach bags, cosmetic bags, fake fur, faux fur, grocery tote bags, parasols, shoulder bags, souvenir bags, sun umbrellas, tote bags, umbrellas, bar stools, bathroom and shaving mirrors, beds for household pets, bottle racks, decorative pillows, end tables, garden furniture, mirrors, picture frames, resin figurines, sea shells, side tables, umbrella stands, wind chimes, beer glasses, beer mugs, beverage glassware, biodegradable bowls, biodegradable cups, biodegradable trays, bird feeders, boot jacks, bottle openers, bottle stands, bowls, boxes of glass, butter dishes, candle holders, candlesticks, candlesticks of glass, candlesticks with wind protection, candy boxes, canister sets, ceramic mugs, champagne buckets, champagne flutes, cheese boards, china ornaments, chopping boards for kitchen use, cleaning cloth, cleaning, dusting and polishing cloths, cloths for cleaning, cocktail glasses, cocktail picks, cocktail stirrers, coffee cups, coffee mugs, cork screws, corkscrews, crystal ornaments, cups and mugs, decanters, decorative glass, decorative plates, dinnerware, dishes, dishes for soap, dispensers for liquid soap for household purposes, drinking cups, drinking glasses, drinking straws, egg cups, flower pots, flower vases, flower vases and bowls, flower-pot covers, food storage containers, gift baskets sold empty, glass bowls, glass carafes, glass dishes, glass jars, goblets, gravy boats, ice tongs, kitchen enamelware, mugs, napkin holders and napkin rings, napkin rings, non-electric coffee pots, oil bottles, painted glassware, paper towel holders, pepper pots, sugar bowls and salt shakers, pet bowls, plates, pressed glass, salad bowls, salad servers, salt and pepper shakers, serving dishes, serving tongs, serving trays, soap dishes, straws for drinking, table glassware, table napkin holders, table plates, tea bag rests, tea cups, teapots, tissue boxes, tongs for ice, travel mugs, trivets, tumbler drinking glasses, vacuum bottles, vases, watering cans, wine glasses, afghans, baby blankets, banners of textile, bed and table linen, blanket throws, blankets for babies, cloth towels, decorative wall hangings of textile, dish cloths, dish towels for drying, fabric place mats, fabric table runners, felt and non-woven textile fabrics, place mats of textile, tea towels, throws, artificial Christmas garlands, artificial Christmas garlands incorporating lights, artificial Christmas wreaths, artificial Christmas wreaths incorporating lights, artificial flower arrangements, artificial flower wreaths, artificial flowers, artificial garlands, artificial garlands and wreaths, artificial plants, artificial topiaries, artificial wreaths, door mats, door mats of India rubber, doormats, Christmas decorations, Christmas ornaments, Christmas stockings, Christmas tree decorations, Christmas tree decorations and ornaments, Christmas tree ornaments, Christmas tree ornaments and decorations, Christmas tree skirts, Christmas trees of synthetic material, decorations and ornaments for Christmas trees, decorations for Christmas trees, ornaments and decorations for Christmas trees, figurines of concrete, figurines of marble and figurines of stone

Application Number 1,965,920
Language of Application English

Filing Date 2019-05-30

APPLICANT AND AGENT DETAILS

Applicant

Shield TX (UK) Limited
Northern Design Centre
Baltic Business Quarter
Gateshead, Tyne and Wear, NE8 3DF
UNITED KINGDOM

Agent

GOWLING WLG (CANADA) LLP
SUITE 1600, 1 FIRST CANADIAN PLACE, 100
KING STREET WEST, TORONTO, ONTARIO,
M5X1G5

TRADEMARK DETAILS

ACCRUFER

Trademark Type

Standard Characters

Goods

Class 05

Dietary supplements consisting primarily of iron; dietary supplements for animals for the prevention and treatment of iron deficiency and anaemia in animals; dietary supplements for humans for the prevention and treatment of iron deficiency and anaemia in humans; dietetic food and substances adapted for medical use for the prevention and treatment of iron deficiency and anaemia in humans; dietetic food and substances adapted for veterinary use for the prevention and treatment of iron deficiency and anaemia in animals; nutritional supplements consisting primarily of iron; pharmaceutical preparations for the prevention and treatment of iron deficiency and anaemia in humans; veterinary pharmaceutical preparations for the prevention and treatment of iron deficiency and anaemia in animals;

Claims

Priority Filing Date: November 30, 2018, Country or Office: UNITED KINGDOM, Application No: 3357629 in association with the same kind of goods

Application Number 1,966,621
Language of Application English

Filing Date 2019-06-03

APPLICANT AND AGENT DETAILS

Applicant

F&I Energy AG
Baarerstrasse 52
6300
Zug
SWITZERLAND

Agent

BENOÎT & CÔTÉ INC.
560 boul. Crémazie Est, 3e étage, Montréal,
QUEBEC, H2P1E8

TRADEMARK DETAILS

Trademark Type
Design

Visual Representation



Goods

Class 33

alcoholic cocktails; alcoholic energy drinks; alcoholic fruit beverages; brandy; fruit liqueurs; gin; rum; rum-based beverages; vodka; vodka cocktails; whiskey; wine

Application Number 1,966,671
Language of Application English

Filing Date 2019-06-04

APPLICANT AND AGENT DETAILS

Applicant

Dongguan Yihi Electronic Co., Ltd.
F-330 Commercial Office Building, Third Floor
of the Southern Exhibition Center
the side of Dongguan & Shenzhen Highway,
Zhangmutou Town, Dongguan City, 523620
CHINA

Agent

NEOMARK LTD.
7450 rue Saint-Hubert, Montréal, QUEBEC,
H2R2N3

TRADEMARK DETAILS

Trademark Type

Design

Visual Representation



Goods

Class 09

(1) Electronic chips for the manufacture of integrated circuits; blank smart cards; telephone smart cards; batteries for electronic cigars; battery chargers for electronic cigarettes; electric storage batteries; chargers for electronic cigarettes; batteries for electronic cigarettes; electronic components for integrated circuit cards.

Class 34

(2) Electronic cigarettes; liquid solutions for use in electronic cigarettes; electronic cigarettes for use as an alternative to traditional cigarettes; herbs for use as tobacco substitutes; cigarettes; herbal molasses as a tobacco substitute; electronic smoking pipes; smokeless cigarette vaporizer pipes; oral vaporizers for smokers; cases for electronic cigarettes; cigarette cases.

Application Number 1,966,706
Language of Application English

Filing Date 2019-06-04

APPLICANT AND AGENT DETAILS

Applicant

MN Inter-Fashion Ltd.
1-2-7, Moto Akasaka, Minato-ku
Tokyo,
JAPAN

Agent

OSLER, HOSKIN & HARCOURT LLP
SUITE 1900, 340 ALBERT STREET,
OTTAWA, ONTARIO, K1R7Y6

TRADEMARK DETAILS

SHIELD

Trademark Type

Word

Goods

Class 24

(1) Textile piece goods, namely fabric for use in the manufacture of articles of clothing and sleeping bags.

(2) Woven fabrics, knitted fabrics, felt and non-woven textile fabrics, cloth labels.

Class 25

(3) Clothing, namely, coats, jackets, trousers, anoraks, hoods and hooded robes, hats, footwear, namely, shoes, sandals and boots, belts for clothing.

Application Number 1,966,726
Language of Application English

Filing Date 2019-06-04

APPLICANT AND AGENT DETAILS

Applicant

Pursuit Aviation, LLC
1375 Enclave Parkway
Houston, TX 77077
UNITED STATES OF AMERICA

Agent

ROBIC
630, boul. René-Lévesque Ouest, 20e étage,
Montréal, QUEBEC, H3B1S6

TRADEMARK DETAILS

JETCAM

Trademark Type

Word

Services

Class 41

Aerial cinematography services; aerial photography

Claims

Priority Filing Date: December 14, 2018, Country or Office: UNITED STATES OF AMERICA,
Application No: 88/230,258 in association with the same kind of services

Application Number 1,966,727
Language of Application English

Filing Date 2019-06-04

APPLICANT AND AGENT DETAILS

Applicant

Pursuit Aviation, LLC
1375 Enclave Parkway
Houston, TX 77077
UNITED STATES OF AMERICA

Agent

ROBIC
630, boul. René-Lévesque Ouest, 20e étage,
Montréal, QUEBEC, H3B1S6

TRADEMARK DETAILS

Trademark Type

Design

Visual Representation



Services

Class 41

Aerial cinematography services; aerial photography

Claims

Priority Filing Date: December 14, 2018, Country or Office: UNITED STATES OF AMERICA,
Application No: 88/230,242 in association with the same kind of services

Application Number 1,967,089
Language of Application English

Filing Date 2019-06-05

APPLICANT AND AGENT DETAILS

Applicant

SELMARK, S.L.
PTL Valladares, Calle C - Nave A-11
36215 Vigo (Pontevedra)
SPAIN

Agent

GOWLING WLG (CANADA) LLP
SUITE 2600, 160 ELGIN STREET, OTTAWA,
ONTARIO, K1P1C3

TRADEMARK DETAILS

Trademark Type

Design

Visual Representation



Goods

Class 25

women's underwear; undergarments, namely brassieres, girdles, corsets, pants, panties, slips, culottes, garters, hosiery, stockings and tights; lingerie; pyjamas, nightgowns and housecoats; swim suits, bikinis, beachwear, namely dresses, tunics and ponchos; hats and turbans

Application Number 1,967,145
Language of Application English

Filing Date 2019-06-05

APPLICANT AND AGENT DETAILS

Applicant

SATA GmbH & Co. KG, a legal entity
Domertalstraße 20
D-70806 Kornwestheim
GERMANY

Agent

RICHEs, MCKENZIE & HERBERT LLP
SUITE 1800, 2 BLOOR STREET EAST,
TORONTO, ONTARIO, M4W3J5

TRADEMARK DETAILS

minijet X

Trademark Type

Word

Goods

Class 07

spraying machines for the atomization of liquids and coatings, namely, paints, wood stains, varnishes, lacquers, textured wall finishes, glazes, glues, primers, fillers and spray putties for use in the painting and industrial paint fields; spraying machines for the atomization of paints in the automotive field; spraying machines for the atomization of antimicrobial agents and mold inhibitors to cleaning tanks, equipment and floors of industrial plants; automatic dispensing machines that dispense liquids and coatings, namely, paints, wood stains, varnishes, lacquers, textured wall finishes, glazes, glues, primers, fillers and spray putties for use in the painting and industrial paint fields; automatic dispensing machines that dispense paints in the automotive field; automatic dispensing machines that dispense antimicrobial agents and mold inhibitors to cleaning tanks, equipment and floors of industrial plants; air brushes for applying paint; compressed air spray guns that dispense liquids and coatings, namely, paints, wood stains, varnishes, lacquers, textured wall finishes, glazes, glues, primers, fillers and spray putties for use in the painting and industrial paint fields; compressed air spray guns that dispense paints in the automotive field; compressed air spray guns that dispense antimicrobial agents and mold inhibitors to cleaning tanks, equipment and floors of industrial plants; compressed air sprayers for the atomization of liquids and coatings, namely, paints, wood stains, varnishes, lacquers, textured wall finishes, glazes, glues, primers, fillers and spray putties for use in the painting and industrial paint fields; compressed air sprayers for the atomization of paints in the automotive field; compressed air sprayers for the atomization of antimicrobial agents and mold inhibitors to cleaning tanks, equipment and floors of industrial plants; guns for compressed air spraying machines that dispense liquids and coatings, namely, paints, wood stains, varnishes, lacquers, textured wall finishes, glazes, glues, primers, fillers and spray putties for use in the painting and industrial paint fields; guns for compressed air spraying machines that dispense paints in the automotive field; guns for compressed air spraying machines that dispense antimicrobial agents and mold inhibitors to cleaning tanks, equipment and floors of industrial plants; guns for compressed liquid spraying machines that dispense liquids and coatings, namely, paints, wood stains, varnishes, lacquers, textured wall finishes, glazes, glues, primers, fillers and spray putties for use in the painting and industrial paint fields; guns for compressed liquid spraying machines that dispense paints in the automotive field; guns for compressed liquid spraying machines that dispense antimicrobial agents and mold inhibitors to cleaning tanks,

equipment and floors of industrial plants; painting machines incorporating spray guns; robotic guns for compressed air spraying machines that dispense liquids and coatings, namely, paints, wood stains, varnishes, lacquers, textured wall finishes, glazes, glues, primers, fillers and spray putties for use in the painting and industrial paint fields; robotic guns for compressed air spraying machines that dispense paints in the automotive field; robotic guns for compressed air spraying machines that dispense antimicrobial agents and mold inhibitors to cleaning tanks, equipment and floors of industrial plants; robotic guns for compressed liquid spraying machines that dispense liquids and coatings, namely, paints, wood stains, varnishes, lacquers, textured wall finishes, glazes, glues, primers, fillers and spray putties for use in the painting and industrial paint fields; robotic guns for compressed liquid spraying machines that dispense paints in the automotive field; robotic guns for compressed liquid spraying machines that dispense antimicrobial agents and mold inhibitors to cleaning tanks, equipment and floors of industrial plants; spray paint machines; supports for spray paint guns, namely, paint spray gun stands, paint spray gun holders; spray guns for the atomization of liquids and coatings, namely, paints, wood stains, varnishes, lacquers, textured wall finishes, glazes, glues, primers, fillers and spray putties for use in the painting and industrial paint fields; spray guns for the atomization of paints in the automotive field; spray guns for the atomization of antimicrobial agents and mold inhibitors to cleaning tanks, equipment and floors of industrial plants; spray gun machines for the atomization of liquids and coatings, namely, paints, wood stains, varnishes, lacquers, textured wall finishes, glazes, glues, primers, fillers and spray putties for use in the painting and industrial paint fields; spray gun machines for the atomization of paints in the automotive field; spray gun machines for the atomization of antimicrobial agents and mold inhibitors to cleaning tanks, equipment and floors of industrial plants; paint spray guns; automatic robotic spray guns for paint; paint cups for spray guns; nozzle sets for paint spray guns used for car refinishing; paint containers and paint container closures; nozzles for paint spray guns used for car refinishing; paint spraying equipment, namely, extensions for spray guns for applying coatings, air pressure measuring devices for paint spray guns, parts and fittings for the aforementioned goods

Claims

Priority Filing Date: January 03, 2019, Country or Office: EUIPO (EU), Application No: 018006112 in association with the same kind of goods

Application Number 1,967,281
Language of Application English

Filing Date 2019-06-06

APPLICANT AND AGENT DETAILS

Applicant

SHENZHEN 4PX EXPRESS CO., LTD.
309-310/313-315, AIR CARGO TERMINALS
(DOMESTIC CARGO TERMINALS), AIRPORT
ROUTE 4
SHENZHEN INTERNATIONAL AIRPORT,
BAO'AN DIST., SHENZHEN, GUANGDONG
518128
CHINA

Agent

NEOMARK LTD.
7450 rue Saint-Hubert, Montréal, QUEBEC,
H2R2N3

TRADEMARK DETAILS

Trademark Type

Design

Visual Representation



Services

Class 35

(1) Direct mail advertising of the goods and services of others; on-line advertising for others on computer networks; publicity agency services; business management and organization consultancy; import-export agency services; procurement of contracts for the purchase and sale of goods and services; market analysis and research; relocation services for businesses; search engine optimisation; developing marketing strategies and marketing concepts for others.

Class 39

(2) Freight forwarding; supply chain logistics and reverse logistics services consisting of the transportation of goods for others by air, rail, ship or truck; merchandise packaging; cargo ship transport; truck transport; freight transportation by rail; freight transportation by air; supply chain logistics and reverse logistics services consisting of the storage of goods for others by air, rail, ship or truck; rental of storage containers; courier services.

Class 42

(3) Packaging design; providing search engines for the internet; rental of computer software; conversion of data or documents from physical to electronic media; creating and maintaining web sites for others; computer programming consultancy; computer security consultancy; cloud computing provider services for general storage of data; providing information on computer technology and programming via a web site; technical support services in the form of troubleshooting of computer hardware and software problems.

Application Number 1,967,297
Language of Application English

Filing Date 2019-06-06

APPLICANT AND AGENT DETAILS

Applicant

Hummingbird Group Ltd.
301-8800 Dufferin St
Concord
ONTARIO
L4K0C5

Agent

EDWARD MANCINELLI
(Mancinelli Professional Corporation), 234
Eglinton Avenue East, Suite 501, Toronto,
ONTARIO, M4P1K5

TRADEMARK DETAILS

HUMMINGBIRD

Trademark Type

Word

Services

Class 45

Legal services; legal research services; legal information services; legal document preparation services; legal consultation services; online social networking services in the field of legal affairs.

Application Number 1,967,298
Language of Application English

Filing Date 2019-06-06

APPLICANT AND AGENT DETAILS

Applicant

Hummingbird Group Ltd.
301-8800 Dufferin St
Concord
ONTARIO
L4K0C5

Agent

EDWARD MANCINELLI
(Mancinelli Professional Corporation), 234
Eglinton Avenue East, Suite 501, Toronto,
ONTARIO, M4P1K5

TRADEMARK DETAILS

Trademark Type

Design

Visual Representation



hummingbird

Services

Class 45

Legal services; legal research services; legal information services; legal document preparation services; legal consultation services; online social networking services in the field of legal affairs.

Application Number 1,967,523
Language of Application English

Filing Date 2019-06-06

APPLICANT AND AGENT DETAILS

Applicant

Zelios Canada Holdings Corp.
2400-525 8 Ave SW
Calgary
ALBERTA
T2P1G1

Agent

OYEN WIGGS GREEN & MUTALA LLP
480-THE STATION, 601 WEST CORDOVA
STREET, VANCOUVER, BRITISH
COLUMBIA, V6B1G1

TRADEMARK DETAILS

Trademark Type

Design

Visual Representation



Goods

Class 29

Edible oil, namely hemp oil

Application Number 1,967,730
Language of Application English

Filing Date 2019-06-07

APPLICANT AND AGENT DETAILS

Applicant

Tsitsidzashe Pena
36 Lisgar St
Toronto
ONTARIO
M6J0C7

Agent

WITMART INC.
34 King Street East, Suite 500, Toronto,
ONTARIO, M5C2X8

TRADEMARK DETAILS

Trademark Type

Design

Visual Representation



Goods

Class 25

Denim jackets; Denim jeans; Denim pants; Dresses; Gloves; Hats; Headbands; Hooded sweatshirts; Jackets; Overalls; Pants; Shoes; Shorts; Socks; Sweaters; T-Shirts; Track suits; Underwear; Vests; sweatbands

Services

Class 35

On-line retail store services featuring clothing

Application Number 1,967,799
Language of Application English

Filing Date 2019-06-07

APPLICANT AND AGENT DETAILS

Applicant

Mastronardi Produce Ltd.
c/o Dinsmore & Shohl LLP
900 Wilshire Drive, Suite 300
Troy, MI 48084
UNITED STATES OF AMERICA

Agent

RIDOUT & MAYBEE LLP
5500 North Service Road, Suite 101,
Burlington, ONTARIO, L7L6W6

TRADEMARK DETAILS

TASTES LIKE A STRAWBERRY SHOULD

Trademark Type

Standard Characters

Goods

Class 31

Fresh fruits

Application Number 1,967,803
Language of Application English

Filing Date 2019-06-07

APPLICANT AND AGENT DETAILS

Applicant

Mastronardi Produce Ltd.
c/o Dinsmore & Shohl LLP
900 Wilshire Drive, Suite 300
Troy, MI 48084
UNITED STATES OF AMERICA

Agent

RIDOUT & MAYBEE LLP
5500 North Service Road, Suite 101,
Burlington, ONTARIO, L7L6W6

TRADEMARK DETAILS

MIRACULOUSLY SWEET

Trademark Type

Standard Characters

Goods

Class 31

Fresh fruits

Application Number 1,967,806
Language of Application English

Filing Date 2019-06-07

APPLICANT AND AGENT DETAILS

Applicant

Mastronardi Produce Ltd.
c/o Dinsmore & Shohl LLP
900 Wilshire Drive, Suite 300
Troy, MI 48084
UNITED STATES OF AMERICA

Agent

RIDOUT & MAYBEE LLP
5500 North Service Road, Suite 101,
Burlington, ONTARIO, L7L6W6

TRADEMARK DETAILS

POPPIN' WITH FLAVOR

Trademark Type

Standard Characters

Goods

Class 31

Fresh fruits

Application Number 1,967,810
Language of Application English

Filing Date 2019-06-07

APPLICANT AND AGENT DETAILS

Applicant

Mastronardi Produce Ltd.
c/o Dinsmore & Shohl LLP
900 Wilshire Drive, Suite 300
Troy, MI 48084
UNITED STATES OF AMERICA

Agent

RIDOUT & MAYBEE LLP
5500 North Service Road, Suite 101,
Burlington, ONTARIO, L7L6W6

TRADEMARK DETAILS

A BURST OF BRILLIANCE

Trademark Type

Standard Characters

Goods

Class 31

Fresh fruits

Application Number 1,967,950
Language of Application English

Filing Date 2019-06-10

APPLICANT AND AGENT DETAILS

Applicant

NINGBO GAOPU OUTDOOR PRODUCTS
CO., LTD.
Changyang Village, Shendian Town, Ninghai
County
Ningbo City, Zhejiang Province 315000
CHINA

Agent

PILLAR IP, INC.
1661 Shauna Crescent, Greely, ONTARIO,
K4P1M8

TRADEMARK DETAILS

Trademark Type

Design

Visual Representation



Goods

Class 20

Chairs, Cradles, Deck chairs, Inflatable furniture, Wooden step stools, Beds, Sleeping pads, Camping mattresses, Furniture partitions of wood

Application Number 1,967,972
Language of Application English

Filing Date 2019-06-10

APPLICANT DETAILS

Applicant

Dry Care LLC
1276 46th Street suite #211
Brooklyn, NY 11219
UNITED STATES OF AMERICA

TRADEMARK DETAILS

DRY CARE

Trademark Type

Word

Goods

Class 05

Diapers for incontinence; Disposable diapers for incontinence; Incontinence diapers; Incontinence garments; Incontinence pads; Sanitary napkins; Sanitary pads; Sanitary panties

Application Number 1,968,302
Language of Application English

Filing Date 2019-06-10

APPLICANT AND AGENT DETAILS

Applicant

M. DIAS BRANCO S.A. INDÚSTRIA E
COMÉRCIO DE ALIMENTOS
Rodovia BR 116, Km 18, s/nº, Eusébio
Ceará
BRAZIL

Agent

SMART & BIGGAR LLP
SUITE 900, 55 METCALFE STREET, P.O.
BOX 2999, STATION D, OTTAWA, ONTARIO,
K1P5Y6

TRADEMARK DETAILS

Trademark Type

Design

Visual Representation



Goods

Class 30

Farinaceous food pastes for human consumption; rusks; biscuits; cookies; wheat meal; flour for food; macaroni; pasta; bread rolls; bread; toasts; waffles; cakes; cake powder; high-protein cereal bars; noodles

Application Number 1,968,410
Language of Application English

Filing Date 2019-06-10

APPLICANT AND AGENT DETAILS

Applicant

Avian Enterprises, LLC
221 Ocean Grande Blvd., Suite 801
Jupiter, FL 33477
UNITED STATES OF AMERICA

Agent

RIDOUT & MAYBEE LLP
11 Holland Avenue, Suite 601 , Ottawa,
ONTARIO, K1Y4S1

TRADEMARK DETAILS

SPRAY ON . . . BIRDS GONE!

Trademark Type

Standard Characters

Goods

Class 05

animal repellents

Claims

Priority Filing Date: February 25, 2019, Country or Office: UNITED STATES OF AMERICA,
Application No: 88314822 in association with the same kind of goods

Application Number 1,969,141
Language of Application English

Filing Date 2019-06-11

APPLICANT AND AGENT DETAILS

Applicant

CHURCH & DWIGHT CO., INC.
500 Charles Ewing Boulevard
Ewing, NJ 08628
UNITED STATES OF AMERICA

Agent

BAKER & MCKENZIE LLP
BROOKFIELD PLACE, 181 BAY STREET,
SUITE 2100, P.O. BOX 874, TORONTO,
ONTARIO, M5J2T3

TRADEMARK DETAILS

DIVINE

Trademark Type

Standard Characters

Goods

Class 10

Adult sexual stimulation aids, namely, personal vibrators

Application Number 1,969,142
Language of Application English

Filing Date 2019-06-11

APPLICANT AND AGENT DETAILS

Applicant

Kang Tu, Inc.
5362 Via Apolina
Yorba Linda, CA 92886
UNITED STATES OF AMERICA

Agent

MCMILLAN LLP
1500 - 1055 WEST GEORGIA STREET, P.O.
BOX 11117, ROYAL CENTRE, VANCOUVER,
BRITISH COLUMBIA, V6E4N7

TRADEMARK DETAILS

LAMEIZI

Trademark Type

Standard Characters

Foreign Character Translation

As provided by the applicant, the translation of the trademark is Spicy Sister.

Services

Class 43

restaurant

Application Number 1,969,265
Language of Application English

Filing Date 2019-06-11

APPLICANT AND AGENT DETAILS

Applicant

Yongqi Liang
Unit 101,Block 2,Hexinyajing Garden,No.39,
Annan Road,Taijiang District Fuzhou
Fujian, 350004
CHINA

Agent

WITMART INC.
34 King Street East, Suite 500, Toronto,
ONTARIO, M5C2X8

TRADEMARK DETAILS

Trademark Type

Design

Visual Representation

careuokin

Goods

Class 25

bathing suits; business clothing; casual clothing; coats; girdles; gloves; hats; hosiery; layettes;
neckties; scarves; shawls; shirts; shoes; skirts; sweaters; trousers; underwear; vests

Application Number 1,969,672
Language of Application English

Filing Date 2019-06-12

APPLICANT AND AGENT DETAILS

Applicant

GRUPO MUNRECO, S.L.
CIF B28557064
Avenida de Bruselas, 32
28108 Alcobendas
Madrid
SPAIN

Agent

THERRIEN COUTURE JOLI-COEUR S.E.N.C.
R.L.
1100, boul. René-Lévesque O., #2000,
Montréal, QUEBEC, H3B4N4

TRADEMARK DETAILS

VICEROY

Trademark Type

Word

Goods

Class 14

Jewellery; wristwatches; watches; jewellery boxes and watch boxes

Application Number 1,969,710
Language of Application English

Filing Date 2019-06-12

APPLICANT AND AGENT DETAILS

Applicant

Melaleuca, Inc.
4609 West 65th South
Idaho Falls, ID 83402
UNITED STATES OF AMERICA

Agent

BLAKE, CASSELS & GRAYDON LLP
INTELLECTUAL PROPERTY GROUP, SUITE
4000, COMMERCE COURT WEST, 199 BAY
STREET, TORONTO, ONTARIO, M5L1A9

TRADEMARK DETAILS

CALMICID

Trademark Type

Word

Goods

Class 05

antacid

Application Number 1,969,937
Language of Application English

Filing Date 2019-06-12

APPLICANT AND AGENT DETAILS

Applicant

Skullcandy, Inc.
6301 N. Landmark Dr.
Park City, UT 84098
UNITED STATES OF AMERICA

Agent

BENNETT JONES LLP
3200 TELUS HOUSE, SOUTH TOWER, 10020
- 100TH STREET, EDMONTON, ALBERTA,
T5J0N3

TRADEMARK DETAILS

ALL DAY MOTIVATION

Trademark Type

Word

Goods

Class 09

Headphones, earphones

Application Number 1,969,939
Language of Application English

Filing Date 2019-06-12

APPLICANT AND AGENT DETAILS

Applicant

Skullcandy, Inc.
6301 N. Landmark Dr.
Park City, UT 84098
UNITED STATES OF AMERICA

Agent

BENNETT JONES LLP
3200 TELUS HOUSE, SOUTH TOWER, 10020
- 100TH STREET, EDMONTON, ALBERTA,
T5J0N3

TRADEMARK DETAILS

DEEPER DIMENSIONS OF SOUND

Trademark Type

Word

Goods

Class 09

Headphones, earphones

Application Number 1,969,940
Language of Application English

Filing Date 2019-06-12

APPLICANT AND AGENT DETAILS

Applicant

Skullcandy, Inc.
6301 N. Landmark Dr.
Park City, UT 84098
UNITED STATES OF AMERICA

Agent

BENNETT JONES LLP
3200 TELUS HOUSE, SOUTH TOWER, 10020
- 100TH STREET, EDMONTON, ALBERTA,
T5J0N3

TRADEMARK DETAILS

CREATE YOUR OWN SPACE

Trademark Type

Word

Goods

Class 09

Headphones, earphones

Application Number 1,969,941
Language of Application English

Filing Date 2019-06-12

APPLICANT AND AGENT DETAILS

Applicant

Skullcandy, Inc.
6301 N. Landmark Dr.
Park City, UT 84098
UNITED STATES OF AMERICA

Agent

BENNETT JONES LLP
3200 TELUS HOUSE, SOUTH TOWER, 10020
- 100TH STREET, EDMONTON, ALBERTA,
T5J0N3

TRADEMARK DETAILS

CRUSHER ANC

Trademark Type

Word

Goods

Class 09

Headphones, earphones

Application Number 1,969,970
Language of Application English

Filing Date 2019-06-12

APPLICANT AND AGENT DETAILS

Applicant

SP Nutraceuticals Inc.
5063 North Service Road
Suite 100
Burlington
ONTARIO
L7L5H6

Agent

FOGLER, RUBINOFF LLP
77 KING STREET WEST, SUITE 3000, P.O.
Box 95, TORONTO-DOMINION CENTRE,
TORONTO, ONTARIO, M5K1G8

TRADEMARK DETAILS

AvoB

Trademark Type

Word

Goods

Class 05

Dietary and nutritional supplements for promoting weight loss, general health and well-being, insulin sensitivity, and a healthy glucose metabolism

Application Number 1,970,071
Language of Application English

Filing Date 2019-06-12

APPLICANT AND AGENT DETAILS

Applicant

GTH Technologies Inc.
200-10328 81 Ave NW
Edmonton
ALBERTA
T6E1X2

Agent

NATHAN WOODRUFF
200 - 10328 81 Avenue NW, Edmonton,
ALBERTA, T6E1X2

TRADEMARK DETAILS

Trademark Type

Design

Visual Representation



Colour Claim

Colour is claimed as a feature of the trademark. the stylized leaf is green and the stylized flower is orange

Goods

Class 08

garden hoes; gardening tools; gardening trowels; hand cultivators; hand-held lawn rakes; hand-operated tampers; ice scrapers; pitchforks; rakes; shovels; snow shovels; landscaping tools, namely rakes, shovels, scrapers, trowels, hoes, and cultivators;

Application Number 1,970,159
Language of Application English

Filing Date 2019-06-12

APPLICANT AND AGENT DETAILS

Applicant

Société des Produits Nestlé S.A.
Avenue Nestlé 55
Vevey, 1800
SWITZERLAND

Agent

EMMANUELLE PARÉ
CP 161, Saint-Philippe BP, QUEBEC, J0L2K0

TRADEMARK DETAILS

Trademark Type

Design

Visual Representation

STANDARDIZED•FULL POTENCY

Goods

Class 05

Vitamins; vitamin preparations; multivitamins; multivitamin preparations; mineral supplements; dietary, nutritional and herbal supplements for general health and well-being

Application Number 1,970,342
Language of Application English

Filing Date 2019-06-12

APPLICANT AND AGENT DETAILS

Applicant

DIXON TICONDEROGA COMPANY
2525 North Casaloma Drive
Appleton, Wisconsin 54913
UNITED STATES OF AMERICA

Agent

BORDEN LADNER GERVAIS LLP
World Exchange Plaza, 100 Queen Street,
Suite 1300, Ottawa, ONTARIO, K1P1J9

TRADEMARK DETAILS

ASPEN

Trademark Type

Word

Goods

Class 16

Artists' brushes; artist brush sets consisting of artists' brushes

Application Number 1,970,560
Language of Application English

Filing Date 2019-06-12

APPLICANT AND AGENT DETAILS

Applicant

Melaleuca, Inc.
4609 West 65th South
Idaho Falls, ID 83402
UNITED STATES OF AMERICA

Agent

BLAKE, CASSELS & GRAYDON LLP
INTELLECTUAL PROPERTY GROUP, SUITE
4000, COMMERCE COURT WEST, 199 BAY
STREET, TORONTO, ONTARIO, M5L1A9

TRADEMARK DETAILS

SUN SHADES

Trademark Type

Word

Goods

Class 03

after sun gel, lip balm, sun care products, namely sunscreen

Application Number 1,970,688
Language of Application French

Filing Date 2019-06-12

APPLICANT AND AGENT DETAILS

Applicant

L'Équipe Spectra inc.
901-400 boul. De Maisonneuve Ouest
Montréal
QUÉBEC
H3A1L4

Agent

BCF S.E.N.C.R.L./BCF LLP
1100, boul. René-Lévesque Ouest, 25e Étage,
Montréal, QUÉBEC, H3B5C9

TRADEMARK DETAILS

SPECTRUM

Trademark Type

Word

Services

Class 41

(1) Operation of performance venues; musical and theatrical performances organized in a performance venue; operation of dinner theatres.

Class 43

(2) Rental of rooms for social functions.

Application Number 1,970,700
Language of Application English

Filing Date 2019-06-12

APPLICANT DETAILS

Applicant
SCENTSY CANADA ENTERPRISES
340 Henry Street #15 LWR
BRANTFORD
ONTARIO
N3S7V9

TRADEMARK DETAILS

Authentic Scentsy Laundry, Est. 2004

Trademark Type
Word

Goods

Class 03

Anti-static dryer sheets; fabric softeners for laundry use; laundry detergent; laundry detergents; laundry fabric conditioner; laundry soap

Application Number 1,970,869
Language of Application English

Filing Date 2019-06-12

APPLICANT AND AGENT DETAILS

Applicant

Sanford, L.P.
6655 Peachtree Dunwoody Road
Atlanta, GA 30328
UNITED STATES OF AMERICA

Agent

GOWLING WLG (CANADA) LLP
SUITE 1600, 1 FIRST CANADIAN PLACE, 100
KING STREET WEST, TORONTO, ONTARIO,
M5X1G5

TRADEMARK DETAILS

SHARPIE ROLLER

Trademark Type

Word

Goods

Class 16

Pens, highlighter pens, highlighting markers

Application Number 1,971,010
Language of Application English

Filing Date 2019-06-12

APPLICANT AND AGENT DETAILS

Applicant

Wicked Fashions, Inc.
222 Bridge Plaza South
Fort Lee, NJ 07024
UNITED STATES OF AMERICA

Agent

GOWLING WLG (CANADA) LLP
SUITE 1600, 1 FIRST CANADIAN PLACE, 100
KING STREET WEST, TORONTO, ONTARIO,
M5X1G5

TRADEMARK DETAILS

Trademark Type

Design

Visual Representation



Goods

Class 09

sunglasses, eyeglass frames, eyewear cases

Application Number 1,971,202
Language of Application English

Filing Date 2019-06-17

APPLICANT AND AGENT DETAILS

Applicant

ALPHA GROUP CO., LTD.
Alpha Animation Industrial Area,
Jinhong Road East & Fengxiang Road North,
Chenghai District, Shantou,
Guangdong, P.R.
CHINA

Agent

CHOOI LAW PROFESSIONAL
CORPORATION
738 Spadina Avenue, Suite 200, Toronto,
ONTARIO, M5S2J8

TRADEMARK DETAILS

Trademark Type

Design

Visual Representation



Goods

Class 28

Action skill games; board games; chess games; educational games for children; go games; video game consoles; arm bands featuring motion sensors and gesture control software for use with interactive video games; hand-held joystick units for playing video games; amusement park rides; kites; toy cars; toy vehicles; baby toys; action figure toys; toy figures; toy robots; parlor games; baby gyms; tricycles for infants; dolls; plush toys; jigsaw puzzles; remote-controlled scale model vehicles; balls for juggling; balls for playing handball; balls for playing paddleball; balls for playing racketball; balls for playing soccer; balls for rhythmic gymnastics; rackets for tennis and badminton; table tennis rackets; resistance machines for exercise; inflatable games for swimming pools; inflatable swimming floats; racing lanes for swimming pools; rubber toys; toy vehicle tracks; roller skates; in-line roller skates; fishing tackle; toy scooters; toy building blocks; spinning tops; playing cards; ornaments for Christmas trees; scale model vehicles; remote-controlled toy vehicles.

Application Number 1,971,221
Language of Application English

Filing Date 2019-06-17

APPLICANT AND AGENT DETAILS

Applicant
SUZHOU EAE AUTOMOTIVE EQUIPMENT
CO., LTD.
1089 NORTH YUNLIAN ROAD
WUJIANG EDZ
SUZHOU, 215200
CHINA

Agent
NEOMARK LTD.
7450 rue Saint-Hubert, Montréal, QUEBEC,
H2R2N3

TRADEMARK DETAILS

Trademark Type
Design

Visual Representation



EAE

Goods

Class 07

Automotive hoists; Electric jacks; Elevating apparatus, namely car lifts; Cargo lifting derricks; Cranes; Power-operated lifts for moving, parking and storing land vehicles; Robotic controlled mechanical parking lifts for multi-layered parking; Electricity generators; Pneumatic transporters; Elevator lifts.

Application Number 1,971,389
Language of Application English

Filing Date 2019-06-17

APPLICANT AND AGENT DETAILS

Applicant

Fifth Third Bancorp
38 Fountain Square
Cincinnati, OH 45202
UNITED STATES OF AMERICA

Agent

METHOD LAW PROFESSIONAL
CORPORATION
4211 Yonge Street, Suite 310, Toronto,
ONTARIO, M2P2A9

TRADEMARK DETAILS

FIFTH THIRD BUSINESS CAPITAL

Trademark Type

Standard Characters

Services

Class 36

Commercial lending.

Claims

Priority Filing Date: May 23, 2019, Country or Office: UNITED STATES OF AMERICA, Application No: 88443651 in association with the same kind of services

Application Number 1,971,542
Language of Application English

Filing Date 2019-06-18

APPLICANT AND AGENT DETAILS

Applicant

BRACCO SUISSE S.A.
Via Ponteggia 23
6814 CADEMPINO,
SWITZERLAND

Agent

ROBIC
630, boul. René-Lévesque Ouest, 20e étage,
Montréal, QUEBEC, H3B1S6

TRADEMARK DETAILS

BOPTAMIRON

Trademark Type

Standard Characters

Goods

Class 05

contrast media for in-vivo imaging.

Application Number 1,971,552
Language of Application English

Filing Date 2019-06-18

APPLICANT AND AGENT DETAILS

Applicant

L'Oréal (UK) Limited
255 Hammersmith Road
London W6 8AZ
UNITED KINGDOM

Agent

FASKEN MARTINEAU DUMOULIN LLP
Tour de la Bourse, Suite 3500, P.O. box 242,
800, Place Victoria, Montréal, QUEBEC,
H4Z1E9

TRADEMARK DETAILS

SEQUIN CRUSH

Trademark Type

Standard Characters

Goods

Class 03

Makeup preparations.

Claims

Priority Filing Date: May 02, 2019, Country or Office: UNITED KINGDOM, Application No: UK00003396618 in association with the same kind of goods

Application Number 1,971,560
Language of Application English

Filing Date 2019-06-18

APPLICANT AND AGENT DETAILS

Applicant

EPOCH COMPANY, LTD.
2-2, 2-Chome
Komagata, Taito-ku
Tokyo, 111-8618
JAPAN

Agent

RIDOUT & MAYBEE LLP
250 University Avenue, 5th Floor, Toronto,
ONTARIO, M5H3E5

TRADEMARK DETAILS

Trademark Type

Design

Visual Representation

The logo for 'Baby Collectibles' features the word 'Baby' in a pink, rounded font with a small yellow house icon above the 'y'. The word 'Collectibles' is in a similar pink, rounded font. The entire logo is outlined in pink.

Colour Claim

Colour is claimed as a feature of the trademark. The letters Baby Collectibles are pink and outlined in pink with a small yellow house joining the two words

Goods

Class 28

Dolls and accessories therefor; toy animals and accessories therefor

Application Number 1,971,719
Language of Application English

Filing Date 2019-06-18

APPLICANT DETAILS

Applicant
Anthony Cerilli
42 Harris Pl
Nepean
ONTARIO
K2G2P6

TRADEMARK DETAILS

Trademark Type
Design

Visual Representation



Colour Claim

Colour is claimed as a feature of the trademark. The outline of t shirt is black with red heart inside and black lettering of Contribu and red lettering tees as one word.

Goods

Class 25

T-shirts, hoodies, hats, gloves, pants, socks, shoes

Application Number 1,971,762
Language of Application English

Filing Date 2019-06-19

APPLICANT AND AGENT DETAILS

Applicant

EXXON MOBIL CORPORATION
5959 Las Colinas Blvd.
Irving, TX 75039-2298
UNITED STATES OF AMERICA

Agent

GOWLING WLG (CANADA) LLP
SUITE 2600, 160 ELGIN STREET, OTTAWA,
ONTARIO, K1P1C3

TRADEMARK DETAILS

Trademark Type

Design

Visual Representation



Goods

Class 09

Magnetically encoded credit cards; microchip cards

Services

Class 36

Charge card and credit card payment processing services

Application Number 1,971,986
Language of Application English

Filing Date 2019-06-20

APPLICANT AND AGENT DETAILS

Applicant

BAYER AKTIENGESELLSCHAFT
Kaiser-Wilhelm-Allee, 51373
Leverkusen,
GERMANY

Agent

GOWLING WLG (CANADA) LLP
SUITE 2600, 160 ELGIN STREET, OTTAWA,
ONTARIO, K1P1C3

TRADEMARK DETAILS

BRODAL

Trademark Type

Standard Characters

Goods

Class 05

Preparations for destroying vermin; fungicides, herbicides

Application Number 1,971,993
Language of Application English

Filing Date 2019-06-20

APPLICANT AND AGENT DETAILS

Applicant

New Chapter, Inc.
90 Technology Drive
Brattleboro, VT 05301
UNITED STATES OF AMERICA

Agent

WILSON LUE LLP
250 University Avenue, 5th Floor, Toronto,
ONTARIO, M5H3E5

TRADEMARK DETAILS

COLLAGEN GLOW

Trademark Type

Standard Characters

Goods

Class 05

Vitamins; dietary and nutritional supplements consisting of herbs, vegetables, fruits, grains and fish oil, in capsule, liquid and powder form, to improve general health; nutritional and dietary supplements, namely, probiotic nutrients in capsule, liquid and powder form, to improve general health; nutritional and dietary supplements, namely, mushrooms and mushroom extracts in capsule, liquid and powder form, to improve general health; nutritional and dietary supplements consisting of herb, vegetable, fruit and grain extracts, in capsule, liquid and powder form, to improve general health

Application Number 1,972,089
Language of Application English

Filing Date 2019-06-20

APPLICANT AND AGENT DETAILS

Applicant

Hoshizaki America, Inc.
618 Highway 74 South
Peachtree City, GA 30269
UNITED STATES OF AMERICA

Agent

BORDEN LADNER GERVAIS LLP
World Exchange Plaza, 100 Queen Street,
Suite 1300, Ottawa, ONTARIO, K1P1J9

TRADEMARK DETAILS

STEELHEART

Trademark Type

Standard Characters

Goods

Class 11

refrigerators and freezers

Application Number 1,972,288
Language of Application English

Filing Date 2019-06-21

APPLICANT AND AGENT DETAILS

Applicant

All-Risks Insurance Brokers Limited
1255 Ouellette Avenue
Windsor
ONTARIO
N8X1J3

Agent

RIDOUT & MAYBEE LLP
11 Holland Avenue, Suite 601 , Ottawa,
ONTARIO, K1Y4S1

TRADEMARK DETAILS

Trademark Type

Design

Visual Representation



Services

Class 36

insurance brokerage services

Application Number 1,972,370
Language of Application English

Filing Date 2019-06-24

APPLICANT AND AGENT DETAILS

Applicant

IGT
9295 Prototype Drive
Reno, Nevada 89521
UNITED STATES OF AMERICA

Agent

COLLEEN CAISSIE-DUPUIS
(c/o IGT Canada Solutions ULC), 328 Urquhart
Avenue, Moncton, NEW BRUNSWICK,
E1H2R6

TRADEMARK DETAILS

PEAKSTEPPER

Trademark Type

Standard Characters

Goods

Class 28

Gaming machines, namely, devices which accept a wager; Reconfigurable casino and lottery gaming equipment, namely, gaming machines and operational computer game software therefor sold as a unit

Claims

Priority Filing Date: June 04, 2019, Country or Office: UNITED STATES OF AMERICA, Application No: 88458185 in association with the same kind of goods

Application Number 1,972,372
Language of Application English

Filing Date 2019-06-24

APPLICANT AND AGENT DETAILS

Applicant

IGT
9295 Prototype Drive
Reno, Nevada 89521
UNITED STATES OF AMERICA

Agent

COLLEEN CAISSIE-DUPUIS
(c/o IGT Canada Solutions ULC), 328 Urquhart
Avenue, Moncton, NEW BRUNSWICK,
E1H2R6

TRADEMARK DETAILS

PEAKDUAL

Trademark Type

Standard Characters

Goods

Class 28

Gaming machines, namely, devices which accept a wager; Reconfigurable casino and lottery gaming equipment, namely, gaming machines and operational computer game software therefor sold as a unit

Claims

Priority Filing Date: June 04, 2019, Country or Office: UNITED STATES OF AMERICA, Application No: 88458190 in association with the same kind of goods

Application Number 1,972,373
Language of Application English

Filing Date 2019-06-24

APPLICANT AND AGENT DETAILS

Applicant

IGT
9295 Prototype Drive
Reno, Nevada 89521
UNITED STATES OF AMERICA

Agent

COLLEEN CAISSIE-DUPUIS
(c/o IGT Canada Solutions ULC), 328 Urquhart
Avenue, Moncton, NEW BRUNSWICK,
E1H2R6

TRADEMARK DETAILS

PEAKWHEEL

Trademark Type

Standard Characters

Goods

Class 28

Gaming machines, namely, devices which accept a wager; Reconfigurable casino and lottery gaming equipment, namely, gaming machines and operational computer game software therefor sold as a unit

Claims

Priority Filing Date: June 04, 2019, Country or Office: UNITED STATES OF AMERICA, Application No: 88458186 in association with the same kind of goods

Application Number 1,972,374
Language of Application English

Filing Date 2019-06-24

APPLICANT AND AGENT DETAILS

Applicant

IGT
9295 Prototype Drive
Reno, Nevada 89521
UNITED STATES OF AMERICA

Agent

COLLEEN CAISSIE-DUPUIS
(c/o IGT Canada Solutions ULC), 328 Urquhart
Avenue, Moncton, NEW BRUNSWICK,
E1H2R6

TRADEMARK DETAILS

PEAKSLANT49

Trademark Type

Standard Characters

Goods

Class 28

Gaming machines, namely, devices which accept a wager; Reconfigurable casino and lottery gaming equipment, namely, gaming machines and operational computer game software therefor sold as a unit

Claims

Priority Filing Date: June 04, 2019, Country or Office: UNITED STATES OF AMERICA, Application No: 88458187 in association with the same kind of goods

Application Number 1,972,375
Language of Application English

Filing Date 2019-06-24

APPLICANT AND AGENT DETAILS

Applicant

IGT
9295 Prototype Drive
Reno, Nevada 89521
UNITED STATES OF AMERICA

Agent

COLLEEN CAISSIE-DUPUIS
(c/o IGT Canada Solutions ULC), 328 Urquhart
Avenue, Moncton, NEW BRUNSWICK,
E1H2R6

TRADEMARK DETAILS

PEAKBAR

Trademark Type

Standard Characters

Goods

Class 28

Gaming machines, namely, devices which accept a wager; Reconfigurable casino and lottery gaming equipment, namely, gaming machines and operational computer game software therefor sold as a unit

Claims

Priority Filing Date: June 04, 2019, Country or Office: UNITED STATES OF AMERICA, Application No: 88458182 in association with the same kind of goods

Application Number 1,972,376
Language of Application English

Filing Date 2019-06-24

APPLICANT AND AGENT DETAILS

Applicant

IGT
9295 Prototype Drive
Reno, Nevada 89521
UNITED STATES OF AMERICA

Agent

COLLEEN CAISSIE-DUPUIS
(c/o IGT Canada Solutions ULC), 328 Urquhart
Avenue, Moncton, NEW BRUNSWICK,
E1H2R6

TRADEMARK DETAILS

SION

Trademark Type

Standard Characters

Goods

Class 28

Gaming machines, namely, devices which accept a wager; Reconfigurable casino and lottery gaming equipment, namely, gaming machines; lottery tickets; lottery cards; scratch cards for playing lottery games

Claims

Priority Filing Date: June 04, 2019, Country or Office: UNITED STATES OF AMERICA, Application No: 88458181 in association with the same kind of goods

Application Number 1,972,377
Language of Application English

Filing Date 2019-06-24

APPLICANT AND AGENT DETAILS

Applicant

IGT
9295 Prototype Drive
Reno, Nevada 89521
UNITED STATES OF AMERICA

Agent

COLLEEN CAISSIE-DUPUIS
(c/o IGT Canada Solutions ULC), 328 Urquhart
Avenue, Moncton, NEW BRUNSWICK,
E1H2R6

TRADEMARK DETAILS

LION DANCE

Trademark Type

Standard Characters

Goods

Class 28

Gaming machines, namely, devices which accept a wager; Reconfigurable casino and lottery gaming equipment, namely, gaming machines; lottery tickets; lottery cards; scratch cards for playing lottery games

Application Number 1,972,378
Language of Application English

Filing Date 2019-06-24

APPLICANT AND AGENT DETAILS

Applicant

IGT
9295 Prototype Drive
Reno, Nevada 89521
UNITED STATES OF AMERICA

Agent

COLLEEN CAISSIE-DUPUIS
(c/o IGT Canada Solutions ULC), 328 Urquhart
Avenue, Moncton, NEW BRUNSWICK,
E1H2R6

TRADEMARK DETAILS

PEAKBARTOP

Trademark Type

Standard Characters

Goods

Class 28

Gaming machines, namely, devices which accept a wager; Reconfigurable casino and lottery gaming equipment, namely, gaming machines and operational computer game software therefor sold as a unit

Claims

Priority Filing Date: June 12, 2019, Country or Office: UNITED STATES OF AMERICA, Application No: 88469933 in association with the same kind of goods

Application Number 1,972,380
Language of Application English

Filing Date 2019-06-24

APPLICANT AND AGENT DETAILS

Applicant

IGT
9295 Prototype Drive
Reno, Nevada 89521
UNITED STATES OF AMERICA

Agent

COLLEEN CAISSIE-DUPUIS
(c/o IGT Canada Solutions ULC), 328 Urquhart
Avenue, Moncton, NEW BRUNSWICK,
E1H2R6

TRADEMARK DETAILS

PEAKCURVE

Trademark Type

Standard Characters

Goods

Class 28

Gaming machines, namely, devices which accept a wager; Reconfigurable casino and lottery gaming equipment, namely, gaming machines and operational computer game software therefor sold as a unit

Claims

Priority Filing Date: June 04, 2019, Country or Office: UNITED STATES OF AMERICA, Application No: 88458189 in association with the same kind of goods

Application Number 1,972,450
Language of Application English

Filing Date 2019-06-24

APPLICANT AND AGENT DETAILS

Applicant

NJOY, LLC
155 6th Ave.
2nd Floor
New York, NY 10013
UNITED STATES OF AMERICA

Agent

BLAKE, CASSELS & GRAYDON LLP
INTELLECTUAL PROPERTY GROUP, SUITE
4000, COMMERCE COURT WEST, 199 BAY
STREET, TORONTO, ONTARIO, M5L1A9

TRADEMARK DETAILS

NJOY ACE

Trademark Type

Standard Characters

Goods

Class 34

Chemical flavorings in liquid form used to refill electronic cigarette cartridges; Electronic cigarette liquid (e-liquid) comprised of flavorings in liquid form, other than essential oils, used to refill electronic cigarette cartridges; Electric cigarettes; Electronic cigarettes; Electronic cigarettes for use as an alternative to traditional cigarettes; Disposable and reusable cartridges sold filled with vaporizable nicotine based liquid solution, for use with battery powered rechargeable portable vaporizing units in the nature of electronic cigarettes and vaporizer pipes

Application Number 1,972,459
Language of Application English

Filing Date 2019-06-24

APPLICANT AND AGENT DETAILS

Applicant

Regeneron Pharmaceuticals, Inc.
777 Old Saw Mill River Road
Tarrytown, NY 10591
UNITED STATES OF AMERICA

Agent

GOWLING WLG (CANADA) LLP
SUITE 1600, 1 FIRST CANADIAN PLACE, 100
KING STREET WEST, TORONTO, ONTARIO,
M5X1G5

TRADEMARK DETAILS

VELOCIHUM

Trademark Type

Standard Characters

Goods

Class 31

Live laboratory animals.

Claims

Priority Filing Date: January 04, 2019, Country or Office: UNITED STATES OF AMERICA,
Application No: 88/250,361 in association with the same kind of goods

Application Number 1,972,462
Language of Application English

Filing Date 2019-06-24

APPLICANT AND AGENT DETAILS

Applicant

Netflix Studios, LLC
5808 W. Sunset Blvd.
Los Angeles, CA 90028
UNITED STATES OF AMERICA

Agent

CLARK WILSON LLP
900 - 885 WEST GEORGIA STREET,
VANCOUVER, BRITISH COLUMBIA, V6C3H1

TRADEMARK DETAILS

SEX/LIFE

Trademark Type

Standard Characters

Services

Class 41

Entertainment services in the nature of a comedic drama television series; providing online non-downloadable video clips and multimedia entertainment recordings containing audio files, video files, artwork, and informational text from and related to a comedic drama television series

Application Number 1,972,463
Language of Application English

Filing Date 2019-06-24

APPLICANT AND AGENT DETAILS

Applicant

Regeneron Pharmaceuticals, Inc.
777 Old Saw Mill River Road
Tarrytown, NY 10591
UNITED STATES OF AMERICA

Agent

GOWLING WLG (CANADA) LLP
SUITE 1600, 1 FIRST CANADIAN PLACE, 100
KING STREET WEST, TORONTO, ONTARIO,
M5X1G5

TRADEMARK DETAILS

VELOCIT

Trademark Type

Standard Characters

Goods

Class 31

Live laboratory animals.

Claims

Priority Filing Date: January 04, 2019, Country or Office: UNITED STATES OF AMERICA,
Application No: 88/250,376 in association with the same kind of goods

Application Number 1,972,561
Language of Application English

Filing Date 2019-06-25

APPLICANT AND AGENT DETAILS

Applicant

Shape Security, Inc.
800 W. El Camino Real, Suite 250
Mountain View, CA 94040
UNITED STATES OF AMERICA

Agent

GOWLING WLG (CANADA) LLP
SUITE 2600, 160 ELGIN STREET, OTTAWA,
ONTARIO, K1P1C3

TRADEMARK DETAILS

Trademark Type

Design

Visual Representation

Authorisation For Use

Consent from Supreme Headquarters Allied Powers Europe is of record

Services

Class 42

Computer software as a service (SAAS) services featuring software for use by others for detecting, monitoring, and preventing network security risks and privacy risks; software as a service (SAAS) services featuring software for use by others featuring software for protecting and securing websites; software as a service (SAAS) services featuring software for use by others featuring software for preventing network attacks and network security breaches; software as a service (SAAS) services, namely, providing machine learning based security and threat detection to users seeking to protect and secure computer systems

Claims

Priority Filing Date: May 23, 2019, Country or Office: UNITED STATES OF AMERICA, Application No: 88/444,380 in association with the same kind of services

Application Number 1,972,580
Language of Application English

Filing Date 2019-06-25

APPLICANT AND AGENT DETAILS

Applicant

BAYER CONSUMER CARE AG
Peter Merian-Straße 84
4052 Basel,
SWITZERLAND

Agent

GOWLING WLG (CANADA) LLP
SUITE 2600, 160 ELGIN STREET, OTTAWA,
ONTARIO, K1P1C3

TRADEMARK DETAILS

UNLEASH THE SCIENCE OF NATURE

Trademark Type

Standard Characters

Goods

Class 05

Throat lozenges; cough syrups; medicated throat spray

Application Number 1,972,582
Language of Application English

Filing Date 2019-06-25

APPLICANT AND AGENT DETAILS

Applicant

Cyclingdeal USA INC.
4532 BROOKS ST
MONTCLAIR, CA 91763
UNITED STATES OF AMERICA

Agent

ANITA MAR
dba Trademark Angel , Suite 521, 6-2557
Dougall Avenue, Windsor, ONTARIO, N8X1T5

TRADEMARK DETAILS

Trademark Type

Design

Visual Representation



Goods

Class 12

bicycle brake lever grips; bicycle chains; bicycle wheels; folding bikes; front forks for cycles; luggage racks for bicycles; mini-bikes

Services

Class 35

On-line retail store services featuring bicycle locks of metal, bicycle parking installations of metal, bicycle assembling machines, bicycle helmets, bicycle safety lights, bicycle speedometers, bicycle reflectors, bicycle training wheels, bicycle brakes, bicycle carriers for vehicles, bicycle chains, bicycle cranks, bicycle cue sheet holders, bicycle gears, bicycle grip tape, bicycle handlebar racks, bicycle handlebars, bicycle horns, bicycle kickstands, bicycle mudguards, bicycle parts, namely, brake shoes, disk wheels, drive chains, drive trains, forks, front fork joints, gear wheels, bicycle pedals, bicycle racks for vehicles, bicycle saddle covers, bicycle seat posts, bicycle seats, bicycle stands, bicycle trailers, bicycle tyres, bicycle wheel hubs, bicycle wheel rims, bicycle wheel spokes, bicycle wheels, fitted bicycle covers, gear levers for bicycle wheels, inner tubes for bicycle tires, pumps for bicycle tires, pumps for bicycle tyres, bicycle storage racks and water bottles

Application Number 1,972,637
Language of Application English

Filing Date 2019-06-21

APPLICANT AND AGENT DETAILS

Applicant

LG Household & Health Care Ltd.
58, Saemunan-ro, Jongno-gu
Seoul,
REPUBLIC OF KOREA

Agent

BORDEN LADNER GERVAIS LLP
World Exchange Plaza, 100 Queen Street,
Suite 1300, Ottawa, ONTARIO, K1P1J9

TRADEMARK DETAILS

Trademark Type

Design

Visual Representation



Goods

Class 03

Cosmetics; skin milk lotions; perfumes; cosmetic cleansing creams; bath soaps; lipsticks; shampoos; eye shadows; dentifrices; hair rinses; hair essence namely, perfumed oils for hair; sunscreen lotions; foundation creams; cheek blush; eye liner; nail polish; cosmetic skin nourishing creams; mask pack for cosmetic purposes; cosmetic body care soaps; lip gloss; massage cream; body lotions; bath gels; shower gels; massage oil; enamel for nails; varnish-removing preparations; cosmetic bath powder; perfumed powder for personal use; hair lotions; body creams; skin cleansing foams; skin cleansing lotions; body cleanser; sun care preparations; nail care preparations; hair care preparations; skin care preparations

Application Number 1,972,803
Language of Application English

Filing Date 2019-06-26

APPLICANT AND AGENT DETAILS

Applicant

ABG-Nine West, LLC
1411 Broadway, Fourth Floor
New York, NY 10018
UNITED STATES OF AMERICA

Agent

GOWLING WLG (CANADA) LLP
SUITE 2600, 160 ELGIN STREET, OTTAWA,
ONTARIO, K1P1C3

TRADEMARK DETAILS

NINE WEST

Trademark Type

Standard Characters

Goods

Class 25

Hats, Scarves and Belts, Gloves, Mittens, Earmuffs and Mufflers.

Application Number 1,972,826
Language of Application English

Filing Date 2019-06-26

APPLICANT AND AGENT DETAILS

Applicant

YM Inc. (Sales)
50 Dufflaw Rd
Toronto
ONTARIO
M6A2W1

Agent

PAUL E. BAIN
(DICKINSON WRIGHT LLP), 199 Bay Street,
Suite 2200, P.O. Box 447, Toronto, ONTARIO,
M5L1G4

TRADEMARK DETAILS

URBAN FUTURE

Trademark Type

Standard Characters

Goods

Class 25

Jeans, sweatshirts, knit tops, shorts, leggings, athletic clothing.

Application Number 1,972,856
Language of Application English

Filing Date 2019-06-26

APPLICANT AND AGENT DETAILS

Applicant

Tommy Bahama Group, Inc.
999 Peachtree Street, N.E.
Suite 688
Atlanta, GA 30309
UNITED STATES OF AMERICA

Agent

GOWLING WLG (CANADA) LLP
SUITE 2600, 160 ELGIN STREET, OTTAWA,
ONTARIO, K1P1C3

TRADEMARK DETAILS

THE COOLEST SPOT IN PARADISE

Trademark Type

Standard Characters

Goods

Class 20

Chairs, outdoor chairs, beach chairs.

Application Number 1,972,986
Language of Application English

Filing Date 2019-06-27

APPLICANT AND AGENT DETAILS

Applicant

IGT
9295 Prototype Drive
Reno, Nevada 89521-8986
UNITED STATES OF AMERICA

Agent

COLLEEN CAISSIE-DUPUIS
(c/o IGT Canada Solutions ULC), 328 Urquhart
Avenue, Moncton, NEW BRUNSWICK,
E1H2R6

TRADEMARK DETAILS

RED HOT JOKER

Trademark Type

Standard Characters

Goods

Class 28

Gaming machines, namely, devices which accept a wager; Reconfigurable casino and lottery gaming equipment, namely, gaming machines; lottery tickets; lottery cards; scratch cards for playing lottery games

Claims

Priority Filing Date: June 19, 2019, Country or Office: UNITED STATES OF AMERICA, Application No: 88479348 in association with the same kind of goods

Application Number 1,972,988
Language of Application English

Filing Date 2019-06-27

APPLICANT AND AGENT DETAILS

Applicant

IGT Global Solutions Corporation
10 Memorial Blvd.
Providence, RI 02903
UNITED STATES OF AMERICA

Agent

COLLEEN CAISSIE-DUPUIS
(c/o IGT Canada Solutions ULC), 328 Urquhart
Avenue, Moncton, NEW BRUNSWICK,
E1H2R6

TRADEMARK DETAILS

Trademark Type

Design

Visual Representation



Services

Class 41

Entertainment services, namely, providing on-line computer games; Entertainment services, namely, providing temporary use of non-downloadable computer games; Providing online non-downloadable game software; Lottery services

Application Number 1,973,224
Language of Application English

Filing Date 2019-06-28

APPLICANT AND AGENT DETAILS

Applicant

Etah Love Ltd.
505 Queen St W
Toronto
ONTARIO
M5V2B4

Agent

WITMART INC.
34 King Street East, Suite 500, Toronto,
ONTARIO, M5C2X8

TRADEMARK DETAILS

ETAH LOVE

Trademark Type

Standard Characters

Goods

Class 14

Bracelets; Earrings; Jewelry rings; Pendants; Sterling silver jewellery; Stainless steel jewelry bracelets

Services

Class 35

Retail sale of jewellery

Application Number 1,973,368
Language of Application English

Filing Date 2019-07-01

APPLICANT AND AGENT DETAILS

Applicant

Shenzhenshi Shen shi jun pin Trading
Company Ltd.
NO.14 XiangkangRoad 302
Shangxing community, Xinqiao Street
Baoan District
Shenzhen,
CHINA

Agent

MILTONS IP/P.I.
15 Fitzgerald Rd, Suite 200, Ottawa,
ONTARIO, K2H9G1

TRADEMARK DETAILS

Trademark Type

Design

Visual Representation

The image shows a stylized, bold, black text logo. The letters are thick and blocky, with a slightly irregular, hand-drawn appearance. The word 'Kaidvll' is written in a single line. The 'K' is the largest and most prominent letter, followed by 'a', 'i', 'd', 'v', 'l', and 'l'. The 'i' has a small dot above it. The 'v' is a simple, downward-pointing shape. The two 'l's are vertical bars with a small hook at the bottom.

Goods

Class 25

ties;ascots;pocket squares;girdles;Belts;money belts;suspenders;caps;Hat;Shirts;Scarfs;shawls;T-shirts;Trousers;Skirts;gloves;Berets

Application Number 1,973,451
Language of Application English

Filing Date 2019-07-02

APPLICANT AND AGENT DETAILS

Applicant

L'Oréal (UK) Limited
255 Hammersmith Road
London, W6 8AZ
UNITED KINGDOM

Agent

FASKEN MARTINEAU DUMOULIN LLP
Tour de la Bourse, Suite 3500, P.O. box 242,
800, Place Victoria, Montréal, QUEBEC,
H4Z1E9

TRADEMARK DETAILS

SATIN CRUSH

Trademark Type

Standard Characters

Goods

Class 03

Makeup preparations.

Claims

Priority Filing Date: May 02, 2019, Country or Office: UNITED KINGDOM, Application No: UK00003396614 in association with the same kind of goods

Application Number 1,973,461
Language of Application English

Filing Date 2019-07-02

APPLICANT AND AGENT DETAILS

Applicant

Mastronardi Produce Ltd.
c/o Dinsmore & Shohl LLP
900 Wilshire Drive, Suite 300
Troy, MI 48084
UNITED STATES OF AMERICA

Agent

RIDOUT & MAYBEE LLP
5500 North Service Road, Suite 101,
Burlington, ONTARIO, L7L6W6

TRADEMARK DETAILS

HONEY BOMBS

Trademark Type

Standard Characters

Goods

Class 31

Fresh fruits and vegetables

Application Number 1,973,469
Language of Application English

Filing Date 2019-07-02

APPLICANT AND AGENT DETAILS

Applicant

PBM Nutritionals, LLC
652 Peter Jefferson Parkway, Suite 300
Charlottesville, Virginia 22911
UNITED STATES OF AMERICA

Agent

GOWLING WLG (CANADA) LLP
SUITE 1600, 1 FIRST CANADIAN PLACE, 100
KING STREET WEST, TORONTO, ONTARIO,
M5X1G5

TRADEMARK DETAILS

REVIVER

Trademark Type

Standard Characters

Goods

Class 05

Electrolyte replacement solutions;

Claims

Priority Filing Date: February 01, 2019, Country or Office: UNITED STATES OF AMERICA,
Application No: 88286406 in association with the same kind of goods

Application Number 1,973,472
Language of Application English

Filing Date 2019-07-02

APPLICANT AND AGENT DETAILS

Applicant

Iterum Therapeutics International Limited
Block 2 Floor 3 Harcourt Centre
Harcourt Street
Dublin 2
IRELAND

Agent

GILBERT'S LLP
77 King St W, Suite 2010, P.O. Box 301,
Toronto-Dominion Centre, Toronto, ONTARIO,
M5K1K2

TRADEMARK DETAILS

IVVELIAH

Trademark Type
Standard Characters

Goods

Class 05

Pharmaceutical preparations, namely antibiotics

Application Number 1,973,473
Language of Application English

Filing Date 2019-07-02

APPLICANT AND AGENT DETAILS

Applicant

Iterum Therapeutics International Limited
Block 2 Floor 3 Harcourt Centre
Harcourt Street
Dublin 2
IRELAND

Agent

GILBERT'S LLP
77 King St W, Suite 2010, P.O. Box 301,
Toronto-Dominion Centre, Toronto, ONTARIO,
M5K1K2

TRADEMARK DETAILS

OEDIVLA

Trademark Type

Standard Characters

Goods

Class 05

Pharmaceutical preparations, namely antibiotics

Application Number 1,973,570
Language of Application English

Filing Date 2019-07-02

APPLICANT AND AGENT DETAILS

Applicant

Faipa Cosmetics S.r.l.
Via Vaccareccia 11
00040 Pomezia (Roma),
ITALY

Agent

ROBIC
630, boul. René-Lévesque Ouest, 20e étage,
Montréal, QUEBEC, H3B1S6

TRADEMARK DETAILS

NYO

Trademark Type

Standard Characters

Goods

Class 03

Hair conditioners; hair dyes; hair lotions; hair spray; hair straightening preparations; hair waving preparations; cosmetic creams; shampoos; soap for body care; natural and synthetic perfumery; cosmetics; color-removing preparations for hair; make-up removing preparations; nail care preparations.

Application Number 1,973,577
Language of Application English

Filing Date 2019-07-02

APPLICANT AND AGENT DETAILS

Applicant

ROBERN, INC.
701 North Wilson Ave.
Bristol, PA 19007
UNITED STATES OF AMERICA

Agent

MCMILLAN LLP
BROOKFIELD PLACE, SUITE 4400, BAY
WELLINGTON TOWER, 181 BAY STREET,
TORONTO, ONTARIO, M5J2T3

TRADEMARK DETAILS

SCULPT

Trademark Type

Standard Characters

Goods

Class 20

Lighted mirrors

Application Number 1,973,578
Language of Application English

Filing Date 2019-07-02

APPLICANT AND AGENT DETAILS

Applicant

ROBERN, INC.
701 North Wilson Avenue
Bristol, PA 19007
UNITED STATES OF AMERICA

Agent

MCMILLAN LLP
BROOKFIELD PLACE, SUITE 4400, BAY
WELLINGTON TOWER, 181 BAY STREET,
TORONTO, ONTARIO, M5J2T3

TRADEMARK DETAILS

ILLUSTRATE

Trademark Type

Standard Characters

Goods

Class 20

Lighted mirrors

Application Number 1,973,593
Language of Application English

Filing Date 2019-07-02

APPLICANT AND AGENT DETAILS

Applicant

GIORGIO ARMANI S.P.A.
Via Borgonuovo 11
20121 Milano,
ITALY

Agent

GOWLING WLG (CANADA) LLP
SUITE 2600, 160 ELGIN STREET, OTTAWA,
ONTARIO, K1P1C3

TRADEMARK DETAILS

Trademark Type

Design

Visual Representation

GARDENIA
ANTIGUA

ARMANI / PRIVE

Goods

Class 03

Perfumes; eaux de toilette

Claims

Priority Filing Date: June 11, 2019, Country or Office: EUIPO (EU), Application No: 018080609 in association with the same kind of goods

Application Number 1,973,677
Language of Application English

Filing Date 2019-07-03

APPLICANT AND AGENT DETAILS

Applicant

MAGIC BOX INT. TOYS, S.L.U
Pl. Xavier Cugat 2, Edifici D, Pl. 2 A
08174 - SANT CUGAT DEL VALLÈS
(Barcelona),
SPAIN

Agent

ROBIC
630, boul. René-Lévesque Ouest, 20e étage,
Montréal, QUEBEC, H3B1S6

TRADEMARK DETAILS

SUPERTHINGS RIVALS OF KABOOM

Trademark Type

Standard Characters

Goods

Class 28

Games, namely, toy figures; Board games; Game boards for trading card games; Video game machines; Toys, namely, children's multiple activity toy; Children's playthings, namely, infant toys; Mechanical action toys; Plush toys; Dolls.

Application Number 1,973,707
Language of Application English

Filing Date 2019-07-03

APPLICANT AND AGENT DETAILS

Applicant

Barefoot Dreams, Inc.
5302 Derry Ave, Unit D
Agoura Hills, CA 91301
UNITED STATES OF AMERICA

Agent

MARKS & CLERK
33 Yonge Street, , Suite 300, Toronto,
ONTARIO, M5E1G4

TRADEMARK DETAILS

Trademark Type

Design

Visual Representation

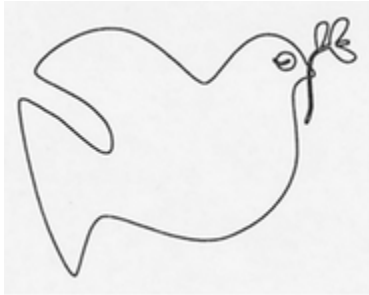

Goods

Class 04

(1) Candles

Class 24

(2) Baby bedding, namely, bundle bags, swaddling blankets, crib bumpers, fitted crib sheets, crib skirts, crib blankets, and diaper changing pad covers not of paper; Bed throws; Children's blankets; Receiving blankets; Throws

Class 25

(3) Hoodies; Pajamas; Pants; Pullovers; T-shirts

Application Number 1,973,748
Language of Application English

Filing Date 2019-07-03

APPLICANT AND AGENT DETAILS

Applicant

PERFECT AIRE LLC
1209 Orange Street
Wilmington, DE 19801
UNITED STATES OF AMERICA

Agent

GOWLING WLG (CANADA) LLP
SUITE 2600, 160 ELGIN STREET, OTTAWA,
ONTARIO, K1P1C3

TRADEMARK DETAILS

Trademark Type

Design

Visual Representation



Goods

Class 11

Dehumidifiers; dehumidifiers for household purposes; dehumidifiers for household use; desiccating units for household purposes and use, namely, desiccating units for removing water from the air in dehumidification systems

Application Number 1,973,806
Language of Application English

Filing Date 2019-07-03

APPLICANT AND AGENT DETAILS

Applicant

LG Household & Health Care Ltd.
58, Saemunan-ro, Jongno-gu
Seoul,
REPUBLIC OF KOREA

Agent

BORDEN LADNER GERVAIS LLP
World Exchange Plaza, 100 Queen Street,
Suite 1300, Ottawa, ONTARIO, K1P1J9

TRADEMARK DETAILS

CICAPEPTITE

Trademark Type

Standard Characters

Goods

Class 03

Cosmetics; skin milk lotions; perfumes; cosmetic cleansing creams; bath soaps; lipsticks; shampoos; eye shadows; dentifrices; hair rinses; hair essence namely, perfumed oils for hair; sunscreen lotions; foundation creams; cheek blush; eye liner; nail polish; cosmetic skin nourishing creams; mask pack for cosmetic purposes; cosmetic body care soaps; lip gloss; massage cream; body lotions; bath gels; shower gels; massage oil; enamel for nails; varnish-removing preparations; cosmetic bath powder; perfumed powder for personal use; hair lotions; body creams; skin cleansing foams; skin cleansing lotions; body cleanser; sun care preparations; nail care preparations; hair care preparations; skin care preparations

Application Number 1,973,813
Language of Application English

Filing Date 2019-07-03

APPLICANT AND AGENT DETAILS

Applicant

Novatek Corporation
700 Shell Lane
Phoenixville, Pennsylvania 19460
UNITED STATES OF AMERICA

Agent

FASKEN MARTINEAU DUMOULIN LLP
2900 - 550 BARRARD STREET,
VANCOUVER, BRITISH COLUMBIA, V6C0A3

TRADEMARK DETAILS

AIRGANICS

Trademark Type

Standard Characters

Goods

Class 11

Air purifying units; air scrubbing machines for industrial and commercial use in the nature of greenhouse installations, indoor agriculture and food processing facilities; filters for air purifying units and for air scrubbing machines for industrial and commercial use in the nature of greenhouse installations, indoor agriculture and food processing facilities;

Application Number 1,973,981
Language of Application English

Filing Date 2019-07-05

APPLICANT DETAILS

Applicant

BEIJING MEI ZHOU DONG PO RESTAURANT
No.4, Yinghuadong Street, Chaoyang District
100020 Beijing,
CHINA

TRADEMARK DETAILS

Trademark Type

Design

Visual Representation



眉州东坡
MEI ZHOU DONG PO

Foreign Character Translation

As provided by the Applicant, the English translation of the foreign characters contained in the subject mark is EYEBROW; STATE; EAST; SLOPE.

Foreign Character Transliteration

As provided by the Applicant, the Latin transliteration of the foreign characters contained in the subject mark is MEI; ZHOU; DONG; PO.

Goods

Class 29

(1) Pork; Meat; Ham; Sausages; Salted fish; Tinned meat; Preserved fruit and vegetables; Pickles; Eggs; Edible oils.

Class 30

(2) Tea; Baozi [stuffed buns]; Pastries; Cereal-based snack food; Flour for food; Noodles; Seasonings; Chutney condiments; Pepper; Soya bean paste condiment.

Services

Class 43

Food and drink catering; Cafeteria services; Canteen services; Hotels; Restaurants; Self-service restaurants; Snack-bars; Bar services; Tea rooms; Catering services.

Application Number 1,974,135
Language of Application English

Filing Date 2019-07-05

APPLICANT AND AGENT DETAILS

Applicant

We Clean You Shine Incorporated
12 Shortill Road
Ballinafad
ONTARIO
N0B1H0

Agent

CHANTAL ST. DENIS
(O'BRIEN TM SERVICES INC), 262, chemin
Eardley, Gatineau, QUEBEC, J9J2Y7

TRADEMARK DETAILS

CLEAN SHINE

Trademark Type

Standard Characters

Services

Class 37

Janitorial and housekeeping services

Application Number 1,974,137
Language of Application English

Filing Date 2019-07-05

APPLICANT AND AGENT DETAILS

Applicant

We Clean You Shine Incorporated
12 Shortill Road
Ballinafad
ONTARIO
N0B1H0

Agent

CHANTAL ST. DENIS
(O'BRIEN TM SERVICES INC), 262, chemin
Eardley, Gatineau, QUEBEC, J9J2Y7

TRADEMARK DETAILS

WE CLEAN...YOU SHINE

Trademark Type

Standard Characters

Services

Class 37

Janitorial and housekeeping services

Application Number 1,974,199
Language of Application English

Filing Date 2019-07-05

APPLICANT AND AGENT DETAILS

Applicant

ZURU (Singapore) Pte. Ltd
1003, BUKIT MERAH CENTRAL
#06-07, SINGAPORE 159836
SINGAPORE

Agent

BENOÎT & CÔTÉ INC.
560 boul. Crémazie Est, 3e étage, Montréal,
QUEBEC, H2P1E8

TRADEMARK DETAILS

HEALTH BY HABIT

Trademark Type

Standard Characters

Goods

Class 05

Nutritional supplements for general health and well-being, dietary supplements for general health and well-being.

Application Number 1,974,234
Language of Application English

Filing Date 2019-07-05

APPLICANT AND AGENT DETAILS

Applicant

Denis Michel Leblanc, doing business as NO6
COFFEE
511 Front Street
Nelson
BRITISH COLUMBIA
V1L4B4

Agent

MCMILLAN LLP
1500 - 1055 WEST GEORGIA STREET, P.O.
BOX 11117, ROYAL CENTRE, VANCOUVER,
BRITISH COLUMBIA, V6E4N7

TRADEMARK DETAILS

Trademark Type
Design

Visual Representation



NO6
COFFEE CO.

Goods

Class 30

coffee; coffee based beverages

Services

Class 35

retail and wholesale sales of coffee

Application Number 1,974,235
Language of Application English

Filing Date 2019-07-05

APPLICANT AND AGENT DETAILS

Applicant

Denis Michel Leblanc, doing business as NO6
COFFEE
511 Front Street
Nelson
BRITISH COLUMBIA
V1L4B4

Agent

MCMILLAN LLP
1500 - 1055 WEST GEORGIA STREET, P.O.
BOX 11117, ROYAL CENTRE, VANCOUVER,
BRITISH COLUMBIA, V6E4N7

TRADEMARK DETAILS

NO6 COFFEE CO.

Trademark Type

Standard Characters

Goods

Class 30

coffee; coffee based beverages

Services

Class 35

retail and wholesale sales of coffee

Application Number 1,974,238
Language of Application English

Filing Date 2019-07-05

APPLICANT AND AGENT DETAILS

Applicant

Lighthouse A One Franchising Ltd.
PO Box 2667 Clearbrook Station
Abbotsford
BRITISH COLUMBIA
V2T6R4

Agent

GOWLING WLG (CANADA) LLP
550 BURRARD STREET, SUITE 2300,
VANCOUVER, BRITISH COLUMBIA, V6C2B5

TRADEMARK DETAILS

LIGHTHOUSE INDIAN KITCHEN

Trademark Type

Standard Characters

Services

Class 43

restaurant services; carry-out restaurant services; business catering services; restaurants featuring online ordering

Application Number 1,974,239
Language of Application English

Filing Date 2019-07-05

APPLICANT AND AGENT DETAILS

Applicant

Lighthouse A One Franchising Ltd.
PO Box 2667 Clearbrook Station
Abbotsford
BRITISH COLUMBIA
V2T6R4

Agent

GOWLING WLG (CANADA) LLP
550 BURRARD STREET, SUITE 2300,
VANCOUVER, BRITISH COLUMBIA, V6C2B5

TRADEMARK DETAILS

Trademark Type

Design

Visual Representation



INDIAN KITCHEN

Services

Class 43

restaurant services; carry-out restaurant services; business catering services; restaurants featuring online ordering

Application Number 1,974,297
Language of Application English

Filing Date 2019-07-08

APPLICANT AND AGENT DETAILS

Applicant

Bayer Aktiengesellschaft

Kaiser-Wilhelm-Allee
51373 Leverkusen,
GERMANY

Agent

GOWLING WLG (CANADA) LLP
SUITE 2600, 160 ELGIN STREET, OTTAWA,
ONTARIO, K1P1C3

TRADEMARK DETAILS

STRYAX

Trademark Type

Standard Characters

Goods

Class 05

Preparations for destroying vermin; fungicides, herbicides

Application Number 1,974,298
Language of Application English

Filing Date 2019-07-08

APPLICANT AND AGENT DETAILS

Applicant

Bayer Aktiengesellschaft
Kaiser-Wilhelm-Allee
51373 Leverkusen,
GERMANY

Agent

GOWLING WLG (CANADA) LLP
SUITE 2600, 160 ELGIN STREET, OTTAWA,
ONTARIO, K1P1C3

TRADEMARK DETAILS

GALDRON

Trademark Type

Standard Characters

Goods

Class 05

Preparations for destroying vermin; fungicides, herbicides

Application Number 1,974,449
Language of Application English

Filing Date 2019-07-08

APPLICANT AND AGENT DETAILS

Applicant

The Trustees of the Fiducie Corporative B. Da
Silva
920-1470 Rue Peel
Montréal
QUEBEC
H3A1T1

Agent

TIGER BANON INC.
716-1010 Rue Sherbrooke O, Montréal,
QUEBEC, H3A2R7

TRADEMARK DETAILS

ROSETTI

Trademark Type

Standard Characters

Services

Class 35

(1) operation of a bakery

Class 43

(2) restaurant services

Application Number 1,974,537
Language of Application English

Filing Date 2019-07-09

APPLICANT AND AGENT DETAILS

Applicant

e-Fibres LLC
2330 Ponce de leon bvd
Coral Gables, FL 33134
UNITED STATES OF AMERICA

Agent

DJB
500 Boulevard Gouin E, Suite 302, Montréal,
QUEBEC, H3L3R9

TRADEMARK DETAILS

Trademark Type

Design

Visual Representation



Goods

Class 23

Yarns; Knitting yarns.

Claims

Priority Filing Date: January 15, 2019, Country or Office: UNITED STATES OF AMERICA,
Application No: 88261652 in association with the same kind of goods

Application Number 1,974,548
Language of Application English

Filing Date 2019-07-09

APPLICANT AND AGENT DETAILS

Applicant

Dan Le
1396 Falconridge Dr NE
Calgary
ALBERTA
T3J1J2

Agent

TRADEMARK FACTORY INTERNATIONAL
INC.
300 - 1055 W. Hastings St. , Vancouver,
BRITISH COLUMBIA, V6E2E9

TRADEMARK DETAILS

ESCAPE OPS

Trademark Type

Standard Characters

Services

Class 41

Entertainment services in the nature of escape rooms

Application Number 1,974,565
Language of Application English

Filing Date 2019-07-09

APPLICANT AND AGENT DETAILS

Applicant

Two Pine Ventures Inc.
27 Balsam Ave, Unit 1
Bragg Creek
ALBERTA
T0L0K0

Agent

FIELD LLP
400-444 7 Avenue SW, Calgary, ALBERTA,
T2P0X8

TRADEMARK DETAILS

PURE AS POW

Trademark Type

Standard Characters

Goods

Class 33

vodka, vodka cocktails, alcoholic coolers, aperitifs with a distilled alcoholic liquor base

Application Number 1,974,567
Language of Application English

Filing Date 2019-07-09

APPLICANT AND AGENT DETAILS

Applicant

SnoDay Brands Inc.
27 Balsam Ave., Unit 4
Bragg Creek
ALBERTA
T0L0K0

Agent

FIELD LLP
400-444 7 Avenue SW, Calgary, ALBERTA,
T2P0X8

TRADEMARK DETAILS

SNODAY

Trademark Type

Standard Characters

Goods

Class 33

vodka, vodka cocktails, gin, gin cocktails, alcoholic coolers, aperitifs with a distilled alcoholic liquor base

Application Number 1,974,568
Language of Application English

Filing Date 2019-07-09

APPLICANT AND AGENT DETAILS

Applicant

SnoDay Brands Inc.
27 Balsam Ave., Unit 4
Bragg Creek
ALBERTA
T0L0K0

Agent

FIELD LLP
400-444 7 Avenue SW, Calgary, ALBERTA,
T2P0X8

TRADEMARK DETAILS

Trademark Type

Design

Visual Representation



Goods

Class 33

vodka, vodka cocktails, gin, gin cocktails, alcoholic coolers, aperitifs with a distilled alcoholic liquor base

Application Number 1,974,616
Language of Application English

Filing Date 2019-07-09

APPLICANT AND AGENT DETAILS

Applicant

LG HOUSEHOLD & HEALTH CARE LTD.
58 Saemunan-ro, Jongno-gu
Seoul,
REPUBLIC OF KOREA

Agent

NORTON ROSE FULBRIGHT CANADA LLP/S.
E.N.C.R.L.,S.R.L.
1, Place Ville Marie, Suite 2500, Montreal,
QUEBEC, H3B1R1

TRADEMARK DETAILS

Ianiheal

Trademark Type

Standard Characters

Goods

Class 03

Cosmetics; skin milk lotions; perfumes; colognes; eau de toilette; body mist; perfumes in solid form; perfumed soap; perfumed powder; fragrances for personal use; cosmetic cleansing creams; bath soaps; lipsticks; shampoos; eye shadows; dentifrices; hair rinses; hair essence namely, perfumed oils for hair; sunscreen lotions; foundation creams; cheek blush; eye liner; nail polish; cosmetic skin nourishing creams; mask pack for cosmetic purposes; cosmetic body care soaps; lip gloss; massage cream; body lotions; bath gels; shower gels; massage oil; enamel for nails; varnish-removing preparations; cosmetic bath powder; perfumed powder for personal use; hair lotions; body creams; skin cleansing foams; skin cleansing lotions; body cleanser; sun care preparations; nail care preparations; hair care preparations; skin care preparations

Application Number 1,974,647
Language of Application English

Filing Date 2019-07-09

APPLICANT AND AGENT DETAILS

Applicant

BANDAI NAMCO Entertainment Inc.
5-37-8 Shiba, Minato-ku
Tokyo 108-0014,
JAPAN

Agent

GOWLING WLG (CANADA) LLP
SUITE 2600, 160 ELGIN STREET, OTTAWA,
ONTARIO, K1P1C3

TRADEMARK DETAILS

Trademark Type

Design

Visual Representation

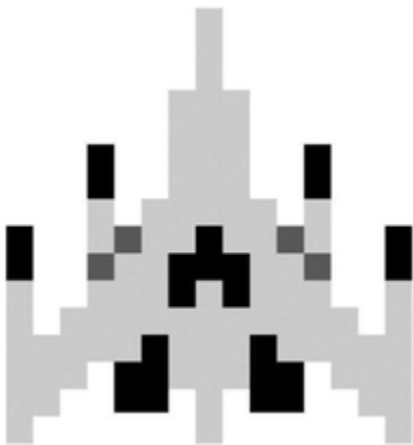

Goods

Class 09

Downloadable computer game programs; Downloadable computer game software via a global computer network and wireless devices

Claims

Priority Filing Date: January 28, 2019, Country or Office: UNITED STATES OF AMERICA,
Application No: 88/278,510 in association with the same kind of goods

Application Number 1,974,704
Language of Application English

Filing Date 2019-07-09

APPLICANT AND AGENT DETAILS

Applicant

Mondetta Canada, Inc.
1109 Winnipeg Avenue
Winnipeg
MANITOBA
R3E0S2

Agent

MLT AIKINS LLP
2100 Livingston Place, 222-3rd Avenue SW,
Calgary, ALBERTA, T2P0B4

TRADEMARK DETAILS

SOUL & SKY

Trademark Type

Standard Characters

Goods

Class 25

clothing, namely, pants, shirts, hats, jackets, jeans, shorts, socks, sweaters, sweatpants, sweatshirts, T-shirts, tank tops, belts, underwear, sandals, shoes, slippers;

Application Number 1,974,727
Language of Application English

Filing Date 2019-07-10

APPLICANT AND AGENT DETAILS

Applicant

Delta Faucet Company
55 East 111th Street
Indianapolis, IN 46280
UNITED STATES OF AMERICA

Agent

PIASETZKI NENNIGER KVAS LLP
SUITE 2308, 120 ADELAIDE STREET WEST,
TORONTO, ONTARIO, M5H1T1

TRADEMARK DETAILS

VENUTO

Trademark Type

Standard Characters

Foreign Character Translation

As provided by the applicant, the English translation of the Italian word VENUTO is "come".

Goods

Class 11

Plumbing products, namely faucets

Application Number 1,974,754
Language of Application English

Filing Date 2019-07-10

APPLICANT AND AGENT DETAILS

Applicant

Spinal Elements, Inc.
3115 Melrose Drive
Suite 200
Carlsbad, CA 92010
UNITED STATES OF AMERICA

Agent

PERRY + CURRIER
1300 YONGE STREET, SUITE 500,
TORONTO, ONTARIO, M4T1X3

TRADEMARK DETAILS

INCORPORATE

Trademark Type

Standard Characters

Goods

Class 10

Medical devices, namely, spinal implants composed of artificial materials.

Claims

Priority Filing Date: January 18, 2019, Country or Office: UNITED STATES OF AMERICA,
Application No: 88268019 in association with the same kind of goods

Application Number 1,974,758
Language of Application English

Filing Date 2019-07-10

APPLICANT AND AGENT DETAILS

Applicant

Crown Property Management Inc.
400 University Avenue, Suite 1900
Toronto
ONTARIO
M5G1S5

Agent

NELLIGAN O'BRIEN PAYNE LLP
300-50 O'CONNOR STREET, OTTAWA,
ONTARIO, K1P6L2

TRADEMARK DETAILS

DIFFERENCE IS OUR DIFFERENCE

Trademark Type

Standard Characters

Services

Class 36

(1) Commercial real estate leasing; acquisition of real estate for others; real estate brokerage; real estate management services; real estate investment

Class 37

(2) Real estate development

Application Number 1,974,792
Language of Application English

Filing Date 2019-07-10

APPLICANT AND AGENT DETAILS

Applicant

Colgate-Palmolive Canada Inc.
Two Morneau Sobeco Centre, 6th Floor
895 Don Mills Road
Toronto
ONTARIO
M3C1W3

Agent

SMART & BIGGAR LLP
1100-150 York street, TORONTO, ONTARIO,
M5H3S5

TRADEMARK DETAILS

PLAQLESS

Trademark Type

Standard Characters

Goods

Class 09

(1) Downloadable computer software and mobile application software for use in tracking, processing, and displaying oral hygiene data and educating consumers in the field of oral hygiene

Class 21

(2) Toothbrushes

Application Number 1,974,850
Language of Application English

Filing Date 2019-07-10

APPLICANT AND AGENT DETAILS

Applicant

Shakespeare All Star Acquisition LLC
7 Science Court
Columbia, SC 29203
UNITED STATES OF AMERICA

Agent

GOWLING WLG (CANADA) LLP
SUITE 1600, 1 FIRST CANADIAN PLACE, 100
KING STREET WEST, TORONTO, ONTARIO,
M5X1G5

TRADEMARK DETAILS

HI-LITE

Trademark Type

Standard Characters

Goods

Class 28

Fishing rods; fishing reels; fishing rods and fishing reels provided in combination

Claims

Priority Filing Date: July 09, 2019, Country or Office: UNITED STATES OF AMERICA, Application No: 88/506,223 in association with the same kind of goods

Application Number 1,974,862
Language of Application English

Filing Date 2019-07-10

APPLICANT AND AGENT DETAILS

Applicant

Horst Neumann
6187 Scott Road
Duncan
BRITISH COLUMBIA
V9L6Y8

Agent

MBM INTELLECTUAL PROPERTY LAW LLP
275 SLATER STREET, 14TH FLOOR,
OTTAWA, ONTARIO, K1P5H9

TRADEMARK DETAILS

CAPTAIN

Trademark Type
Standard Characters

Goods

Class 06

Metal debris guards for gutters

Application Number 1,974,874
Language of Application English

Filing Date 2019-07-10

APPLICANT AND AGENT DETAILS

Applicant

Hunter Douglas Inc.
1 Blue Hill Plaza
20th Floor
Pearl River, NY 10965
UNITED STATES OF AMERICA

Agent

GOWLING WLG (CANADA) LLP
SUITE 2600, 160 ELGIN STREET, OTTAWA,
ONTARIO, K1P1C3

TRADEMARK DETAILS

SOLARTILT

Trademark Type

Standard Characters

Goods

Class 20

interior window blinds; interior window shades

Application Number 1,974,989
Language of Application English

Filing Date 2019-06-14

APPLICANT AND AGENT DETAILS

Applicant

SALT FINE JEWELRY INC.
190 Roslin Avenue
Toronto
ONTARIO
M4N1Z6

Agent

LOOPSTRA NIXON LLP
WOODBINE PLACE, 135 QUEENS PLATE
DRIVE, SUITE 600, TORONTO, ONTARIO,
M9W6V7

TRADEMARK DETAILS

SALT STYLE

Trademark Type

Standard Characters

Goods

Class 04

(1) Candle.

Class 14

(2) Jewelry.

Application Number 1,975,029
Language of Application English

Filing Date 2019-07-11

APPLICANT AND AGENT DETAILS

Applicant

SUMITOMO RUBBER INDUSTRIES, LTD.
6-9, Wakinohama-cho 3-chome
Chuo-ku Kobe-shi
Hyogo, 651-0072
JAPAN

Agent

MACRAE & CO.
326 Somerset Street West, Ottawa, ONTARIO,
K2P0J9

TRADEMARK DETAILS

DRAGMAX

Trademark Type

Standard Characters

Goods

Class 12

Tires for vehicles; tires for two-wheeled motor vehicles; tires for motorcycles

Application Number 1,975,084
Language of Application English

Filing Date 2019-07-11

APPLICANT AND AGENT DETAILS

Applicant

IGG Singapore Pte. Ltd., a legal entity
80 Pasir Panjang Road
#18-84, Mapletree Business City,
Singapore 117372,
SINGAPORE

Agent

RICHEs, MCKENZIE & HERBERT LLP
SUITE 1800, 2 BLOOR STREET EAST,
TORONTO, ONTARIO, M4W3J5

TRADEMARK DETAILS

Empire Evolution

Trademark Type

Standard Characters

Goods

Class 09

Computer games downloadable from a global computer network; Computer games for use on mobile and cellular phones; Downloadable computer games; Downloadable electronic games; Downloadable electronic games for use with mobile telephones, handheld computers and tablet computers; Computer video games downloaded via the internet; Computer video games; Computer game cartridges; Recorded computer operating programs; Interactive multimedia computer games; Software for creating virtual reality games; Pre-recorded compact discs containing computer games; Computer software for computer-aided design/computer-aided manufacturing [CAD/CAM]; Computers; Computer hardware; Downloadable electronic publications in the nature of magazines

Services

Class 41

Providing on-line computer games; Online video gaming services; Providing a website featuring on-line computer games and information about computer games; Rental of computer games; Electronic publishing services, namely, publication of text and graphic works of others on-line featuring computer games

Application Number 1,975,102
Language of Application English

Filing Date 2019-07-11

APPLICANT AND AGENT DETAILS

Applicant

FGX International Inc.
500 George Washington Highway
Smithfield, RI 02917
UNITED STATES OF AMERICA

Agent

RIDOUT & MAYBEE LLP
11 Holland Avenue, Suite 601 , Ottawa,
ONTARIO, K1Y4S1

TRADEMARK DETAILS

EZ2C

Trademark Type

Standard Characters

Goods

Class 09

Eyewear, namely, spectacles, eyeglasses, reading glasses, sunglasses, contact lenses, eyeglass lenses, eyeglass frames, optical frames, cases for reading glasses, and accessories related thereto, namely, cases, chains, neck cords, lanyards.

Application Number 1,975,185
Language of Application English

Filing Date 2019-07-12

APPLICANT DETAILS

Applicant

Nufarm Americas Inc.
11901 South Austin Avenue
Alsip, IL 60803
UNITED STATES OF AMERICA

TRADEMARK DETAILS

BLACKOUT

Trademark Type

Standard Characters

Goods

Class 05

Pesticides, fungicides, herbicides, insecticides, biocides, nematicides and parasiticides

Application Number 1,975,264
Language of Application English

Filing Date 2019-07-12

APPLICANT AND AGENT DETAILS

Applicant

The Procter & Gamble Company
One Procter & Gamble Plaza
Cincinnati, OH 45202
UNITED STATES OF AMERICA

Agent

WILSON LUE LLP
250 University Avenue, 5th Floor, Toronto,
ONTARIO, M5H3E5

TRADEMARK DETAILS

RINSE SHIELD

Trademark Type

Standard Characters

Goods

Class 03

automatic dishwashing detergent

Application Number 1,975,372
Language of Application English

Filing Date 2019-07-15

APPLICANT DETAILS

Applicant

Dongguan Ku Yue Dian Zi Technology Co.,
Limited
3/F, 130 Nancheng Avenue, Xuzhen
Community
Zhangmutou Town
Dongguan,
CHINA

TRADEMARK DETAILS

Trademark Type

Design

Visual Representation



Goods

Class 09

headphones; cases adapted for computers; cases for mobile phones; cell phone battery chargers for use in vehicles; computer cables; data cables; digital music players; digital video players; earphones; electric plugs; electric sockets; flash memory cards; general purpose batteries; loud speakers; mobile telephone battery chargers for use in vehicles; portable telephones; protective films adapted for smartphone screens; selfie stick; smartwatches; stands for mobile phones; usb chargers; usb flash drives; wearable activity trackers;

Application Number 1,975,431
Language of Application English

Filing Date 2019-07-15

APPLICANT AND AGENT DETAILS

Applicant

HAUSBRANDT TRIESTE 1892 SPA
Via Foscarini 52
31040 Nervesa della Battaglia (TV),
ITALY

Agent

MARKS & CLERK
180 Kent Street, Suite 1900, Ottawa,
ONTARIO, K1P0B6

TRADEMARK DETAILS

Trademark Type

Design

Visual Representation



HAUSBRANDT

TRIESTE 1892

Goods

Class 30

Coffee, tea, cocoa; sugar and honey; coffee beverage flavorings; artificial coffee; coffee-based beverages; cocoa-based beverages; barley tea; honey; crushed barley; ground barley; non-alcoholic chocolate-based beverages; waffles; chocolate; vegetal preparations for use as coffee substitutes; biscuits; tea infusions; herbal tea infusions; fruit tea infusions, nonmedical herbal teas, fruit-based infusions, aromatic preparations for making non-medicated infusions, fruit flavoured tea, other than, medicinal, tisanes namely herbal tea beverages.

Services

Class 35

Layout services for advertising purposes; advertising services for the promotion of production for others, in relation to coffee, tea, cocoa, sugar and honey, coffee flavorings, artificial coffee, coffee-based beverages, tea-based beverages, cocoa-based beverages, barley drinks, honey, crushed barley, ground barley, drinking chocolate, waffles, chocolate, vegetal preparations for use as coffee substitutes, biscuits, infusions, not medicinal, non medical herbal teas, fruit-based infusions, aromatic preparations for making non medicated infusions, fruit flavoured tea, other than medicinal, tisanes; direct mail advertising for others, namely leaflets, prospectuses, printed material, samples; publication of publicity texts; on-line advertising services for others on a computer internet network; writing of publicity texts; on-line retail services of products in relation to

coffee, tea, cocoa, sugar and honey, coffee flavorings, artificial coffee, coffee-based beverages, tea-based beverages, cocoa-based beverages, barley drinks, honey, crushed barley, ground barley, drinking chocolate, waffles, chocolate, vegetal preparations for use as coffee substitutes, biscuits, infusions, not medicinal, nonmedical herbal teas, fruit-based infusions, aromatic preparations for making non-medicated infusions, fruit flavoured tea, other than medicinal, tisanes; retailing or wholesaling of products in relation to coffee, tea, cocoa, sugar and honey, coffee flavorings, artificial coffee, coffee-based beverages, tea-based beverages, cocoa-based beverages, barley drinks, honey, crushed barley, ground barley, drinking chocolate, waffles, chocolate, vegetal preparations for use as coffee substitutes, biscuits, infusions, not medicinal, non-medical herbal teas, fruit-based infusions, aromatic preparations for making non-medicated infusions, fruit flavoured tea, other than medicinal, tisanes; franchising services, namely, consultancy support in the management and organisation of restaurants, bars, cafeterias; retail shop window display arrangement services.

Claims

Priority Filing Date: March 12, 2019, Country or Office: ITALY, Application No: 302019000017603 in association with the same kind of services; March 12, 2019, Country or Office: ITALY, Application No: 302019000017603 in association with the same kind of goods

Application Number 1,975,451
Language of Application English

Filing Date 2019-07-15

APPLICANT AND AGENT DETAILS

Applicant

United States Steel Corporation
600 Grant Street,
Pittsburgh,
Pennsylvania, 15219
UNITED STATES OF AMERICA

Agent

SMART & BIGGAR LLP
SUITE 900, 55 METCALFE STREET, P.O.
BOX 2999, STATION D, OTTAWA, ONTARIO,
K1P5Y6

TRADEMARK DETAILS

USS-CDC

Trademark Type

Standard Characters

Goods

Class 06

Steel pipes and tubes for oil and gas drilling and recovery

Application Number 1,975,452
Language of Application English

Filing Date 2019-07-15

APPLICANT AND AGENT DETAILS

Applicant

United States Steel Corporation
600 Grant Street,
Pittsburgh,
Pennsylvania, 15219
UNITED STATES OF AMERICA

Agent

SMART & BIGGAR LLP
SUITE 900, 55 METCALFE STREET, P.O.
BOX 2999, STATION D, OTTAWA, ONTARIO,
K1P5Y6

TRADEMARK DETAILS

USS-CDC HTQ

Trademark Type

Standard Characters

Goods

Class 06

Steel pipes and tubes for oil and gas drilling and recovery

Application Number 1,975,490
Language of Application English

Filing Date 2019-07-15

APPLICANT AND AGENT DETAILS

Applicant

HASBRO, INC.
1027 Newport Avenue
Pawtucket, RI 02861
UNITED STATES OF AMERICA

Agent

BERESKIN & PARR LLP/S.E.N.C.R.L., S.R.L.
SCOTIA PLAZA, 40 KING STREET WEST,
40th FLOOR, TORONTO, ONTARIO, M5H3Y2

TRADEMARK DETAILS

TINYCORN

Trademark Type

Standard Characters

Goods

Class 28

dolls and doll clothing

Application Number 1,975,527
Language of Application English

Filing Date 2019-07-15

APPLICANT AND AGENT DETAILS

Applicant

LULULEMON ATHLETICA CANADA INC.
1818 Cornwall Avenue
Vancouver
BRITISH COLUMBIA
V6J1C7

Agent

DAVID S. LIPKUS
(KESTENBERG SIEGAL LIPKUS LLP), 65
Granby Street, Toronto, ONTARIO, M5B1H8

TRADEMARK DETAILS

ABC PANT

Trademark Type

Standard Characters

Goods

Class 25

clothing, namely, pants and shorts

Application Number 1,975,589
Language of Application English

Filing Date 2019-06-14

APPLICANT AND AGENT DETAILS

Applicant

Nadia Joshua and Damian Joshua in
partnership
436 Brisdale Dr
Brampton
ONTARIO
L7A4P9

Agent

JULIE MACDONELL
(The Trademark Shop), 2300 Yonge St. #1600,
Toronto, ONTARIO, M4P1E4

TRADEMARK DETAILS

SWEETWISE SNACKS

Trademark Type

Standard Characters

Goods

Class 30

(1) Desserts, namely, cakes, cookies, and brownies.

Application Number 1,975,609
Language of Application English

Filing Date 2019-06-14

APPLICANT AND AGENT DETAILS

Applicant

Jonathan Sibony
59 Place Heath
Hampstead
QUEBEC
H3X3L6

Agent

OLLIP P.C.
Gladwin Business Park, 2212 Gladwin
Crescent, Building B, Unit B4, Ottawa,
ONTARIO, K1B5N1

TRADEMARK DETAILS

CAMISERIA UOMO

Trademark Type

Standard Characters

Foreign Character Translation

As provided by the applicant, "Camiseria" is Spanish for "shirt maker" and "Uomo" is Italian for "man"; however, the combined terms have no particular meaning in either Spanish or Italian.

Goods

Class 25

shoes and swim suits

Application Number 1,975,613
Language of Application English

Filing Date 2019-06-14

APPLICANT AND AGENT DETAILS

Applicant

Jonathan Sibony
59 Place Heath
Hampstead
QUEBEC
H3X3L6

Agent

OLLIP P.C.
Gladwin Business Park, 2212 Gladwin
Crescent, Building B, Unit B4, Ottawa,
ONTARIO, K1B5N1

TRADEMARK DETAILS

CABALLERO UOMO

Trademark Type

Standard Characters

Foreign Character Translation

As provided by the applicant, "Caballero" is Spanish for "gentleman" and "Uomo" is Italian for "man"; however, the combined terms have no particular meaning in either Spanish or Italian.

Goods

Class 25

shoes and swim suits

Application Number 1,975,655
Language of Application English

Filing Date 2019-07-16

APPLICANT AND AGENT DETAILS

Applicant

Bayer Aktiengesellschaft
Kaiser-Wilhelm-Allee
51373 Leverkusen,
GERMANY

Agent

GOWLING WLG (CANADA) LLP
SUITE 2600, 160 ELGIN STREET, OTTAWA,
ONTARIO, K1P1C3

TRADEMARK DETAILS

XTRON

Trademark Type

Standard Characters

Goods

Class 05

Preparations for destroying vermin; fungicides, herbicides

Application Number 1,975,668
Language of Application English

Filing Date 2019-07-16

APPLICANT AND AGENT DETAILS

Applicant

CHAUSSURES ESTRADA INC.
3524 Rue Griffith
Montreal
QUEBEC
H4T1A7

Agent

SPIEGEL SOHMER INC.
1255, Peel Street, Suite 1000, Montreal,
Attention: IP department, QUEBEC, H3B2T9

TRADEMARK DETAILS

OHRNG

Trademark Type

Standard Characters

Goods

Class 25

Footwear, namely shoes, sandals, athletic shoes, running shoes, beach footwear, casual shoes, leisure shoes, outdoor winter footwear, hiking shoes, leather shoes, dress shoes, women's shoes

Application Number 1,975,738
Language of Application English

Filing Date 2019-07-16

APPLICANT AND AGENT DETAILS

Applicant

Kangkang International Ltd
16 Starling Cres
Stratford
PRINCE EDWARD ISLAND
C1B2E6

Agent

WITMART INC.
34 King Street East, Suite 500, Toronto,
ONTARIO, M5C2X8

TRADEMARK DETAILS

CYANOS JAY

Trademark Type

Standard Characters

Goods

Class 25

Coats; Down jackets; Fleece jackets; Jackets; Overcoats; Parkas; Skirts; Skorts; Trousers; Vests; Windbreakers; Down suits; Padded jackets

Application Number 1,975,770
Language of Application English

Filing Date 2019-07-16

APPLICANT AND AGENT DETAILS

Applicant

New Avon Company
One Liberty Plaza
165 Broadway
New York, New York 10006
UNITED STATES OF AMERICA

Agent

MBM INTELLECTUAL PROPERTY LAW LLP
275 SLATER STREET, 14TH FLOOR,
OTTAWA, ONTARIO, K1P5H9

TRADEMARK DETAILS

BIRTHDAY BALM

Trademark Type

Standard Characters

Goods

Class 03

Cosmetics, namely lip balms

Application Number 1,975,791
Language of Application English

Filing Date 2019-07-16

APPLICANT AND AGENT DETAILS

Applicant

L'OREAL
14 rue Royale
75008 PARIS,
FRANCE

Agent

FASKEN MARTINEAU DUMOULIN LLP
Tour de la Bourse, Suite 3500, P.O. box 242,
800, Place Victoria, Montréal, QUEBEC,
H4Z1E9

TRADEMARK DETAILS

ROUGE UNLIMITED GLEAM

Trademark Type

Standard Characters

Goods

Class 03

Makeup preparations.

Application Number 1,975,850
Language of Application English

Filing Date 2019-07-17

APPLICANT AND AGENT DETAILS

Applicant

Midwest Capital LLC
619 Victor Drive
Santa Rosa, CA 95401
UNITED STATES OF AMERICA

Agent

MILTONS IP/P.I.
15 Fitzgerald Rd, Suite 200, Ottawa,
ONTARIO, K2H9G1

TRADEMARK DETAILS

FizzyGrigio

Trademark Type

Standard Characters

Foreign Character Translation

The translation of the mark is "sparkling gray" as provided by the applicant.

Goods

Class 33

natural sparkling wines; red wines; sparkling wines; white wines; wine; wines and sparkling wines

Application Number 1,975,901
Language of Application English

Filing Date 2019-07-17

APPLICANT AND AGENT DETAILS

Applicant

Edgewell Personal Care Brands, LLC
6 Research Drive
Shelton, CT 06484
UNITED STATES OF AMERICA

Agent

SMART & BIGGAR LLP
1100-150 York street, TORONTO, ONTARIO,
M5H3S5

TRADEMARK DETAILS

Trademark Type

Design

Visual Representation

Carefree
BREATHE



Goods

Class 05

panty liners and sanitary pads

Application Number 1,976,236
Language of Application English

Filing Date 2019-07-18

APPLICANT AND AGENT DETAILS

Applicant

Bayer Aktiengesellschaft
Kaiser-Wilhelm-Allee
51373 Leverkusen,
GERMANY

Agent

GOWLING WLG (CANADA) LLP
SUITE 2600, 160 ELGIN STREET, OTTAWA,
ONTARIO, K1P1C3

TRADEMARK DETAILS

CAMBALIO

Trademark Type

Standard Characters

Goods

Class 05

Preparations for destroying vermin; fungicides, herbicides

Application Number 1,976,237
Language of Application English

Filing Date 2019-07-18

APPLICANT AND AGENT DETAILS

Applicant

Bayer Aktiengesellschaft
Kaiser-Wilhelm-Allee
51373 Leverkusen,
GERMANY

Agent

GOWLING WLG (CANADA) LLP
SUITE 2600, 160 ELGIN STREET, OTTAWA,
ONTARIO, K1P1C3

TRADEMARK DETAILS

XIVANA

Trademark Type

Standard Characters

Goods

Class 05

Preparations for destroying vermin; fungicides, herbicides

Application Number 1,976,292
Language of Application English

Filing Date 2019-07-18

APPLICANT AND AGENT DETAILS

Applicant

IGT
9295 Prototype Drive
Reno, NV 89521
UNITED STATES OF AMERICA

Agent

COLLEEN CAISSIE-DUPUIS
(c/o IGT Canada Solutions ULC), 328 Urquhart
Avenue, Moncton, NEW BRUNSWICK,
E1H2R6

TRADEMARK DETAILS

LIGHTNING LEGEND

Trademark Type

Standard Characters

Goods

Class 28

(1) Gaming machines, namely, devices which accept a wager; Reconfigurable casino and lottery gaming equipment, namely, gaming machines

(2) Lottery tickets; lottery cards; scratch cards for playing lottery games

Claims

Priority Filing Date: June 27, 2019, Country or Office: UNITED STATES OF AMERICA, Application No: 88491581 in association with the same kind of goods (1)

Application Number 1,976,294
Language of Application English

Filing Date 2019-07-18

APPLICANT AND AGENT DETAILS

Applicant

IGT
9295 Prototype Drive
Reno, NV 89521
UNITED STATES OF AMERICA

Agent

COLLEEN CAISSIE-DUPUIS
(c/o IGT Canada Solutions ULC), 328 Urquhart
Avenue, Moncton, NEW BRUNSWICK,
E1H2R6

TRADEMARK DETAILS

PALACE OF WONDERS

Trademark Type

Standard Characters

Goods

Class 28

(1) Gaming machines, namely, devices which accept a wager; Reconfigurable casino and lottery gaming equipment, namely, gaming machines

(2) Lottery tickets; lottery cards; scratch cards for playing lottery games

Claims

Priority Filing Date: June 27, 2019, Country or Office: UNITED STATES OF AMERICA, Application No: 88491586 in association with the same kind of goods (1)

Application Number 1,976,375
Language of Application English

Filing Date 2019-07-18

APPLICANT AND AGENT DETAILS

Applicant

Boathouse Beverage LLC
168 Imperial Avenue
Westport, CT 06880
UNITED STATES OF AMERICA

Agent

BERESKIN & PARR LLP/S.E.N.C.R.L., S.R.L.
SCOTIA PLAZA, 40 KING STREET WEST,
40th FLOOR, TORONTO, ONTARIO, M5H3Y2

TRADEMARK DETAILS

Trademark Type

Design

Visual Representation



Goods

Class 32

(1) flavoured beers

Class 33

(2) malt-based alcoholic beverages, namely alcoholic malt-based coolers and cocktails, hard seltzer and flavoured hard seltzer

Application Number 1,976,525
Language of Application English

Filing Date 2019-07-19

APPLICANT AND AGENT DETAILS

Applicant

1198054 B.C. Ltd.
2237 Sun Valley Way
Okanagan Falls
BRITISH COLUMBIA
V0H1R2

Agent

LAWSON LUNDELL LLP
1600 CATHEDRAL PLACE, 925 WEST
GEORGIA STREET, VANCOUVER, BRITISH
COLUMBIA, V6C3L2

TRADEMARK DETAILS

Trademark Type

Design

Visual Representation



Goods

Class 21

(1) Wine openers, wine buckets, wine cradles, wine glasses, wine pourers, wine aerators, portable wine cooler bags

Class 25

(2) Clothing, namely, casual clothing, athletic clothing, baseball caps, jackets

Class 33

(3) Wine

Services

Class 35

Administering a wine club by means of selecting wines based on consumer expectations and arranging periodic shipment to club members

Application Number 1,976,535
Language of Application English

Filing Date 2019-07-19

APPLICANT AND AGENT DETAILS

Applicant

Miniclasix, LLC
79N. Franklin Turnpike
Suite 202
Ramsey, NJ 07446
UNITED STATES OF AMERICA

Agent

DEETH WILLIAMS WALL LLP
150 YORK STREET, SUITE 400, TORONTO,
ONTARIO, M5H3S5

TRADEMARK DETAILS

MAX + MOLLY

Trademark Type

Standard Characters

Goods

Class 25

infant and children's clothing, infant bibs not of paper, and infant and children's headgear, namely caps and hats

Application Number 1,976,536
Language of Application English

Filing Date 2019-07-19

APPLICANT AND AGENT DETAILS

Applicant

Miniclasix, LLC
79N. Franklin Turnpike
Suite 202
Ramsey, NJ 07446
UNITED STATES OF AMERICA

Agent

DEETH WILLIAMS WALL LLP
150 YORK STREET, SUITE 400, TORONTO,
ONTARIO, M5H3S5

TRADEMARK DETAILS

CLASIX BEGINNINGS

Trademark Type

Standard Characters

Goods

Class 25

infant and children's clothing, infant bibs not of paper, and infant and children's headgear, namely caps and hats

Application Number 1,976,539
Language of Application English

Filing Date 2019-07-19

APPLICANT AND AGENT DETAILS

Applicant

Miniclasix, LLC
79N. Franklin Turnpike
Suite 202
Ramsey, NJ 07446
UNITED STATES OF AMERICA

Agent

DEETH WILLIAMS WALL LLP
150 YORK STREET, SUITE 400, TORONTO,
ONTARIO, M5H3S5

TRADEMARK DETAILS

MINICLASIX

Trademark Type

Standard Characters

Goods

Class 25

infant and children's clothing, infant bibs not of paper, and infant and children's headgear, namely caps and hats

Application Number 1,976,680
Language of Application English

Filing Date 2019-07-22

APPLICANT AND AGENT DETAILS

Applicant

Shenzhen Xiaowei Technology Co.,Ltd.
401, No.1, Lane No.7, Linggenxia, Shangmugu
Community Pinghu Street, Longgang Distric
518000
Shenzhen, 518000
CHINA

Agent

MARK W. TIMMIS
(MARK TIMMIS LAW CORPORATION), 2595
CAVENDISH AVENUE, VICTORIA, BRITISH
COLUMBIA, V8R2G5

TRADEMARK DETAILS

Mingnos

Trademark Type

Standard Characters

Goods

Class 25

Adhesive bras;Swimming caps;Swim wear;Dresses;Beach cover-ups;Swimwear;Bikinis;Bathing suits;Swimsuits;Sweaters;Sleepwear;Rash guards;Coats;Men's and women's jackets, coats, trousers, vests;Hats;Caps;

Application Number 1,976,718
Language of Application English

Filing Date 2019-07-22

APPLICANT AND AGENT DETAILS

Applicant

GEBERIT HOLDING AG
SCHACHENSTRASSE 77
JONA, 8645
SWITZERLAND

Agent

HUGH D. CAMPBELL
(FINLAYSON & SINGLEHURST), 225 Metcalfe
Street, Suite 700, Ottawa, ONTARIO, K2P1P9

TRADEMARK DETAILS

ALPINA

Trademark Type

Standard Characters

Goods

Class 11

faucets and electronic faucets

Claims

Priority Filing Date: March 19, 2019, Country or Office: UNITED STATES OF AMERICA,
Application No: 88/346,722 in association with the same kind of goods

Application Number 1,976,939
Language of Application English

Filing Date 2019-07-23

APPLICANT AND AGENT DETAILS

Applicant

PayBright Inc.
161 Bay Street, Suite 4530
Toronto
ONTARIO
M5J2S1

Agent

SMART & BIGGAR LLP
SUITE 900, 55 METCALFE STREET, P.O.
BOX 2999, STATION D, OTTAWA, ONTARIO,
K1P5Y6

TRADEMARK DETAILS

PAY IN 4

Trademark Type

Standard Characters

Services

Class 36

collection of debts; consumer credit financing; credit card transaction processing services; electronic foreign exchange payment processing; electronic transfer of money; financing of loans; financing of purchases; money transfer; processing of bank transfer transactions; processing of cash transactions; processing of debit card payments; processing of electronic check payments; processing of savings account transactions; reimbursement payment processing

Application Number 1,976,940
Language of Application English

Filing Date 2019-07-23

APPLICANT AND AGENT DETAILS

Applicant

PayBright Inc.
161 Bay Street, Suite 4530
Toronto
ONTARIO
M5J2S1

Agent

SMART & BIGGAR LLP
SUITE 900, 55 METCALFE STREET, P.O.
BOX 2999, STATION D, OTTAWA, ONTARIO,
K1P5Y6

TRADEMARK DETAILS

PAY IT IN 4

Trademark Type

Standard Characters

Services

Class 36

collection of debts; consumer credit financing; credit card transaction processing services; electronic foreign exchange payment processing; electronic transfer of money; financing of loans; financing of purchases; money transfer; processing of bank transfer transactions; processing of cash transactions; processing of debit card payments; processing of electronic check payments; processing of savings account transactions; reimbursement payment processing

Application Number 1,977,018
Language of Application English

Filing Date 2019-07-23

APPLICANT AND AGENT DETAILS

Applicant

Mastronardi Produce Ltd.
c/o Dinsmore & Shohl LLP
900 Wilshire Drive, Suite 300
Troy, Michigan 48084
UNITED STATES OF AMERICA

Agent

RIDOUT & MAYBEE LLP
5500 North Service Road, Suite 101,
Burlington, ONTARIO, L7L6W6

TRADEMARK DETAILS

BACKYARD BERRIES

Trademark Type

Standard Characters

Goods

Class 31

Fresh fruits and vegetables

Application Number 1,977,020
Language of Application English

Filing Date 2019-07-23

APPLICANT AND AGENT DETAILS

Applicant

TURTLE WAX, INC.
2250 W Pinehurst Blvd., Suite 150
Addison, IL 60101
UNITED STATES OF AMERICA

Agent

BAKER & MCKENZIE LLP
BROOKFIELD PLACE, 181 BAY STREET,
SUITE 2100, P.O. BOX 874, TORONTO,
ONTARIO, M5J2T3

TRADEMARK DETAILS

TURTLE WAX HYDRO-REPEL

Trademark Type

Standard Characters

Goods

Class 12

Windshield wiper blades for vehicles.

Application Number 1,977,021
Language of Application English

Filing Date 2019-07-23

APPLICANT AND AGENT DETAILS

Applicant

Mastronardi Produce Ltd.
c/o Dinsmore & Shohl LLP
900 Wilshire Drive, Suite 300
Troy, Michigan 48084
UNITED STATES OF AMERICA

Agent

RIDOUT & MAYBEE LLP
5500 North Service Road, Suite 101,
Burlington, ONTARIO, L7L6W6

TRADEMARK DETAILS

BERRY LOCAL

Trademark Type

Standard Characters

Goods

Class 31

Fresh fruits and vegetables

Application Number 1,977,190
Language of Application English

Filing Date 2019-07-24

APPLICANT DETAILS

Applicant

Etty van Dijken
744719 Oxford Road 17
Woodstock
ONTARIO
N4S7V7

TRADEMARK DETAILS

The Wicked Bee

Trademark Type

Standard Characters

Goods

Class 04

beeswax candles

Application Number 1,977,508
Language of Application English

Filing Date 2019-07-25

APPLICANT AND AGENT DETAILS

Applicant

CHOI BOK YI
4, Donggwang-ro 24-gil, Seocho-gu
Seoul,
REPUBLIC OF KOREA

Agent

BENOÎT & CÔTÉ INC.
560 boul. Crémazie Est, 3e étage, Montréal,
QUEBEC, H2P1E8

TRADEMARK DETAILS

Trademark Type

Design

Visual Representation



BONJUK

Foreign Character Transliteration

As provided by the applicant, the Korean characters are the equivalent to the coined word BONJUK.

Goods

Class 30

cooked rice; rice

Application Number 1,977,514
Language of Application English

Filing Date 2019-07-25

APPLICANT AND AGENT DETAILS

Applicant

Conair LLC
1 Cummings Point Road
Stamford, CT 06902
UNITED STATES OF AMERICA

Agent

CHITIZ PATHAK LLP
77 King Street West, TD North Tower, Suite
700, P.O. Box 118, Toronto, ONTARIO,
M5K1G8

TRADEMARK DETAILS

THE POWER BEHIND YOUR BEAUTY

Trademark Type

Standard Characters

Goods

Class 08

(1) electric irons for styling hair

Class 11

(2) hand-held electric hair dryers

Application Number 1,977,517
Language of Application English

Filing Date 2019-07-25

APPLICANT AND AGENT DETAILS

Applicant

2494293 Ontario Corp.
doing business as Pocket Money Capital
Unit 4, 7500 Highway 27
Woodbridge
ONTARIO
L4H0J2

Agent

ROBERT H. NAKANO
(GARDINER ROBERTS LLP), Bay Adelaide
Center - East Tower, 22 Adelaide St West,
Suite 3600, Toronto, ONTARIO, M5H4E3

TRADEMARK DETAILS

Trademark Type

Design

Visual Representation



Services

Class 35

(1) Administration of business payroll for others; Administration of customer loyalty programs

Class 36

(2) Debit card services; Issuance of debit cards; Pre-paid gift card services; Payday loan processing services

Application Number 1,977,521
Language of Application English

Filing Date 2019-07-25

APPLICANT AND AGENT DETAILS

Applicant

2494293 Ontario Corp.
doing business as Pocket Money Capital
Unit 4, 7500 Highway 27
Woodbridge
ONTARIO
L4H0J2

Agent

ROBERT H. NAKANO
(GARDINER ROBERTS LLP), Bay Adelaide
Center - East Tower, 22 Adelaide St West,
Suite 3600, Toronto, ONTARIO, M5H4E3

TRADEMARK DETAILS

POCKET MONEY CAPITAL

Trademark Type

Standard Characters

Services

Class 35

(1) Administration of business payroll for others; Administration of customer loyalty programs

Class 36

(2) Debit card services; Issuance of debit cards; Pre-paid gift card services; Payday loan processing services

Application Number 1,977,603
Language of Application English

Filing Date 2019-07-25

APPLICANT AND AGENT DETAILS

Applicant

REDPATH SUGAR LTD./SUCRE REDPATH
LTÉE
95 Queen's Quay East
Toronto
ONTARIO
M5E1A3

Agent

GOWLING WLG (CANADA) LLP
SUITE 2600, 160 ELGIN STREET, OTTAWA,
ONTARIO, K1P1C3

TRADEMARK DETAILS

REDPATH COLLECTION

Trademark Type

Standard Characters

Goods

Class 30

sugar, natural sweeteners

Application Number 1,977,670
Language of Application French

Filing Date 2019-07-26

APPLICANT AND AGENT DETAILS

Applicant

L'OREAL
14 rue Royale
75008 PARIS,
FRANCE

Agent

FASKEN MARTINEAU DUMOULIN LLP
Tour de la Bourse, Suite 3500, P.O. box 242,
800, Place Victoria, Montréal, QUÉBEC,
H4Z1E9

TRADEMARK DETAILS

INFALLIBLE MORE THAN CORRECTOR

Trademark Type

Standard Characters

Goods

Class 03

Makeup.

Application Number 1,977,697
Language of Application English

Filing Date 2019-07-26

APPLICANT AND AGENT DETAILS

Applicant

THE TRUSTEES FOR THE TIME BEING OF
THE FNM TRUST, A South African Trust
Hilltop Park
33 Surprise Road
Westmead
Pinetown, 3610
SOUTH AFRICA

Agent

BERESKIN & PARR LLP/S.E.N.C.R.L., S.R.L.
SCOTIA PLAZA, 40 KING STREET WEST,
40th FLOOR, TORONTO, ONTARIO, M5H3Y2

TRADEMARK DETAILS

GLOBAL CITIZEN

Trademark Type

Standard Characters

Goods

Class 18

luggage, carrying bags

Claims

Priority Filing Date: July 16, 2019, Country or Office: SOUTH AFRICA, Application No: 2019/19758
in association with the same kind of goods

Application Number 1,977,707
Language of Application English

Filing Date 2019-07-26

APPLICANT AND AGENT DETAILS

Applicant

Q Tonic, LLC (doing business as Q Drink)
45 Main Street, Suite 850
Brooklyn, NY 11201
UNITED STATES OF AMERICA

Agent

SMART & BIGGAR LLP
1100-150 York street, TORONTO, ONTARIO,
M5H3S5

TRADEMARK DETAILS

Q GINGER ALE

Trademark Type

Standard Characters

Goods

Class 32

Drink mixers namely, non-alcoholic carbonated beverages; soft drinks

Application Number 1,977,735
Language of Application English

Filing Date 2019-07-26

APPLICANT DETAILS

Applicant

Wayne Owen
10 Foxfire Chase
Uxbridge
ONTARIO
L9P1R4

TRADEMARK DETAILS

Soften Your Footprint

Trademark Type

Standard Characters

Goods

Class 25

Footwear namely, shoes, boots, sandals, and slippers.

Application Number 1,977,746
Language of Application English

Filing Date 2019-07-26

APPLICANT AND AGENT DETAILS

Applicant

Systagenix Wound Management, Limited
3M Centre Cain Road
Bracknell
Berkshire, RG12 8HT
UNITED KINGDOM

Agent

OSLER, HOSKIN & HARCOURT LLP
SUITE 1900, 340 ALBERT STREET,
OTTAWA, ONTARIO, K1R7Y6

TRADEMARK DETAILS

ADAPTIC TOUCH

Trademark Type

Standard Characters

Goods

Class 05

Surgical and wound dressings.

Application Number 1,977,771
Language of Application English

Filing Date 2019-07-26

APPLICANT AND AGENT DETAILS

Applicant

A&H Sportswear Co., Inc.
110 Commerce Way
Stockertown, PA 18083
UNITED STATES OF AMERICA

Agent

GOWLING WLG (CANADA) LLP
SUITE 2600, 160 ELGIN STREET, OTTAWA,
ONTARIO, K1P1C3

TRADEMARK DETAILS

PENBROOKE

Trademark Type

Standard Characters

Goods

Class 25

Swimwear; Cover-ups.

Application Number 1,977,773
Language of Application English

Filing Date 2019-07-26

APPLICANT AND AGENT DETAILS

Applicant

A&H Sportswear Co., Inc.
110 Commerce Way
Stockertown, PA 18083
UNITED STATES OF AMERICA

Agent

GOWLING WLG (CANADA) LLP
SUITE 2600, 160 ELGIN STREET, OTTAWA,
ONTARIO, K1P1C3

TRADEMARK DETAILS

LOOK AND FEEL SLIMMER!

Trademark Type

Standard Characters

Goods

Class 25

Swimwear; Cover-ups.

Application Number 1,977,853
Language of Application English

Filing Date 2019-07-27

APPLICANT DETAILS

Applicant

Badry Ventures Ltd. dba The Olive Junction
3-45575 Keith Wilson Rd
Chilliwack
BRITISH COLUMBIA
V2R0M6

TRADEMARK DETAILS

Trademark Type

Design

Visual Representation



THE OLIVE JUNCTION

Colour Claim

Colour is claimed as a feature of the trademark. The trademark consists of a circular outer border in olive green (hex code #808437), within which are the words "THE OLIVE JUNCTION" in white. Inside the olive green circle, there is a white circle. Within the white circle, there is a "J" in dark charcoal grey (hex code #292A24) to the right, and an olive green (hex code #808437) star to the left. Underneath the olive green circle are the words "THE OLIVE JUNCTION." The words "THE" and "JUNCTION" are in dark charcoal grey (hex code #292A24) and the word "OLIVE" is in olive green (hex code #808437).

Goods

Class 29

(1) olive oils

Class 30

(2) balsamic vinegar; pasta sauce; salt; salt and pepper; sauce mixes; sauces for barbecued meat

Application Number 1,977,863
Language of Application English

Filing Date 2019-07-29

APPLICANT DETAILS

Applicant

XIANGXING (FUJIAN) BAG & LUGGAGE
GROUP CO., LTD.
NO.336, LONGJIANG ROAD, FUQING CITY
FUJIAN PROVINCE, 350300,
CHINA

TRADEMARK DETAILS

Trademark Type

Design

Visual Representation

SUISSEWIN

Goods

Class 18

Carry-all bags; Travelling trunks; Luggage trunks; Backpacks; School bags; Pocket wallets;
Luggage tags; Unworked leather; Travelling bags; Umbrellas.

Application Number 1,977,909
Language of Application French

Filing Date 2019-07-29

APPLICANT AND AGENT DETAILS

Applicant

L'OREAL
14 rue Royale
75008 PARIS
FRANCE

Agent

FASKEN MARTINEAU DUMOULIN LLP
Tour de la Bourse, Suite 3500, P.O. box 242,
800, Place Victoria, Montréal, QUÉBEC,
H4Z1E9

TRADEMARK DETAILS

VOLCANO DROP

Trademark Type

Standard Characters

Goods

Class 03

Produits de soins de la peau.

Claims

Priority Filing Date: June 06, 2019, Country or Office: FRANCE, Application No: 4557624 in association with the same kind of goods

Application Number 1,977,948
Language of Application English

Filing Date 2019-07-29

APPLICANT AND AGENT DETAILS

Applicant

X Gear 101 LLC
Suite 102-212
5614 W. Grand Parkway South
Richmond, TX 77406
UNITED STATES OF AMERICA

Agent

DEETH WILLIAMS WALL LLP
150 YORK STREET, SUITE 400, TORONTO,
ONTARIO, M5H3S5

TRADEMARK DETAILS

Trademark Type

Design

Visual Representation



Goods

Class 25

Clothing, namely, shirts and hats

Application Number 1,977,964
Language of Application English

Filing Date 2019-07-29

APPLICANT AND AGENT DETAILS

Applicant

Ranpak Corp.
7990 Auburn Road
Concord Township, OH 44077
UNITED STATES OF AMERICA

Agent

MOFFAT & CO.
P.O. Box 2088, Station D, Ottawa, ONTARIO,
K1P5W3

TRADEMARK DETAILS

PADPAK GUARDIAN

Trademark Type

Standard Characters

Goods

Class 07

(1) machines for shaping packing paper

Class 16

(2) packing paper

Claims

Priority Filing Date: February 01, 2019, Country or Office: UNITED STATES OF AMERICA, Application No: 88/286,076 in association with the same kind of goods (2); February 01, 2019, Country or Office: UNITED STATES OF AMERICA, Application No: 88/286,076 in association with the same kind of goods (1)

Application Number 1,977,966
Language of Application English

Filing Date 2019-07-29

APPLICANT AND AGENT DETAILS

Applicant

LES PLACEMENTS ARDEN INC. / ARDEN
HOLDINGS INC.
2575 Pitfield Blvd.
Montreal
QUEBEC
H4S1W8

Agent

MARK SUMBULIAN
4141 Sherbrooke Street West, #650,
Westmount, QUEBEC, H3Z1B8

TRADEMARK DETAILS

CLOUD82

Trademark Type

Standard Characters

Goods

Class 25

Shoes, sneakers and insoles for footwear

Application Number 1,977,968
Language of Application English

Filing Date 2019-07-29

APPLICANT AND AGENT DETAILS

Applicant

LES PLACEMENTS ARDEN INC. / ARDEN
HOLDINGS INC.
2575 Pitfield Blvd.
Montreal
QUEBEC
H4S1W8

Agent

MARK SUMBULIAN
4141 Sherbrooke Street West, #650,
Westmount, QUEBEC, H3Z1B8

TRADEMARK DETAILS

FLY FOAM

Trademark Type

Standard Characters

Goods

Class 25

Shoes, sneakers and insoles for footwear

Application Number 1,978,065
Language of Application English

Filing Date 2019-07-30

APPLICANT DETAILS

Applicant

Dirk CS Maree
608-5332 Sayward Hill Crescent
Victoria
BRITISH COLUMBIA
V8Y3H8

TRADEMARK DETAILS

SHIFTPULSE TECHNICAL SERVICES

Trademark Type

Standard Characters

Services

Class 37

Advisory and consulting services relating to the mining of metals, mine contracting; mining for precious metals.

Application Number 1,978,252
Language of Application English

Filing Date 2019-07-30

APPLICANT AND AGENT DETAILS

Applicant

THE SEVEN EIGHTY INC.
206 Caldwell Way NW
Edmonton
ALBERTA
T6M2X2

Agent

MCKAY-CAREY & COMPANY
6928 ROPER ROAD, SUITE 200,
EDMONTON, ALBERTA, T6B3H9

TRADEMARK DETAILS

PRAIRIE OYSTERS

Trademark Type

Standard Characters

Goods

Class 25

Casual clothing, athletic clothing, formal wear, sleepwear, swimwear, jackets, outdoor winter clothing, socks, and underwear; Baby clothing; Hats; Scarves, mittens, and gloves; Neckties; Belts; Shoes, boots, sandals, and slippers

Application Number 1,978,679
Language of Application English

Filing Date 2019-08-01

APPLICANT AND AGENT DETAILS

Applicant

NUNA INTERNATIONAL B.V.
Van der Valk Boumanweg 178-c, 2352 JD
Leiderdorp
NETHERLANDS

Agent

GOWLING WLG (CANADA) LLP
1 MAIN STREET WEST, HAMILTON,
ONTARIO, L8P4Z5

TRADEMARK DETAILS

COVE

Trademark Type

Standard Characters

Goods

Class 20

(1) Cribs; cradles; playards; playpens; bassinets; baby rocking beds; high chairs; baby walkers; bouncing seats; baby bouncers; baby rocking chairs; children's feeding seats; carry cots; travel bags for playpens; tables; beds; high chair accessories, namely, seat pads; cushions; pillows; cushioned chairs; wooden bedstead; bed for children; mats for playpens; baby beds and their parts and fittings; mattresses; portable and foldable beds for babies; portable beds for babies; furniture namely, baby changing platforms and baby changing tables.

Class 27

(2) High chair accessories, namely, spill pads namely, plastic floor mats for catching spills.

Class 28

(3) High chair accessories, namely, toy bars that attach to high chairs.

Application Number 1,978,836
Language of Application English

Filing Date 2019-08-02

APPLICANT AND AGENT DETAILS

Applicant

SHANDONG WEIMA PUMPS
MANUFACTURING CO., LTD.
THE CROSS OF YUNTAI MOUNTAIN AND
PANLONGHE STREET
HIGH-TECH DISTRICT
LAIWU CITY, SHANDONG PROVINCE,
CHINA

Agent

WITMART INC.
34 King Street East, Suite 500, Toronto,
ONTARIO, M5C2X8

TRADEMARK DETAILS

Trademark Type

Design

Visual Representation



Foreign Character Translation

As provided by the applicant, the translation of the Chinese characters is "strength, horse"

Foreign Character Transliteration

As provided by the applicant, the transliteration of Chinese characters is "WEI, MA"

Goods

Class 07

Oil filters; oil-well pumping machines; drilling rig; oil separators; extracting machines for chemical processing; dredging machines; centrifugal pumps; electrical drills; screw pumps; hydraulic pumps

Application Number 1,978,998
Language of Application English

Filing Date 2019-08-03

APPLICANT DETAILS

Applicant

Hanq's International Inc.
85 Westhampton Dr
Thornhill
ONTARIO
L4J7J7

TRADEMARK DETAILS

creatus art

Trademark Type

Standard Characters

Disclaimer

The right to the exclusive use of the word ART is disclaimed apart from the trademark.

Goods

Class 02

(1) ceramic paints; gum resins; inks for printers and photocopiers; inorganic pigments; mordant dyes; organic pigments; paint and lacquer glazes; paint thinners; paints for arts and crafts; printing inks, coatings, pigments and dispersions for use in the graphic arts industry; turpentine

Class 16

(2) adhesive tapes for stationery purposes; books; canvas for painting; crayons; drawing boards; drawing pads; drawing pens; drawing protractors; drawing rulers; file pockets for stationery use; framed artwork; glitter for stationery purposes; ink; lithographic works of art; painters' brushes; painting sets; paintings; palettes for painters; paper; paper stationery; paste for stationery purposes; pencils; pencils for painting and drawing; pens; periodical publications; staplers; stationery cases; stationery personal organizers; stationery stickers; writing stationery

Application Number 1,979,317
Language of Application English

Filing Date 2019-08-07

APPLICANT AND AGENT DETAILS

Applicant

Revive Therapeutics LLC
8250 SW 27th Avenue
Ocala, FL 34476
UNITED STATES OF AMERICA

Agent

GOWLING WLG (CANADA) LLP
SUITE 1600, 1 FIRST CANADIAN PLACE, 100
KING STREET WEST, TORONTO, ONTARIO,
M5X1G5

TRADEMARK DETAILS

BRST

Trademark Type

Standard Characters

Goods

Class 05

drug delivery agents in the form of dissolvable tablets that provide rapid release of the active ingredients for a wide variety of pharmaceuticals

Claims

Priority Filing Date: February 08, 2019, Country or Office: UNITED STATES OF AMERICA,
Application No: 88294940 in association with the same kind of goods

Application Number 1,979,371
Language of Application English

Filing Date 2019-08-07

APPLICANT AND AGENT DETAILS

Applicant

Desert Harvest, Inc.
PO Box 1412
Hillsborough, NC 27278
UNITED STATES OF AMERICA

Agent

SMART & BIGGAR LLP
SUITE 900, 55 METCALFE STREET, P.O.
BOX 2999, STATION D, OTTAWA, ONTARIO,
K1P5Y6

TRADEMARK DETAILS

ALOE RENEW

Trademark Type

Standard Characters

Goods

Class 03

Non-medicated skin care preparations, non-medicated feminine hygiene wash, body wash, hand cream, body cream, hair care preparations

Claims

Priority Filing Date: August 07, 2019, Country or Office: UNITED STATES OF AMERICA,
Application No: 88/569549 in association with the same kind of goods

Application Number 1,979,760
Language of Application English

Filing Date 2019-08-08

APPLICANT AND AGENT DETAILS

Applicant

VINS ARTERRA CANADA, DIVISION
QUÉBEC, INC.
175, chemin Marieville
Rougemont
QUEBEC
J0L1M0

Agent

BARRETTE LEGAL INC.
445 Viger Ouest, Suite 200, Montreal,
QUEBEC, H2Z2B8

TRADEMARK DETAILS

Trademark Type

Design

Visual Representation



Foreign Character Translation

As provided by the applicant, PEREIRA is translated in English as "pear". Furthermore, VINHO REGIONAL LISBOA are translated in English as "regional Lisbon wine".

Goods

Class 33

Wines

Application Number 1,979,818
Language of Application English

Filing Date 2019-08-09

APPLICANT AND AGENT DETAILS

Applicant

S.C. Johnson & Son, Inc.
1525 Howe Street
Racine, WI 53403-2236
UNITED STATES OF AMERICA

Agent

BERESKIN & PARR LLP/S.E.N.C.R.L., S.R.L.
SCOTIA PLAZA, 40 KING STREET WEST,
40th FLOOR, TORONTO, ONTARIO, M5H3Y2

TRADEMARK DETAILS

NIGHT WOODS

Trademark Type

Standard Characters

Goods

Class 03

(1) air fragrancing preparations; wax melts being fragrancing preparations

Class 04

(2) candles

Class 05

(3) air deodorants; air deodorizing preparations; air purifying preparations; carpet deodorizers; deodorants for textiles; odour neutralizing preparations for carpets; room deodorants

Application Number 1,980,164
Language of Application English

Filing Date 2019-08-12

APPLICANT AND AGENT DETAILS

Applicant

Sanford, L.P.
6655 Peachtree Dunwoody Road
Atlanta, GA 30328
UNITED STATES OF AMERICA

Agent

GOWLING WLG (CANADA) LLP
SUITE 1600, 1 FIRST CANADIAN PLACE, 100
KING STREET WEST, TORONTO, ONTARIO,
M5X1G5

TRADEMARK DETAILS

RUB-A-DUB

Trademark Type

Standard Characters

Goods

Class 16

felt tip markers; fiber-tip markers

Application Number 1,980,475
Language of Application French

Filing Date 2019-08-14

APPLICANT AND AGENT DETAILS

Applicant

AGRILAIT S.E.C.
83 Rang De l'Église
Saint-Guillaume
QUÉBEC
J0C1L0

Agent

LAVERY DE BILLY S.E.N.C.R.L.
925, Grande Allée Ouest, Bureau 500,
Québec, QUÉBEC, G1S1C1

TRADEMARK DETAILS

ST-GUILLAUME

Trademark Type

Standard Characters

Territorial Restriction

Registration will apply solely to the territorial area in which it was established that the trademark has acquired distinctiveness, namely the province of Quebec.

Goods

Class 29

Cheeses.

Application Number 1,980,488
Language of Application English

Filing Date 2019-08-14

APPLICANT AND AGENT DETAILS

Applicant

KELLOGG COMPANY
ONE KELLOGG SQUARE
BATTLE CREEK, MI 49016
UNITED STATES OF AMERICA

Agent

CYNTHIA D. MASON
(Mason Professional Corporation), 1000
Innovation Drive, Suite 500, Kanata,
ONTARIO, K2K3E7

TRADEMARK DETAILS

INCOGMEATO

Trademark Type

Standard Characters

Goods

Class 29

Veggie food products, namely, vegetable based meat and fish substitutes, egg substitutes, cheese substitutes and soy-based food beverages used as a milk substitute; textured vegetable protein; frozen packaged entrees consisting of vegetable based patties or links; jerky; sausages; vegetarian sausages; jerky made with meat substitutes and vegetables; cheese; cheese substitutes; meat substitutes; vegetable based meat substitutes; meat substitute based charcuterie; pre-packaged meals consisting of vegan cheese and meat substitutes; pre-packaged meals consisting of nuts and cheese

Claims

Priority Filing Date: July 16, 2019, Country or Office: UNITED KINGDOM, Application No: UK00003414285 in association with the same kind of goods

Application Number 1,980,767
Language of Application English

Filing Date 2019-08-15

APPLICANT AND AGENT DETAILS

Applicant

IGT
9295 Prototype Drive
Reno, NV 89521
UNITED STATES OF AMERICA

Agent

COLLEEN CAISSIE-DUPUIS
(c/o IGT Canada Solutions ULC), 328 Urquhart
Avenue, Moncton, NEW BRUNSWICK,
E1H2R6

TRADEMARK DETAILS

FU GUI HAO MEN

Trademark Type

Standard Characters

Foreign Character Translation

As provided by the applicant, the translation of the foreign words is: The door of wealth and riches

Goods

Class 28

- (1) Gaming machines, namely, devices which accept a wager; Reconfigurable casino and lottery gaming equipment, namely, gaming machines
- (2) Lottery tickets; lottery cards; scratch cards for playing lottery games

Claims

Priority Filing Date: August 09, 2019, Country or Office: UNITED STATES OF AMERICA,
Application No: 88572703 in association with the same kind of goods (1)

Application Number 1,980,769
Language of Application English

Filing Date 2019-08-15

APPLICANT AND AGENT DETAILS

Applicant

IGT
9295 Prototype Drive
Reno, NV 89521
UNITED STATES OF AMERICA

Agent

COLLEEN CAISSIE-DUPUIS
(c/o IGT Canada Solutions ULC), 328 Urquhart
Avenue, Moncton, NEW BRUNSWICK,
E1H2R6

TRADEMARK DETAILS

Trademark Type

Design

Visual Representation



Goods

Class 28

(1) Gaming machines, namely, devices which accept a wager; Reconfigurable casino and lottery gaming equipment, namely, gaming machines

(2) Lottery tickets; lottery cards; scratch cards for playing lottery games

Claims

Priority Filing Date: August 09, 2019, Country or Office: UNITED STATES OF AMERICA,
Application No: 88572699 in association with the same kind of goods (1)

Application Number 1,980,807
Language of Application English

Filing Date 2019-08-15

APPLICANT AND AGENT DETAILS

Applicant

2008474 ONTARIO INC.
45 Esander Drive
Toronto
ONTARIO
M4G4C5

Agent

GOWLING WLG (CANADA) LLP
SUITE 1600, 1 FIRST CANADIAN PLACE, 100
KING STREET WEST, TORONTO, ONTARIO,
M5X1G5

TRADEMARK DETAILS

Trademark Type

Design

Visual Representation



Colour Claim

Colour is claimed as a feature of the trademark. The letters AMSTER in the word AMSTERDAM are red and the remainder of the letters, words and design features in the mark are black.

Services

Class 43

bar and restaurant services

Application Number 1,980,934
Language of Application English

Filing Date 2019-08-16

APPLICANT DETAILS

Applicant

Dian Ifeoma Amaechi
148 Plumrose Pathway
Toronto
ONTARIO
M1B4B4

TRADEMARK DETAILS

Trademark Type

Design

Visual Representation



Colour Claim

Colour is claimed as a feature of the trademark. The word "IBUCHI" is black. The top triangle, from left to right is light orange fading into dark orange. The next triangle to the right is dark orange at the bottom, fading to light orange in the middle and yellow at the top. The next triangle to the right is yellow at the bottom, fading to light orange in the middle and dark orange at the top. The next triangle is orange at the bottom, fading into a light yellow at the top. The next triangle is yellow at the bottom fading into a light orange, and then a dark orange at the top. The last triangle is dark orange at the bottom fading into a yellow at the top. The half circle that is centered at the base of the triangles is burnt orange fading into a dark orange from right to left.

Foreign Character Translation

As provided by the applicant, IBUCHI word origin: Igbo meaning: having God ie. faith

Goods

Class 25

athletic apparel; athletic clothing; athletic shorts; athletic tights; athletic wear; baseball caps; bathing suits; beach cover-ups; crop tops; denim coats; denim jackets; denim jeans; denim pants; denim shirts; dress clothing; dress pants; dress shirts; dress shoes; dress skirts; dress suits; dresses; dresses made from skins; dressing gowns; dressing gowns and bath robes; driving

gloves; duffel coats; duffle coats; dungarees; dust coats; duster coats; ear muffs; earmuffs; embossed soles and heels of rubber or of plastic materials; espadrilles; esparto shoes or sandals; evening coats; evening dresses; evening footwear; evening gowns; exercise footwear; exercise wear; fashion hats; gym shorts; gym suits; gym wear; hats; jackets and socks; jogging pants; jogging shoes; jogging suits; jump suits; jumper dresses; jumpers; jumpsuits; kimonos; knitted hats; knitted sweaters; knitted tops; latex suits; leather jackets; leather pants; leather trousers; leg warmers; lingerie; long jackets; long sleeve pullovers; long sleeve shirts; long sleeved vests; outdoor winter clothing; overalls; overcoats; pants; pullovers; rain jackets; shirts; short pants; short petticoats; short trousers; short-sleeve shirts; short-sleeved shirts; short-sleeved t-shirts; shorts; sport coats; sport jackets; sport shirts; sport stockings; sports bras; sports caps and hats; sports clothing; sports coats; sports footwear; sports jackets; sportswear; sweat bands; sweat jackets; sweat pants; sweat shirts; sweat socks; sweat suits; sweat tops; swimwear; t-shirts; tank tops; tights; track pants; track suits; training suits; trench coats; trouser socks; winter coats; winter jackets; women's blouses; women's shirts; women's shoes; women's socks; women's sportswear; women's suits; yoga pants

Services

Class 35

advertising services for promoting a series of films for others; advertising services for promoting public awareness of environmental issues and initiatives; advertising services for promoting public awareness of the benefits of physical activity; advertising services for promoting the brokerage of stocks and other securities for others; advertising services of a radio and television advertising agency; advertising text publication services for others; advertising the goods and services of others; advertising the goods and services of others in periodicals, brochures and newspapers; advertising the goods and services of others in the popular and professional press; advertising the goods and services of others through all public communication means; advertising the goods and services of others via electronic media and specifically the internet; advice and information about customer services and product management and prices on Internet sites in connection with purchases made over the Internet; advice and information concerning commercial business management; advice in the field of business management and marketing; advice in the running of establishments as franchises; advice relating to the organisation and management of business; advisory and consultancy services in the field of export, export services, export promotion information and services; advisory services for business management; advisory services relating to business management; advisory services relating to business management and business operations; audience rating determination for radio and television broadcasts; auditing of financial statements; auditing utility rates for others; bartering of goods for others; beverage concession stands; billing services; book-keeping; business acquisition and merger consultation; business administration and management; business administration consultancy; business administration consulting services; business administration services; business appraisals; business appraisals and evaluations in business matters; business auditing; business consulting in the field of business acquisitions and mergers; business invoicing services; business management; business management advice; business management analysis; business management and advice; business management and enterprise organization consultancy; business management and organization consultancy; copying of documents; copying of documents for others; corporate identity services; creating and updating advertising material for others; creation of trade-marks for others; credit card registration services; credit card reward program services; customer service in the field of airline reservations; customer service in the field of automobile repair; customer service in the field of computer servicing; database management; database marketing services in the form of compiling customer specific databases; design of marketing surveys; design of public opinion

surveys; developing and coordinating volunteer projects for charitable organisations; developing and coordinating volunteer projects for charitable organizations; developing marketing strategies and marketing concepts for others; developing promotional campaigns for business for others; developing promotional campaigns for others; development of hospital management systems; development of marketing strategies and concepts for others; direct mail advertising of the goods and services of others; direct marketing of the goods and services of others; discount photographic equipment stores; discount sporting goods stores; dissemination of advertising for others via an on-line communications network on the internet; dissemination of advertising for others via the Internet; dissemination of advertising matter for others; distribution of advertisements and commercial announcements for others; distribution of advertising mail and of advertising supplements attached to regular editions for others; distribution of advertising materials for others; economic forecasting and analysis; electronic billboard advertising of the goods and services of others; employee relocation services; employment agencies; employment agency services; employment agency services relating to au pairs; employment counselling and recruiting; employment management agencies; employment outplacement services; employment recruiting services; employment skills testing; evaluation of employee performances; executive recruiting services; executive search and placement services; export and import agencies; fashion show exhibitions for commercial purposes; financial statement preparation and analysis for businesses; flea markets; florist shop services; food concession stands; foreign trade information and consultation; foreign trade information and consultation services; forestry management consulting services; fruit stands; general information clearing house services; gift registry services; goods import-export agencies; handbill distribution; health care cost containment services; home demonstrations selling jewellery; home demonstrations selling lingerie; home demonstrations selling toys; home jewellery parties; home lingerie parties; hospital administration; human resources consultancy; human resources consultation; human resources consulting services; human resources management; human resources outsourcing services; import and export agencies; import-export agencies; import-export agencies in the field of energy; import-export agency services; income tax consulting services; indexing of documents for others; interim business management; inventory control; inventory control services; inventory management in the field of auto parts; inventorying merchandise; invoicing; invoicing services; issuing and updating of advertising texts for others; jewellery concession stands; job and personnel placement; job placement; job placement services; key return registration services; keypunching; labour exchanges; labour unions; layout services for advertising purposes; leasing of office equipment; literary agencies; magazine advertising for others; magazine mail order services; mail order book clubs; mail order services in the field of books; mail order services in the field of clothing; mail order services in the field of furniture; mail order services in the field of jewellery; mail order services in the field of shoes; mail order services in the field of toys; mail sorting, handling and receiving; mailing list preparation; management and compilation of computerised databases; management and compilation of computerized databases; management and operation assistance to commercial businesses; management of an airline company; management of computerized databases; management of health care clinics for others; management of performing artists; management of professional athletes; market analysis; market analysis and research; market analysis and research services; market analysis and studies; market assessment services; market opinion polling studies; market reports and studies; market research by means of a computer database; market research services; market research studies; market segmentation consultation; market studies; market study and analysis of market studies; marketing analysis services; marketing research; marketing services in the field of arranging for the distribution of the products of others; marketing services in the field of evaluating markets for existing goods and services of others; media relations services; mediation and conclusion of commercial transactions for others;

mediation of advertising for others; mediation of agreements for others for the sale and purchase of goods; mediation of contracts for purchase and sale of products; mediation of trade business for third parties; medical billing; medical cost management; modeling agencies; modeling services for advertising or sales promotion; modelling for advertising or sales promotion; negotiation and conclusion of commercial transactions for third parties; negotiation of business contracts for others; news clipping services; newspaper advertising for others; newspaper subscriptions; offering technical assistance in the establishment and operation of bakery shop franchises; offering technical assistance in the establishment and operation of car wash franchises; offering technical assistance in the establishment and operation of clothing store franchises; offering technical assistance in the establishment and operation of restaurant franchises; office machines and equipment rental; office support staff recruitment services; on-line advertising for others on computer networks; on-line advertising the goods and services of others on computer communications networks; online auction bidding for others; on-line auctioneering; on-line trading services in which seller posts products to be auctioned and bidding is done via the Internet; online advertising for others via a computer communications network; online auction services; online department store services; online retail services for downloadable and pre-recorded music and movies; online retail services for downloadable digital music; online retail services for downloadable ring tones; online sales of arts and crafts; online sales of automobile parts; online sales of car audio electronics; online sales of clothing; online sales of downloadable prerecorded music; online sales of downloadable ring tones; online sales of food items; online sales of footwear; online sales of headwear; online sales of home entertainment electronics; online sales of housewares; online sales of lingerie; online sales of photographic equipment; online sales of sporting goods; online sales of toys; operating marketplaces; operation of a book store; operation of a clothing store; operation of a department store; operation of a furniture store; operation of a telephone switchboard for others; operation of computer equipment store; operation of grocery store; opinion polling; organisation and management of customer loyalty programs; organisation for a third party of telephone welcoming services and of telephone receptionist services; organisation of fashion shows for commercial purposes; organisation of Internet auctions; organization of fashion shows for promotional purposes; organizing and conducting job fairs; outsourcing of insurance services; outsourcing of legal services; outsourcing of payroll services; outsourcing of translation services; outsourcing of web development services; payroll preparation; payroll preparation services; personality testing for business purposes; personality testing for recruitment purposes; personnel consultancy; personnel management; personnel management and employment consultancy; personnel management assistance services; personnel management consultancy; personnel management consultation; personnel management consulting; personnel placement; personnel placement and recruitment; personnel recruitment; personnel recruitment and placement; personnel recruitment services and employment agencies; personnel relocation; personnel relocation services; personnel selection using psychological testing; phonetic transcription; photocopying; photocopying services; placement of staff; placing advertisements for others; planning concerning business management, namely, searching for partners for amalgamations and business take-overs as well as for business establishments; political action committee services in the form of promoting the interests of auto workers; political action committee services in the form of promoting the interests of farmers; preparation of business reports; preparation of custom advertisements for others; preparation of financial statements; preparation of wage slips; preparing advertisements for others; preparing and placing advertisements for others; preparing and placing of advertisements for others; preparing and placing outdoor advertisements for others; preparing business reports; preparing income tax reports; preparing mailing lists; press advertising consultancy; press clipping services; price comparison rating of accommodations; price comparison services; printing of advertising matter for

others; processing warranty registration documents for others; procurement of contracts for the purchase and sale of goods; procurement of contracts for the purchase and sale of goods and services; procurement services in the form of purchasing computer hardware; procurement services in the form of purchasing heavy equipment; procurement services in the form of purchasing vehicles; procurement services in the form of purchasing weapons; procuring of contracts for the purchase and sale of goods of others; producing promotional videotapes, video discs, and audio visual recordings for others; product demonstration services in shop windows by live models; product demonstrations of kitchen appliances; production of advertising films for others; production of advertising materials for others; production of advertising matter and commercials for others; production of infomercials; production of television commercials; professional consultancy relating to personnel management; profit survey and analysis services; promoting goods and services through the distribution of discount cards; promoting the artwork of others by means of providing online portfolios via a website; promoting the goods and services of others by arranging for sponsors to affiliate their goods and services with soccer competitions; promoting the goods and services of others through the distribution of discount cards; promoting the sale of credit card accounts through the administration of incentive award programs; promoting the sale of goods and services by awarding purchase points for credit card use; promoting the sale of goods and services of others by awarding purchase points for credit card use; promoting the sale of goods and services through a consumer loyalty program; promoting the sale of goods and services through promotional contests and the distribution of related printed material; promotional management for sports personalities; providing a searchable online advertising guide featuring the goods and services of other on-line vendors on the internet; providing advertising space in a periodical; providing advertising space in periodicals, newspapers and magazines; providing advice in the field of business management and marketing; providing an on-line commercial information directory on the internet; providing an online commercial information directory on the Internet; providing and rental of advertising space on the internet; providing and rental of exhibition stands and booths; providing business information in the field of social media; providing business marketing information for others; providing consumer product information in the field of office computer equipment via a website; providing electronic verification of online orders of digital content; providing employment counseling services; providing focus group services; providing home shopping services of car audio electronics via the Internet; providing home shopping services of fitness equipment via the Internet; providing home shopping services of home entertainment electronics by means of television; providing home shopping services of jewellery by telephone; providing home shopping services of sporting goods via the Internet; providing hotel rate comparison information; providing information in the area of global sustainable business solutions; providing information in the field of time management; providing market intelligence services; providing marketing consulting in the field of social media; providing marketing strategies for others; providing on-line auction services; providing online auction services; providing online commercial directory information services; providing promotional coupon programs pertaining to a line of food products; providing quality management systems auditing; providing tax information via an interactive website; provision of information relating to market studies; provision of market research information; provision of space on websites for advertising goods and services; psychological testing for the selection of personnel; psychometric testing for the selection of personnel; public opinion polling; public opinion surveys; public policy research services; public relations; public relations consultancy; public relations services; public utilities cost management; publication of publicity texts; publicity agencies; publicity agency services; publicity agents; publicity bureau services; purchasing agents; rating of accommodations services; real estate sales management services; recruitment of flight personnel, technical ground staff and non-technical ground staff; relocation services for business; relocation services for businesses; rental of

advertising space; rental of advertising space on web sites; rental of office equipment in co-working facilities; rental of office machinery and equipment; rental of photocopiers; rental of photocopying machines; rental of sales stands; rental of typewriters and copying machines; rental of vending machines; renting of advertising spaces; restaurant management for others; resumé preparation services; retail book store services; retail clothing store services; retail computer equipment store services; retail convenience store services; retail department store services; retail furniture store services; retail grocery store services; retail sale of audio equipment; retail sale of automobile parts; retail sale of clothing; retail sale of food; retail sale of jewellery; retail sale of lingerie; retail sale of photographic equipment; retail sale of sporting goods; retail sale of toys; retail services for alcoholic beverages; retail services for jewellery; retail services for pharmaceutical, veterinary and sanitary preparations and medical supplies; retail services for works of art provided by art galleries; retail services in relation to litter for animals; retail services in relation to works of art; retail shop window display arrangement services; retail store reward programs; retail store services featuring clothing; résumé preparation services; sale of cars; sale of clothing; sale of customized gift baskets; sale of flowers; sale of motor vehicles; sales demonstration for others; sales demonstrations of kitchen appliances; sales demonstrations of surgical instruments; sales promotion for others provided through the distribution and the administration of privileged user cards; sales volume tracking for others; sales volume tracking services; sample distribution; scrap dealerships; scriptwriting for advertising purposes; search engine optimisation; search engine optimization; secretarial and clerical services; secretarial services; selling domain names; services for provision of foreign trade information; services to determine the audience affected by advertisements; serving as a human resources department for others; shop at home parties selling jewellery; shop at home parties selling lingerie; shop at home parties selling toys; shop window display arrangement services; shop window dressing; shopping centre administration services; shorthand; shorthand secretarial services; shorthand services; shorthand typing; shorthand typing services; social media strategy consulting; sports recruiting services for high school athletes; staff placement services; statistical analysis and reporting services for business purposes; statistical evaluation of data from market studies; statistical evaluation of market research data; statistical evaluations of marketing data; stenographic transcription; stenographic transcription services; stenography; stenography services; strategic business planning; street vending of flowers; street vending of food; subscription to a television channel; subscriptions to books; subscriptions to comic books; subscriptions to electronic journals; subscriptions to newspapers; subscriptions to reviews; supermarkets; supply chain management services; talent agencies; talent management agencies; tax advisory services; tax and taxation planning, advice, information and consultancy services; tax auditing; tax auditing services; tax declaration procedure services; tax filing services; tax preparation; tax preparation services; telemarketing services; telephone and television auctions; telephone answering for unavailable subscribers; telephone answering service; telephone answering services; telephone directory assistance services; telephone order-taking services for others; telephone voice message transcription services; television advertising for others; temporary employment agencies; temporary employment agency services; temporary personnel services; testing to determine employment skills; testing to determine professional competency; theatrical agencies; tracking and monitoring energy consumption for others for account auditing purposes; travel reward programs; typing; typing services; updating and maintenance of data in computer databases; vehicle registration and title transfer; vending machine services; voter registration; wage payroll preparation; web indexing for commercial or advertising purposes; web site traffic optimisation; web site traffic optimization; wholesale sales of auto parts; wholesale sales of clothing; wholesale sales of home entertainment electronics; wholesale sales of sporting goods; wholesale services for pharmaceutical, veterinary and sanitary preparations and medical supplies; wholesale store

services featuring clothing; window display arrangement services; window display services; window dressing services for advertising purposes; word processing; word processing and typing services; work analysis to determine worker skill sets and other worker requirements; writing of curriculum vitae for others; writing of publicity texts for others; writing of résumés for others;

Application Number 1,980,995
Language of Application English

Filing Date 2019-08-16

APPLICANT AND AGENT DETAILS

Applicant

HBI BRANDED APPAREL ENTERPRISES,
LLC
1000 East Hanes Mill Road
Winston-Salem, North Carolina 27105
UNITED STATES OF AMERICA

Agent

GOWLING WLG (CANADA) LLP
1 PLACE VILLE MARIE, 37TH FLOOR/37E
ETAGE, MONTREAL, QUEBEC, H3B3P4

TRADEMARK DETAILS

AUTHENTIC ATHLETICWEAR

Trademark Type

Standard Characters

Goods

Class 25

Casual clothing; sportswear; undergarments; hosiery; sleepwear; caps; underwear, brassieres, socks, shorts, pants, sweatshirts, sweatpants, tights, leggings, tank tops, jackets, shirts, t-shirts.

Application Number 1,980,996
Language of Application English

Filing Date 2019-08-16

APPLICANT AND AGENT DETAILS

Applicant

HBI BRANDED APPAREL ENTERPRISES,
LLC
1000 East Hanes Mill Road
Winston-Salem, North Carolina 27105
UNITED STATES OF AMERICA

Agent

GOWLING WLG (CANADA) LLP
1 PLACE VILLE MARIE, 37TH FLOOR/37E
ETAGE, MONTREAL, QUEBEC, H3B3P4

TRADEMARK DETAILS

AUTHENTIC ATHLETIC APPAREL SINCE 1919

Trademark Type

Standard Characters

Goods

Class 25

Casual clothing; sportswear; undergarments; hosiery; athletic clothing; underwear, brassieres, socks, shorts, pants, sweatshirts, sweatpants, tights, leggings, tank tops, jackets, shirts, t-shirts, caps, visors, namely, cap visors, sun visors, visors for athletic use.

Application Number 1,981,004
Language of Application English

Filing Date 2019-08-16

APPLICANT AND AGENT DETAILS

Applicant

ProSlide Technology Inc.
2650 Queensview Drive, Suite 150
Ottawa
ONTARIO
K2B8H6

Agent

SMART & BIGGAR LLP
SUITE 900, 55 METCALFE STREET, P.O.
BOX 2999, STATION D, OTTAWA, ONTARIO,
K1P5Y6

TRADEMARK DETAILS

SWITCHBACK

Trademark Type

Standard Characters

Goods

Class 28

amusement park rides; amusement park water rides; water slides;

Application Number 1,981,438
Language of Application English

Filing Date 2019-08-21

APPLICANT AND AGENT DETAILS

Applicant

Curtis Yuel
128-1 Snow St
Winnipeg
MANITOBA
R3T2M4

Agent

RONALD S. ADE LAW CORPORATION
102 - 1015 Wilkes Avenue, Winnipeg,
MANITOBA, R3P2R8

TRADEMARK DETAILS

Trademark Type

Design

Visual Representation



Goods

Class 25

clothing, namely, shirts, tank tops, t-shirts, sweat shirts, hooded sweatshirts, pants, shorts, socks, underwear, jackets, caps, and hats.

Application Number 1,981,444
Language of Application English

Filing Date 2019-08-21

APPLICANT AND AGENT DETAILS

Applicant

LT OVERSEAS NORTH AMERICA, INC.
11130 Warland Drive
Cypress, CA 90630
UNITED STATES OF AMERICA

Agent

GOWLING WLG (CANADA) LLP
SUITE 2600, 160 ELGIN STREET, OTTAWA,
ONTARIO, K1P1C3

TRADEMARK DETAILS

ROYAL

Trademark Type

Standard Characters

Goods

Class 29

(1) Vegetable-based side dishes; Lentil-based side dishes; dried pulses based side dishes; Processed lentils; dried pulses.

Class 30

(2) Duck sauce, Hollandaise sauce, Peanut sauce, Mint sauce, Picante sauce, Pasta sauce, Jerk sauce, Artichoke sauce, Barbecue sauce, Curry sauce, Soy sauce, Hot sauce, Tomato sauce, Chili sauce, Brown sauce, Fish sauce, Sweet and sour sauce, Hot chili pepper sauce, Grilling sauces, Fruit sauces, Garlic-based sauces, Organic curry sauces, Tomato-based sauces; Spices; Naan bread; Flat bread.

Claims

Priority Filing Date: March 15, 2019, Country or Office: UNITED STATES OF AMERICA, Application No: 88342593 in association with the same kind of goods (2); March 15, 2019, Country or Office: UNITED STATES OF AMERICA, Application No: 88342593 in association with the same kind of goods (1)

Application Number 1,981,866
Language of Application French

Filing Date 2019-08-23

APPLICANT AND AGENT DETAILS

Applicant

JOHN SCOTTI AUTOMOTIVE LTD./JOHN
SCOTT! AUTOMOTIVE LTEE
4305 Metropolitan Boulevard East
St-Leonard
QUÉBEC
H1R1Z4

Agent

THERRIEN COUTURE JOLI-COEUR S.E.N.C.
R.L.
1100, boul. René-Lévesque O., #2000,
Montréal, QUÉBEC, H3B4N4

TRADEMARK DETAILS

DINGY'S VINTAGE PARTS

Trademark Type

Standard Characters

Goods

Class 12

Automobile parts for old (vintage) vehicles, namely structural parts for automobiles.

Application Number 1,981,969
Language of Application English

Filing Date 2019-08-23

APPLICANT AND AGENT DETAILS

Applicant

Soon Coffee Inc.
2720 26 Ave SW
Calgary
ALBERTA
T3E7V8

Agent

COASTAL TRADEMARK SERVICES LIMITED
1081 Cambie Street, Vancouver, BRITISH
COLUMBIA, V6B5L7

TRADEMARK DETAILS

SOON COFFEE

Trademark Type

Standard Characters

Goods

Class 30

coffee; roasted coffee

Services

Class 43

café and restaurant services

Application Number 1,982,025
Language of Application English

Filing Date 2019-08-23

APPLICANT AND AGENT DETAILS

Applicant

Junghak Yang
322 4501 North Rd
Burnaby
BRITISH COLUMBIA
V3N4R7

Agent

COASTAL TRADEMARK SERVICES LIMITED
1081 Cambie Street, Vancouver, BRITISH
COLUMBIA, V6B5L7

TRADEMARK DETAILS

Trademark Type

Design

Visual Representation



Goods

Class 03

(1) skin care preparations; cosmetics

Class 05

(2) medicated skin care preparations for treating, reducing, and preventing lines, pores, and loss of skin firmness; medicated skin care preparations for dry skin and damaged skin caused by dryness, age, age spots, sun exposure, acne, blemishes, and stress, namely, creams, lotions, gels, toners, cleaners and peels

Services

Class 44

plastic and cosmetic surgery clinic services; plastic surgery; cosmetic surgery; consultation services relating to skin care

Application Number 1,982,204
Language of Application English

Filing Date 2019-08-26

APPLICANT AND AGENT DETAILS

Applicant

WESTLAKE DIMEX LLC
28305 State Route 7
Marietta, OH 45750
UNITED STATES OF AMERICA

Agent

MACRAE & CO.
326 Somerset Street West, Ottawa, ONTARIO,
K2P0J9

TRADEMARK DETAILS

CABLE MAN

Trademark Type

Standard Characters

Goods

Class 09

Sheaths for electric cables; Sleeves for electric cables

Claims

Priority Filing Date: March 29, 2019, Country or Office: UNITED STATES OF AMERICA,
Application No: 88/362,982 in association with the same kind of goods

Application Number 1,982,205
Language of Application English

Filing Date 2019-08-26

APPLICANT AND AGENT DETAILS

Applicant

WESTLAKE DIMEX LLC
28305 State Route 7
Marietta, OH 45750
UNITED STATES OF AMERICA

Agent

MACRAE & CO.
326 Somerset Street West, Ottawa, ONTARIO,
K2P0J9

TRADEMARK DETAILS

LINE BOSS

Trademark Type

Standard Characters

Goods

Class 09

Sheaths for electric cables; Sleeves for electric cables

Claims

Priority Filing Date: March 29, 2019, Country or Office: UNITED STATES OF AMERICA,
Application No: 88/362,993 in association with the same kind of goods

Application Number 1,982,270
Language of Application English

Filing Date 2019-08-27

APPLICANT AND AGENT DETAILS

Applicant

Linyi Shengde Plastic Co.,Ltd
Liguan Industrial Park, Liguan Town, Lanshan
District, Linyi
Shandong,
CHINA

Agent

YURI CHUMAK
c/o Dickinson Wright LLP, 199 Bay Street,
Suite 2200, Toronto, ONTARIO, M5L1G4

TRADEMARK DETAILS

Trademark Type

Design

Visual Representation



Goods

Class 22

vehicle covers, not fitted; brattice cloth; Tarpaulins; awnings of textile; awnings of synthetic materials; Tarpaulins; dust sheets; tents.

Application Number 1,982,402
Language of Application English

Filing Date 2019-08-27

APPLICANT AND AGENT DETAILS

Applicant

New Avon Company
One Liberty Plaza
165 Broadway
New York, NY 10006
UNITED STATES OF AMERICA

Agent

MBM INTELLECTUAL PROPERTY LAW LLP
275 SLATER STREET, 14TH FLOOR,
OTTAWA, ONTARIO, K1P5H9

TRADEMARK DETAILS

SPARKLING GRAPEFRUIT & ORANGE BLOSSOM

Trademark Type

Standard Characters

Goods

Class 03

skin care preparations; fragrances; soaps for personal use

Application Number 1,982,468
Language of Application English

Filing Date 2019-08-28

APPLICANT AND AGENT DETAILS

Applicant

Melissa Stone
10-220 Ormond Dr
Oshawa
ONTARIO
L1G6T5

Agent

WITMART INC.
34 King Street East, Suite 500, Toronto,
ONTARIO, M5C2X8

TRADEMARK DETAILS

Trademark Type

Design

Visual Representation



Services

Class 41

Conducting fitness classes namely online classes; developing fitness programs; Personal fitness training services and consultancy

Application Number 1,982,605
Language of Application French

Filing Date 2019-08-28

APPLICANT AND AGENT DETAILS

Applicant

EMPÉRIA INDUSTRIES INC.
502-2800 Boul De La Côte-Vertu
Montreal
QUÉBEC
H4R2M5

Agent

BERNARD COLAS
(Colas Moreira Kazandjian Zikovsky), 2020
Rue University, Suite 1920, Montreal,
QUÉBEC, H3A2A5

TRADEMARK DETAILS

Sommet mondial 4.0 au féminin

Trademark Type

Standard Characters

Territorial Restriction

CANADA

Services

Class 41

Organisation de séminaires, de conférences et de congrès pour la promotion des intérêts de personnes qui travaillent dans l'industrie manufacturière ou qui y sont associées.

Application Number 1,982,867
Language of Application English

Filing Date 2019-08-29

APPLICANT AND AGENT DETAILS

Applicant

49TH PARALLEL ROASTERS INC.
Unit 112-6741 Cariboo Road
Burnaby
BRITISH COLUMBIA
V3N4A3

Agent

GOWLING WLG (CANADA) LLP
SUITE 2600, 160 ELGIN STREET, OTTAWA,
ONTARIO, K1P1C3

TRADEMARK DETAILS

Old School Espresso

Trademark Type

Standard Characters

Goods

Class 30

Coffee, ground coffee, coffee beans

Application Number 1,982,868
Language of Application English

Filing Date 2019-08-29

APPLICANT AND AGENT DETAILS

Applicant

49TH PARALLEL ROASTERS INC.
Unit 112-6741 Cariboo Road
Burnaby
BRITISH COLUMBIA
V3N4A3

Agent

GOWLING WLG (CANADA) LLP
SUITE 2600, 160 ELGIN STREET, OTTAWA,
ONTARIO, K1P1C3

TRADEMARK DETAILS

123°W Longitude Blend

Trademark Type

Standard Characters

Goods

Class 30

Coffee, ground coffee, coffee beans

Application Number 1,982,935
Language of Application English

Filing Date 2019-08-29

APPLICANT AND AGENT DETAILS

Applicant

Cobian Corporation
1739 Melrose Dr
Suite 101
San Marcos, CA 92078
UNITED STATES OF AMERICA

Agent

GOWLING WLG (CANADA) LLP
SUITE 2600, 160 ELGIN STREET, OTTAWA,
ONTARIO, K1P1C3

TRADEMARK DETAILS

Trademark Type

Design

Visual Representation



Goods

Class 25

Footwear, namely, sandals and shoes; men's, women's and children's clothing, namely, t-shirts; headwear, namely, hats;

Application Number 1,983,272
Language of Application English

Filing Date 2019-09-03

APPLICANT AND AGENT DETAILS

Applicant

Trevan Aaron Braveboy
Unit 2 - 2535 Eglinton Avenue West
Toronto
ONTARIO
M6M1T2

Agent

WITMART INC.
34 King Street East, Suite 500, Toronto,
ONTARIO, M5C2X8

TRADEMARK DETAILS

Trademark Type

Design

Visual Representation



Goods

Class 25

Hats; Hooded sweatshirts; Jackets; Sweat pants; Sweaters; T-shirts; long sleeved shirts; socks; track suits

Application Number 1,983,329
Language of Application English

Filing Date 2019-09-03

APPLICANT AND AGENT DETAILS

Applicant

Colgate-Palmolive Canada Inc.
Two Morneau Sobeco Centre
895 Don Mills Road, 6th Floor
Toronto
ONTARIO
M3C1W3

Agent

SMART & BIGGAR LLP
1100-150 York street, TORONTO, ONTARIO,
M5H3S5

TRADEMARK DETAILS

GOOD FOR THE EARTH + BODY

Trademark Type

Standard Characters

Goods

Class 03

Personal care products, namely non-medicated body and skin cleansing preparations

Application Number 1,983,370
Language of Application English

Filing Date 2019-09-03

APPLICANT AND AGENT DETAILS

Applicant

Corteva Agriscience LLC
9330 Zionsville Road
Indianapolis, Indiana 46268
UNITED STATES OF AMERICA

Agent

METHOD LAW PROFESSIONAL
CORPORATION
4211 Yonge Street, Suite 310, Toronto,
ONTARIO, M2P2A9

TRADEMARK DETAILS

ONMIRA

Trademark Type

Standard Characters

Goods

Class 05

Pesticides, preparations for destroying vermin, fungicides, herbicides, insecticides.

Application Number 1,983,460
Language of Application English

Filing Date 2019-09-04

APPLICANT AND AGENT DETAILS

Applicant

Caleres, Inc.
8300 Maryland Avenue
St. Louis, MO 63105
UNITED STATES OF AMERICA

Agent

SMART & BIGGAR LLP
1100-150 York street, TORONTO, ONTARIO,
M5H3S5

TRADEMARK DETAILS

LIFESTRIDE SIGNATURE

Trademark Type

Standard Characters

Goods

Class 25

footwear namely shoes, boots, slippers, sandals, athletic shoes

Claims

Priority Filing Date: September 03, 2019, Country or Office: UNITED STATES OF AMERICA,
Application No: 88/602,364 in association with the same kind of goods

Application Number 1,983,538
Language of Application French

Filing Date 2019-09-04

APPLICANT AND AGENT DETAILS

Applicant

CORPA FLORA INC.
5000 rue d'Iberville
#218
Montréal
QUÉBEC
H2H2S6

Agent

BROUILLETTE LEGAL INC.
1050, Côte du Beaver Hall, Bureau 1500,
MONTREAL, QUÉBEC, H2Z0A5

TRADEMARK DETAILS

CORPA FLORA

Trademark Type

Standard Characters

Goods

Class 03

Lip balms; cosmetics; anti-wrinkle creams; eye contour creams; body creams; face creams; hand creams; eye creams; skin conditioning creams for cosmetic purposes; exfoliating scrubs for the face; micellar water; body exfoliants; makeup removing gels; body gels; cosmetic oils; anti-aging moisturizers; body moisturizers; facial moisturizers; cosmetic towelettes; body lotions; face lotions; hand lotions for cosmetic use; skin masks; body cleansers; facial cleansers; perfumes; body powders; face powders; non-medicated skin care preparations; beauty serums; cosmetic kits; emulsions, gels and lotions for skin care.

Application Number 1,983,682
International Registration Number 1473997
Language of Application English

Filing Date 2019-08-20

APPLICANT AND AGENT DETAILS

Applicant

Life Technologies Corporation
5781 Van Allen Way
Carlsbad CA 92008
UNITED STATES OF AMERICA

Agent

MILLER IP LAW
84 Neilson Drive, Toronto, ONTARIO, M9C1V7

TRADEMARK DETAILS

GENEXUS

Trademark Type

Standard Characters

Goods

Class 09

Laboratory instrument, namely, a sequencer in the field of genetic research.

Application Number 1,983,719
Language of Application English

Filing Date 2019-09-05

APPLICANT AND AGENT DETAILS

Applicant

1451825 Ontario Limited DBA Bowers Pet
Products Corporation
3687 Nashua Drive
Unit 2
Mississauga
ONTARIO
L4V1V5

Agent

RIDOUT & MAYBEE LLP
5500 North Service Road, Suite 101,
Burlington, ONTARIO, L7L6W6

TRADEMARK DETAILS

RINGO

Trademark Type
Standard Characters

Goods

Class 20

Pet products, namely, beds for household pets, pet cushions

Application Number 1,983,902
Language of Application English

Filing Date 2019-09-06

APPLICANT AND AGENT DETAILS

Applicant

V Meads Inc.
4061 Britannia Rd
Burlington
ONTARIO
L7M0R8

Agent

BERESKIN & PARR LLP/S.E.N.C.R.L., S.R.L.
SCOTIA PLAZA, 40 KING STREET WEST,
40th FLOOR, TORONTO, ONTARIO, M5H3Y2

TRADEMARK DETAILS

Trademark Type

Design

Visual Representation



BACKEDBYBEES

Goods

Class 30

(1) honey

Class 33

(2) mead

Services

Class 35

(1) retail sale of vegetables, meats, fruits

Class 44

(2) beekeeping services

Application Number 1,983,933
Language of Application English

Filing Date 2019-09-06

APPLICANT AND AGENT DETAILS

Applicant

The Wine Group LLC
4596 S. Tracy Boulevard
Tracy, CA 95377
UNITED STATES OF AMERICA

Agent

CHITIZ PATHAK LLP
77 King Street West, TD North Tower, Suite
700, P.O. Box 118, Toronto, ONTARIO,
M5K1G8

TRADEMARK DETAILS

7 DEADLY

Trademark Type
Standard Characters

Goods

Class 33

Wine.

Application Number 1,983,952
Language of Application English

Filing Date 2019-09-06

APPLICANT AND AGENT DETAILS

Applicant

The Wine Group LLC
4596 S. Tracy Boulevard
Tracy, CA 95377
UNITED STATES OF AMERICA

Agent

CHITIZ PATHAK LLP
77 King Street West, TD North Tower, Suite
700, P.O. Box 118, Toronto, ONTARIO,
M5K1G8

TRADEMARK DETAILS

7 DEADLY ZINS

Trademark Type

Standard Characters

Goods

Class 33

Wine.

Application Number 1,983,975
Language of Application English

Filing Date 2019-09-06

APPLICANT AND AGENT DETAILS

Applicant

The Coca-Cola Company
One Coca-Cola Plaza
ATLANTA, GA 30313
UNITED STATES OF AMERICA

Agent

GOWLING WLG (CANADA) LLP
1 MAIN STREET WEST, HAMILTON,
ONTARIO, L8P4Z5

TRADEMARK DETAILS

Trademark Type

Design

Visual Representation



Goods

Class 32

Non-alcoholic beverages, namely mineral water; carbonated mineral water; flavored mineral water

Application Number 1,984,068
Language of Application English

Filing Date 2019-09-09

APPLICANT AND AGENT DETAILS

Applicant

TripleOne Inc.
8777 Route Transcanadienne, Suite 111
Saint-Laurent, Quebec
QUEBEC
H4S1Z6

Agent

MOFFAT & CO.
P.O. Box 2088, Station D, Ottawa, ONTARIO,
K1P5W3

TRADEMARK DETAILS

LUCY & LOUIS

Trademark Type

Standard Characters

Services

Class 41

(1) Entertainment services, namely, provision of children's play areas at restaurants, provision of arcade games, amusement arcades and amusement arcade rides; providing video and coin operated games

Class 43

(2) Restaurant services

Class 44

(3) Hair salon services for children

Claims

Priority Filing Date: August 21, 2019, Country or Office: UNITED STATES OF AMERICA, Application No: 88587307 in association with the same kind of services (1); August 21, 2019, Country or Office: UNITED STATES OF AMERICA, Application No: 88587307 in association with the same kind of services (3); August 21, 2019, Country or Office: UNITED STATES OF AMERICA, Application No: 88587307 in association with the same kind of services (2)

Application Number 1,984,091
Language of Application English

Filing Date 2019-09-09

APPLICANT AND AGENT DETAILS

Applicant

Soon Coffee Inc.
2720 26 Ave SW
Calgary
ALBERTA
T3E7V8

Agent

COASTAL TRADEMARK SERVICES LIMITED
1081 Cambie Street, Vancouver, BRITISH
COLUMBIA, V6B5L7

TRADEMARK DETAILS

Trademark Type

Design

Visual Representation



Goods

Class 30

coffee; roasted coffee

Services

Class 43

café and restaurant services

Application Number 1,984,169
Language of Application English

Filing Date 2019-09-09

APPLICANT AND AGENT DETAILS

Applicant

IVXVI Solutions Inc.
104 McBride Ave
Bowmanville
ONTARIO
L1C0J9

Agent

HEIRLUME INC.
2300 Yonge St., #1600, Toronto, ONTARIO,
M4P1E4

TRADEMARK DETAILS

IVXVI

Trademark Type

Standard Characters

Goods

Class 18

(1) all-purpose carrying bags and drawstring bags;

Class 25

(2) casual clothing; casual clothing, namely, t-shirts, long-sleeved t-shirts, casual shirts, collared shirts, long sleeve shirts, sweaters, hooded sweatshirts, pants, scarves, belts, hats and caps; ties; skirts and dresses; suits; blazers; pocket squares;

Application Number 1,984,170
Language of Application English

Filing Date 2019-09-09

APPLICANT AND AGENT DETAILS

Applicant

IVXVI Solutions Inc.
104 McBride Ave
Bowmanville
ONTARIO
L1C0J9

Agent

HEIRLUME INC.
2300 Yonge St., #1600, Toronto, ONTARIO,
M4P1E4

TRADEMARK DETAILS

Trademark Type

Design

Visual Representation



Goods

Class 18

(1) all-purpose carrying bags and drawstring bags;

Class 25

(2) casual clothing; casual clothing, namely, t-shirts, long-sleeved t-shirts, casual shirts, collared shirts, long sleeve shirts, sweaters, hooded sweatshirts, pants, scarves, belts, hats and caps; ties; skirts and dresses; suits; blazers; pocket squares;

Application Number 1,984,185
Language of Application English

Filing Date 2019-09-09

APPLICANT AND AGENT DETAILS

Applicant

Diablo Distributing Ltd.
1945 Kirschner Rd
Kelowna
BRITISH COLUMBIA
V1Y4N7

Agent

TED B. URBANEK
(URBANEK INTELLECTUAL PROPERTY
LAW), 1275 West 6th Avenue, Vancouver,
BRITISH COLUMBIA, V6H1A6

TRADEMARK DETAILS

KONCENTRATE

Trademark Type

Standard Characters

Goods

Class 01

fertility enhancement preparations for plant use; plant nutrients; fertilizers; preparations for fortifying plants; plant growth regulating preparations; soil enhancement powders and preparations; plant strengthening preparations; plant growth regulators; plant hormones

Application Number 1,984,231
Language of Application English

Filing Date 2019-09-10

APPLICANT AND AGENT DETAILS

Applicant

PLAYERIUM LTD.
6F, No. 56, Ln. 258 Ruiguang Rd.
Neihu Dist.
Taipei City 114,
TAIWAN

Agent

RONALD S. ADE LAW CORPORATION
102 - 1015 Wilkes Avenue, Winnipeg,
MANITOBA, R3P2R8

TRADEMARK DETAILS

Trademark Type

Design

Visual Representation

Goods

Class 09

3D spectacles; computer software for creating computer games; computer game software, recorded or downloadable; computer peripheral devices, namely, computer mouse, computer keyboards, computer printers, computer scanners; pre-recorded compact discs containing computer games; humanoid robots with artificial intelligence; smartglasses; wearable activity trackers; video game cartridges.

Application Number 1,984,243
Language of Application English

Filing Date 2019-09-10

APPLICANT AND AGENT DETAILS

Applicant

Rheem Manufacturing Company
1100 Abernathy Road
500 Northpark Center
Suite 1700
Atlanta, GA 30328
UNITED STATES OF AMERICA

Agent

STIKEMAN ELLIOTT LLP
SUITE 1600, 50 O'CONNOR STREET,
OTTAWA, ONTARIO, K1P6L2

TRADEMARK DETAILS

RHEEM

Trademark Type

Standard Characters

Goods

Class 11

Tankless water heaters

Application Number 1,984,311
Language of Application English

Filing Date 2019-09-10

APPLICANT DETAILS

Applicant

Padideh Shimi Canada Ltd.
90 Moyal Court
Concord
ONTARIO
L4K4R8

TRADEMARK DETAILS

ACTIMORE

Trademark Type

Standard Characters

Goods

Class 05

Baby formula; beta carotene supplements; diet pills and capsules; dietary supplements for general health and well-being; dietary supplements for promoting weight loss; flaxseed oil dietary supplements; folic acid; herbal supplements for general health and well-being; herbal supplements for the promotion of healthy liver function; herbal supplements for the treatment of arthritis; herbal supplements for the treatment of cancer; herbal supplements for the treatment of cardiovascular diseases; herbal supplements for the treatment of dental and oral diseases; herbal supplements for the treatment of headaches; herbal supplements for the treatment of infectious diseases, namely, urinary tract infections; herbal supplements for the treatment of inflammatory diseases, namely inflammatory bowel diseases and inflammatory connective tissue diseases; herbal supplements for the treatment of the musculoskeletal system, namely, connective tissue diseases, cartilage injuries; herbal supplements for the treatment of the respiratory system; herbal supplements for use in dermatology, namely, dermatitis, eczema, psoriasis; mineral supplements; minerals; multi-vitamin preparations; multivitamins; vitamin and mineral preparations for medical use; vitamin supplements; vitamin tablets; vitamins and vitamin preparations; vitamins in liquid form, collagen peptides, Collagen in liquid form

Application Number 1,984,358
Language of Application English

Filing Date 2019-09-10

APPLICANT AND AGENT DETAILS

Applicant

Bunker Buster LLC
c/o Incorporating Services, Ltd.
3500 South Dupont Highway
Dover, DE 19901
UNITED STATES OF AMERICA

Agent

GOWLING WLG (CANADA) LLP
SUITE 2600, 160 ELGIN STREET, OTTAWA,
ONTARIO, K1P1C3

TRADEMARK DETAILS

Trademark Type

Design

Visual Representation



Goods

Class 18

Backpacks, all-purpose carrying bags, athletic bags, book bags, tote bags, handbags, messenger bags, duffel bags, luggage, wallets, umbrellas

Application Number 1,984,360
Language of Application English

Filing Date 2019-09-10

APPLICANT AND AGENT DETAILS

Applicant

Bunker Buster LLC
c/o Incorporating Services, Ltd.
3500 South Dupont Highway
Dover, DE 19901
UNITED STATES OF AMERICA

Agent

GOWLING WLG (CANADA) LLP
SUITE 2600, 160 ELGIN STREET, OTTAWA,
ONTARIO, K1P1C3

TRADEMARK DETAILS

Trademark Type

Design

Visual Representation



Goods

Class 09

Computer video game software namely software for playing computer video games; cell phone cases, tablet cases, laptop cases, mousepads, computer peripherals, namely, mouse keyboard, keyboard cover, monitor, printer, scanner, streaming camera, headphones

Application Number 1,984,362
Language of Application English

Filing Date 2019-09-10

APPLICANT AND AGENT DETAILS

Applicant

Bunker Buster LLC
c/o Incorporating Services, Ltd.
3500 South Dupont Highway
Dover, DE 19901
UNITED STATES OF AMERICA

Agent

GOWLING WLG (CANADA) LLP
SUITE 2600, 160 ELGIN STREET, OTTAWA,
ONTARIO, K1P1C3

TRADEMARK DETAILS

Trademark Type

Design

Visual Representation



Goods

Class 25

Clothing, namely, shirts, sweatshirts, jerseys, sweaters, jackets, pants, sweatpants, shorts, socks, baseball caps and beanies

Application Number 1,984,364
Language of Application English

Filing Date 2019-09-10

APPLICANT AND AGENT DETAILS

Applicant

Pure Fishing, Inc.
1900 18th Street
Spirit Lake, IA 51360
UNITED STATES OF AMERICA

Agent

GOWLING WLG (CANADA) LLP
SUITE 1600, 1 FIRST CANADIAN PLACE, 100
KING STREET WEST, TORONTO, ONTARIO,
M5X1G5

TRADEMARK DETAILS

BRUTE CAT

Trademark Type

Standard Characters

Goods

Class 28

Fishing rods; fishing reels; fishing rods and fishing reels provided in combination

Claims

Priority Filing Date: September 10, 2019, Country or Office: UNITED STATES OF AMERICA,
Application No: 88/611,051 in association with the same kind of goods

Application Number 1,984,392
Language of Application English

Filing Date 2019-09-10

APPLICANT AND AGENT DETAILS

Applicant

100 Thieves, Inc.
6050 W Jefferson Blvd.
Los Angeles, CA 90016
UNITED STATES OF AMERICA

Agent

OYEN WIGGS GREEN & MUTALA LLP
480-THE STATION, 601 WEST CORDOVA
STREET, VANCOUVER, BRITISH
COLUMBIA, V6B1G1

TRADEMARK DETAILS

HONOR AMONG THIEVES

Trademark Type

Standard Characters

Goods

Class 25

Lifestyle apparel, namely, hoodies, jackets, shirts, jerseys and hats

Claims

Priority Filing Date: September 06, 2019, Country or Office: UNITED STATES OF AMERICA,
Application No: 88/607,680 in association with the same kind of goods

Application Number 1,984,403
Language of Application English

Filing Date 2019-09-10

APPLICANT DETAILS

Applicant

Hanke Wine Industry (Guangzhou) Co., Ltd.
Room A3043, No.27 Factory Building
Sansha Road, Dongchong Town, Nansha
District
Guangzhou, Guangdong, 511453
CHINA

TRADEMARK DETAILS

Trademark Type

Design

Visual Representation

H a n k o l

Goods

Class 33

Aperitifs; arrack; baijiu [Chinese distilled alcoholic beverage]; wine-based beverages; alcoholic fruit-based beverages; alcoholic cocktails; lemon liqueur; alcoholic fruit drinks; Chinese spirit of sorghum [gaolian-jiou]; rice alcohol.

Application Number 1,984,418
Language of Application English

Filing Date 2019-09-11

APPLICANT AND AGENT DETAILS

Applicant

Thor Tech, Inc.
601 East Beardsley Avenue
Elkhart, IN 46514
UNITED STATES OF AMERICA

Agent

GOWLING WLG (CANADA) LLP
SUITE 2600, 160 ELGIN STREET, OTTAWA,
ONTARIO, K1P1C3

TRADEMARK DETAILS

Trademark Type

Design

Visual Representation



Goods

Class 12

Recreational vehicles, namely, motor homes

Claims

Priority Filing Date: September 10, 2019, Country or Office: UNITED STATES OF AMERICA,
Application No: 88/611,224 in association with the same kind of goods

Application Number 1,984,436
Language of Application English

Filing Date 2019-09-11

APPLICANT AND AGENT DETAILS

Applicant

MILAGROS INTERNATIONAL INC.
15F., NO.167, FUSING N. RD.
SONGSHAN DISTRICT
TAIPEI CITY, 10547
TAIWAN

Agent

JENSEN IP
103 - 2150 Thurston Drive, Ottawa, ONTARIO,
K1G5T9

TRADEMARK DETAILS

Trademark Type

Design

Visual Representation

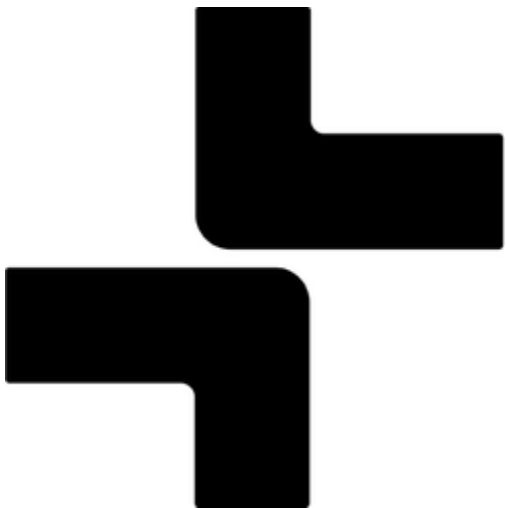

Goods

Class 18

Luggage; all-purpose carrying bags; backpacks; garment bags for travel; handbags; travelling bags; tote bags; backpacks with rolling wheels; briefcases; business cases; duffel bags;

Application Number 1,984,489
Language of Application English

Filing Date 2019-09-11

APPLICANT AND AGENT DETAILS

Applicant

Caleres, Inc.
8300 Maryland Avenue
St. Louis, MO 63105
UNITED STATES OF AMERICA

Agent

SMART & BIGGAR LLP
1100-150 York street, TORONTO, ONTARIO,
M5H3S5

TRADEMARK DETAILS

Trademark Type

Design

Visual Representation

SIGNATURE
LifeStride

Goods

Class 25

footwear namely shoes, boots, slippers, sandals, athletic shoes

Claims

Priority Filing Date: September 10, 2019, Country or Office: UNITED STATES OF AMERICA,
Application No: 88/610,627 in association with the same kind of goods

Application Number 1,984,506
Language of Application English

Filing Date 2019-09-11

APPLICANT AND AGENT DETAILS

Applicant

Bear Archery, Inc.
2200 Stringtown Road
Evansville, IN 47711
UNITED STATES OF AMERICA

Agent

SMART & BIGGAR LLP
SUITE 900, 55 METCALFE STREET, P.O.
BOX 2999, STATION D, OTTAWA, ONTARIO,
K1P5Y6

TRADEMARK DETAILS

F3CB

Trademark Type

Standard Characters

Goods

Class 28

archery bows; archery equipment, namely crossbows

Claims

Priority Filing Date: July 09, 2019, Country or Office: UNITED STATES OF AMERICA, Application No: 88/505,199 in association with the same kind of goods

Application Number 1,984,551
Language of Application English

Filing Date 2019-09-11

APPLICANT AND AGENT DETAILS

Applicant

Abbott Laboratories
100 Abbott Park Road
Abbott Park, IL 60064
UNITED STATES OF AMERICA

Agent

BAKER & MCKENZIE LLP
BROOKFIELD PLACE, 181 BAY STREET,
SUITE 2100, P.O. BOX 874, TORONTO,
ONTARIO, M5J2T3

TRADEMARK DETAILS

SPARKLING RUSH

Trademark Type

Standard Characters

Goods

Class 05

Electrolyte replacement solutions.

Application Number 1,984,756
Language of Application English

Filing Date 2019-09-12

APPLICANT AND AGENT DETAILS

Applicant

BATH & BODY WORKS BRAND
MANAGEMENT, INC.
Seven Limited Parkway
Reynoldsburg, Ohio 43068
UNITED STATES OF AMERICA

Agent

BAKER & MCKENZIE LLP
BROOKFIELD PLACE, 181 BAY STREET,
SUITE 2100, P.O. BOX 874, TORONTO,
ONTARIO, M5J2T3

TRADEMARK DETAILS

VANILLA BEAN NOEL

Trademark Type

Standard Characters

Goods

Class 05

Antibacterial skin soaps hand-sanitizing preparations.

Claims

Priority Filing Date: March 12, 2019, Country or Office: UNITED STATES OF AMERICA,
Application No: 88336576 in association with the same kind of goods

Application Number 1,985,077
Language of Application English

Filing Date 2019-09-13

APPLICANT DETAILS

Applicant
STRYKER CORPORATION
2825 Airview Boulevard
Kalamazoo, MI 49002
UNITED STATES OF AMERICA

TRADEMARK DETAILS

SLINGSHOT

Trademark Type
Standard Characters

Goods

Class 10
surgical instruments and parts and fittings therefor

Application Number 1,985,194
Language of Application English

Filing Date 2019-09-16

APPLICANT AND AGENT DETAILS

Applicant

Home Depot International, Inc.
2455 Paces Ferry Road, NW
Atlanta, GA 30339
UNITED STATES OF AMERICA

Agent

BERESKIN & PARR LLP/S.E.N.C.R.L., S.R.L.
SCOTIA PLAZA, 40 KING STREET WEST,
40th FLOOR, TORONTO, ONTARIO, M5H3Y2

TRADEMARK DETAILS

COMMERCIAL ELECTRIC

Trademark Type

Standard Characters

Goods

Class 11

LED solar fence post caps

Application Number 1,985,445
Language of Application English

Filing Date 2019-09-17

APPLICANT AND AGENT DETAILS

Applicant

IGG Singapore Pte. Ltd., a legal entity
80 Pasir Panjang Road
#18-84
Mapletree Business City, 117372
SINGAPORE

Agent

RICHERS, MCKENZIE & HERBERT LLP
SUITE 1800, 2 BLOOR STREET EAST,
TORONTO, ONTARIO, M4W3J5

TRADEMARK DETAILS

Raids & Puzzles: RPG Quest

Trademark Type

Standard Characters

Goods

Class 09

Computer games downloadable from a global computer network; Computer games for use on mobile and cellular phones; Downloadable computer games; Downloadable electronic games; Downloadable electronic games for use with mobile telephones, handheld computers and tablet computers; Computer video games downloaded via the internet; Computer video games; Computer game cartridges; Recorded computer operating programs; Interactive multimedia computer games; Software for creating virtual reality games; Pre-recorded compact discs containing computer games; Computer software for computer-aided design/computer-aided manufacturing [CAD/CAM]; Computers; Computer hardware; Downloadable electronic publications in the nature of magazines

Services

Class 41

Providing on-line computer games; Online video gaming services; Providing a website featuring on-line computer games and information about computer games; Rental of computer games; Electronic publishing services, namely, publication of text and graphic works of others on-line featuring computer games

Application Number 1,985,447
Language of Application English

Filing Date 2019-09-17

APPLICANT AND AGENT DETAILS

Applicant

IGG Singapore Pte. Ltd., a legal entity
80 Pasir Panjang Road
#18-84
Mapletree Business City, 117372
SINGAPORE

Agent

RICHES, MCKENZIE & HERBERT LLP
SUITE 1800, 2 BLOOR STREET EAST,
TORONTO, ONTARIO, M4W3J5

TRADEMARK DETAILS

Raids & Puzzles

Trademark Type

Standard Characters

Goods

Class 09

Computer games downloadable from a global computer network; Computer games for use on mobile and cellular phones; Downloadable computer games; Downloadable electronic games; Downloadable electronic games for use with mobile telephones, handheld computers and tablet computers; Computer video games downloaded via the internet; Computer video games; Computer game cartridges; Recorded computer operating programs; Interactive multimedia computer games; Software for creating virtual reality games; Pre-recorded compact discs containing computer games; Computer software for computer-aided design/computer-aided manufacturing [CAD/CAM]; Computers; Computer hardware; Downloadable electronic publications in the nature of magazines

Services

Class 41

Providing on-line computer games; Online video gaming services; Providing a website featuring on-line computer games and information about computer games; Rental of computer games; Electronic publishing services, namely, publication of text and graphic works of others on-line featuring computer games

Application Number 1,985,565
Language of Application English

Filing Date 2019-09-18

APPLICANT AND AGENT DETAILS

Applicant

IGT
9295 Prototype Drive
Reno, NV 89521
UNITED STATES OF AMERICA

Agent

COLLEEN CAISSIE-DUPUIS
(c/o IGT Canada Solutions ULC), 328 Urquhart
Avenue, Moncton, NEW BRUNSWICK,
E1H2R6

TRADEMARK DETAILS

REGAL RICHES

Trademark Type

Standard Characters

Goods

Class 28

(1) Gaming machines, namely, devices which accept a wager; Reconfigurable casino and lottery gaming equipment, namely, gaming machines

(2) Lottery tickets; lottery cards; scratch cards for playing lottery games

Claims

Priority Filing Date: August 22, 2019, Country or Office: UNITED STATES OF AMERICA,
Application No: 88588547 in association with the same kind of goods (1)

Application Number 1,985,567
Language of Application English

Filing Date 2019-09-18

APPLICANT AND AGENT DETAILS

Applicant

IGT
9295 Prototype Drive
Reno, NV 89521
UNITED STATES OF AMERICA

Agent

COLLEEN CAISSIE-DUPUIS
(c/o IGT Canada Solutions ULC), 328 Urquhart
Avenue, Moncton, NEW BRUNSWICK,
E1H2R6

TRADEMARK DETAILS

FUSE BLAST

Trademark Type

Standard Characters

Goods

Class 28

Gaming machines, namely, devices which accept a wager; Reconfigurable casino and lottery gaming equipment, namely, gaming machines; lottery tickets; lottery cards; scratch cards for playing lottery games

Application Number 1,985,834
International Registration Number 1223884
Language of Application English

Filing Date 2019-09-02

APPLICANT DETAILS

Applicant

Terence Philip Watts
Westlands Farm,
Padhams Green Road,
Ingatestone
Essex CM4 9NY
UNITED KINGDOM

TRADEMARK DETAILS

Trademark Type

Design

Visual Representation

BWRT

Services

Class 41

(1) Education in the presentation of works for educational purposes in the field of psychology and psychotherapy.

Class 44

(2) Services relating to psychology, that is individual and group psychology services.

Application Number 1,986,310
Language of Application English

Filing Date 2019-09-23

APPLICANT AND AGENT DETAILS

Applicant

Yahoo Inc.
22000 AOL Way
Dulles, VA 20166
UNITED STATES OF AMERICA

Agent

BERESKIN & PARR LLP/S.E.N.C.R.L., S.R.L.
SCOTIA PLAZA, 40 KING STREET WEST,
40th FLOOR, TORONTO, ONTARIO, M5H3Y2

TRADEMARK DETAILS

Trademark Type

Design

Visual Representation



Goods

Class 09

Apparatus for recording, transmission or reproduction of sound or images, namely audio recorders, digital video recorders, audio transmitter units, satellite transmitters, video transmitters, analog-to-digital converters; cash registers, calculators, computer hardware for data processing, computers; computer software to enable users to locate other game players and play games over communications networks; computer software for transmitting electronic mail; computer software for electronic messaging; computer software for electronic transmission of voice messages, text messages and electronic mail, digital images and photographs, video and electronic data files and electronically stored documents via a global computer network; computer software for providing online chat rooms and electronic bulletin boards for transmission of messages among users in the field of general interest; computer software used to search, retrieve, index, and organize voice messages, text messages and electronic mail, digital images and photographs, video and electronic data files, and electronically stored documents; computer software used to enhance the performance and functionality of computer networks; computer software for searching and retrieving content from information directories, websites, and cloud servers, computer servers and network servers on computer networks; computer software for providing an online information

directory, websites, and cloud servers, computer servers and network servers available on computer networks; computer software for providing multiple-user access to a computer network for the dissemination of a wide range and variety of information; computer software that allows users to customize their viewing, listening, and playing experience by selecting and arranging the display of audio, video, and audiovisual elements by users in the fields of music, video and computer games, sports and movies, television shows and music concerts; downloadable computer anti-virus software, computer search engine software; downloadable podcasts in the fields of news, commentary, weather, sports, entertainment, fashion, finance, music, inspiration, health, lifestyle, travel, parenting, science, technology, culture, and wellness; downloadable mobile applications to broadcast live sporting events, broadcasting of sports programming and sports information, including sports scores, sports statistics, player statistics, play-by-play sports commentary and sports editorial commentary; downloadable mobile applications for use in fantasy sports leagues, managing and participating in fantasy sports leagues, providing sports programming and information, providing previews, alerts, replays, video clips of sporting competitions and webcam feeds in the field of sports; downloadable mobile applications for providing entertainment information and news in the fields of celebrities, movie stars, movies and television shows, fashion wear, and sports related news; downloadable mobile applications for sports betting; downloadable films and television programs featuring news, commentary, weather, sports, entertainment, fashion, finance, music, inspiration, health, lifestyle, travel, parenting, science, technology, culture, and wellness provided via a video-on-demand service; downloadable mobile applications for viewing online programs, text, images, multimedia content and videos in the fields of current events, news, commentary, weather, sports, entertainment information and news in the fields of celebrities, movie stars, movies and television shows, fashion wear, personal and corporate finance, music, personal growth and motivation, and self-discovery, general health and well-being, healthy lifestyle, travel, parenting, medical science and social science, technological inventions and innovations, pop culture and urban culture, and mental health and wellness; downloadable application software for electronically exchanging text messages, photographs, graphics, music, podcasts and multimedia content; downloadable mobile application featuring software for use in group communication, namely instant messaging, social media, peer-to-peer sharing of digital text, video, and digital images, and searching and posting of digital text, video and digital images and multimedia content; downloadable mobile applications for accessing information in the fields of news, editorials and opinions concerning current events, weather forecasts, sports, entertainment information and news in the fields of celebrities, movie stars, movies and television shows, fashion wear, personal and corporate finance, music, personal growth and motivation, and self-discovery, general health and well-being, lifestyle, travel, parenting, medical science and social science, technological inventions and innovations, pop culture and urban culture, and mental health and wellness; downloadable mobile applications for electronic chat rooms and bulletin boards; downloadable mobile applications for electronic mail, electronic messaging, and electronic transmission of voice messages, text messages and electronic mail, digital images and photographs, electronically stored documents and videos featuring education and entertainment content; credit cards; downloadable mobile applications featuring software used to link credit cards and user bank accounts; downloadable software in the nature of an application for mobile devices enabling the user to obtain information in the fields of finance and advertising; electronic book; music downloaded from the internet being downloadable music files, voice data downloaded from the internet in the nature of audio recordings featuring voice recordings and podcasts; downloadable music files; films downloaded from the internet in the nature of comedy, action, drama, romance, documentary, animation, biography, crime, fantasy, history, horror, mystery, science fiction, sports, war and western films provided via a video-on-demand service, images downloaded from the internet in the nature of downloadable image files

featuring pictures of musical performances, stills from musical videos, stills from film clips, stills from celebrity interviews, stills from talk shows and stills from television show previews; downloadable image files containing artworks, texts, graphics and photographs; movies downloaded from the internet; digital books downloaded from the internet; downloadable electronic publications in the nature of books, journals, catalogues, directories, magazines and newsletters; electronic sheet music, downloadable; pictures downloaded from the internet; downloadable graphics for mobile phones; game programs downloaded from the internet being downloadable computer game programs, video recording media featuring computer games in the nature of recorded computer games; sound recording carriers being recording and playing devices for sound; downloadable films and television programs featuring news, commentary, weather, sports, entertainment, fashion, finance, music, inspiration, health, lifestyle, travel, parenting, science, technology, culture, and wellness provided via a video-on-demand service; downloadable mobile application software for viewing online programs, text messages and e-mails, digital images and photographs, multimedia content and videos featuring education and entertainment content

Services

Class 35

(1) Advertising the goods and services of others; business management; business administration; advertising and promotional services for others, namely, placing advertisements and promotional displays for others in electronic sites accessed via computer networks; dissemination of advertising matter, namely, providing advertising and graphic, multimedia and interactive images for others through computer networks for use on personal home pages; promoting the goods and services of others by means of operating an online shopping mall with links to the retail web sites of others; providing information via the internet regarding the goods and services of others in the nature of a buyers' guide; provision of online price comparison services; compilation of online business directories; providing an online commercial and residential information directory on the internet; providing online commercial directory information services featuring hyperlinks to other websites; business consulting and technical business assistance regarding the operating, managing, advertising, and marketing of websites for others; business management consulting services; business marketing consultation in the field of online commerce websites; general business networking referral services, namely, promoting the goods and services of others by passing business leads and referrals; providing information regarding coupons provided by others; providing consumer product information in the fields of home computers, fashion wear, furniture, jewellery, home entertainment electronics, pet products, toys, sporting equipment, hand-operated tools for constructions, fitness equipment, computer technology, computer hardware and software, home decorating, and cosmetics via the internet and featuring the goods and services of other online vendors on the internet; electronic calendaring and reminder services for business purposes rendered via computer networks for organizing and recording appointments and events in the nature of a website with features to organize appointments, reminders, and dates; administration of loyalty programs involving discounts or incentives; administration of sales promotion incentive programs; administration of customer incentive programs offered by means of downloadable mobile applications; producing promotional videos and audio-visual recordings for others; providing market research information on goods; word processing; systemization of information into computer databases; auctioneering; rental of advertising space; rental of online advertising banners; provision of an online marketplace for buyers and sellers of goods and services; providing a searchable online advertising guide featuring the goods and services of online vendors, advertising the goods and services of online vendors via a computer communications network and on the Internet, providing online marketplaces for sellers of goods and services, presentation of goods on electronic media and across social media platforms, for retail purposes,

arranging commercial transactions, for others, via online shops; online retail services connected with the sale of downloadable digital music; online retail services connected with the sale of downloadable digital music; arranging subscriptions to telematics, telephone or computer services for others; intermediary services for purchase and sale of goods; business administration of consumer loyalty programs; business administration of consumer loyalty service programs for commercial, promotional and advertising purposes; providing incentive awards programs for customers; data processing in the fields of advertising and direct marketing of the goods and services of others; telephone directory information

Class 36

(2) Insurance; financial affairs and monetary affairs, namely providing information, ratings, reviews and recommendations relating to financial instruments via a web site, stock market information, financial forecasting, financial management and financial analysis services; providing information in the field of money exchange services via a global computer network; providing information in the field of real estate, namely information about real estate appraisals, real estate investments, providing real estate listings and real estate information via the Internet; personal financial planning and investment advisory services; providing information and advice in the field of personal finance, personal financial investments, and the financial aspects of retirement; electronic processing of credit card transactions via a global computer network; online bill and fee payment services; clearing services for payment transactions; conducting cashless payment transactions, namely, processing electronic payments made through prepaid cards, bank transfer transactions, credit card payments, online bill and fee payments, and payments made using a mobile device at a point of sale; credit card and debit card services; electronic commerce payment services; electronic credit card transactions; electronic funds transfer services; electronic processing of payments via a global computer network, namely, processing electronic payments made through prepaid cards, bank transfer transactions, credit cards payments, online bill and fee payments, and payments made using a mobile device at a point of sale; financial consultancy relating to the execution of cashless payment transactions, namely processing electronic payments made through prepaid cards, bank transfer transactions, credit card payments, online bill and fee payments, and payments made using a mobile device at a point of sale; financial information services relating to the automated payment of accounts; information services relating to the automated transfer of funds; mobile payment service; processing of payments at pods and vendor kiosks; loan services; loan financing; financial loan services; instalment loan services; provision of loans; financial investment services; financial services relating to insurance; financial trust planning; financial trust administration; financial trust operations; foreign currency exchange; provision of finance for credit sales; internet banking; electronic banking; international banking; banking services; providing banking information; issuing credit cards; credit card services; issuance of credit cards; guarantees; loan guarantees; management of investments; investment management of funds; financial management of collective investment schemes; management of investments for mutual clubs and societies; monetary transactions, namely electronic cash transactions; payment administration services, namely bill payment services; bill payment processing services and cryptocurrency payment processing services; subscription payment services provided by online call centers; bill payment services provided via wireless telecommunications apparatus and devices; payment transaction card services; processing credit card transactions for others; processing debit card transactions for others; processing electronic payments made through prepaid cards; processing of electronic credit card transactions; processing of electronic payments, namely processing electronic payments made through prepaid cards, bank transfer transactions, credit card payments, online bill and fee payments, and payments made using a mobile device at a point of sale; processing of payment transactions via

the internet, namely processing electronic payments made through prepaid cards, bank transfer transactions, credit card payments, online bill and fee payments, and payments made using a mobile device at a point of sale; processing payments for the purchase of goods and services via an electronic communications network; processing payments made by charge cards; provision of information relating to credit card transactions; transmission of bills and payments; electronic funds transfers; processing of electronic funds transfer, ach, credit card, debit card, electronic check and electronic payments, all being in the nature of credit card and debit card payment processing; clearing and reconciling financial transactions; financial transaction services, namely secure commercial transactions and payment options using a mobile device at a point of sale; cheque verification services; credit card verification services; providing, processing, verifying and authenticating mobile payments, namely, electronic payment services involving electronic processing and subsequent transmission of bill payment data; processing and administering mobile payments, namely, electronic payment services involving electronic processing and subsequent transmission of bill payment data; electronic transfer of virtual currency; information, advisory and consultancy services relating to the aforesaid

Class 38

(3) Telecommunications services, namely broadcasting of audio, video, and multimedia content in the nature of audio and video, by means of radio, cellular communication, wireless communication, the internet, computers, mobile devices, electronic communications networks, and computer networks; electronic mail services; providing multiple user access to computer networks; providing multiple-user access to computer networks for the transfer and dissemination of a wide range of information; electronic transmission of voice messages, text messages and electronic mail, digital images and photographs, videos and electronically stored documents via computer networks, mobile devices, and the internet; internet telephony services; providing telephone communication services via computer terminals and networks; providing access to data or documents stored electronically, all in the nature of providing user access to global computer networks; instant messaging services and multimedia messaging services [MMS]; providing online chat rooms and electronic bulletin/message boards for transmission of messages among users in the field of general interest and for playing games; voicemail services; voice messaging services; transmission of hyperlinks via providing multiple user access to a global computer network; telecommunication services, namely instant messaging, and electronic transmission of text messages, audio and video featuring music, movies, news and sports, and multimedia content among users; news agencies; television broadcasting; radio broadcasting; transmission of telephone communications; transmission of cell phone communications; voice mail services in the nature of box services; telecommunication transmission of value-added network for electronic data transmission; Internet access provider services; transmission of electronic mail; rental of electronic mailbox; providing access to an electronic bulletin board and providing on-line electronic bulletin boards for transmission of messages among computer users; telecommunication line connection, namely, providing telecommunications connections to the internet; providing access to a global computer network; providing user access to global computer networks; telecommunications routing and junction services via a global computer network; chat room information transmission, namely, providing internet chat rooms; provision of telecommunication access to online shopping portals; providing internet chatrooms; providing access to databases; providing streaming of audio and video such as music, movies, television shows, music videos, news and sports webcasts via a website, and streaming of audio and video via the Internet featuring music, movies, news and sports; transmission of telegram communications; providing Internet access via fibre optic broadband networks; satellite telephone transmission, satellite television transmission, and satellite transmission of messages and data for navigation; teleconferencing services; video

conference services; satellite locating signal transmission service, namely services to locate telecommunications transmissions via satellite; communication information service, namely, providing information about telecommunication; transmission of greeting cards online; electronic transmission of digital photo, video and audio files and multimedia content via a peer-to-peer network, wireless broadband and wireless electronic transmission; providing online forums; online television broadcasting; online radio broadcasting; video-on-demand transmission; information transmission services via digital networks, namely providing online directory information services featuring hyperlinks to other websites; streaming of video via the Internet featuring music, movies, television shows, music videos, news and sports; providing online music streaming services

Class 41

(4) Organizing community sporting and athletic competitions and activities, and organizing community festivals; entertainment services in the nature of providing non-downloadable online games and contests for entertainment purposes provided via computer networks; providing information relating to electronic and computer games; facilitating talent bookings for events, namely event booking agency services; lottery services; providing non-downloadable multimedia entertainment content, namely, games and ongoing shows featuring music and sports via computer networks; ongoing entertainment programs broadcast via radio, television, cellular communication, wireless communication, the internet, electronic communications networks, and computer networks in the fields of current events, news, editorials and opinions concerning current events, weather, sports, entertainment information and news in the fields of celebrities, movie stars, movies and television shows, fashion shows and fashion wear, personal and corporate finance, music, personal growth and motivation and self-discovery, general health and well-being, healthy lifestyle, travel, parenting, medical science and social science, technological inventions and innovations, pop culture and urban culture, and wellness; production of music video programs for broadcast on computer networks; production of video programs for broadcast on computer networks; entertainment services, namely, providing information, statistics and commentary in the fields of early childhood education, and primary level, high school level, college level and university level education courses and institutions, entertainment information and news in the fields of celebrities, movie stars, movies and television shows, fashion shows and fashion wear, personal and corporate finance, current event news, sports betting, and sports for children and adults via computer networks; providing theatre listings, show listings, musical concert listings, sporting event listings, television listings, and movie listings via the internet; organizing and conducting fantasy sports contests and leagues; providing online fantasy sports news information; providing sports information via telephone, cellular telephone, wireless communication devices, and the internet; providing information in the field of sports, sports scores, sports statistics, player statistics, play-by-play sports commentary, and sports editorial commentary via the internet; provision of musical performances, musical videos, videos featuring movies, news and sports, film clips, celebrity interviews, talk shows, television show previews, photographs, and multimedia content, provided via a website; online photography services; providing non-downloadable prerecorded music, information in the field of music, and commentary and articles about music, all via computer networks; providing information regarding photography; providing entertainment via podcasts; entertainment services, namely, providing videos in the fields of news, editorials and opinions concerning current events, sports, entertainment in the fields of celebrities, movie stars, movies and television shows, fashion wear, personal and corporate finance, music, personal growth and motivation, and self-discovery, general health and well-being, healthy lifestyle, travel, weather, fashion shows, food nutrition and cooking, parenting, medical and social science, technological inventions and innovations, pop culture and urban culture, and wellness; entertainment services in the nature of a video series about personal and corporate finance; providing entertainment

information in the fields of news, editorials and opinions concerning current events, weather, sports, entertainment news and information in the fields of celebrities, movies stars, movies and television shows, fashion wear, personal and corporate finance, music, personal growth and motivation, and self-discovery, general health and well-being, healthy lifestyle, travel, parenting, medical and social science, technological inventions and innovations, pop culture and urban culture, and wellness provided via a website; providing an online publication in the nature of a newsletter in the field of finance that is transmitted via a subscription service for use in providing analytics, alerts, and forecasts of financial and economic data via market research and statistical analysis tools; online publication of electronic books and journals; electronic desktop publishing; online browsing services for electronic publication, all in the nature of publishing of electronic publications; providing online electronic publications, not downloadable, all in the nature of publishing of electronic publications; online browsing services for electronic images, namely, providing a website featuring non-downloadable photographs; publishing of electronic publications in the nature of providing searchable books, magazines and periodicals; translation of books, magazines and periodicals; leisure activity and entertainment information; providing information in the field of recreational sports and activities and personal physical fitness; providing TV program information; providing online videos featuring news, commentary, weather, sports, entertainment, fashion, finance, food, music, inspiration, health, lifestyle, travel, parenting, science, technology, culture and wellness, not downloadable; providing films, not downloadable, via video-on-demand services; providing TV programs, not downloadable, via video-on-demand services; providing online music, not downloadable; online video gaming services; organization of sports competitions and electronic games competitions; arranging and conducting of educational conferences in the fields of technology and current events; organization of exhibitions in the fields of art, fashion, and architecture for cultural or educational purposes; production of film, video and production of video discs; planning and production of recreational TV program; news reporters services; editing, publication, search services in the nature of library services, subscription services in the nature of publishing subscription periodicals, and translation services for books, magazines and periodicals

Class 42

(5) Design and development of computer hardware and software; computer services, namely, creating computer network-based indexes of information available on computer networks for others; providing internet search engines for searching and retrieving information, websites, and other resources available on computer networks for others; providing search engines for the Internet; search engine design services; providing customized online web pages featuring user-defined information, which includes search engines and online web links to other websites; online cartography and mapping services; mapping services, namely, providing links to geographic information, map images, and trip routing via a website; computer services, namely, non-downloadable computer software provided online for spam filtering, firewall protection, and parental control; providing temporary use of web application software and computer software that allows users to locate other game players and play games over communication networks via a website; platform as a service (PAAS) featuring computer software platforms for use in group communication, namely instant messaging, peer-to-peer file sharing, searching and posting of text messages and digital images and photographs, and videos featuring education and entertainment content, and multimedia content among users; computer services, namely, creating an on-line virtual computer environment for sports betting; providing search engines for obtaining data featuring information in the fields of news, commentary, weather, sports, entertainment, fashion, finance, music, inspiration, health, lifestyle, travel, parenting, science, technology, culture, and wellness via the internet; computer animation design; computer engineering drawing services; computer programming; computer software design; updating of computer software; maintenance

of computer software; rental of computer software; consultancy on computer software design; computer software consultancy; computer system analysis; computer system design; installation of computer software; duplication of computer programs; computer virus protection services; design and development of computer software for creating maps; providing temporary use of nondownloadable online computer software, namely, software for processing electronic media data; conversion of data or documents from physical to electronic media; conversion of computer programs and data from one media to another; rental of network server space; rental of web servers; planning and construction of websites; creating and maintaining websites for others; providing internet search engines; web page design; web hosting; creating and maintaining web pages for others; providing consulting in the field of computer technology via a global computer network; monitoring of computer systems by remote access; monitoring of computer systems to detect breakdowns; monitoring of computer systems for detecting unauthorized access or data breach; online electronic data storage; electronic storage of emails, of digital music, of photographic images, of documents, of files and of multimedia audio and video files; computer data backup; off-site data backup; information technology (IT) consultancy, namely consultancy in the field of computer programming, computer software, computer system integration, the design and development of computer hardware and software, computer database programs, and cloud computing; providing information on computer technology and programming via a web site; cloud computing featuring software for use in database management; web site design consultancy; software as a service [SaaS] featuring software for providing a search engine, providing advertising, providing information in the field of fantasy sports, providing news information, providing video content, providing non-downloadable online games and contests via a multimedia platform; outsourcing service providers in the field of computer technology and software development; creating and designing website-based indexes of information for others [information technology services]; platform as a service [PaaS] featuring computer software platforms for advertising, programmatic advertising, providing a search engine, and providing information in the fields of current events, news, commentary, weather, sports, entertainment, fashion, finance, music, inspiration, health, lifestyle, travel, parenting, science, technology, culture, wellness, advertising, fantasy sports, video content and online multimedia platforms; product development; providing clothing design information; dress designing; providing information on fashion commodity design; authenticating works of art; meteorological information; development and design of mobile applications; technical assistance regarding the operating and managing of websites for others

Class 45

(6) Legal services; security services for the physical protection of tangible property and individuals; Social networking services; astrology forecasts; fortune telling; dating services; guidance and counselling in the field of anti-online bullying guidance, marriage guidance counselling, bereavement counselling, counselling relating to spiritual direction; information relating to fashion coordination services for individuals; personal wardrobe styling consultancy; providing online socializing and dating services via correspondence; providing dating and matchmaking services via the internet; providing dating information via the internet; computer dating; Astrology forecasts; fortune telling; dating services; online social networking services; providing information on fashion; personal styling consultation; providing online socializing and dating services via correspondence; providing dating and matchmaking services via the internet; providing dating information via the internet

Claims

Priority Filing Date: August 09, 2019, Country or Office: JAMAICA, Application No: 078381 in association with the same kind of goods; August 09, 2019, Country or Office: JAMAICA, Application No: 078381 in association with the same kind of services (1); August 09, 2019, Country

or Office: JAMAICA, Application No: 078381 in association with the same kind of services (2); August 09, 2019, Country or Office: JAMAICA, Application No: 078381 in association with the same kind of services (6); August 09, 2019, Country or Office: JAMAICA, Application No: 078381 in association with the same kind of services (4); August 09, 2019, Country or Office: JAMAICA, Application No: 078381 in association with the same kind of services (5); August 09, 2019, Country or Office: JAMAICA, Application No: 078381 in association with the same kind of services (3)

Application Number 1,986,636
Language of Application English

Filing Date 2019-09-25

APPLICANT AND AGENT DETAILS

Applicant

BASF Agro B.V. Arnhem (NL),
Zweigniederlassung Freienbach
Huobstrasse 3
Pfäffikon, SZ
SWITZERLAND

Agent

ROBIC
630, boul. René-Lévesque Ouest, 20e étage,
Montréal, QUEBEC, H3B1S6

TRADEMARK DETAILS

SMOULDER

Trademark Type

Standard Characters

Goods

Class 01

(1) Chemicals used in agriculture, horticulture and forestry, especially plant fortifying preparations, chemical or biological preparations for stress management in plants, plant growth regulating preparations, chemical preparations for the treatment of seeds, genes of seeds for agricultural production.

Class 05

(2) Preparations for destroying and combating vermin; insecticides, fungicides, herbicides, pesticides.

Application Number 1,986,643
Language of Application English

Filing Date 2019-09-25

APPLICANT AND AGENT DETAILS

Applicant

Wella International Operations Switzerland Sàrl
Chemin Louis-Hubert 1-3
1213 PETIT-LANCY
SWITZERLAND

Agent

BERESKIN & PARR LLP/S.E.N.C.R.L., S.R.L.
SCOTIA PLAZA, 40 KING STREET WEST,
40th FLOOR, TORONTO, ONTARIO, M5H3Y2

TRADEMARK DETAILS

BLONDOR BASE BREAKER

Trademark Type

Standard Characters

Goods

Class 03

Hair lotions, hair tinting, bleaching, dyeing and coloring preparations

Application Number 1,986,675
Language of Application English

Filing Date 2019-09-25

APPLICANT AND AGENT DETAILS

Applicant

The Gillette Company LLC
One Gillette Park
Boston, MA 02127
UNITED STATES OF AMERICA

Agent

TORYS LLP
SUITE 3000, 79 WELLINGTON ST. W., BOX
270, TD CENTRE, TORONTO, ONTARIO,
M5K1N2

TRADEMARK DETAILS

GILLETTE BLACK

Trademark Type

Standard Characters

Goods

Class 08

Razors and razor blades; dispensers, cassettes, holders, and cartridges, all specifically designed for and containing razor blades

Application Number 1,986,681
Language of Application English

Filing Date 2019-09-25

APPLICANT AND AGENT DETAILS

Applicant

The Gillette Company LLC
One Gillette Park
Boston, MA 02127
UNITED STATES OF AMERICA

Agent

TORYS LLP
SUITE 3000, 79 WELLINGTON ST. W., BOX
270, TD CENTRE, TORONTO, ONTARIO,
M5K1N2

TRADEMARK DETAILS

Trademark Type

Design

Visual Representation



Goods

Class 08

Razors and razor blades; dispensers, cassettes, holders, and cartridges, all specifically designed for and containing razor blades

Application Number 1,987,172
Language of Application English

Filing Date 2019-09-26

APPLICANT DETAILS

Applicant

TOWN OF FAIRVIEW
P.O. BOX 730,
PROVINCIAL BUILDING,
FAIRVIEW,
ALBERTA
T0H1L0

TRADEMARK DETAILS

Trademark Type

Design

Visual Representation



Colour Claim

Colour claimed as a feature of the trademark. The words "Fairview" and "Heart of the Peace" are black. The left arc shaped design above the letter "F" is dark green at the top edge of the arc and light green for the lower part of the arc. The right arc shaped design above the letter "F" and partially the letter "a" is dark blue at the top edge of the arc and light blue for the lower part of the arc. The line to the left of the words "Heart of the Peace" is light green, same colour as the lower left arc area.

Services

Class 35

(1) preparing income tax reports

Class 37

(2) municipal road and sidewalk maintenance services

Class 39

(3) public utility services in the form of water distribution

Application Number 1,987,236
Language of Application English

Filing Date 2019-09-26

APPLICANT AND AGENT DETAILS

Applicant

BUNGE OILS, INC.
11720 Borman Drive
St. Louis, MO 63146
UNITED STATES OF AMERICA

Agent

MCMILLAN LLP
BROOKFIELD PLACE, SUITE 4400, BAY
WELLINGTON TOWER, 181 BAY STREET,
TORONTO, ONTARIO, M5J2T3

TRADEMARK DETAILS

VREAM

Trademark Type

Standard Characters

Goods

Class 29

Shortening, margarine, edible oils, edible fats

Application Number 1,987,242
Language of Application English

Filing Date 2019-09-26

APPLICANT AND AGENT DETAILS

Applicant

CANADELLE LIMITED PARTNERSHIP
4405 Metropolitan Boulevard East,
Montreal
QUEBEC
H1R1Z4

Agent

GOWLING WLG (CANADA) LLP
1 PLACE VILLE MARIE, 37TH FLOOR/37E
ETAGE, MONTREAL, QUEBEC, H3B3P4

TRADEMARK DETAILS

FABULOUS FEEL

Trademark Type

Standard Characters

Goods

Class 25

Bras, panties, underwear, undergarments, hosiery.

Application Number 1,987,243
Language of Application English

Filing Date 2019-09-26

APPLICANT AND AGENT DETAILS

Applicant

CANADELLE LIMITED PARTNERSHIP,
4405 Metropolitan Boulevard East,
Montreal,
QUEBEC
H1R1Z4

Agent

GOWLING WLG (CANADA) LLP
1 PLACE VILLE MARIE, 37TH FLOOR/37E
ETAGE, MONTREAL, QUEBEC, H3B3P4

TRADEMARK DETAILS

REFINED GLAMOUR

Trademark Type

Standard Characters

Goods

Class 25

Bras, panties, underwear, undergarments, hosiery.

Application Number 1,987,275
Language of Application English

Filing Date 2019-09-26

APPLICANT AND AGENT DETAILS

Applicant

Microsoft Corporation
One Microsoft Way
Redmond, WA 98052-6399
UNITED STATES OF AMERICA

Agent

BERESKIN & PARR LLP/S.E.N.C.R.L., S.R.L.
SCOTIA PLAZA, 40 KING STREET WEST,
40th FLOOR, TORONTO, ONTARIO, M5H3Y2

TRADEMARK DETAILS

SURFACE AUDIO

Trademark Type

Standard Characters

Goods

Class 09

Computer software for operating system programs.

Application Number 1,987,405
Language of Application English

Filing Date 2019-09-27

APPLICANT AND AGENT DETAILS

Applicant

Tee Turtle, LLC
6200 Pershall Road
Hazelwood, Missouri 63042
UNITED STATES OF AMERICA

Agent

VANTEK INTELLECTUAL PROPERTY LLP
(AKA D/B/A VANTEK IP LLP)
101 - 1001 West Broadway, Suite 380,
Vancouver, BRITISH COLUMBIA, V6H4E4

TRADEMARK DETAILS

UNSTABLE GAMES

Trademark Type

Standard Characters

Goods

Class 25

(1) Shirts; tank tops; sweatshirts; pants; leggings; socks; underwear; hats.

Class 28

(2) Board games; card games; dice games; party games; tabletop games; stuffed and plush toys; toy figures.

Claims

Priority Filing Date: April 23, 2019, Country or Office: UNITED STATES OF AMERICA, Application No: 88/398,872 in association with the same kind of goods (2); April 23, 2019, Country or Office: UNITED STATES OF AMERICA, Application No: 88/398,872 in association with the same kind of goods (1)

Application Number 1,987,443
Language of Application English

Filing Date 2019-09-27

APPLICANT AND AGENT DETAILS

Applicant

BUNGE OILS, INC.
11720 Borman Drive
St. Louis, MO 63146
UNITED STATES OF AMERICA

Agent

MCMILLAN LLP
BROOKFIELD PLACE, SUITE 4400, BAY
WELLINGTON TOWER, 181 BAY STREET,
TORONTO, ONTARIO, M5J2T3

TRADEMARK DETAILS

VREAMAY

Trademark Type

Standard Characters

Goods

Class 29

Shortening, margarine, edible oils, edible fats

Application Number 1,987,510
Language of Application English

Filing Date 2019-09-27

APPLICANT DETAILS

Applicant

Kristi and Michael McBride
20 Forest Road
St. John's
NEWFOUNDLAND AND LABRADOR
A1C2C1

TRADEMARK DETAILS

STORM BREWING

Trademark Type

Standard Characters

Goods

Class 32

beer

Services

Class 43

beer brewing services; brewing of beer;

Application Number 1,987,673
Language of Application English

Filing Date 2019-09-30

APPLICANT AND AGENT DETAILS

Applicant

Yahoo Inc.
22000 AOL Way
Dulles, VA 20166
UNITED STATES OF AMERICA

Agent

BERESKIN & PARR LLP/S.E.N.C.R.L., S.R.L.
SCOTIA PLAZA, 40 KING STREET WEST,
40th FLOOR, TORONTO, ONTARIO, M5H3Y2

TRADEMARK DETAILS

Y!FINANCE

Trademark Type

Standard Characters

Goods

Class 09

Computer software for electronic transmission of voice messages, text messages, electronic mail, digital images and photographs, digital video and multimedia content, and electronically stored documents via a global computer network; computer software for providing online chat rooms and electronic bulletin boards for transmission of messages among users in the field of general interest; computer software for providing multiple-user access to a computer network for the dissemination of a wide range and variety of information; downloadable podcasts in the fields of news, commentary, finance, money and business; downloadable films and television programs featuring news, commentary, finance, money and business provided via a video-on-demand service; downloadable mobile applications for viewing online programs, text, images, multimedia content and videos in the fields of news, editorials and opinions concerning current events, personal and corporate finance, money and business; downloadable mobile application featuring software for use in group communication, namely instant messaging, social media, peer-to-peer sharing of digital text and digital images, video and multimedia content and searching and posting of digital text and digital image; downloadable mobile applications for accessing information in the fields of news, editorials and opinions concerning current events, personal and corporate finance, foreign currency exchange rates, money lending and financial management planning, and business news and information in the field of finance and blockchain technology and cryptocurrency

Services

Class 36

(1) Insurance; financial affairs and monetary affairs, namely providing information, ratings, reviews and recommendations relating to financial instruments via a web site, stock market information, financial forecasting, financial management and financial analysis services; providing information in the field of money exchange services via a global computer network; providing information in the field of real estate, namely information about real estate appraisals, real estate investments, real estate listings and real estate information via the Internet; personal financial planning and investment advisory services; providing information and advice in the field of personal finance, personal financial investments, stock prices, and the financial aspects of retirement; investment

research services; stock brokerage services, namely, providing users with tools to execute online trades

Class 41

(2) Providing ongoing multimedia entertainment programs broadcast via radio, television, cellular communication, wireless communication, the internet, electronic communications networks, and computer networks in the fields of news, editorials and opinions concerning current events, personal and corporate finance, foreign currency exchange rates, money lending and financial management planning and business news and information in the field of finance and blockchain technology and cryptocurrency; production of video programs for broadcast on computer networks; entertainment services, namely, providing information, statistics and commentary in the fields of education services, namely, providing information, statistics and commentary in the fields of primary level, high school level, college level and university level education courses and institutions, entertainment information and news in the fields of sports celebrities, movie stars, music celebrities, movies and television shows, personal and corporate finance, money, current event news and business via computer networks; provision of videos, film clips, interviews, talk shows, and animation, provided via a website; entertainment services, namely, providing podcasts in the fields of news, editorials and opinions concerning current events, personal and corporate finance, money, and business; entertainment services, namely, providing videos in the fields of news, commentary, finance, money and business; entertainment services, namely, an online talk show in the fields of personal and corporate finance and business; entertainment services in the nature of a video series about personal and corporate finance and money; providing an online publication in the nature of a newsletter in the field of personal and corporate finance that is transmitted via a subscription service for use in providing analytics, alerts, and forecasts of financial and economic data via market research and statistical analysis tools

Claims

Priority Filing Date: September 23, 2019, Country or Office: UNITED STATES OF AMERICA, Application No: 88627199 in association with the same kind of goods; September 23, 2019, Country or Office: UNITED STATES OF AMERICA, Application No: 88627199 in association with the same kind of services (2); September 23, 2019, Country or Office: UNITED STATES OF AMERICA, Application No: 88627199 in association with the same kind of services (1)

Application Number 1,987,747
Language of Application English

Filing Date 2019-09-30

APPLICANT AND AGENT DETAILS

Applicant

SBT Inc.
P.O. Box 4522
Skokie, IL 60076
UNITED STATES OF AMERICA

Agent

MILTONS IP/P.I.
15 Fitzgerald Rd, Suite 200, Ottawa,
ONTARIO, K2H9G1

TRADEMARK DETAILS

Trademark Type

Design

Visual Representation



Goods

Class 24

towels of textile

Application Number 1,987,755
Language of Application English

Filing Date 2019-09-30

APPLICANT AND AGENT DETAILS

Applicant

NewAgco Inc.
320 22nd Street East
Saskatoon
SASKATCHEWAN
S7K0H1

Agent

MLT AIKINS LLP
2100 Livingston Place, 222-3rd Avenue SW,
Calgary, ALBERTA, T2P0B4

TRADEMARK DETAILS

N-CREASE

Trademark Type

Standard Characters

Goods

Class 01

fertilizer additives;

Application Number 1,987,864
Language of Application English

Filing Date 2019-10-01

APPLICANT AND AGENT DETAILS

Applicant

SteriMax Inc.
2770 Portland Drive
Oakville
ONTARIO
L6H6R4

Agent

TORYS LLP
SUITE 3000, 79 WELLINGTON ST. W., BOX
270, TD CENTRE, TORONTO, ONTARIO,
M5K1N2

TRADEMARK DETAILS

TOMVI

Trademark Type

Standard Characters

Goods

Class 05

general anesthetic

Application Number 1,987,873
Language of Application English

Filing Date 2019-10-01

APPLICANT AND AGENT DETAILS

Applicant

NewAgco Inc.
320 22nd Street East
Saskatoon
SASKATCHEWAN
S7K0H1

Agent

MLT AIKINS LLP
2100 Livingston Place, 222-3rd Avenue SW,
Calgary, ALBERTA, T2P0B4

TRADEMARK DETAILS

POWER PHOS

Trademark Type

Standard Characters

Goods

Class 01

fertilizer additives;

Application Number 1,987,906
Language of Application English

Filing Date 2019-10-01

APPLICANT AND AGENT DETAILS

Applicant

Foshan Shuimianyang Home Co., Ltd.
Rm.1, 6F, No.102, W.Longjiang Section,
National Highway 325, Longjiang Town
Shunde, Foshan, 528318
CHINA

Agent

ANITA MAR
dba Trademark Angel , Suite 521, 6-2557
Dougall Avenue, Windsor, ONTARIO, N8X1T5

TRADEMARK DETAILS

MAXZZZ

Trademark Type

Standard Characters

Services

Class 35

Auction services; Import and export agencies; On-line retail department store services; Wholesale services by direct solicitation by sales agents in the field of bedding, bedclothes; Wholesale services through direct solicitation by salespersons directed to end-users featuring of Bedding, bedclothes

Application Number 1,988,561
Language of Application English

Filing Date 2019-10-04

APPLICANT AND AGENT DETAILS

Applicant

4033000, A Wyoming Company
2232 Dell Range Boulevard, Suite 245,
Cheyenne, Wyoming, 82009
UNITED STATES OF AMERICA

Agent

PUSHOR MITCHELL LLP
301 - 1665 ELLIS STREET, KELOWNA,
BRITISH COLUMBIA, V1Y2B3

TRADEMARK DETAILS

Verified

Trademark Type

Standard Characters

Goods

Class 09

(1) Batteries for electronic cigarettes; battery chargers for electronic cigarettes

Class 16

(2) Absorbent sheets of paper or plastic for foodstuff packaging; envelopes; packaging boxes of paper; packaging boxes of cardboard; plastic film for packaging; plastic bubble packs; plastic bags for packaging

Class 20

(3) Boxes of wood or plastic; packaging containers of plastic

Class 34

(4) Cannabidiol [CBD] oil for oral vaporizers for smoking; cartridges sold filled with chemical flavorings in liquid form for electronic cigarettes; cartridges sold filled with propylene glycol for electronic cigarettes; cartridges sold filled with vegetable glycerin for electronic cigarettes; cartridges for electronic cigarettes; chemical flavourings in liquid form used to refill electronic cigarette cartridges; e-cigarettes; electronic cigarettes; liquid nicotine solutions for use in e-cigarettes; liquid solutions for use in electronic cigarettes; oral vaporizers for smoking purposes; tetrahydrocannabinol [THC] oil for electronic cigarettes; tobacco flavourings

Application Number 1,988,603
Language of Application English

Filing Date 2019-10-04

APPLICANT AND AGENT DETAILS

Applicant

Colgate-Palmolive Canada Inc.
Two Morneau Sobeco Centre, 6th Floor
895 Don Mills Road
Toronto
ONTARIO
M3C1W3

Agent

SMART & BIGGAR LLP
1100-150 York street, TORONTO, ONTARIO,
M5H3S5

TRADEMARK DETAILS

CLEAN UP RIGHT

Trademark Type

Standard Characters

Goods

Class 03

Personal care products, namely, non-medicated body and skin cleansing preparations

Application Number 1,988,623
Language of Application English

Filing Date 2019-10-04

APPLICANT AND AGENT DETAILS

Applicant

GIORGIO ARMANI S.P.A.
Via Borgonuovo 11
20121 Milano,
ITALY

Agent

GOWLING WLG (CANADA) LLP
SUITE 2600, 160 ELGIN STREET, OTTAWA,
ONTARIO, K1P1C3

TRADEMARK DETAILS

Trademark Type

Design

Visual Representation

ARMANI
beauty

Goods

Class 03

Cosmetics; perfumes; toilet waters; eau de cologne; makeup; hair preparations and treatments, namely hair care preparations, non-medicated hair treatment preparations for cosmetic purposes; essential oils, namely, essential oils for personal use

Claims

Priority Filing Date: September 30, 2019, Country or Office: EUIPO (EU), Application No: 018130568 in association with the same kind of goods

Application Number 1,988,658
Language of Application English

Filing Date 2019-10-04

APPLICANT DETAILS

Applicant

Ki & Co. Apparel Inc.
8491 Shaughnessy St.
Vancouver,
BRITISH COLUMBIA
V6P3Y1

TRADEMARK DETAILS

KI & CO.

Trademark Type

Standard Characters

Goods

Class 25

Clothing and clothing accessories for children and adults, namely, shirts, sweatshirts, hoodies, and hats.

Application Number 1,988,668
Language of Application English

Filing Date 2019-10-04

APPLICANT AND AGENT DETAILS

Applicant

Société des Produits Nestlé S.A.
Case Postale 353
1800 Vevey,
SWITZERLAND

Agent

BORDEN LADNER GERVAIS LLP
World Exchange Plaza, 100 Queen Street,
Suite 1300, Ottawa, ONTARIO, K1P1J9

TRADEMARK DETAILS

FANCY FEAST PETITES

Trademark Type

Standard Characters

Goods

Class 31

Food for animals, namely, food for pets

Claims

Priority Filing Date: July 19, 2019, Country or Office: UNITED STATES OF AMERICA, Application No: 88/523,564 in association with the same kind of goods

Application Number 1,988,712
Language of Application English

Filing Date 2019-10-04

APPLICANT AND AGENT DETAILS

Applicant

Pure Fishing, Inc.
1900 18th Street
Spirit Lake, IA 51360
UNITED STATES OF AMERICA

Agent

GOWLING WLG (CANADA) LLP
SUITE 1600, 1 FIRST CANADIAN PLACE, 100
KING STREET WEST, TORONTO, ONTARIO,
M5X1G5

TRADEMARK DETAILS

FLUOROSHIELD

Trademark Type

Standard Characters

Goods

Class 28

Fishing line

Claims

Priority Filing Date: September 25, 2019, Country or Office: UNITED STATES OF AMERICA,
Application No: 88/630,846 in association with the same kind of goods

Application Number 1,988,809
Language of Application English

Filing Date 2019-10-07

APPLICANT AND AGENT DETAILS

Applicant

Fox Factory, Inc.
Suite 300
2055 Sugarloaf Circle
Duluth, GA 30097
UNITED STATES OF AMERICA

Agent

DEETH WILLIAMS WALL LLP
150 YORK STREET, SUITE 400, TORONTO,
ONTARIO, M5H3S5

TRADEMARK DETAILS

38

Trademark Type

Standard Characters

Goods

Class 12

Vehicle parts, namely, shock absorbers

Claims

Priority Filing Date: April 08, 2019, Country or Office: UNITED STATES OF AMERICA, Application No: 88/375,784 in association with the same kind of goods

Application Number 1,988,825
Language of Application English

Filing Date 2019-10-07

APPLICANT AND AGENT DETAILS

Applicant

AS America, Inc.
30 Knightsbridge Rd
Piscataway, NJ 08854
UNITED STATES OF AMERICA

Agent

GOWLING WLG (CANADA) LLP
SUITE 2600, 160 ELGIN STREET, OTTAWA,
ONTARIO, K1P1C3

TRADEMARK DETAILS

Trivantage

Trademark Type

Standard Characters

Goods

Class 11

toilet seat

Application Number 1,988,826
Language of Application English

Filing Date 2019-10-07

APPLICANT AND AGENT DETAILS

Applicant

AS America, Inc.
30 Knightsbridge Rd
Piscataway, NJ 08854
UNITED STATES OF AMERICA

Agent

GOWLING WLG (CANADA) LLP
SUITE 2600, 160 ELGIN STREET, OTTAWA,
ONTARIO, K1P1C3

TRADEMARK DETAILS

Evertight

Trademark Type

Standard Characters

Goods

Class 11

toilet seat

Application Number 1,988,859
Language of Application English

Filing Date 2019-10-07

APPLICANT AND AGENT DETAILS

Applicant

Bell Media Inc.
299 Queen Street West
Toronto
ONTARIO
M5V2Z5

Agent

APRIL AVOCATS, S.E.N.C. / APRIL
LAWYERS, G.P.
1, carrefour Alexander-Graham-Bell, Tour A-7 ,
Verdun, QUEBEC, H3E3B3

TRADEMARK DETAILS

BARDOWN

Trademark Type

Standard Characters

Services

Class 35

(1) Advertising the goods and services of others via electronic media and specifically the internet.

Class 38

(2) Providing streaming audio and video such as music, movies, television shows, music videos, news and sports webcasts via a website.

Class 41

(3) Providing entertainment news and information via a website in the field of sports.

Application Number 1,988,890
Language of Application English

Filing Date 2019-10-07

APPLICANT AND AGENT DETAILS

Applicant

CORPORATE RENAISSANCE GROUP INC.
6 Antares Dr. Phase 1, Suite 200
Ottawa
ONTARIO
K2E8A9

Agent

MARY GRIFFITH
2 Bloor Street East, Suite 3500, Toronto,
ONTARIO, M4W1A8

TRADEMARK DETAILS

CRG Report Central

Trademark Type

Standard Characters

Goods

Class 09

Computer software for creating reports and dashboards in financial and business software applications namely budgeting, planning, forecasting, reporting, allocations and activity based planning.

Services

Class 42

computer programming services, and technical support, namely for creating reports and dashboards for budgeting, planning, forecasting, reporting, allocations and activity based planning.

Application Number 1,989,996
Language of Application English

Filing Date 2019-10-11

APPLICANT AND AGENT DETAILS

Applicant

MAONO TECHNOLOGY INC.
24114 SUNSET SKY
KATY, TX 77494
UNITED STATES OF AMERICA

Agent

JERRY CHEN
166 Berwick Cres, Richmond Hill, ONTARIO,
L4C0B4

TRADEMARK DETAILS

Trademark Type

Design

Visual Representation

The logo for Maono features a stylized, bold letter 'M' in a dark grey color. To the right of the 'M', the word 'maono' is written in a lowercase, bold, black sans-serif font.

Goods

Class 09

Computer hardware; computer keyboards; computer mouse; global positioning system (GPS) consisting of computers, computer software, transmitters, receivers, and network interface devices; headphones; microphones; selfie sticks for use with digital cameras; selfie sticks for use with smartphones; projection screens; protective covers for smartphones; smartwatches; video camera stands; tripods for cameras; notebook computers; tablet computer; digital sound processors; audio mixers.

Application Number 1,990,291
Language of Application English

Filing Date 2019-10-15

APPLICANT AND AGENT DETAILS

Applicant

Never Summer Industries, Inc.
3838 Eudora Way
Denver, CO 80207
UNITED STATES OF AMERICA

Agent

MBM INTELLECTUAL PROPERTY LAW LLP
275 SLATER STREET, 14TH FLOOR,
OTTAWA, ONTARIO, K1P5H9

TRADEMARK DETAILS

NEVER SUMMER

Trademark Type

Standard Characters

Goods

Class 19

(1) Portable fabric shelters, namely, fabric cabanas for camping

Class 20

(2) Pillows; sleeping pads; camp beds; camping furniture; camp cushions; sitting pads, namely, portable camping seats; inflatable mattresses for use when camping; camp chairs; camp cots; camp tables; camp kitchens, namely, portable camp kitchens comprised primarily of camping kitchen furniture and also containing sinks and storage space; stools; camp loungers, namely, lounge chairs; travel cushions

Class 21

(3) Non-electric portable coolers; non-electric portable coolers worn as backpacks; coolers, namely, portable ice chests for food and beverages; water bottles, namely, aluminum, plastic, and stainless steel water bottles, sold empty; water containers, namely, jugs; cups; mugs; insulated mugs; non-electric coffee presses; non-electric coffee percolators; drinking flasks

Class 22

(4) Tents; fabric canopies; rain flies for tents; protective liners of fabric for tents; fabric ground cloths for protecting tent floors; unfitted tarps for covering outdoor goods; awnings of textile or synthetic materials; fabric tent covers, namely, tarpaulins for covering tent shelters, namely, tents for eating and camping outdoors; sun shelters, namely, tents for protection from the sun; wind shelters, namely, tents for protection from the wind; hammocks; nylon tie down straps

Class 24

(5) Sleeping bags

Claims

Priority Filing Date: April 16, 2019, Country or Office: UNITED STATES OF AMERICA, Application No: 88/388,763 in association with the same kind of goods (5); April 16, 2019, Country or Office: UNITED STATES OF AMERICA, Application No: 88/388,763 in association with the same kind of

goods (4); April 16, 2019, Country or Office: UNITED STATES OF AMERICA, Application No: 88/388,763 in association with the same kind of goods (3); April 16, 2019, Country or Office: UNITED STATES OF AMERICA, Application No: 88/388,763 in association with the same kind of goods (2)

Application Number 1,990,466
Language of Application French

Filing Date 2019-10-16

APPLICANT AND AGENT DETAILS

Applicant

Pernod Ricard Winemakers Pty Ltd
Level 3, 167 Fullarton Road
Dulwich, South Australia 5065,
AUSTRALIA

Agent

LAVERY, DE BILLY, LLP
1 Place Ville Marie, Suite 4000, Montréal,
QUEBEC, H3B4M4

TRADEMARK DETAILS

Trademark Type

Design

Visual Representation

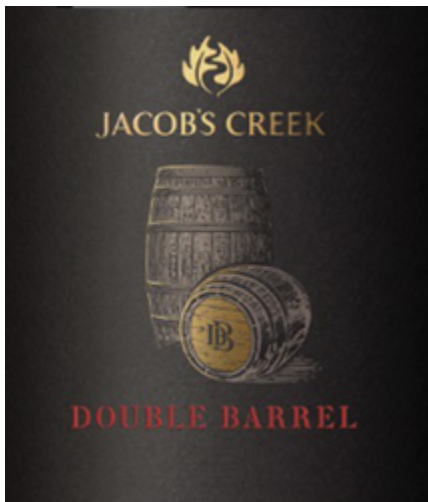

Colour Claim

Colour is claimed as a feature of the trademark. The colours being claimed are black, gold, brown and red. The background of the trademark is black. The leaves and the terms JACOB'S CREEK are gold. The barrels are brown. The terms DOUBLE BARREL are red.

La couleur est revendiquée comme caractéristique de la marque de commerce. Les couleurs revendiquées sont le noir, l'or, le brun et le rouge. L'arrière-plan de la marque de commerce est noir. Les feuilles et les termes JACOB'S CREEK sont or. Les fûts sont bruns. Les termes DOUBLE BARREL sont rouges.

Goods

Class 33

Vins.

Application Number 1,990,563
International Registration Number 1493384
Language of Application English

Filing Date 2019-06-24

APPLICANT AND AGENT DETAILS

Applicant

ALDO NASI; RIFAT NASI
Yildiz Posta Cad. Vefabey Sok.
Yesil Apt. B Blok No:7 K:4 D:13
Gayrettepe Besiktas
TR-34349 Istanbul
TURKEY

Agent

BERESKIN & PARR LLP/S.E.N.C.R.L., S.R.L.
SCOTIA PLAZA, 40 KING STREET WEST,
40th FLOOR, TORONTO, ONTARIO, M5H3Y2

TRADEMARK DETAILS

Trademark Type

Design

Visual Representation



Trademark Description

Dayson extra.

Colour Claim

Colour is claimed as a feature of the trademark. The words "DAYSON EXTRA" are in black on a white background with a red, white and blue border.

Goods

Class 01

(1) Polyurethane mastic, unprocessed artificial resins, starch paste for industrial purposes, filling paste for walls.

Class 02

(2) paint for industrial equipment and machinery, paint for use in the manufacture of furniture, anticorrosive oils as additives to surface coatings; thinners for paint, paint thickeners, natural resins.

Class 03

(3) Emery, emery paper.

Class 17

(4) Adhesive tapes other than stationery and not for medical or household purposes, namely, adhesive tapes for floor coverings, carpets and dado rails, adhesive bands other than stationery and not for medical or household purposes, namely, insulating tape and band, adhesive sealant, masking tape, masking tapes used in construction, insulating paint, polyurethane sealant, polyurethane foam sheeting, polyurethane foam sheeting for use as building insulation

Application Number 1,992,243
Language of Application English

Filing Date 2019-10-24

APPLICANT DETAILS

Applicant

Erin Stinnen
Jason Shivers
2341 Ottawa St
Regina
SASKATCHEWAN
S4P1R2

TRADEMARK DETAILS

Trademark Type

Design

Visual Representation



Goods

Class 25

athletic clothing

Application Number 1,992,586
Language of Application English

Filing Date 2019-10-28

APPLICANT AND AGENT DETAILS

Applicant

IGT
9295 Prototype Drive
Reno, NV 89521
UNITED STATES OF AMERICA

Agent

COLLEEN CAISSIE-DUPUIS
(c/o IGT Canada Solutions ULC), 328 Urquhart
Avenue, Moncton, NEW BRUNSWICK,
E1H2R6

TRADEMARK DETAILS

WILD SWITCH

Trademark Type

Standard Characters

Goods

Class 28

Gaming machines, namely, devices which accept a wager; Reconfigurable casino and lottery gaming equipment, namely, gaming machines; Lottery tickets; lottery cards; scratch cards for playing lottery games

Application Number 1,992,587
Language of Application English

Filing Date 2019-10-28

APPLICANT AND AGENT DETAILS

Applicant

IGT
9295 Prototype Drive
Reno, NV 89521
UNITED STATES OF AMERICA

Agent

COLLEEN CAISSIE-DUPUIS
(c/o IGT Canada Solutions ULC), 328 Urquhart
Avenue, Moncton, NEW BRUNSWICK,
E1H2R6

TRADEMARK DETAILS

ZAP ZONE

Trademark Type

Standard Characters

Goods

Class 28

(1) Gaming machines, namely, devices which accept a wager; Reconfigurable casino and lottery gaming equipment, namely, gaming machines

(2) Lottery tickets; lottery cards; scratch cards for playing lottery games

Claims

Priority Filing Date: October 15, 2019, Country or Office: UNITED STATES OF AMERICA,
Application No: 88654631 in association with the same kind of goods (1)

Application Number 1,992,588
Language of Application English

Filing Date 2019-10-28

APPLICANT AND AGENT DETAILS

Applicant

IGT
9295 Prototype Drive
Reno, NV 89521
UNITED STATES OF AMERICA

Agent

COLLEEN CAISSIE-DUPUIS
(c/o IGT Canada Solutions ULC), 328 Urquhart
Avenue, Moncton, NEW BRUNSWICK,
E1H2R6

TRADEMARK DETAILS

GLORIOUS FORTUNES

Trademark Type

Standard Characters

Goods

Class 28

- (1) Gaming machines, namely, devices which accept a wager; Reconfigurable casino and lottery gaming equipment, namely, gaming machines
(2) Lottery tickets; lottery cards; scratch cards for playing lottery games

Claims

Priority Filing Date: October 15, 2019, Country or Office: UNITED STATES OF AMERICA,
Application No: 88654640 in association with the same kind of goods (1)

Application Number 1,992,590
Language of Application English

Filing Date 2019-10-28

APPLICANT AND AGENT DETAILS

Applicant

IGT
9295 Prototype Drive
Reno, NV 89521
UNITED STATES OF AMERICA

Agent

COLLEEN CAISSIE-DUPUIS
(c/o IGT Canada Solutions ULC), 328 Urquhart
Avenue, Moncton, NEW BRUNSWICK,
E1H2R6

TRADEMARK DETAILS

ANCIENT WEALTH

Trademark Type

Standard Characters

Goods

Class 28

(1) Gaming machines, namely, devices which accept a wager; Reconfigurable casino and lottery gaming equipment, namely, gaming machines

(2) Lottery tickets; lottery cards; scratch cards for playing lottery games

Claims

Priority Filing Date: October 15, 2019, Country or Office: UNITED STATES OF AMERICA,
Application No: 88654647 in association with the same kind of goods (1)

Application Number 1,992,608
Language of Application English

Filing Date 2019-10-28

APPLICANT DETAILS

Applicant

Jessica Six
41595 Brennan Road (Box 360)
Brackendale
BRITISH COLUMBIA
V0N1H0

TRADEMARK DETAILS

my ZEN bear

Trademark Type

Standard Characters

Goods

Class 28

educational toys; electronic learning toys; musical toys; plush toys; stuffed and plush toys; talking toys;

Application Number 1,992,773
Language of Application English

Filing Date 2019-10-29

APPLICANT AND AGENT DETAILS

Applicant

CHINA TOBACCO HEBEI INDUSTRIAL CO.,
LTD
NO.1, WEI MING SOUTH STREET
QIAOXI DISTRICT
SHIJIAZHUANG CITY
HEBEI PROVINCE,
CHINA

Agent

JUNYI CHEN
(Blaney McMurtry LLP), Barristers & Solicitors,
2 Queen Street East, Suite 1500, Toronto,
ONTARIO, M5C3G5

TRADEMARK DETAILS

Trademark Type

Design

Visual Representation



Goods

Class 34

chewing tobacco; cigarette tips; cigarettes; cigarillos; cigars; electronic cigarettes; herbal molasses as a tobacco substitute; herbs for smoking; herbs for use as tobacco substitutes; liquid solutions for use in electronic cigarettes; pipes for smoking mentholated tobacco substitutes; tobacco

Application Number 1,993,083
Language of Application English

Filing Date 2019-10-30

APPLICANT AND AGENT DETAILS

Applicant

Beiersdorf AG
Unnastrasse 48
Hamburg, 20253
GERMANY

Agent

GOWLING WLG (CANADA) LLP
SUITE 1600, 1 FIRST CANADIAN PLACE, 100
KING STREET WEST, TORONTO, ONTARIO,
M5X1G5

TRADEMARK DETAILS

NIVEA ORANGE & AVOCADO OIL

Trademark Type

Standard Characters

Goods

Class 03

cosmetic bath body wash; cosmetic shower body wash;

Application Number 1,993,085
Language of Application English

Filing Date 2019-10-30

APPLICANT AND AGENT DETAILS

Applicant

Beiersdorf AG
Unnastrasse 48
Hamburg, 20253
GERMANY

Agent

GOWLING WLG (CANADA) LLP
SUITE 1600, 1 FIRST CANADIAN PLACE, 100
KING STREET WEST, TORONTO, ONTARIO,
M5X1G5

TRADEMARK DETAILS

NIVEA ROSE & ALMOND OIL

Trademark Type

Standard Characters

Goods

Class 03

cosmetic bath body wash; cosmetic shower body wash;

Application Number 1,993,101
Language of Application English

Filing Date 2019-10-30

APPLICANT AND AGENT DETAILS

Applicant

Plexus Worldwide, LLC
9145 E. Pima Center Parkway
Scottsdale, AZ 85258
UNITED STATES OF AMERICA

Agent

DICKINSON WRIGHT LLP
199 Bay Street, Suite 2200, P.O. Box 447,
Commerce Court : Postal Station, Toronto,
ONTARIO, M5L1G4

TRADEMARK DETAILS

PROBIO 5

Trademark Type

Standard Characters

Goods

Class 05

dietary and nutritional supplements for general health and wellbeing;

Application Number 1,993,104
Language of Application English

Filing Date 2019-10-30

APPLICANT AND AGENT DETAILS

Applicant

Plexus Worldwide, LLC
9145 E. Pima Center Parkway
Scottsdale, AZ 85258
UNITED STATES OF AMERICA

Agent

DICKINSON WRIGHT LLP
199 Bay Street, Suite 2200, P.O. Box 447,
Commerce Court : Postal Station, Toronto,
ONTARIO, M5L1G4

TRADEMARK DETAILS

PROBIO 7

Trademark Type

Standard Characters

Goods

Class 05

dietary and nutritional supplements for general health and wellbeing;

Application Number 1,993,925
Language of Application English

Filing Date 2019-11-04

APPLICANT AND AGENT DETAILS

Applicant

ELECTROLUX HOME PRODUCTS, INC.
10200 David Taylor Drive
Electrolux NA, Inc. Legal Department
Charlotte, NC 28262
UNITED STATES OF AMERICA

Agent

MILLER IP LAW
84 Neilson Drive, Toronto, ONTARIO, M9C1V7

TRADEMARK DETAILS

PureAir Produce Keeper

Trademark Type

Standard Characters

Goods

Class 11

Ethylene gas absorbing and purification units and replacement cartridges therefor for use in refrigerators and coolers for preservation purposes of food, bread, fruits and vegetables; Filters for the absorption of ethylene gas for use in refrigerators and coolers for preservation purposes of food, bread, fruits and vegetables; Filters for the absorption of ethylene gas for use in a produce drawer; Filters for the absorption of ethylene gas for use in a crisper drawer; Filters for the absorption of ethylene gas for use in a produce bin and basket

Claims

Priority Filing Date: October 17, 2019, Country or Office: UNITED STATES OF AMERICA, Application No: 88/657,939 in association with the same kind of goods

Application Number 1,994,307
Language of Application English

Filing Date 2019-11-06

APPLICANT DETAILS

Applicant

Indigenous Bloom Corp.
1425 McCurdy Rd E
Kelowna
BRITISH COLUMBIA
V1P1B4

TRADEMARK DETAILS

Trademark Type

Design

Visual Representation



Colour Claim

Colour is claimed as a feature of the trademark. The letter "B" is black and two leaves in it are green. There are three "C" lookalike of the color black, red & dark yellow.

Goods

Class 05

(1) cannabis oil for the treatment of cancer; medicinal cannabis for temporary relief of seizures; medicinal cannabis for the relief of nausea caused by chemotherapy; medicinal cannabis for the relief of nerve pain; medicinal cannabis for the treatment of muscle spasms caused by multiple sclerosis

Class 34

(2) cannabis grinders; cannabis oil for electronic cigarettes; cannabis oil for oral vaporizers for smoking; dried cannabis

Application Number 1,994,584
International Registration Number 1496615
Language of Application English

Filing Date 2019-10-02

APPLICANT AND AGENT DETAILS

Applicant

HP Hewlett Packard Group LLC
10300 Energy Drive
Spring TX 77389
UNITED STATES OF AMERICA

Agent

GOWLING WLG (CANADA) LLP
SUITE 1600, 1 FIRST CANADIAN PLACE, 100
KING STREET WEST, TORONTO, ONTARIO,
M5X1G5

TRADEMARK DETAILS

HPE TECHNOMICS

Trademark Type

Standard Characters

Goods

Class 09

Downloadable computer software for business management asset tracking to be able to plan for, acquire, use, and adapt their IT infrastructure to emerging computer technologies; downloadable computer software for creating and tracking lease-purchase financing agreements; downloadable computer software to monitor lease-purchase financing agreement pricing, monitor and transfer payments, monitor credit check and credit rating processes, as well as process the lease-purchase financing agreement for use in an application programming interface (API)

Services

Class 36

Financing of purchases; providing lease financing for IT equipment and computer software; leasepurchase financing.

Claims

Priority Filing Date: April 05, 2019, Country or Office: UNITED STATES OF AMERICA, Application No: 88372711 in association with the same kind of goods and in association with the same kind of services

Application Number 1,994,942
Language of Application English

Filing Date 2019-11-08

APPLICANT AND AGENT DETAILS

Applicant

Henkel Corporation
One Henkel Way
Rocky Hill, CT 06067
UNITED STATES OF AMERICA

Agent

SMART & BIGGAR LLP
SUITE 900, 55 METCALFE STREET, P.O.
BOX 2999, STATION D, OTTAWA, ONTARIO,
K1P5Y6

TRADEMARK DETAILS

DIAL TANGERINE & GUAVA

Trademark Type

Standard Characters

Goods

Class 03

Bar soap; Non-medicated liquid soap, Hair and body wash

Application Number 1,994,972
Language of Application English

Filing Date 2019-11-08

APPLICANT AND AGENT DETAILS

Applicant

Henkel Corporation
One Henkel Way
Rocky Hill, CT 06067
UNITED STATES OF AMERICA

Agent

SMART & BIGGAR LLP
SUITE 900, 55 METCALFE STREET, P.O.
BOX 2999, STATION D, OTTAWA, ONTARIO,
K1P5Y6

TRADEMARK DETAILS

DIAL COCONUT WATER MANGO

Trademark Type

Standard Characters

Goods

Class 03

Bar soap; Non-medicated liquid soap, Hair and body wash

Application Number 1,994,982
Language of Application English

Filing Date 2019-11-08

APPLICANT AND AGENT DETAILS

Applicant

Henkel Corporation
One Henkel Way
Rocky Hill, CT 06067
UNITED STATES OF AMERICA

Agent

SMART & BIGGAR LLP
SUITE 900, 55 METCALFE STREET, P.O.
BOX 2999, STATION D, OTTAWA, ONTARIO,
K1P5Y6

TRADEMARK DETAILS

DIAL VANILLA HONEY

Trademark Type

Standard Characters

Goods

Class 03

Bar soap; Non-medicated liquid soap, Hair and body wash

Application Number 1,995,112
Language of Application English

Filing Date 2019-11-11

APPLICANT AND AGENT DETAILS

Applicant

Wolf Spirit LLC
121 Monroe Street
Eugene, OR 97402
UNITED STATES OF AMERICA

Agent

GOWLING WLG (CANADA) LLP
SUITE 2600, 160 ELGIN STREET, OTTAWA,
ONTARIO, K1P1C3

TRADEMARK DETAILS

PUNCHER'S CHANCE

Trademark Type

Standard Characters

Goods

Class 33

alcoholic cocktails; alcoholic cordials; blended whiskey; bourbon; bourbon whiskey; liqueurs;
prepared alcoholic cocktails; whiskey; whiskey cocktails;

Application Number 1,995,337
Language of Application English

Filing Date 2019-11-12

APPLICANT AND AGENT DETAILS

Applicant

J&E Brothers Holdings, LLC
1449 36th St
Brooklyn, NY 11218
UNITED STATES OF AMERICA

Agent

PIASETZKI NENNIGER KVAS LLP
SUITE 2308, 120 ADELAIDE STREET WEST,
TORONTO, ONTARIO, M5H1T1

TRADEMARK DETAILS

NESTL

Trademark Type

Standard Characters

Goods

Class 24

bed blankets; bed linen; bed sheet sets; comforters; duvet covers; mattress covers; pillow shams;

Application Number 1,995,475
Language of Application English

Filing Date 2019-11-13

APPLICANT AND AGENT DETAILS

Applicant

AS America, Inc.
30 Knightsbridge Rd
Piscataway, NJ 08854
UNITED STATES OF AMERICA

Agent

GOWLING WLG (CANADA) LLP
SUITE 2600, 160 ELGIN STREET, OTTAWA,
ONTARIO, K1P1C3

TRADEMARK DETAILS

EVER-TITE

Trademark Type

Standard Characters

Goods

Class 11

Toilets and toilet seats

Application Number 1,995,719
International Registration Number 1497542
Language of Application English

Filing Date 2019-09-09

APPLICANT AND AGENT DETAILS

Applicant

Edmac Europe NV
Terbekehofdreef 54
B-2610 Antwerpen
BELGIUM

Agent

ROBIC
630, boul. René-Lévesque Ouest, 20e étage,
Montréal, QUEBEC, H3B1S6

TRADEMARK DETAILS

COMPREX

Trademark Type

Standard Characters

Services

Class 35

Retail sale of gas and air compressors, namely electric air compressors, portable air compressors and spare parts, pneumatic tools, namely staplers, nail guns, tire inflators, angle grinders, sandblasting guns, cartridge dispenser guns, grease pumps, paint guns, blow guns, ratchets, sanders, socket wrenches, saws, screwdrivers, dispensers, drills, jackhammers, spray guns, pneumatic hoses and tubing, pipe connectors, fittings, namely metal pipe fittings, metal joinery fittings, metal fittings for compressed air lines, hose fittings of metal, pneumatic valves and inflations nozzles; online retail sale of gas and air compressors, namely electric air compressors, portable air compressors and spare parts, pneumatic tools, namely staplers, nail guns, tire inflators, angle grinders, sandblasting guns, cartridge dispenser guns, grease pumps, paint guns, blow guns, ratchets, sanders, socket wrenches, saws, screwdrivers, dispensers, drills, jackhammers, spray guns, pneumatic hoses and tubing, pipe connectors, fittings, namely metal pipe fittings, metal joinery fittings, metal fittings for compressed air lines, hose fittings of metal, pneumatic valves and inflations nozzles; sales and online wholesale store services featuring gas and air compressors, namely electric air compressors, portable air compressors and spare parts, pneumatic tools, namely staplers, nail guns, tire inflators, angle grinders, sandblasting guns, cartridge dispenser guns, grease pumps, paint guns, blow guns, ratchets, sanders, socket wrenches, saws, screwdrivers, dispensers, drills, jackhammers, spray guns, pneumatic hoses and tubing, pipe connectors, fittings, namely metal pipe fittings, metal joinery fittings, metal fittings for compressed air lines, hose fittings of metal, pneumatic valves and inflation nozzles.

Claims

Priority Filing Date: March 18, 2019, Country or Office: Benelux Office for IP (BOIP), Application No: 1392258 in association with the same kind of services

Application Number 1,996,013
Language of Application English

Filing Date 2019-11-14

APPLICANT AND AGENT DETAILS

Applicant

Eminent Luggage Corp.
No. 40, Chung-Shan 9th Street
Kuei-Jen District, Tainan City, Taiwan
CHINA

Agent

BLAKE, CASSELS & GRAYDON LLP
INTELLECTUAL PROPERTY GROUP, SUITE
4000, COMMERCE COURT WEST, 199 BAY
STREET, TORONTO, ONTARIO, M5L1A9

TRADEMARK DETAILS

Trademark Type

Design

Visual Representation



Goods

Class 18

traveling cases; luggage trunks; briefcases; vanity cases sold empty; wallets; handbags; backpacks; valises; bags for mountaineering; all purpose sport bags; umbrellas

Application Number 1,996,099
Language of Application English

Filing Date 2019-11-14

APPLICANT AND AGENT DETAILS

Applicant

CWachsberg Holdings Inc.
1 Apollo Place
Toronto
ONTARIO
M3J0H2

Agent

BERESKIN & PARR LLP/S.E.N.C.R.L., S.R.L.
SCOTIA PLAZA, 40 KING STREET WEST,
40th FLOOR, TORONTO, ONTARIO, M5H3Y2

TRADEMARK DETAILS

ICON PERFORMANCE

Trademark Type

Standard Characters

Goods

Class 32

antioxidant juice drinks; bottled water; carbonated soft drinks; drinking water; drinking water with vitamins; energy drinks; fruit flavoured drinks; meal replacement drinks; non-alcoholic fruit drinks; sparkling water; spring water; still water;

Application Number 1,996,140
Language of Application English

Filing Date 2019-11-14

APPLICANT DETAILS

Applicant

MONSTER L KARAOKE LTD.
150-10451 Shellbridge Way
Richmond
BRITISH COLUMBIA
V6X2W8

TRADEMARK DETAILS

Monster L Karaoke

Trademark Type

Standard Characters

Services

Class 41

karaoke lounge services; providing karaoke services

Application Number 1,996,743
Language of Application English

Filing Date 2019-11-20

APPLICANT AND AGENT DETAILS

Applicant

4033000, A Wyoming Company
2232 Dell Range Boulevard, Suite 245,
Cheyenne, Wyoming, 82009
UNITED STATES OF AMERICA

Agent

PUSHOR MITCHELL LLP
301 - 1665 ELLIS STREET, KELOWNA,
BRITISH COLUMBIA, V1Y2B3

TRADEMARK DETAILS

Trademark Type

Design

Visual Representation



Goods

Class 09

(1) Batteries for electronic cigarettes; battery chargers for electronic cigarettes

Class 16

(2) Absorbent sheets of paper or plastic for foodstuff packaging; envelopes; packaging boxes of paper; packaging boxes of cardboard; plastic film for packaging; plastic bubble packs; plastic bags for packaging

Class 20

(3) Boxes of wood or plastic; packaging containers of plastic

Class 34

(4) Cannabidiol [CBD] oil for oral vaporizers for smoking; cartridges sold filled with chemical flavorings in liquid form for electronic cigarettes; cartridges sold filled with propylene glycol for electronic cigarettes; cartridges sold filled with vegetable glycerin for electronic cigarettes; cartridges for electronic cigarettes; chemical flavourings in liquid form used to refill electronic cigarette cartridges; e-cigarettes; electronic cigarettes; liquid nicotine solutions for use in e-cigarettes; liquid solutions for use in electronic cigarettes; oral vaporizers for smoking purposes; tetrahydrocannabinol [THC] oil for electronic cigarettes; tobacco flavourings

Application Number 1,996,833
International Registration Number 1499547
Language of Application English

Filing Date 2019-06-18

APPLICANT AND AGENT DETAILS

Applicant

KWS SAAT SE & Co. KGaA
Grimsehlstr. 31
37574 Einbeck
GERMANY

Agent

RIDOUT & MAYBEE LLP
250 University Avenue, 5th Floor, Toronto,
ONTARIO, M5H3E5

TRADEMARK DETAILS

FIELDCUBE

Trademark Type

Standard Characters

Goods

Class 07

(1) agricultural machines and apparatus, namely, crop scouting, field or plot planning, field or plot management and field or plot monitoring machines in the nature of industrial robots; sower machines; agricultural seed planting machine; agricultural spraying machines; atomisers being parts for agricultural crop spraying machines; fertilizer spreading machines; tractor towed agricultural implements, namely, sprayer, fertilizer distributors; swath mower; machines and installations for processing seeds, in particular for cleaning, calibrating, pickling, incrusting, pilling and packaging of seed

Class 09

(2) computer hardware, exclusively related to agricultural, horticulture and forestry; computer software for database management, exclusively related to agriculture, horticulture and forestry; computer software exclusively related to agriculture, horticulture and forestry for field and plot management; mobile computer and data apparatus, exclusively related to agriculture, horticulture and forestry, namely, apparatus for autonomous steering of agricultural machines and implements, for field/plot management, for determination of position and time and transmission relative to GPS receivers; digital electronic controllers for autonomous agricultural seed planting, plant treatment and harvesting machines, exclusively related to agricultural, horticulture and forestry; software for operating computer-operated agricultural seed planting, plant treatment and harvesting machines, exclusively related to agriculture, horticulture and forestry; computer hardware for managing control devices for agricultural machines, exclusively related to agricultural, horticulture and forestry; programmable logic controllers exclusively related to agriculture, horticulture and forestry for electronic apparatus for the remote control of agricultural operations; application software exclusively related to agriculture, horticulture and forestry for apparatus for autonomous steering of agricultural machines and implements, for field/plot management; mobile Apps exclusively related to agriculture, horticulture and forestry, namely, application software for use in connection with the planning and management of agricultural fields; downloadable and recorded application software exclusively related to agriculture, horticulture and forestry for the management and monitoring of plant cultivation virtual reality glasses; software for managing and updating GPS navigation

systems; software to support agricultural measures, namely application software for use in connection with the planning and management of agricultural fields

Services

Class 42

design and development of computer hardware and software in the fields of agriculture, horticulture and forestry; software as a service [SaaS] for planning and management of agricultural fields; electronic data storage services in the fields of agriculture, horticulture and forestry; scientific and technological services and research and design relating thereto, namely, scientific research and development in the fields of agricultural field and plot planning and management; industrial analysis and research services in the field of agriculture; agricultural research in the areas of field and plot planning and management; research relating to plant breeding; design and development of application software for plant cultivation

Claims

Priority Filing Date: December 19, 2018, Country or Office: GERMANY, Application No: 30 2018 030 297 in association with the same kind of goods and in association with the same kind of services

Application Number 1,997,094
International Registration Number 1498952
Language of Application English

Filing Date 2019-10-04

APPLICANT AND AGENT DETAILS

Applicant

Celgene Corporation
86 Morris Avenue
Summit NJ 07901
UNITED STATES OF AMERICA

Agent

GOWLING WLG (CANADA) LLP
SUITE 1600, 1 FIRST CANADIAN PLACE, 100
KING STREET WEST, TORONTO, ONTARIO,
M5X1G5

TRADEMARK DETAILS

ASTOTLEO

Trademark Type

Standard Characters

Goods

Class 05

Pharmaceutical preparations for use in the treatment of cancer and auto-immune diseases, diseases in the fields of oncology, immunology and inflammation; pharmaceutical preparations, namely, cytokine inhibitory drugs; pharmaceutical preparations that modulate the immune system; pharmaceutical preparations, namely, preparations for use in the treatment of tumors; pharmaceutical and biological preparations for immunotherapy, including T-Cell therapy; T-cells for medical purposes; diagnostic kits consisting primarily of cells for medical laboratory use for detecting cancer and auto-immune diseases

Claims

Priority Filing Date: September 26, 2019, Country or Office: UNITED STATES OF AMERICA, Application No: 88632300 in association with the same kind of goods

Application Number 1,997,484
Language of Application English

Filing Date 2019-11-22

APPLICANT AND AGENT DETAILS

Applicant

EssilorLuxottica Canada Inc.
371, Deslauriers
St-Laurent
QUEBEC
H4N1W2

Agent

LAVERY, DE BILLY, LLP
1 Place Ville Marie, Suite 4000, Montréal,
QUEBEC, H3B4M4

TRADEMARK DETAILS

Trademark Type

Design

Visual Representation



Goods

Class 05

(1) Eye care products namely eye drops, contact lens solution, contact lens disinfectants, cleaning agents for contact lenses, ophthalmic preparations;

Class 09

(2) Eyeglasses; sunglasses; contact lenses; swimming goggles, eyeglasses and goggles adapted to protect the eyes from accident and injury, and protective eyewear namely protective eyeglasses and sports eyewear; eyewear accessories namely cases for eyeglasses and sunglasses, chains, straps and cords for eyeglasses and sunglasses, frames for eyeglasses and sunglasses, optical lenses for eyeglasses and sunglasses, drawstring pouches for eyeglasses, sunglasses and contact lenses, carrying cases for eyeglasses, sunglasses and contact lenses, and containers for contact lenses;

Services

Class 35

(1) Retail sale, online retail sale and retail store services featuring optical goods namely eyeglasses, sunglasses, contact lenses, eye care products namely eye drops, contact lens

solution, contact lens disinfectants, cleaning agents for contact lenses, ophthalmic preparations, swimming goggles, eyeglasses and goggles adapted to protect the eyes from accident and injury, and protective eyewear namely protective eyeglasses and sports eyewear, and eyewear accessories;

Class 44

(2) Providing information in the field of eyewear and eye care; optometry services;

Application Number 1,997,546
Language of Application English

Filing Date 2019-11-25

APPLICANT DETAILS

Applicant

Upper Canada Growers Ltd.
921 Concession 2 Rd
Niagara on the Lake
ONTARIO
L0S1J0

TRADEMARK DETAILS

Trademark Type

Design

Visual Representation



Colour Claim

Colour is claimed as a feature of the trademark. The UPPERCASE letters in the words "UPPER CANADA" are dark grey. The stylized letters in the word "Growers" are black, leaf stem is black and the body of the leaf is light green.

Goods

Class 31

live trees; living fruit plants; potted dwarfed trees; scions for fruit tree grafting

Services

Class 44

consultancy services relating to tree planting; tree nurseries; tree nursery services

Application Number 1,997,794
Language of Application English

Filing Date 2019-11-26

APPLICANT AND AGENT DETAILS

Applicant

The Procter & Gamble Company
One Procter & Gamble Plaza
Cincinnati, OH 45202
UNITED STATES OF AMERICA

Agent

WILSON LUE LLP
250 University Avenue, 5th Floor, Toronto,
ONTARIO, M5H3E5

TRADEMARK DETAILS

SWIFFER XL WET MOPPING CLOTHS

Trademark Type

Standard Characters

Goods

Class 03

all purpose cleaning preparations; disposable wipes impregnated with cleansing compounds for use on surface areas;

Application Number 1,997,797
Language of Application English

Filing Date 2019-11-26

APPLICANT AND AGENT DETAILS

Applicant

The Procter & Gamble Company
One Procter & Gamble Plaza
Cincinnati, OH 45202
UNITED STATES OF AMERICA

Agent

WILSON LUE LLP
250 University Avenue, 5th Floor, Toronto,
ONTARIO, M5H3E5

TRADEMARK DETAILS

SWIFFER XL HEAVY DUTY

Trademark Type

Standard Characters

Goods

Class 03

(1) all purpose cleaning preparations; disposable wipes impregnated with cleansing compounds for use on surface areas;

Class 16

(2) disposable paper wipes for household cleaning not impregnated with chemicals or compounds;

Class 21

(3) mops;

Application Number 1,997,827
Language of Application English

Filing Date 2019-11-26

APPLICANT AND AGENT DETAILS

Applicant

International Brotherhood of Boilermakers, Iron
Ship Builders, Blacksmiths, Forgers and
Helpers, and the United Association of
Journeyman and Apprentices of the Plumbing
and Pipe Fitting Industry of the United States
and Canada, in partnership
225 Metcalfe Street, Suite 600
Ottawa
ONTARIO
K2P1P9

Agent

SHELDON S. LAZAROVITZ
31 WESTGATE BOULEVARD, TORONTO,
ONTARIO, M3H1N8

TRADEMARK DETAILS

QUALITY IS IN OUR CONTROL

Trademark Type

Standard Characters

Services

Class 35

labour unions;

Application Number 1,998,551
Language of Application English

Filing Date 2019-11-28

APPLICANT DETAILS

Applicant

Grand Pré Wines Limited
11611 Highway 1
Grand Pre
NOVA SCOTIA
B0P1M0

TRADEMARK DETAILS

Stutz

Trademark Type

Standard Characters

Goods

Class 32

(1) apple juice; apple juice beverages; apple juice drinks; non-alcoholic cider; sweet cider

Class 33

(2) cider; hard cider

Application Number 1,999,318
International Registration Number 1501736
Language of Application English

Filing Date 2019-08-12

APPLICANT AND AGENT DETAILS

Applicant

Lohmann GmbH & Co.KG
Irlicher Str. 55
56567 Neuwied
GERMANY

Agent

NELLIGAN O'BRIEN PAYNE LLP
300-50 O'CONNOR STREET, OTTAWA,
ONTARIO, K1P6L2

TRADEMARK DETAILS

UV-LUX

Trademark Type

Standard Characters

Goods

Class 01

(1) Chemical preparations for sealing, namely, industrial adhesives for use in sealing, adhesives used in industry, namely adhesives for use in the automotive Industry, furniture industry, construction industry, renewable energy industry, electronics industry, medical industry, paper industry, textile industry, plastics industry, and hygiene industry, industrial adhesives in the nature of adhesive compositions with a base of epoxy resins for use in industry, adhesive compounds with a base of epoxy resins for use in the automotive Industry, furniture industry, construction industry, renewable energy industry, electronics industry, medical industry, paper industry, textile industry, plastics industry, and hygiene industry, adhesives for use in the electronics industry, adhesives for the building industry, adhesives for use in the manufacture of furniture, quick bonding adhesives for industrial use for use in the automotive Industry, furniture industry, construction industry, renewable energy industry, electronics industry, medical industry, paper industry, textile industry, plastics industry, and hygiene industry, adherent substances for adhesive tapes for use in the automotive Industry, furniture industry, construction industry, renewable energy industry, electronics industry, medical industry, paper industry, textile industry, plastics industry, and hygiene industry, spirit gum for industrial purposes for use in the automotive Industry, furniture industry, construction industry, renewable energy industry, electronics industry, medical industry, paper industry, textile industry, plastics industry, and hygiene industry, chemical preparations in the nature of glue accelerators, chemical products for the manufacture of adhesives, liquid glues for industrial purposes, adhesives for industrial use in the form of coatings for use in the automotive Industry, furniture industry, construction industry, renewable energy industry, electronics industry, medical industry, paper industry, textile industry, plastics industry, and hygiene industry, adhesives for industrial use for use in bonding materials, none being for use in the printing industry

Class 17

(2) Adhesive tapes, strips, bands and films, for industrial use, adhesive strips for use in industry, duct tapes, self-adhesive tapes, for use in the automotive Industry, furniture industry, construction industry, renewable energy industry, electronics industry, medical industry, paper industry, textile

industry, plastics industry, and hygiene industry, other than stationery and not for medical or household purposes, adhesive coated strips for use in manufacture, adhesive tapes, for technical purposes, for use in the automotive Industry, furniture industry, construction industry, renewable energy industry, electronics industry, medical industry, paper industry, textile industry, plastics industry, and hygiene industry, double sided adhesive tapes [other than for stationery, household or medical use] for use in the automotive Industry, furniture industry, construction industry, renewable energy industry, electronics industry, medical industry, paper industry, textile industry, plastics industry, and hygiene industry, seals, adhesive sealants and expansion joint fillers, namely, sealant compounds for crevices, joints, pipe joint compound, expansion joint fillers, none being for use in the printing industry, all the aforesaid goods containing activatable adhesives

Services**Class 42**

Scientific and technological services, and research and design related thereto in connection with adhesion processes, industrial analysis and industrial research in connection with adhesion processes, design and development of computer hardware and software in connection with adhesion processes, testing, authentication and quality control in connection with adhesion processes, research and development in the field of adhesion processes, research for developing new products in the field of adhesion technology, conducting of chemical analysis for material testing in the field of adhesion technology, none relating to printing

Claims

Priority Filing Date: February 11, 2019, Country or Office: EUIPO (EU), Application No: 018021304 in association with the same kind of goods and in association with the same kind of services

Application Number 1,999,375
International Registration Number 1501540
Language of Application French

Filing Date 2019-09-20

APPLICANT AND AGENT DETAILS

Applicant
EOS IMAGING
10 rue Mercoeur
F-75011 PARIS
FRANCE

Agent
BCF S.E.N.C.R.L./BCF LLP
1100, boul. René-Lévesque Ouest, 25e Étage,
Montréal, QUÉBEC, H3B5C9

TRADEMARK DETAILS

Flex Dose

Trademark Type
Standard Characters

Goods

Class 09

(1) Systems consisting of computers, microscopes, scanners, sensors, software and video display screens, for the display of visual data, the reproduction of sound and images, the 3D reconstruction, the transmission and analysis of optical images in the field of medical imaging; stations for reviewing medical images (scanners, MRIs, mammograms, X-rays) and post-processed images (functional imaging, 3D imaging), namely video display screens; computers and software for measuring clinical parameters for medical clinics in the field of orthopedics; diagnostic software, for planning surgeries, for assessing and tracking various pathologies in the field of orthopedics.

Class 10

(2) Ultrasonic diagnostic instruments and apparatus for medical use; magnetic resonance imaging apparatus; medical X-ray imaging instruments; scanners and sensors for measuring clinical parameters for medical clinics in the field of orthopedics.

Claims

Priority Filing Date: March 25, 2019, Country or Office: FRANCE, Application No: 4536747 in association with the same kind of goods

Application Number 1,999,399
International Registration Number 1501250
Language of Application English

Filing Date 2019-10-02

APPLICANT AND AGENT DETAILS

Applicant

Supfina Grieshaber GmbH & Co. KG
Schmelzegrün 7
77709 Wolfach
GERMANY

Agent

GOWLING WLG (CANADA) LLP
SUITE 2600, 160 ELGIN STREET, OTTAWA,
ONTARIO, K1P1C3

TRADEMARK DETAILS

R-Cell

Trademark Type

Standard Characters

Goods

Class 07

Machines for treatment of surfaces, namely, for metal surface processing and treatment, machine tools for metalworking, namely, for metal surface processing and treatment, grinding machines for metalworking, electric machines and robotic polishers for use in polishing metal, wood, ceramics and plastics, concrete finishing machines, machines for brushing metal, wood, ceramics and plastics, deburring machines, attachments for the aforesaid machines, namely abrasive discs for power-operated grinders and rotary brushes for machines, work piece holders, reducing adaptors, namely reduction gears being parts of machines, structural machine parts for the aforesaid machines.

Services

Class 37

(1) Repair and maintenance of machines for treatment of surfaces as well as of machine tools, grinding machines, machines for polishing, finishing machines as well as of attachments and of machine parts for the aforesaid machines; cleaning of workpieces in the nature of rollers, camshafts, crankshafts, gear shafts, cylindrical clamped spherical rollers, tapered rollers, discs, balls, calottes, balancing shafts, cams, pump cams, eccentric rollers, pump cam shafts, steering rods, steering racks, absorber rods, shock absorber, drive shafts, piston pins and cam rollers, synchronous wheels, pump gear wheels, injection bodies, valve plates, pump bodies, cylinder roller bearings, tapered roller bearings, ball joint bearings, special bearings, shafts and bushings.

Class 40

(2) Treatment of materials, namely grinding, brushing, polishing, blast treatment and superfinishing of roller bearing parts, rollers, camshafts, crank shafts and workpieces of metal, plastic, ceramic and glass in the nature of rollers, camshafts, crankshafts, gear shafts, cylindrical clamped spherical rollers, tapered rollers, discs, balls, calottes, balancing shafts, cams, pump cams, eccentric rollers, pump cam shafts, steering rods, steering racks, absorber rods, shock absorber, drive shafts, piston pins and cam rollers, synchronous wheels, pump gear wheels, injection bodies, valve plates, pump bodies, cylinder roller bearings, tapered roller bearings, ball joint bearings,

special bearings, shafts and bushings; machining services of surfaces; contract manufacturing, for others, of workpieces of metal, in particular roller bearing parts, camshafts, crank shafts; custom manufacture of molded components in particular rollers, camshafts, crankshafts, gear shafts, cylindrical clamped spherical rollers, tapered rollers, discs, balls, calottes, balancing shafts, cams, pump cams, eccentric rollers, pump cam shafts, steering rods, steering racks, absorber rods, shock absorber, drive shafts, piston pins and cam rollers, synchronous wheels, pump gear wheels, injection bodies, valve plates, pump bodies, cylinder roller bearings, tapered roller bearings, ball joint bearings, special bearings, shafts and bushings.

Claims

Priority Filing Date: April 30, 2019, Country or Office: GERMANY, Application No: 30 2019 105 659 in association with the same kind of goods and in association with the same kind of services

Application Number 1,999,453
International Registration Number 1501161
Language of Application English

Filing Date 2019-10-10

APPLICANT AND AGENT DETAILS

Applicant

La Fée LLP
The Coach House,
Bayford Hall
Bayford, Hertford SG13 8PR
UNITED KINGDOM

Agent

PERRY + CURRIER
1300 YONGE STREET, SUITE 500,
TORONTO, ONTARIO, M4T1X3

TRADEMARK DETAILS

LA FÉE

Trademark Type

Standard Characters

Goods

Class 32

Non-alcoholic beverages, namely, fruit drinks, water, and soft drinks; preparations for making beverages, namely, syrups and powders for the preparation of fruit drinks and soft drinks; non-alcoholic preparations for making beverages, namely, syrups, powders, herbs, spices for the preparation of fruit drinks and soft drinks; mineral and aerated waters; fruit beverages and fruit juices; syrups and powders for the preparation of fruit drinks and soft drinks.

Claims

Priority Filing Date: April 24, 2019, Country or Office: UNITED KINGDOM, Application No: UK00003394340 in association with the same kind of goods

Application Number 1,999,847
Language of Application English

Filing Date 2019-12-06

APPLICANT AND AGENT DETAILS

Applicant

Lobna Mamlouk
612-165 Ch De La Côte-Sainte-Catherine
Outremont
QUEBEC
H2V2A7

Agent

SPIEGEL SOHMER INC.
1255, Peel Street, Suite 1000, Montreal,
Attention: IP department, QUEBEC, H3B2T9

TRADEMARK DETAILS

KOMFYBUNS

Trademark Type

Standard Characters

Goods

Class 10

(1) cushions for medical purposes; orthopedic seat cushions;

Class 20

(2) chair cushions; seat cushions

Application Number 1,999,972
Language of Application English

Filing Date 2019-12-06

APPLICANT AND AGENT DETAILS

Applicant

COORS BREWING COMPANY
3939 West Highland Blvd
Milwaukee, Wisconsin 53208
UNITED STATES OF AMERICA

Agent

JOANNE B. NARDI
Joanne Nardi IP Consulting Services Inc., 117
Shadow Falls Drive, Richmond Hill, ONTARIO,
L4E4K2

TRADEMARK DETAILS

Trademark Type

Design

Visual Representation

VIZZY

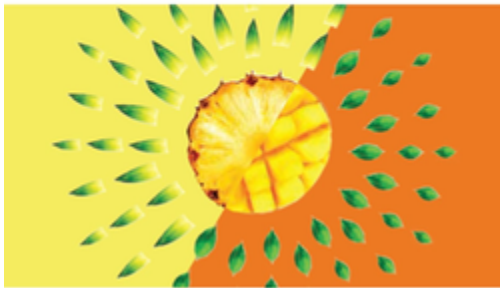

Colour Claim

Colour is claimed as a feature of the trademark. The word VIZZY is dark blue. The left side of the rectangular shape is yellow and the right side is orange. The pineapple and mango designs are yellow, and the pineapple tips and leaves are green.

Goods

Class 33

alcoholic cocktails; alcoholic coolers; alcoholic fruit beverages; alcoholic fruit cocktail drinks; alcoholic fruit drinks; alcoholic fruit-based beverages; alcoholic lemonade; alcoholic malt-based coolers; alcoholic seltzer; hard seltzer; hard seltzers; prepared alcoholic cocktails; vodka seltzer; vodka, flavoured vodka beverages, vodka-based beverages;

Application Number 2,000,010
Language of Application English

Filing Date 2019-12-06

APPLICANT AND AGENT DETAILS

Applicant

Mark Anthony Group Inc.
Unit 100 - 565 Great Northern Way
Vancouver
BRITISH COLUMBIA
V5T0H8

Agent

GOWLING WLG (CANADA) LLP
550 BURRARD STREET, SUITE 2300,
VANCOUVER, BRITISH COLUMBIA, V6C2B5

TRADEMARK DETAILS

BEARFACE ONE ELEVEN SERIES

Trademark Type

Standard Characters

Goods

Class 33

whisky;

Application Number 2,000,011
Language of Application English

Filing Date 2019-12-06

APPLICANT AND AGENT DETAILS

Applicant

Mark Anthony Group Inc.
Unit 100 - 565 Great Northern Way
Vancouver
BRITISH COLUMBIA
V5T0H8

Agent

GOWLING WLG (CANADA) LLP
550 BURRARD STREET, SUITE 2300,
VANCOUVER, BRITISH COLUMBIA, V6C2B5

TRADEMARK DETAILS

ONE ELEVEN SERIES

Trademark Type

Standard Characters

Goods

Class 33

whisky;

Application Number 2,000,253
Language of Application English

Filing Date 2019-12-10

APPLICANT AND AGENT DETAILS

Applicant

Lost Craft Inc.
30 Grand Trunk Crescent
Toronto
ONTARIO
M5J3A4

Agent

DLA PIPER (CANADA) LLP
1 FIRST CANADIAN PLACE, SUITE 6000, P.
O. BOX 367, 100 KING STREET WEST,
TORONTO, ONTARIO, M5X1E2

TRADEMARK DETAILS

DEJADO

Trademark Type
Standard Characters

Goods

Class 33

Tequila.

Application Number 2,001,083
Language of Application English

Filing Date 2019-12-12

APPLICANT DETAILS

Applicant

Lee Yeates
5786 Carter Rd
Chilliwack
BRITISH COLUMBIA
V2R3K1

TRADEMARK DETAILS

Trademark Type

Design

Visual Representation



Colour Claim

Colour is claimed as a feature of the trademark. The text "DOG HOUSE" and the slogan "Free your mind, chase the adventure" are black in color and the tent on the top of the texts is in red color.

Goods

Class 22

awnings; tent canopies; tents; tents for camping; tents for mountaineering

Application Number 2,001,720
Language of Application English

Filing Date 2019-12-18

APPLICANT AND AGENT DETAILS

Applicant

Boosh Cosmetics Inc.
1703 Wrigley Road
Ayr
ONTARIO
N0B1E0

Agent

D. MICHAEL BEAN
(Michael Bean Trademark & Copyright Law), P.
O. Box 1737, STN GALT, Cambridge,
ONTARIO, N1R7G8

TRADEMARK DETAILS

BOOSH

Trademark Type

Standard Characters

Goods

Class 03

(1) Beauty care cosmetics; colognes, perfumes and cosmetics; lip balm; lip gloss; lipstick; make-up foundation; mascara.

Class 18

(2) Cosmetic bags sold empty.

Application Number 2,001,923
Language of Application English

Filing Date 2019-12-18

APPLICANT AND AGENT DETAILS

Applicant

Ag Growth International Inc.
198 Commerce Drive
Winnipeg
MANITOBA
R3P0Z6

Agent

MLT AIKINS LLP
2100 Livingston Place, 222-3rd Avenue SW,
Calgary, ALBERTA, T2P0B4

TRADEMARK DETAILS

STORMOR

Trademark Type
Standard Characters

Goods

Class 06

Grain bins;

Application Number 2,001,988
International Registration Number 1504915
Language of Application English

Filing Date 2019-08-12

APPLICANT AND AGENT DETAILS

Applicant

Jaguar Land Rover Limited
Abbey Road, Whitley
Coventry CV3 4LF
UNITED KINGDOM

Agent

DEETH WILLIAMS WALL LLP
150 YORK STREET, SUITE 400, TORONTO,
ONTARIO, M5H3S5

TRADEMARK DETAILS

LANDMARK

Trademark Type

Standard Characters

Goods

Class 12

Motor vehicles, namely, automobiles, trucks, vans, sport utility vehicles, and structural parts for all of the aforesaid goods; apparatus for locomotion by land, air and water, namely, cars, airplanes and boats, and structural parts for all of the aforesaid goods; off-road vehicles, namely, off-road utility vehicles, off-road trucks, and off-road terrain vehicles, and structural parts for all of the aforesaid goods; ATVs, and structural parts for all of the aforesaid goods; driverless motor vehicles, namely driverless cars, and structural parts for all of the aforesaid goods; autonomous motor vehicles, namely autonomous automobiles, trucks, vans, sport utility vehicles, and structural parts for all of the aforesaid goods; racing cars, and structural parts for all of the aforesaid goods; reconditioned classic vehicles, namely reconditioned classic automobiles, trucks, vans, sport utility vehicles, and structural parts for all of the aforesaid goods; vehicles sold in kit form, namely, automotive body kits comprising external structural parts of automobiles, and parts and fittings for all of the aforesaid goods; commercial vehicles, namely trucks and vans, and structural parts for all of the aforesaid goods; electric vehicles, namely, electrically powered motor vehicles, and structural parts for all of the aforesaid goods; hybrid vehicles, namely, hybrid cars, trucks, vans, sport utility vehicles, and structural parts for all of the aforesaid goods; military vehicles, namely, armoured cars, armoured trucks, tanks, military automobiles and sport utility vehicles, and structural parts for all of the aforesaid goods; vehicles for use by emergency services, search and rescue services, namely, police vehicles, namely, cars, trucks, vans, sport utility vehicles and ambulance, and structural parts for all of the aforesaid goods; powertrains for land vehicles, and parts and fittings for all of the aforesaid goods; engines for land vehicles, and parts and fittings for all of the aforesaid goods; motors for land vehicles, and parts and fittings for all of the aforesaid goods; engines for motorcycles, and parts and fittings for all of the aforesaid goods; motors for motorcycles, and parts and fittings for all of the aforesaid goods; engines for bicycles, and parts and fittings for all of the aforesaid goods; motors for bicycles, and parts and fittings for all of the aforesaid goods; engines for racing cars, and parts and fittings for all of the aforesaid goods; arm rests for vehicle seats, and parts and fittings for all of the aforesaid goods; luggage bags specially adapted for fitting in the boot of vehicles, and parts and fittings for all of the aforesaid goods; car

interior organizer bags, nets and trays specially adapted for fitting in vehicles, and parts and fittings for all of the aforesaid goods; head-rests for vehicle seats, and parts and fittings for all of the aforesaid goods; vehicle head rest covers, and parts and fittings for all of the aforesaid goods; wing mirror protective and vanity covers, and parts and fittings for all of the aforesaid goods; covers for vehicle steering wheels; fitted covers for vehicles; wheels for vehicles, and parts and fittings for all of the aforesaid goods; alloy wheels, and parts and fittings for all of the aforesaid goods; wheel trims, and parts and fittings for all of the aforesaid goods; wheel rims, and parts and fittings for all of the aforesaid goods; spare wheels, and parts and fittings for all of the aforesaid goods; hub caps for wheels, and parts and fittings for all of the aforesaid goods; hub centre caps, and parts and fittings for all of the aforesaid goods; wheel covers, and parts and fittings for all of the aforesaid goods; wheel sprockets, and parts and fittings for all of the aforesaid goods; spoilers for vehicles, and parts and fittings for all of the aforesaid goods; covers for vehicles; safety belts for vehicles, and parts and fittings for all of the aforesaid goods; safety harnesses for vehicles, and parts and fittings for all of the aforesaid goods; safety signals, audible, for vehicles, and parts and fittings for all of the aforesaid goods; anti-theft, security and safety devices and equipment for vehicles, and parts and fittings for all of the aforesaid goods; radiator grilles for vehicles, and parts and fittings for all of the aforesaid goods; trim panels for vehicle bodies, and parts and fittings for all of the aforesaid goods; doors for vehicles, and parts and fittings for all of the aforesaid goods; vehicle windows, and parts and fittings for all of the aforesaid goods; vehicle windshields, and parts and fittings for all of the aforesaid goods; window glass for vehicle windows and windshields, and parts and fittings for all of the aforesaid goods; roof windows for vehicles, and parts and fittings for all of the aforesaid goods; skylight windows for vehicles, and parts and fittings for all of the aforesaid goods; vehicle bumpers, and parts and fittings for all of the aforesaid goods; vehicle centre consoles sold as parts of vehicles and which incorporate electronic interfaces, and parts and fittings for all of the aforesaid goods; bicycles, and parts and fittings for all of the aforesaid goods; tricycles, and parts and fittings for all of the aforesaid goods; parts, fittings and accessories for bicycles; hoverboards, and parts and fittings for all of the aforesaid goods; scooters, and parts and fittings for all of the aforesaid goods; quadricycles, and parts and fittings for all of the aforesaid goods; motorised unicycles, and parts and fittings for all of the aforesaid goods; strollers and prams, and their parts and accessories; go-karts, and parts and fittings for all of the aforesaid goods; sun blinds, roof racks, luggage carriers and nets, cycle carriers, sail board carriers, ski carriers, and snow chains, all for vehicles, and parts and fittings for all of the aforesaid goods; drones, namely, camera drones, civilian drones, delivery drones, photography drones and military drones; unmanned aerial vehicles, and parts and fittings for all of the aforesaid goods; personal air vehicles, namely, personal aircraft, and structural parts for all of the aforesaid goods; hovercraft, and structural parts for all of the aforesaid goods; underwater vehicles, namely, underwater remotely operated vehicles for transport underwater and for underwater inspection, and structural parts for all of the aforesaid goods; jet vehicles for water sports, and structural parts for all of the aforesaid goods; remote control vehicles, not toys, and parts and fittings for all of the aforesaid goods.

Application Number 2,002,043
International Registration Number 1504164
Language of Application English

Filing Date 2019-09-24

APPLICANT AND AGENT DETAILS

Applicant

DIUSA SA
2 ap, Vasil Aprilov Str. 11
BG-1000 SOFIA
BULGARIA

Agent

MACRAE & CO.
326 Somerset Street West, Ottawa, ONTARIO,
K2P0J9

TRADEMARK DETAILS

Trademark Type

Design

Visual Representation



Goods

Class 05

(1) Mineral food supplements; medicated additives for animal foods; nutritional supplements for livestock feed; vitamin and mineral supplements for pets; pharmaceutical and medical complementary feed for animal foods; protein supplements for animals; veterinary vaccines; vaccines for cattle; disinfectants for veterinary use; feed supplements for veterinary use; fodder supplements for veterinary purposes; vitamins for animals; antiparasitic collars for animals; powders for killing fleas on animals; vitamin supplements for animals; insecticidal animal shampoos; animal washes [insecticides]; deodorizers for litter trays; antiparasitic preparations for pets; vitamins for pets.

Class 31

(2) Flowers; fresh fruits and vegetables; fresh fruits, nuts, vegetables and herbs; seeds for planting; pulses [foodstuffs for animals]; horticultural mulches; unseasoned timber; algarovilla for animal consumption; bran mash for animal consumption; malt; pet food; beverages for pets; woodshavings for use as animal bedding; formula animal feed; bird food; synthetic animal feed; food for aquarium fish; feeding preparations for bees; mixed animal feed; animal feed preparations; preserved crops for animal feeds; animal foodstuffs in the form of nuts; stall food for animals; residues from malt treatment for use as an animal feed; rabbit food; food for rodents; mushrooms, fresh, for food; food for wild birds; foods containing liver for feeding cats; foods containing liver for feeding dogs; aloe vera, fresh, for food; foods flavoured with liver for feeding dogs; foods flavoured with chicken for feeding cats; foods flavoured with chicken for feeding dogs; foods flavoured with liver for feeding cats; edible chews for animals; distillery waste for animal consumption; foods in the form of rings for feeding to cats; oat-based food for animals; foods

flavoured with beef for feeding dogs; foods flavoured with beef for feeding cats; foods in the form of rings for feeding to dogs; animal foodstuffs containing air-cured hay; canned foodstuffs consisting of meat for young animals; cereals preparations being food for animals; meal for consumption by animals; litter for animals; malt for animals; biscuits for animals; meal for animals; strengthening animal forage; animal fattening preparations.

Application Number 2,002,105
International Registration Number 1504677
Language of Application English

Filing Date 2019-10-11

APPLICANT AND AGENT DETAILS

Applicant

Refractory Intellectual Property GmbH & Co.
KG
Wienerbergstr. 11
A-1100 Wien
AUSTRIA

Agent

KIRBY EADES GALE BAKER
100 Murray Street, Suite 500, Ottawa,
ONTARIO, K1N0A1

TRADEMARK DETAILS

S-PORT

Trademark Type

Standard Characters

Goods

Class 19

refractory building materials, not of metal, namely refractory bricks, refractory shapes, refractory ceramic workpieces, refractory submerged entry nozzles, refractory furnace linings, refractory mixes, namely, refractory ramming mixes, refractory gunning mixes, refractory spraying mixes, refractory concrete, refractory ceramic masses and refractory mortars

Claims

Priority Filing Date: May 22, 2019, Country or Office: EUIPO (EU), Application No: 018071173 in association with the same kind of goods

Application Number 2,002,234
International Registration Number 1504874
Language of Application English

Filing Date 2019-10-31

APPLICANT AND AGENT DETAILS

Applicant

Nils Uwe Karstensen
Knakkegaardsvej 29, Skyum
DK-7752 Snedsted
DENMARK

Agent

GOWLING WLG (CANADA) LLP
1 MAIN STREET WEST, HAMILTON,
ONTARIO, L8P4Z5

TRADEMARK DETAILS

Trademark Type

Design

Visual Representation

ecoBETA

Goods

Class 09

(1) Water meters.

Class 11

(2) Apparatus for water supply namely water distribution installations in the nature of water mixing appliances, water control valves for water cisterns, water faucet spouts, water softening units, tap water faucets, washers for water faucets and, regulating and safety accessories for water mixing appliances, water control valves for water cisterns, water faucet spouts, water softening units, tap water faucets, washers for water faucets.

Application Number 2,002,312
International Registration Number 1504751
Language of Application English

Filing Date 2019-11-12

APPLICANT AND AGENT DETAILS

Applicant

Rahr Corporation
800 West First Ave.
Shakopee MN 55379
UNITED STATES OF AMERICA

Agent

GOWLING WLG (CANADA) LLP
SUITE 1600, 1 FIRST CANADIAN PLACE, 100
KING STREET WEST, TORONTO, ONTARIO,
M5X1G5

TRADEMARK DETAILS

Trademark Type

Design

Visual Representation



Trademark Description

The mark consists of the fletching end of an arrow in white inside a red circle above the words GAMBRINUS MALTING in black.

Colour Claim

Colour is claimed as a feature of the trademark. The color(s) red, white and black is/are claimed as a feature of the mark. The mark consists of the fletching end of an arrow in white inside a red circle above the words GAMBRINUS MALTING in black.

Goods

Class 31

Malt for brewing and distilling.

Claims

Priority Filing Date: November 04, 2019, Country or Office: UNITED STATES OF AMERICA, Application No: 88678543 in association with the same kind of goods

Application Number 2,002,501
Language of Application English

Filing Date 2019-12-19

APPLICANT AND AGENT DETAILS

Applicant

Rheem Manufacturing Company
500 Northpark Town Center
1100 Abernathy Road N.E.
Suite 1700
Atlanta, GA 30328
UNITED STATES OF AMERICA

Agent

STIKEMAN ELLIOTT LLP
SUITE 1600, 50 O'CONNOR STREET,
OTTAWA, ONTARIO, K1P6L2

TRADEMARK DETAILS

RHEEM

Trademark Type

Standard Characters

Goods

Class 11

Water treatment equipment, namely water filtration units and water filters; water softening units

Claims

Priority Filing Date: November 20, 2019, Country or Office: UNITED STATES OF AMERICA,
Application No: 88700006 in association with the same kind of goods

Application Number 2,002,502
Language of Application English

Filing Date 2019-12-19

APPLICANT AND AGENT DETAILS

Applicant

Rheem Manufacturing Company
500 Northpark Town Center
1100 Abernathy Road N.E.
Suite 1700
Atlanta, GA 30328
UNITED STATES OF AMERICA

Agent

STIKEMAN ELLIOTT LLP
SUITE 1600, 50 O'CONNOR STREET,
OTTAWA, ONTARIO, K1P6L2

TRADEMARK DETAILS

Trademark Type

Design

Visual Representation



Goods

Class 11

Water treatment equipment, namely water filtration units and water filters; water softening units

Claims

Priority Filing Date: November 20, 2019, Country or Office: UNITED STATES OF AMERICA,
Application No: 88700010 in association with the same kind of goods

Application Number 2,002,525
Language of Application English

Filing Date 2019-12-19

APPLICANT AND AGENT DETAILS

Applicant

Element Eight, Inc.
321 Kirkvalley Crescent
Aurora
ONTARIO
L4G7S1

Agent

GOWLING WLG (CANADA) LLP
SUITE 1600, 1 FIRST CANADIAN PLACE, 100
KING STREET WEST, TORONTO, ONTARIO,
M5X1G5

TRADEMARK DETAILS

Trademark Type

Design

Visual Representation



Goods

Class 18

(1) All-purpose sports bags; backpacks.

Class 25

(2) Athletic clothing; casual clothing; hats; hockey jerseys; hoodies; jackets; knit hats; pants; shirts; shorts; socks; sweaters; t-shirts; warm-up suits.

Services

Class 41

Fitness training; physical education; sports instruction in the field of hockey.

Application Number 2,003,380
International Registration Number 1371978
Language of Application English

Filing Date 2019-10-09

APPLICANT AND AGENT DETAILS

Applicant

«KONTI-RUS» JOINT STOCK COMPANY
ul. Zolotaia, 13
RU-305000 Kursk
RUSSIAN FEDERATION

Agent

CASSELS BROCK & BLACKWELL LLP
SCOTIA PLAZA, SUITE 2100, 40 KING
STREET WEST, TORONTO, ONTARIO,
M5H3C2

TRADEMARK DETAILS

Trademark Type

Design

Visual Representation



Trademark Description

The mark consists of the stylized word "Konti" with five images in the shapes of petals forming an arch above the letter "n"; around the verbal and pictorial elements, there are curved figures of irregular shape, forming a stylized frame.

Goods

Class 30

Buns; bread rolls; waffles; malt biscuits; fruit jellies [confectionery]; candy decorations for cakes; confectionery, namely, sugar confectionery, chocolate confectionery, gummy confectionery, coconut confectionery, cookie confectionery, and caramel confectionery; confectionery for decorating Christmas trees; cakes; pastries; peanut confectionery; almond confectionery; caramels [candy]; sweetmeats [candy]; liquorice [confectionery]; peppermint sweets; crackers; candy; macaroons [pastry]; marzipan; dessert mousses [confectionery]; chocolate-coated nuts; stick liquorice [confectionery]; candy pastilles; cookies; biscuits; petit-beurre biscuits; pies; fondants [confectionery]; pralines; gingerbread; petits fours [cakes]; spring rolls; sugar confectionery; chocolate-based spreads; chocolate spreads containing nuts; rusks; tarts; pastry dough; almond paste; cake dough; chocolate decorations for cakes; halvah; chocolate

Application Number 2,003,570
International Registration Number 1505382
Language of Application English

Filing Date 2019-11-18

APPLICANT AND AGENT DETAILS

Applicant

MOOSE CREATIVE MANAGEMENT PTY LTD
29 Grange Rd
Cheltenham VIC 3192
AUSTRALIA

Agent

ROBIC
630, boul. René-Lévesque Ouest, 20e étage,
Montréal, QUEBEC, H3B1S6

TRADEMARK DETAILS

JELLI REZ

Trademark Type

Standard Characters

Goods

Class 14

(1) Beads for making jewellery; jewellery cases, namely, caskets or boxes; jewellery chain; jewellery coated with precious metal alloys; jewellery coated with precious metals; jewellery made of plastics; jewellery made of precious stones; jewellery made of semi-precious materials; necklaces, namely, jewellery; rings, namely, jewellery; wrist watch bands, charity bracelets, jewellery; bracelets, namely, jewellery; watches; Clocks; watches; sundials; Chronometers; Stop watches; clocks; semi-precious stones; key rings with fobs or trinkets attached; charms for jewellery; jewellery made of precious metals; precious stones; costume jewellery; craft kits for jewellery construction; decorative articles, namely, trinkets rings, key chains with trinkets and jewellery for personal use; imitation jewellery; imitation jewellery ornamental brooches; jewellery; Jewellery boxes; jewellery brooches; jewellery cases; jewellery charms.

Class 16

(2) Adhesive stickers; stationery, namely, writing stationery; craft kits for painting and making posters; craft kits for papier mâché model construction; craft paper; craft cardboard; Paper and paper products in the nature of craft items, namely arts and crafts paint kits and children's arts and crafts paper kits; paper crafts materials, namely paper and colour pencils; Printed matter, namely trading card; trading cards, other than for games; stickers, namely, decalcomanias; Printed board game instruction manuals; rule books for playing games; Printed rules of play for games; children's painting sets; children's paint-boxes; Artists' brushes; artists' moulds; artists' palettes and artists' brushes; Modelling clay; modelling paste; plastics for modelling; Drawing pads; drawing paper; drawing pens; drawing pencils; Writing brushes; writing chalk; writing instruments; writing paper; modelling clay; Stationery, namely, stickers; Artists' materials, namely, moulds for modelling clays; art paper; adhesive backed films for use as decalcomanias; adhesive decalcomanias; booklets relating to games; printing blocks; art materials, namely, paint boxes for use in schools; Stationery for use as decorative trim, namely, adhesive backed films; adhesive backed films for stationery purposes; Stationery, namely, erasers; gums, namely, adhesives for stationery or household purposes; pastes for stationery or household purposes; Patterned writing stationery.

Class 26

(3) Decorative claw clips for the hair; hair accessories; decorative bows for the hair; synthetic hair.

Class 28

(4) Toys and playthings, namely, action figures; Plaything, namely, electronic action toys, electronic learning toys; figurines being toys; Playthings, namely, inflatable toys; plush toys; tactile educational toys; toy figures; toy models; toy vehicles; Toys, namely, action figure toys and collectable toy figures; board games; action figures toys; card games; electronic games, other than software for the teaching of children; Hand held electronic games incorporating their own visual display facilities ;games namely, arcade games, action target games, board games and card games; Electronic game consoles adapted for use with an external display screen and monitor; Electronic game consoles adapted for use with dot matrix liquid crystal displays; hand held electronic games; Tactile educational games for children; playing cards; dolls; Children's multiple activity toys; Electronic learning toys; playthings, namely, action figure toys and collectable toy figures; trading cards, namely, card games; construction toys; Craft toys sold complete, namely, toy model kits for constructing toy model buildings, vehicles, action figures and pretend food; craft toys sold in kit form, namely toy model kits for constructing toy model buildings, vehicles, action figures and pretend food; educational toys; Electronic action toys; Electronic action toys incorporating a talking mechanism.

Claims

Priority Filing Date: November 15, 2019, Country or Office: AUSTRALIA, Application No: 2050105 in association with the same kind of goods

Application Number 2,003,690
Language of Application English

Filing Date 2019-12-27

APPLICANT DETAILS

Applicant

1114098 B.C. LTD.
6251 No. 6 Road
Richmond
BRITISH COLUMBIA
V6W1C7

TRADEMARK DETAILS

NARUTO RAMEN

Trademark Type

Standard Characters

Disclaimer

The right to the exclusive use of the word NARUTO or RAMEN is disclaimed apart from the trademark.

Services

Class 43

bar and restaurant services; business catering services; cafe-restaurants; carry-out restaurant services; carry-out restaurants; catering services for hotels; fast food and non-stop restaurant services; fast-food restaurants; hotel catering services; hotel, restaurant and catering services; Japanese restaurant services; mobile cafe services for providing food and drink; mobile catering services; mobile restaurant services; providing information about restaurant services; providing restaurant services; restaurant services; restaurants; restaurants featuring home delivery; self service restaurants; self-service restaurant services; self-service restaurants; Spanish restaurant services; take-away restaurant services; take-out restaurant services; tourist restaurant services; udon and soba restaurant services

Application Number 2,003,734
Language of Application English

Filing Date 2019-12-30

APPLICANT AND AGENT DETAILS

Applicant

IGT
9295 Prototype Drive
Reno, NV 89521
UNITED STATES OF AMERICA

Agent

COLLEEN CAISSIE-DUPUIS
(c/o IGT Canada Solutions ULC), 328 Urquhart
Avenue, Moncton, NEW BRUNSWICK,
E1H2R6

TRADEMARK DETAILS

CAIFU ZHI WU

Trademark Type

Standard Characters

Foreign Character Translation

As provided by th applicant, the translation of the foreign words is: Dance of Wealth

Goods

Class 28

Gaming machines, namely, devices which accept a wager; Reconfigurable casino and lottery gaming equipment, namely, gaming machines; Lottery tickets; lottery cards; scratch cards for playing lottery games

Application Number 2,003,735
Language of Application English

Filing Date 2019-12-30

APPLICANT AND AGENT DETAILS

Applicant

IGT
9295 Prototype Drive
Reno, NV 89521
UNITED STATES OF AMERICA

Agent

COLLEEN CAISSIE-DUPUIS
(c/o IGT Canada Solutions ULC), 328 Urquhart
Avenue, Moncton, NEW BRUNSWICK,
E1H2R6

TRADEMARK DETAILS

FORTUNES FULFILLED

Trademark Type

Standard Characters

Goods

Class 28

- (1) Gaming machines, namely, devices which accept a wager; Reconfigurable casino and lottery gaming equipment, namely, gaming machines
(2) Lottery tickets; lottery cards; scratch cards for playing lottery games

Claims

Priority Filing Date: December 12, 2019, Country or Office: UNITED STATES OF AMERICA,
Application No: 88724333 in association with the same kind of goods (1)

Application Number 2,003,736
Language of Application English

Filing Date 2019-12-30

APPLICANT AND AGENT DETAILS

Applicant

IGT
9295 Prototype Drive
Reno, NV 89521
UNITED STATES OF AMERICA

Agent

COLLEEN CAISSIE-DUPUIS
(c/o IGT Canada Solutions ULC), 328 Urquhart
Avenue, Moncton, NEW BRUNSWICK,
E1H2R6

TRADEMARK DETAILS

SAMURAI 888

Trademark Type

Standard Characters

Goods

Class 28

(1) Gaming machines, namely, devices which accept a wager; Reconfigurable casino and lottery gaming equipment, namely, gaming machines

(2) Lottery tickets; lottery cards; scratch cards for playing lottery games

Claims

Priority Filing Date: December 12, 2019, Country or Office: UNITED STATES OF AMERICA,
Application No: 88724337 in association with the same kind of goods (1)

Application Number 2,003,853
Language of Application English

Filing Date 2019-12-30

APPLICANT DETAILS

Applicant

Realty Host Marketing INC
615-800 West Pender St
Vancouver
BRITISH COLUMBIA
V6C2V6

TRADEMARK DETAILS

Trademark Type

Design

Visual Representation



Services

Class 42

design, creation, hosting, maintenance of websites for others

Application Number 2,004,001
International Registration Number 1507672A
Language of Application English

Filing Date 2019-07-10

APPLICANT AND AGENT DETAILS

Applicant

Aetna Inc.
151 Farmington Avenue
Hartford CT 06156
UNITED STATES OF AMERICA

Agent

CPST INTELLECTUAL PROPERTY INC.
130 Queens Quay East, East Tower, Suite
809, Toronto, ONTARIO, M5A0P6

TRADEMARK DETAILS

Trademark Type

Design

Visual Representation



Trademark Description

The mark consists of a solid heart shape in violet color appearing before the word "AETNA" in violet color.

Colour Claim

Colour is claimed as a feature of the trademark. The color(s) violet is/are claimed as a feature of the mark. The mark consists of a solid heart shape in violet color appearing before the word "AETNA" in violet color

Goods

Class 09

Downloadable computer software for providing health, wellness, healthcare and medical information, namely health plan and health insurance information, health and fitness monitor and sensor data, and health predictive analytics, and providing access to health coaching services and healthcare in the nature of telemedicine services, scheduling medical appointments, providing health care incentives and rewards, and enabling communication with medical service providers

Services

Class 35

(1) Health care cost review and cost containment services; health care utilization management and review services for health care plans; medical cost management; administration of medical, dental, pharmacy, vision and behavioral health insurance services; administration of medicare benefit plans

Class 36

(2) Underwriting of medical, dental, pharmacy, vision and behavioral health insurance services; providing insurance information via an interactive website regarding health care coverage,

benefits, and claims; providing financial and insurance information via an interactive website regarding health fund transactions and estimated health care costs

Class 42

(3) Providing information via an interactive website featuring technology in the field of health, namely information regarding health plan and health insurance information, health and fitness monitor and sensor data, and health predictive analytics, and providing access to health coaching services and healthcare in the nature of telemedicine services, scheduling medical appointments, providing health care incentives and rewards, and enabling communication with medical service providers, and for connecting doctors with medical patients and providing medical information to doctors

Class 44

(4) Providing wellness and disease management programs namely programs in the fields of fitness, nutrition and stress management; behavioral health counseling services, namely programs in the field of behavioral change to promote wellness; mental health care counseling services; personal health assessments, namely personal assessments of health risk, fitness, nutrition and lifestyle; providing smoking cessation and weight loss program services; providing medical information, namely information regarding administering medications and medication management counseling services; managed health care services, namely health and wellness counseling services, namely nutrition counselling, psychological counseling, counselling relating to occupational therapy and medical counselling relating to stress; disease care management services, namely nurse care management outreach services, nursing services, nursing care, home nursing aid services, providing information and counselling in the field of behavioral modification and stress management, pharmacist advisory services, holistic treatment services for physical and emotional wellbeing, and acute, episodic care and hospital admissions prevention services, family nurse services for acute and chronic care management; medical care services, namely medical clinic services, home health care services, managed health care services namely, the electronic processing of health care information, mental health screening services, mental health services; nursing services; medical care services, namely providing personalized and customized health risk assessments, fitness assessments and nutritional assessments, providing home health care services, disease management, namely disease care management services, namely nurse care management outreach services, nursing services, nursing care, home nursing aid services, providing information and counselling in the field of behavioral modification and stress management, pharmacist advisory services, holistic treatment services for physical and emotional wellbeing, and acute, episodic care and hospital admissions prevention services, family nurse services for acute and chronic care management, and medical treatment clinic services and wellness plans and programs in the fields of fitness, nutrition and stress management; medical care services, namely providing personalized and customized advice and recommendations on home health care services, providing assistance in transitioning patients from hospital to home, namely, home health nursing services, and evaluating and monitoring a patient's medical condition; providing medical information, namely information on healthcare, namely medical clinic services, health and wellness programs in the fields of fitness, nutrition, stress management, mental health and occupational therapy, medications, and medical symptoms, conditions, procedures, and medical treatment services; providing on-line health care and health coaching services, namely providing online medical clinic services and counselling in the fields of fitness, nutrition, stress management, mental health and occupational therapy; providing information via an interactive website featuring health care providers, health care facilities, and preferred drug lists; providing information via an interactive website featuring health care providers, health care facilities, and preferred drug lists; providing personalized information via an interactive website to

health plan participants about health care services, namely health care providers, health care facilities, and preferred drug lists

Claims

Priority Filing Date: January 10, 2019, Country or Office: UNITED STATES OF AMERICA,
Application No: 88256787 in association with the same kind of goods and in association with the same kind of services

Application Number 2,004,037
International Registration Number 1507621
Language of Application French

Filing Date 2019-09-17

APPLICANT AND AGENT DETAILS

Applicant

Madame Marion TOUFET
6 impasse Franchemont
F-75011 Paris
FRANCE

Agent

BCF S.E.N.C.R.L./BCF LLP
1100, boul. René-Lévesque Ouest, 25e Étage,
Montréal, QUÉBEC, H3B5C9

TRADEMARK DETAILS

AQTE²

Trademark Type

Standard Characters

Goods

Class 18

(1) Leather and imitations of leather; animal skins, hides; trunks and suitcases; umbrellas, parasols and walking sticks; whips and saddlery; attaché cases; small clutch purses, key pouches, makeup bags, leather pouches, identification card cases; leather hat boxes; school bags; card holders; key cases; travel chests; vanity cases; wallets; coin purses; billfolds; portfolios; backpacks; handbags; shopping bags; wheeled bags; climbing bags; bags for campers; beach bags; sports bags; travel bags; school bags; student bags; leather briefcases; travel kits (leatherwork).

Class 25

(2) Clothing, namely T-shirts, pants, dresses, sweaters, skirts, athletic wear, business wear, exercise wear, outdoor winter wear, sleepwear; athletic shoes, training shoes, outdoor winter shoes, running shoes, leisure shoes, wedding shoes, beach shoes, evening shoes, dress shoes, tennis shoes, sports shoes, leather shoes, women's shoes, winter boots, rain boots, boots, ankle boots, sandals, loafers, casual shoes, outdoor winter shoes; headgear, namely hats, caps; belts; socks; gloves; wraps; ties; scarves; toe caps; shoe soles; shoe uppers; boot uppers.

Services

Class 35

Retail, wholesale and semi-wholesale, including online, of the following goods: leather and imitations of leather, animal skins, hides, trunks and suitcases, umbrellas, parasols and walking sticks, whips and saddlery, leatherwork items, namely wallets, billfolds, card holders, bags, namely small clutch purses, key pouches, makeup bags, leather pouches, pouches for identification cards, briefcases (leatherwork), namely briefcases for students, leather briefcases, attaché cases, pouches, leather hat boxes, satchels, card holders, key cases, travel chests, vanity cases, wallets, coin purses, billfolds, portfolios, backpacks, handbags, shopping bags, wheeled bags, climbing bags, bags for campers, beach bags, sports bags, travel bags, school bags, student bags, leather briefcases; travel kits (leatherwork), clothing, namely T-shirts, pants, dresses, sweaters, skirts, athletic wear, business clothing, exercise wear, outdoor winter clothing, sleepwear, athletic shoes, training shoes, outdoor winter shoes, running shoes, leisure shoes, wedding shoes, beach shoes,

evening shoes, dress shoes, tennis shoes, sports shoes, leather shoes, women's shoes, winter boots, rain boots, boots, ankle boots, sandals, loafers, casual shoes, everyday shoes, outdoor winter shoes, headgear, namely hats, caps, belts (apparel), socks, gloves (apparel), wraps (clothing), ties, scarves, toe caps, shoe soles, shoe uppers, boot uppers; technical, commercial and marketing assistance in the setting up and operation of franchises and shops selling products made of leather and imitation leather; provision of a searchable advertising guide on the Internet featuring the goods of other online vendors; business information and advice for consumers, namely price comparison services; publishing of advertising copy; dissemination of advertisements for others; rental of advertising space; publishing of advertising copy and advertising services for the goods and services of others in periodicals, in brochures, in newspapers and online on a computer network.

Claims

Priority Filing Date: July 11, 2019, Country or Office: FRANCE, Application No: 4566863 in association with the same kind of goods and in association with the same kind of services

Application Number 2,004,091
International Registration Number 1506475
Language of Application English

Filing Date 2019-10-16

APPLICANT DETAILS

Applicant

Shandong Mingsheng Chemical Engineering
Co.,Ltd
Chajiu industrial park,
Mingshui, Zhangqiu City,
Jinan City
Shandong Province
CHINA

TRADEMARK DETAILS

Trademark Type

Design

Visual Representation

MiRShine

Colour Claim

Colour is claimed as a feature of the trademark. The colors black, orange, and yellow are claimed as a feature of the mark. The mark consists of the stylized wording "MIRSHINE" with the letters "MIR" and "HINE" in black and the letter "S" in the colors orange and yellow.

Services

Class 42

Scientific and technological research in the field of natural disasters; mechanical research in the field of motorsports; consultancy in the field of energy-saving; research in the field of environmental protection; analysis of stream water quality; chemical laboratories; energy auditing; technical writing; architectural design.

Application Number 2,004,472
Language of Application English

Filing Date 2020-01-02

APPLICANT AND AGENT DETAILS

Applicant

Alejandro Fernández Tinto Pesquera, S.L.
C/ Real, 2, 47315, Pesquera de Duero
Valladolid,
SPAIN

Agent

MOFFAT & CO.
P.O. Box 2088, Station D, Ottawa, ONTARIO,
K1P5W3

TRADEMARK DETAILS

ALEJAIREN

Trademark Type

Standard Characters

Goods

Class 33

Wine.

Application Number 2,004,599
Language of Application English

Filing Date 2020-01-03

APPLICANT AND AGENT DETAILS

Applicant

TripleOne Inc.
8777 Route Transcanadienne, Suite 111
Saint-Laurent, Quebec
QUEBEC
H4S1Z6

Agent

MOFFAT & CO.
P.O. Box 2088, Station D, Ottawa, ONTARIO,
K1P5W3

TRADEMARK DETAILS

Trademark Type

Design

Visual Representation



Services

Class 41

(1) Entertainment services, namely, provision of children's play areas at restaurants, provision of arcade games, amusement arcades and amusement arcade rides; providing video and coin operated games

Class 43

(2) Restaurant services

Class 44

(3) Hair salon services for children

Application Number 2,004,890
Language of Application English

Filing Date 2020-01-07

APPLICANT DETAILS

Applicant

Banglez Jewelry Inc.
2387 Trafalgar Rd.
Oakville
ONTARIO
L6H6K7

TRADEMARK DETAILS

Trademark Type

Design

Visual Representation



Colour Claim

Colour is claimed as a feature of the trademark. The word Banglez is in green (pantone 375c). The words "est. 2006" are in grey. Pantone is a registered trademark.

Services

Class 35

retail services for jewellery

Application Number 2,005,719
Language of Application English

Filing Date 2020-01-10

APPLICANT AND AGENT DETAILS

Applicant

Colgate-Palmolive Canada Inc.
Two Morneau Sobeco Center
6th Floor, 895 Don Mills Road
Toronto
ONTARIO
M3C1W3

Agent

SMART & BIGGAR LLP
1100-150 York street, TORONTO, ONTARIO,
M5H3S5

TRADEMARK DETAILS

PLAQLESS PRO

Trademark Type

Standard Characters

Goods

Class 09

(1) Downloadable computer software and mobile application software for use in tracking, processing, and displaying oral hygiene data and educating consumers in the field of oral hygiene

Class 21

(2) Toothbrushes

Application Number 2,006,296
Language of Application English

Filing Date 2020-01-15

APPLICANT AND AGENT DETAILS

Applicant

JANG YUL YEOM
14F, GANGDONG HERRSCHERWC TOWER,
1089, CHEONHO-DAERO, GANGDONG-GU
SEOUL, 05339,
REPUBLIC OF KOREA

Agent

DJB
500 Boulevard Gouin E, Suite 302, Montréal,
QUEBEC, H3L3R9

TRADEMARK DETAILS

SICHIMI

Trademark Type

Standard Characters

Goods

Class 25

Underwear; panties; brassières; lingerie; camisoles; body suits; socks; casual shoes; nylon stockings; leg warmers; trousers; skirts; t-shirts; women's shirts; night shirts; gloves with conductive fingertips; beach clothes; scarves; pajamas.

Application Number 2,006,330
International Registration Number 1509081A
Language of Application English

Filing Date 2019-07-10

APPLICANT AND AGENT DETAILS

Applicant

Aetna Inc.
151 Farmington Avenue
Hartford CT 06156
UNITED STATES OF AMERICA

Agent

CPST INTELLECTUAL PROPERTY INC.
130 Queens Quay East, East Tower, Suite
809, Toronto, ONTARIO, M5A0P6

TRADEMARK DETAILS

Trademark Type

Design

Visual Representation



Trademark Description

The mark consists of a solid heart shape appearing before the word "AETNA".

Goods

Class 09

Downloadable computer software for providing health, wellness, healthcare and medical information, namely health plan and health insurance information, health and fitness monitor and sensor data, and health predictive analytics, and providing access to health coaching services and healthcare in the nature of telemedicine services, scheduling medical appointments, providing health care incentives and rewards, and enabling communication with medical service providers

Services

Class 35

(1) Health care cost review and cost containment services; health care utilization management and review services for health care plans; medical cost management; administration of medical, dental, pharmacy, vision and behavioral health insurance services; administration of medicare benefit plans

Class 36

(2) Underwriting of medical, dental, pharmacy, vision and behavioral health insurance services; providing insurance information via an interactive website regarding health care coverage, benefits, and claims; providing financial and insurance information via an interactive website regarding health fund transactions and estimated health care costs.

Class 42

(3) Providing information via an interactive website featuring technology in the field of health, namely information regarding health plan and health insurance information, health and fitness monitor and sensor data, and health predictive analytics, and providing access to health coaching

services and healthcare in the nature of telemedicine services, scheduling medical appointments, providing health care incentives and rewards, and enabling communication with medical service providers, and for connecting doctors with medical patients and providing medical information to doctors

Class 44

(4) Providing wellness and disease management programs namely programs in the fields of fitness, nutrition and stress management; behavioral health counseling services, namely programs in the field of behavioral change to promote wellness; mental health care counseling services; personal health assessments, namely personal assessments of health risk, fitness, nutrition and lifestyle; providing smoking cessation and weight loss program services; providing medical information, namely information regarding administering medications and medication management counseling services; managed health care services, namely health and wellness counseling services, namely nutrition counselling, psychological counseling, counselling relating to occupational therapy and medical counselling relating to stress; disease care management services, namely nurse care management outreach services, nursing services, nursing care, home nursing aid services, providing information and counselling in the field of behavioral modification and stress management, pharmacist advisory services, holistic treatment services for physical and emotional wellbeing, and acute, episodic care and hospital admissions prevention services, family nurse services for acute and chronic care management; medical care services, namely medical clinic services, home health care services, managed health care services namely, the electronic processing of health care information, mental health screening services, mental health services; nursing services; medical care services, namely providing personalized and customized health risk assessments, fitness assessments and nutritional assessments, providing home health care services, disease management, namely disease care management services, namely nurse care management outreach services, nursing services, nursing care, home nursing aid services, providing information and counselling in the field of behavioral modification and stress management, pharmacist advisory services, holistic treatment services for physical and emotional wellbeing, and acute, episodic care and hospital admissions prevention services, family nurse services for acute and chronic care management, and medical treatment clinic services and wellness plans and programs in the fields of fitness, nutrition and stress management; medical care services, namely providing personalized and customized advice and recommendations on home health care services, providing assistance in transitioning patients from hospital to home, namely, home health nursing services, and evaluating and monitoring a patient's medical condition; providing medical information, namely information on healthcare, namely medical clinic services, health and wellness programs in the fields of fitness, nutrition, stress management, mental health and occupational therapy, medications, and medical symptoms, conditions, procedures, and medical treatment services; providing on-line health care and health coaching services, namely providing online medical clinic services and counselling in the fields of fitness, nutrition, stress management, mental health and occupational therapy; providing information via an interactive website featuring health care providers, health care facilities, and preferred drug lists; providing information via an interactive website featuring health care providers, health care facilities, and preferred drug lists; providing personalized information via an interactive website to health plan participants about health care services, namely health care providers, health care facilities, and preferred drug lists

Claims

Priority Filing Date: January 10, 2019, Country or Office: UNITED STATES OF AMERICA, Application No: 88256454 in association with the same kind of goods and in association with the same kind of services

Application Number 2,006,600
Language of Application English

Filing Date 2020-01-16

APPLICANT AND AGENT DETAILS

Applicant

Mapleview Agri Ltd.
8610 Concession 12
Mapleton R.R. 1
Palmerston
ONTARIO
N0G2P0

Agent

D. MICHAEL BEAN
(Michael Bean Trademark & Copyright Law), P.
O. Box 1737, STN GALT, Cambridge,
ONTARIO, N1R7G8

TRADEMARK DETAILS

TRUVITAL

Trademark Type
Standard Characters

Goods

Class 05

(1) animal feed additives for use as nutritional supplements; vitamin supplements for animals;

Class 31

(2) animal feed;

Application Number 2,006,721
Language of Application English

Filing Date 2020-01-17

APPLICANT DETAILS

Applicant

Comeback Snacks Inc.
3206-19 Grand Trunk Cres
Toronto
ONTARIO
M5J3A3

TRADEMARK DETAILS

Comeback Snacks

Trademark Type

Standard Characters

Disclaimer

The right to the exclusive use of the word Snacks is disclaimed apart from the trademark.

Goods

Class 30

caramel popcorn; cereal-based snack food; corn chips; corn-based snack food; granola-based snack bars; granola-based snack food; kettle corn; popcorn; popping corn; rice-based snack food; snack crackers; tortilla chips; wheat-based snack food;

Application Number 2,007,467
Language of Application English

Filing Date 2020-01-22

APPLICANT AND AGENT DETAILS

Applicant

Instant Brands Inc.
11-300 Earl Grey Drive
Suite 383
Ottawa
ONTARIO
K2T1C1

Agent

BERESKIN & PARR LLP/S.E.N.C.R.L., S.R.L.
SCOTIA PLAZA, 40 KING STREET WEST,
40th FLOOR, TORONTO, ONTARIO, M5H3Y2

TRADEMARK DETAILS

EvenCrisp

Trademark Type

Standard Characters

Goods

Class 11

Electric pressure cooker, and parts and fittings therefor; electric cooking ovens for household purposes, and parts and fittings therefor; microwave ovens; toasters; toaster ovens; electric grills, and parts and fittings therefor; electric kettles; electric milk makers for crushing nuts, beans and grains to produce milk-like liquids; electric soya and nut milk makers; electric rice cookers, and parts and fittings therefor; constant temperature circulators, immersion circulators, and thermal circulators for small household appliances used for cooking, and parts and fittings therefor; electric appliances for making yogurt; bread making machines; electric roasters for cooking food for household purposes, and parts and fittings therefor; electric coffee brewers, electric coffee machines, electric coffee percolators, and parts and fittings therefor; deep fryers; air fryers, and parts and fittings therefor; electric food choppers; food dehydrators, and parts and fittings therefor; ice cream makers; bread makers; electric rice cookers; electric induction hobs; gas grills; electric popcorn makers; electric ranges, electric cooking stoves for household purposes, electric air fryers, bakers' ovens, and parts and fittings therefor, convection ovens, conventional ovens, gas cooking ovens for household purposes, hot air ovens, induction ovens, industrial cooking ovens, gas stoves for household purposes, kitchen stoves, and parts and fittings therefor; electric food warmers, and parts and fittings therefor; food steamers, electric, and parts and fittings therefor; electric multi-purpose cookers for household use, and parts and fittings therefor; steam cookers; electric and gas cookers with integrated grills; electric and gas cookers with incorporated eye level grills; hot plates for cooking; electric cooking pans; electric frying pans; electric egg boilers; electric egg steamers for household purposes; electric ramen noodle cookers; stands specially adapted for electric rice cookers, slow cookers, pressure cookers, and multi-purpose cookers; barbecue apparatus, namely, barbecues, barbecue grills, barbecue smoker cooking grates, and cooking grates adapted for barbecue grills; beverage cooling and ice dispensing machines; electric sous-vide cookers, and parts and fittings therefor; slow cookers, and parts and fittings therefor; electric waffle irons; combined air fryer and pressure cooker, and parts and fittings therefor; air fryer attachments for use with electric pressure cookers

Application Number 2,008,322
Language of Application English

Filing Date 2020-01-27

APPLICANT AND AGENT DETAILS

Applicant

MAG CANADA BEVERAGE LTD.
Unit 100 - 565 Great Northern Way
Vancouver
BRITISH COLUMBIA
V5T0H8

Agent

GOWLING WLG (CANADA) LLP
550 BARRARD STREET, SUITE 2300,
VANCOUVER, BRITISH COLUMBIA, V6C2B5

TRADEMARK DETAILS

WHITE CLAW HARD SELTZER MADE PURE

Trademark Type

Standard Characters

Goods

Class 32

(1) ale; beer; beer-based cocktails; flavoured beers; lager; porter; stout;

Class 33

(2) alcoholic cocktails; alcoholic cocktails in the form of chilled gelatins; alcoholic coolers; alcoholic fruit drinks; alcoholic lemonade; alcoholic malt-based coolers; alcoholic punches; alcoholic seltzer; hard seltzer; vodka seltzer;

Application Number 2,008,571
Language of Application French

Filing Date 2020-01-29

APPLICANT AND AGENT DETAILS

Applicant

9375-3655 Québec inc.
1490 3E Av Du Parc-Industriel
Sainte-Marie
QUÉBEC
G6E3T9

Agent

TECHTONIK LEGAL INC.
370 rue Gilberte-Dubé, Montréal, QUÉBEC,
H4G3J7

TRADEMARK DETAILS

AMSTEL

Trademark Type

Standard Characters

Services

Class 35

(1) real estate sales management services; business intermediary services relating to the matching of potential private investors with entrepreneurs needing funding; business project management services for construction projects

Class 36

(2) acquisition of real estate for others; acquisition of real estate for others; property management consulting services; venture capital financing; project financing; financing of loans; management of apartments; building management; real estate management; real estate investment services; rental of real estate; arranging of leases and rental agreements for real estate; arranging of loans; arranging finance for construction projects; real estate investment; real estate consultation; real estate consultancy; credit and loan services; real estate management; securities lending; assessment and management of real estate

Class 37

(3) construction of residential and commercial properties; building construction services; building of shops; construction and renovation of buildings; house building and repair; real estate development; project management in the field of building construction; general building contractor services; supervision of building construction

Application Number 2,008,787
International Registration Number 1511385
Language of Application English

Filing Date 2019-11-01

APPLICANT AND AGENT DETAILS

Applicant

RSM Imagineering AS
Rosenholmveien 25
N-1414 TROLLÅSEN
NORWAY

Agent

MBM INTELLECTUAL PROPERTY LAW LLP
275 SLATER STREET, 14TH FLOOR,
OTTAWA, ONTARIO, K1P5H9

TRADEMARK DETAILS

Trademark Type

Design

Visual Representation



Goods

Class 07

High pressure pumps for well stimulation; pump systems for well stimulation comprising pumps for liquids under high pressure

Services

Class 37

Installation, repair and maintenance of pumps and pump systems comprising pumps.

Claims

Priority Filing Date: October 04, 2019, Country or Office: NORWAY, Application No: 201913211 in association with the same kind of goods and in association with the same kind of services

Application Number 2,009,087
Language of Application English

Filing Date 2020-01-30

APPLICANT AND AGENT DETAILS

Applicant

CSN Collision Centres Inc.
9-1155 North Service Rd W
Oakville
ONTARIO
L6M3E3

Agent

DAVID J. GRAY
Suite 1104, 4789 Yonge Street, Toronto,
ONTARIO, M2N0G3

TRADEMARK DETAILS

COLLISION SOLUTIONS NETWORK

Trademark Type

Standard Characters

Services

Class 35

(1) Auto body repair services, namely the operation of a call centre

Class 36

(2) Auto body repair services, namely insurance claims management and motor vehicle appraisal services

Class 37

(3) Auto body repair services, namely automotive refinishing

Class 39

(4) Auto body repair services, namely vehicle towing services and car rental services

Application Number 2,009,088
Language of Application English

Filing Date 2020-01-30

APPLICANT AND AGENT DETAILS

Applicant

CSN Collision Centres Inc.
9-1155 North Service Rd W
Oakville
ONTARIO
L6M3E3

Agent

DAVID J. GRAY
Suite 1104, 4789 Yonge Street, Toronto,
ONTARIO, M2N0G3

TRADEMARK DETAILS

CSN COLLISION

Trademark Type

Standard Characters

Services

Class 35

(1) Auto body repair services, namely the operation of a call centre

Class 36

(2) Auto body repair services, namely insurance claims management and motor vehicle appraisal services

Class 37

(3) Auto body repair services, namely automotive refinishing

Class 39

(4) Auto body repair services, namely vehicle towing services and car rental services

Application Number 2,009,089
Language of Application English

Filing Date 2020-01-30

APPLICANT AND AGENT DETAILS

Applicant

CSN Collision Centres Inc.
9-1155 North Service Rd W
Oakville
ONTARIO
L6M3E3

Agent

DAVID J. GRAY
Suite 1104, 4789 Yonge Street, Toronto,
ONTARIO, M2N0G3

TRADEMARK DETAILS

CSN COLLISION SOLUTIONS NETWORK

Trademark Type

Standard Characters

Services

Class 35

(1) Auto body repair services, namely the operation of a call centre

Class 36

(2) Auto body repair services, namely insurance claims management and motor vehicle appraisal services

Class 37

(3) Auto body repair services, namely automotive refinishing

Class 39

(4) Auto body repair services, namely vehicle towing services and car rental services

Application Number 2,009,090
Language of Application English

Filing Date 2020-01-30

APPLICANT AND AGENT DETAILS

Applicant

CSN Collision Centres Inc.
9-1155 North Service Rd W
Oakville
ONTARIO
L6M3E3

Agent

DAVID J. GRAY
Suite 1104, 4789 Yonge Street, Toronto,
ONTARIO, M2N0G3

TRADEMARK DETAILS

COLLISION SOLUTIONS

Trademark Type

Standard Characters

Services

Class 35

(1) Auto body repair services, namely the operation of a call centre

Class 36

(2) Auto body repair services, namely insurance claims management and motor vehicle appraisal services

Class 37

(3) Auto body repair services, namely automotive refinishing

Class 39

(4) Auto body repair services, namely vehicle towing services and car rental services

Application Number 2,009,102
Language of Application English

Filing Date 2020-01-30

APPLICANT AND AGENT DETAILS

Applicant

IGT
9295 Prototype Drive
Reno, NV 89521
UNITED STATES OF AMERICA

Agent

COLLEEN CAISSIE-DUPUIS
(c/o IGT Canada Solutions ULC), 328 Urquhart
Avenue, Moncton, NEW BRUNSWICK,
E1H2R6

TRADEMARK DETAILS

TRIPLE GOLDEN PANTHER

Trademark Type

Standard Characters

Goods

Class 28

(1) Gaming machines, namely, devices which accept a wager; Reconfigurable casino and lottery gaming equipment, namely, gaming machines

(2) Lottery tickets; lottery cards; scratch cards for playing lottery games

Claims

Priority Filing Date: January 13, 2020, Country or Office: UNITED STATES OF AMERICA,
Application No: 88756558 in association with the same kind of goods (1)

Application Number 2,009,211
Language of Application English

Filing Date 2020-01-30

APPLICANT AND AGENT DETAILS

Applicant

MAG CANADA BEVERAGE LTD.
Unit 100 - 565 Great Northern Way
Vancouver
BRITISH COLUMBIA
V5T0H8

Agent

ACCUPRO TRADEMARK SERVICES LLP
SUITE 702 - 401 WEST GEORGIA STREET,
VANCOUVER, BRITISH COLUMBIA, V6B5A1

TRADEMARK DETAILS

WHITE CLAW HARD SELTZER SURGE

Trademark Type

Standard Characters

Goods

Class 32

(1) ale; beer; beer-based cocktails; flavoured beers; lager; porter; stout;

Class 33

(2) alcoholic cocktails; alcoholic cocktails in the form of chilled gelatins; alcoholic coolers; alcoholic fruit drinks; alcoholic lemonade; alcoholic malt-based coolers; alcoholic punches; alcoholic seltzer; hard seltzer; vodka seltzer;

Application Number 2,009,920
Language of Application English

Filing Date 2020-02-05

APPLICANT AND AGENT DETAILS

Applicant

Instant Brands Inc.
11-300 Earl Grey Drive
Suite 383
Ottawa
ONTARIO
K2T1C1

Agent

BERESKIN & PARR LLP/S.E.N.C.R.L., S.R.L.
SCOTIA PLAZA, 40 KING STREET WEST,
40th FLOOR, TORONTO, ONTARIO, M5H3Y2

TRADEMARK DETAILS

INSTANT CRISP

Trademark Type

Standard Characters

Goods

Class 11

Air fryers, and parts and fittings therefor; electric tea kettles; toaster ovens; electric food steamers, and parts and fittings therefor; sous-vide immersion circulators, and parts and fittings therefor; electric cooktops; induction cooktops; electric coffee makers and brewers, electric espresso makers, and parts and fittings therefor; electric grills for household purposes; electric griddles; air cleaning units; hot plates; microwave ovens; electric pressure cookers, slow cookers, and parts and fittings therefor; humidifiers; dehumidifiers; ceiling fans, electric fans for household purposes; machines using heat and steam to pasteurize and sanitize dishes and kitchen utensils; constant temperature circulators, thermal circulators for small household appliances used for cooking, and parts and fittings therefor; electric cooking ovens for household purposes, and parts and fittings therefor; baking ovens for household purposes, and parts and fittings therefor; electric appliances for making yogurt; bread making machines; electric roasters for cooking food for household purposes, and parts and fittings therefor; deep fryers; food dehydrators, and parts and fittings therefor; ice cream makers; breadmakers; electric rice cookers, and parts and fittings therefor; electric induction hobs; gas grills; electric popcorn makers; drinking water dispensers; refrigerators; led light bulbs; bread toasters; beverage cooling and ice dispensing machines; tap-water purifying apparatus and machines; heaters for baths; freezers; gas purification machines; electric heaters for baby bottles; cooking stoves; electric autoclaves for cooking; electric cooking pots and pans; barbecues; gas burners; oven burners; electric ranges, electric cooking stoves for household purposes, electric air fryers, bakers' ovens, convection ovens, conventional ovens, gas cooking ovens for household purposes, hot air ovens, induction ovens, industrial cooking ovens, gas stoves for household purposes, kitchen stoves, and parts and fittings therefor; electric food warmers, and parts and fittings therefor; food steamers, electric, and parts and fittings therefor; electric multi-purpose cookers for household use, and parts and fittings therefor; steam cookers; electric and gas cookers with integrated grills; electric and gas cookers with incorporated eye level grills; hot plates for household purposes; electric cooking pans; electric frying pans; electric egg boilers; electric egg steamers for household purposes; electric ramen noodle cookers; stands specially adapted for electric rice cookers, slow cookers, pressure cookers, and multi-purpose

cookers; barbecue apparatus, namely, barbecue grills, barbecue smoker cooking grates, and cooking grates adapted for barbecue grills; beverage cooling and ice dispensing machines; electric sous-vide cookers; slow cookers; electric waffle irons

Application Number 2,010,193
International Registration Number 1513025
Language of Application English

Filing Date 2019-12-09

APPLICANT AND AGENT DETAILS

Applicant

Scania CV AB
SE-151 87 Södertälje
SWEDEN

Agent

ROBIC
630, boul. René-Lévesque Ouest, 20e étage,
Montréal, QUEBEC, H3B1S6

TRADEMARK DETAILS

Trademark Type

Design

Visual Representation



Colour Claim

Colour is claimed as a feature of the trademark. The words SCANIA ASSISTANCE and the logo on its left are blue on a white background.

Services

Class 37

(1) Vehicle repair services, including such services given along roads and at sites of accident; vehicle breakdown repair services; assistance in the installation, changing, replacement and repair of vehicle locks, starting of vehicles and tire change namely vehicle battery charging, retreading of tires; providing information relating to vehicle repair services; vehicle maintenance services, including anti-corrosive treatment; vehicle cleaning, motor cleaning; installation and repair of air conditioning apparatus; installation and repair of telecommunications equipment intended for vehicles namely installation and repair of computer hardware, vehicle upholstery and upholstery repair; retreading of tires; rental of bulldozers and excavators; rental of cranes and other construction equipment for construction and repair of buildings.

Class 39

(2) Transport namely bus transport, truck transport; towing and salvage; rescue operations (transport) namely emergency automobile towing; storage namely rental of storage containers, warehouse storage services; delivery of goods by truck; delivery of emergency goods namely delivery of goods by air, delivery of goods by mail order; vehicle rental, truck rental, coach rental, garage rental; transportation information namely providing road and traffic information; message delivery.

Claims

Priority Filing Date: July 02, 2019, Country or Office: EUIPO (EU), Application No: 018089787 in association with the same kind of services

Application Number 2,010,506
Language of Application English

Filing Date 2020-02-06

APPLICANT DETAILS

Applicant

Rêve Wellness Inc.
416 Napier St
Collingwood
ONTARIO
L9Y3T7

TRADEMARK DETAILS

Rêve Wellness

Trademark Type

Standard Characters

Goods

Class 03

(1) after shave lotions; after sun creams; after sun moisturisers; after-shave; after-shave balms; after-shave cologne; after-shave lotions; after-sun creams; after-sun creams and preparations; after-sun lotions; after-sun milks; after-sun moisturizers; aftershave; aftershave lotions; age spot reducing creams; anti-aging cream; anti-aging creams; anti-aging moisturizers; anti-perspirants and deodorants for personal use; anti-wrinkle creams; antiperspirants and deodorants for personal use; aromatherapy creams; aromatherapy lotions; aromatherapy oils; aromatic essential oils; aromatic oils for the bath; bar soap; bases for flower perfumes; bath additives; bath and shower gels; bath bombs; bath crystals; bath fizzies; bath herbs; bath oils; bath oils and bath salts; bath salts for cosmetic purposes; bath salts not for medical purposes; bath soaps in liquid, solid or gel form; bay rums; beauty balm creams; beauty care cosmetics; beauty creams; beauty creams for body care; beauty lotions; beauty masks; beauty milks; body and beauty care cosmetics; body care soap; body creams; body lotions; body milks; body moisturizers; body moisturizing milk; body oils; body scrub; body wash; bubble bath; bubble bath preparations; cologne; day cream; deodorants for body care; eaux de perfume; emulsions, gels and lotions for skin care; essential oils for aromatherapy; essential oils for cosmetic purposes; essential oils for the manufacture of perfumes; essential oils for use in aromatherapy; exfoliants for the skin; exfoliating scrubs for the body; eye cream; face and body creams; face and body lotions; face cream; facial scrubs; fragrances and perfumery; hand creams; lip balm; lip care preparations; liquid perfumes; lotions for cellulite reduction; magnesium bath flakes; massage oils; massage oils and lotions; moisturising skin lotions; moisturizing body lotions; natural perfumery; night creams; perfume oils; perfumes; perfumes in solid form; polishing creams; pomanders; scented bath salts; scented body creams; scented body lotions; scented body sprays; scented linen sprays; shower and bath gels; skin care creams; skin care lotions; skin creams; skin lotions; skin moisturisers; skin scrub; skin soap; skin toners; soaps for body care; solid shampoo bars; terpenes; toning lotion, for the face, body and hands

Class 05

(2) analgesic balms; anti-inflammatory salves; bath salts for medical purposes; botanicals for use in the treatment of dermatitis and skin pigmentation diseases; cannabidiol [CBD] oil for medical purposes; cannabidiol for medical purposes; epsom salt; epsom salts for medical purposes; gels for use as personal lubricants; herbal supplements for the treatment of inflammatory diseases, namely inflammatory bowel diseases and inflammatory connective tissue diseases; herbal supplements for the treatment of the musculoskeletal system, namely, connective tissue diseases, cartilage injuries; herbal supplements for use in dermatology, namely, dermatitis, eczema, psoriasis; massage gels for pain relief; medicated muscle soaks; medicinal cannabis; medicinal cannabis for the relief of nerve pain; medicinal cannabis for the treatment of muscle spasms caused by multiple sclerosis; medicinal marijuana; medicinal marijuana for the relief of nerve pain; medicinal marijuana for the treatment of muscle spasms caused by multiple sclerosis; mineral salts for baths; mineral salts for medical purposes; ointments for sunburn; orgasm creams; pain relief preparations; preparations for the relief of pain; preparations for the treatment of burns; tetrahydrocannabinol [THC] oil for medical purposes; THC oil for medical purposes; therapeutic medicated bath preparations; therapeutic preparations for the bath; topical analgesic creams; topical analgesics; vaginal lubricants

Application Number 2,010,553
Language of Application French

Filing Date 2020-02-07

APPLICANT AND AGENT DETAILS

Applicant

DECATHLON, Société européenne
4 BOULEVARD DE MONS
59650 VILLENEUVE D'ASCQ,
FRANCE

Agent

LAVERY, DE BILLY, LLP
1 Place Ville Marie, Suite 4000, Montréal,
QUÉBEC, H3B4M4

TRADEMARK DETAILS

KLIC&TIP

Trademark Type

Standard Characters

Goods

Class 18

Walking poles; hiking poles.

Claims

Priority Filing Date: August 29, 2019, Country or Office: EUIPO (EU), Application No: 18117557 in association with the same kind of goods

Application Number 2,010,671
Language of Application French

Filing Date 2020-02-07

APPLICANT DETAILS

Applicant

Gingras Moïse (1969) Inc.
6660 Rue Beaubien Est
Montréal
QUÉBEC
H1M3E3

TRADEMARK DETAILS

Trademark Type

Design

Visual Representation



Colour Claim

Colour is claimed as a feature of the trademark. The trademark is black on white.

Services

Class 36

Fire insurance; marine insurance; life insurance; insurance; life insurance; insurance premium rate computing; advice and information related to insurance; consulting related to insurance; life insurance brokerage; insurance brokerage; brokerage in relation to insurance; provision of insurance information.

Application Number 2,010,880
Language of Application English

Filing Date 2020-02-10

APPLICANT AND AGENT DETAILS

Applicant

Proven Winners North America LLC
45 North First Street, Suite B
P.O. Box 248
Campbell, CA 95008
UNITED STATES OF AMERICA

Agent

MOFFAT & CO.
P.O. Box 2088, Station D, Ottawa, ONTARIO,
K1P5W3

TRADEMARK DETAILS

DOUBLE DELIGHT

Trademark Type

Standard Characters

Goods

Class 31

living plants

Claims

Priority Filing Date: October 04, 2019, Country or Office: UNITED STATES OF AMERICA,
Application No: 88/642,167 in association with the same kind of goods

Application Number 2,010,994
Language of Application French

Filing Date 2020-02-11

APPLICANT AND AGENT DETAILS

Applicant

J.M. CLÉMENT LTÉE
5830 Boul Pierre-Bertrand
Québec
QUÉBEC
G2J1B7

Agent

ID MARQUE / TRADEMARK
226, boul. Sir-Wilfrid-Laurier, Beloeil,
QUÉBEC, J3G4G7

TRADEMARK DETAILS

Trademark Type

Design

Visual Representation



Goods

Class 25

Plastic baby bibs; Bermuda shorts; bathing caps; shower caps; swimming caps; nightcaps; knitted caps; boots; winter boots; rain boots; rubber boots; baby boots; ankle boots; boxer shorts; suspenders; neck warmers; camisoles; cardigans; caps; sports caps and hats; belts; sweaters; hats; fashion hats; straw hats; sun hats; cloth hats; knit hats; woolly hats; waterproof hats; knitted hats; socks and stockings; thermal socks; athletic shoes; aqua shoes; outdoor winter shoes; casual footwear; infants' shoes and boots; baby shoes; children's shoes; casual shoes; shirts; polos; short-sleeved shirts; tights; ties; panties; panties [underwear]; baby diaper pants; blanket sleepers; tank tops; scarves; neck scarves; silk scarves; headscarves; scarves for the head; winter gloves; vests; jeans; skirts; skirts and dresses; culottes; bathing suits; coats; wind coats; short coats; winter coats; rain coats; mittens; bow ties; pants; capri pants; short pants; winter pants; snow pants; waterproof pants; baby pants; rain pants; infant pants; casual pants; slippers; small hats; pullovers; hooded pullovers; fleece shirts; pajamas; dresses; dressing gowns; dressing gowns and bathrobes; overalls; shortalls; sandals; beach shoes and sandals; shorts; athletic shorts; boxer briefs; shoes; bras; T-shirts; long-sleeved T-shirts; tunics; jackets; sleeved jackets;

outerwear jackets; winter jackets; beach jackets; jackets and socks; waterproof jackets and pants; waterproof jackets; fleece jackets; sleeveless jackets; hooded jackets; athletic wear; outdoor winter clothing; sleepwear.

Application Number 2,011,058
Language of Application English

Filing Date 2020-02-11

APPLICANT AND AGENT DETAILS

Applicant

The Folger Coffee Company
One Strawberry Lane
Orrville, OH 44667
UNITED STATES OF AMERICA

Agent

MARY GARAVELLOS
(Smucker Foods of Canada Corp.), 80
Whitehall Drive , Markham, ONTARIO, L3R0P3

TRADEMARK DETAILS

MORNING CAFÉ

Trademark Type

Standard Characters

Goods

Class 30

Coffee

Application Number 2,011,137
Language of Application English

Filing Date 2020-02-12

APPLICANT DETAILS

Applicant

National Cold Chain Inc.
56 Romina Dr
Second Floor
Concord
ONTARIO
L4K4Z7

TRADEMARK DETAILS

NCC Logistics

Trademark Type

Standard Characters

Disclaimer

The right to the exclusive use of Logistics is disclaimed apart from the trademark.

Services

Class 35

(1) business administration in the field of transport and delivery; business management consultancy in the field of transport and delivery; business management in the field of transport and delivery

Class 39

(2) freight train transport; freight transportation brokerage; freight transportation by boat; freight transportation by rail; freight transportation by truck; railway transportation of goods; supply chain logistics and reverse logistics services consisting of the transportation of goods for others by air, rail, ship or truck; supply chain logistics and reverse logistics services for the transportation of goods for others by air, rail, ship or truck; transportation of goods by rail; transportation of goods in refrigerated conditions by rail

Application Number 2,011,160
Language of Application English

Filing Date 2020-02-12

APPLICANT AND AGENT DETAILS

Applicant

S&E Gourmet Cuts, Inc.
379 E. Industrial Road
San Bernardino, CA 92408
UNITED STATES OF AMERICA

Agent

BORDEN LADNER GERVAIS LLP
World Exchange Plaza, 100 Queen Street,
Suite 1300, Ottawa, ONTARIO, K1P1J9

TRADEMARK DETAILS

THE GRASS-FED IS ALWAYS GREENER

Trademark Type

Standard Characters

Goods

Class 29

Beef jerky; jerky

Application Number 2,011,176
Language of Application French

Filing Date 2020-02-12

APPLICANT DETAILS

Applicant

Sogi informatique limitée
3550 Boul Kruger
Trois-Rivieres
QUÉBEC
G9A4M3

TRADEMARK DETAILS

Logan

Trademark Type

Standard Characters

Goods

Class 09

computer software for processing digital images

Application Number 2,011,188
Language of Application English

Filing Date 2020-02-12

APPLICANT AND AGENT DETAILS

Applicant

S&E Gourmet Cuts, Inc.
379 E. Industrial Road
San Bernardino, CA 92408
UNITED STATES OF AMERICA

Agent

BORDEN LADNER GERVAIS LLP
World Exchange Plaza, 100 Queen Street,
Suite 1300, Ottawa, ONTARIO, K1P1J9

TRADEMARK DETAILS

COUNTRY ARCHER PROVISIONS

Trademark Type

Standard Characters

Goods

Class 29

Beef jerky; jerky

Application Number 2,011,794
International Registration Number 1513826
Language of Application English

Filing Date 2019-12-10

APPLICANT AND AGENT DETAILS

Applicant

Swisslogo AG
Mülibodenstrasse 3
CH-8172 Niederglatt
SWITZERLAND

Agent

RIDOUT & MAYBEE LLP
11 Holland Avenue, Suite 601 , Ottawa,
ONTARIO, K1Y4S1

TRADEMARK DETAILS

Trademark Type

Design

Visual Representation



Trademark Description

The mark consists of a stylized logo of the conjoined letters "MV", with the word "MAXVAC" appearing below.

Colour Claim

Colour is claimed as a feature of the trademark. The word "MAXVAC" and the horizontal lines forming the letter "V" are black. The letter "M" is blue.

Goods

Class 07

(1) Hand held vacuum cleaners for industrial purposes; vacuum cleaners for industrial purposes; dust exhausting installations for cleaning purposes, namely dust filters for vacuum cleaners, bags for vacuum cleaners, cyclone dust collectors, dust bags for vacuum cleaners; dust removing installations for cleaning purposes, namely air filtering units for removing dust; dust removing installations for cleaning purposes, namely air scrubbers, namely air cleaning apparatus for removal of particles from air flows

Class 11

(2) Dust removing and dust absorbing installations for ventilation purposes.

Application Number 2,012,155
Language of Application French

Filing Date 2020-02-17

APPLICANT DETAILS

Applicant

Odette Ménard
1250 Rue De La Forêt
Longueuil
QUÉBEC
J4N1R7

TRADEMARK DETAILS

Trademark Type

Design

Visual Representation



Goods

Class 10

cases fitted for medical instruments; medical bags designed to hold medical instruments; medical instruments bags

Application Number 2,012,502
Language of Application English

Filing Date 2020-02-19

APPLICANT DETAILS

Applicant

BANDED PEAK BREWING LTD
#119, 519 34th Ave. SE
Calgary
ALBERTA
T2G1V1

TRADEMARK DETAILS

Chinook Saison

Trademark Type

Standard Characters

Goods

Class 21

(1) barbecue mitts; barbecue tongs; beer glasses; beer mugs; beer steins; beverage containers; beverage glassware; bottle openers; cardboard cups; ceramic jugs; ceramic mugs; cleaning cloth; cloths for cleaning; cocktail glasses; cocktail picks; cocktail shakers; cocktail stirrers; coffee cups; coffee mugs; compostable cups; containers for ice; cookware; cooler bags; corkscrews; cups; cups and mugs; cutting boards; decorative glass; drink coasters; drinking bottles for sports; drinking cups; drinking flasks; drinking flasks for travelers; drinking glasses; drinking horns; drinking saucers; drinking steins; glass bars; glass coasters; glass dishes; glass jars; glass tankards; goblets; ice buckets; insulated flasks; insulating sleeve holder for beverage cups; jugs; painted glassware; paper and plastic cups; paper cups; paper plates and paper cups; pitchers; plastic cups; plastic jugs; table glassware; tankards; tankards of precious metal; travel mugs

Class 25

(2) A-shirts; adult pajamas; aprons; athletic apparel; athletic clothing; athletic footwear; athletic shoes; athletic shorts; athletic tights; athletic wear; bandanas; baseball caps and hats; baseball uniforms; bathing suits; beach clothes; beach footwear; belts; boardshorts; coats; curling shoes; exercise wear; gloves; golf wear; gym wear; hats; jumpsuits; maternity wear; overalls; promotional t-shirts; sandals and beach shoes; shirts; shoes; ski wear; sleepwear; sportswear; suits; sweaters; tank tops; team jerseys; team shirts; thong underwear; ties; toques; underwear; work boots; work shoes

Class 32

(3) alcohol-free beers; alcohol-reduced beer; beer; low-alcohol beer; malt beer

Application Number 2,013,007
International Registration Number 1514983
Language of Application English

Filing Date 2020-01-14

APPLICANT AND AGENT DETAILS

Applicant

Shenzhen Aobay Technology Co., Ltd.
Room 432, 4th Floor, Gongyi Building,
Gongyi 432, Shibida-Gongyi Building,
No. 55 Zhenhua Road, Fuqiang Community,
Huaqiangbei Subdistrict
Futian District
CHINA

Agent

JERRY CHEN
166 Berwick Cres, Richmond Hill, ONTARIO,
L4C0B4

TRADEMARK DETAILS

AOBY

Trademark Type

Standard Characters

Goods

Class 09

Time clocks; electronic weighing scales for personal use; measuring rules; recognition apparatus for identifying human faces, namely cameras for human facial recognition, facial recognition software; safety helmets; electronic door locks; electronic burglar alarms; battery charge devices, namely USB chargers, battery chargers for smartphones, battery chargers for tablet computers; light-emitting diodes; integrated circuits; remote controls for televisions; remote controls for stereos; video tapes with recorded animated cartoons.

Application Number 2,013,271
Language of Application English

Filing Date 2020-02-21

APPLICANT AND AGENT DETAILS

Applicant

Waterloo Brewing Ltd.
400 Bingemans Centre Drive
Kitchener
ONTARIO
N2B3X9

Agent

D. MICHAEL BEAN
(Michael Bean Trademark & Copyright Law), P.
O. Box 1737, STN GALT, Cambridge,
ONTARIO, N1R7G8

TRADEMARK DETAILS

ISLAND TIME ANYTIME

Trademark Type

Standard Characters

Goods

Class 33

Alcoholic coolers

Application Number 2,013,320
Language of Application English

Filing Date 2020-02-21

APPLICANT AND AGENT DETAILS

Applicant

CRAYOLA PROPERTIES, INC.
1100 Church Lane
Easton, PA 18044
UNITED STATES OF AMERICA

Agent

GOWLING WLG (CANADA) LLP
SUITE 1600, 1 FIRST CANADIAN PLACE, 100
KING STREET WEST, TORONTO, ONTARIO,
M5X1G5

TRADEMARK DETAILS

**ERUPTING WITH VIBRANT COLOR AND ROCKY
TEXTURE!**

Trademark Type

Standard Characters

Goods

Class 28

toy putty

Application Number 2,013,592
Language of Application English

Filing Date 2020-02-24

APPLICANT AND AGENT DETAILS

Applicant

Alberta Distillers Limited
1521-34 Avenue SE
Calgary
ALBERTA
T2G1V9

Agent

GOWLING WLG (CANADA) LLP
SUITE 2600, 160 ELGIN STREET, OTTAWA,
ONTARIO, K1P1C3

TRADEMARK DETAILS

KEEPER OF THE NORTH

Trademark Type

Standard Characters

Goods

Class 33

Alcoholic beverages, except beer, namely, whisky, gin, vodka, brandy, rum, cordials, liqueurs, spirits distilled from agave

Application Number 2,013,593
Language of Application English

Filing Date 2020-02-24

APPLICANT AND AGENT DETAILS

Applicant

Alberta Distillers Limited
1521 34 Avenue SE
Calgary
ALBERTA
T2G1V9

Agent

GOWLING WLG (CANADA) LLP
SUITE 2600, 160 ELGIN STREET, OTTAWA,
ONTARIO, K1P1C3

TRADEMARK DETAILS

KEEPERS OF THE NORTH

Trademark Type

Standard Characters

Goods

Class 33

Alcoholic beverages, except beer, namely, whisky, gin, vodka, brandy, rum, cordials, liqueurs, spirits distilled from agave

Application Number 2,013,610
Language of Application English

Filing Date 2020-02-24

APPLICANT AND AGENT DETAILS

Applicant

Parachute Digital Solutions Inc. / Parachute
Solutions Numériques Inc.
390 Bay Street
27th Floor
Toronto
ONTARIO
M5H2Y2

Agent

TORYS LLP
SUITE 3000, 79 WELLINGTON ST. W., BOX
270, TD CENTRE, TORONTO, ONTARIO,
M5K1N2

TRADEMARK DETAILS

PARACHUTE SOLUTIONS NUMÉRIQUES

Trademark Type

Standard Characters

Services

Class 36

insurance services

Application Number 2,013,614
Language of Application English

Filing Date 2020-02-24

APPLICANT AND AGENT DETAILS

Applicant

Parachute Digital Solutions Inc. / Parachute
Solutions Numériques Inc.
390 Bay Street
27th Floor
Toronto
ONTARIO
M5H2Y2

Agent

TORYS LLP
SUITE 3000, 79 WELLINGTON ST. W., BOX
270, TD CENTRE, TORONTO, ONTARIO,
M5K1N2

TRADEMARK DETAILS

PARACHUTE DIGITAL SOLUTIONS

Trademark Type
Standard Characters

Services

Class 36

insurance services

Application Number 2,013,672
Language of Application English

Filing Date 2020-02-25

APPLICANT AND AGENT DETAILS

Applicant

BASF SE, a legal entity
Carl-Bosch-Strasse 38
67056 Ludwigshafen am Rhein,
GERMANY

Agent

ROBIC
630, boul. René-Lévesque Ouest, 20e étage,
Montréal, QUEBEC, H3B1S6

TRADEMARK DETAILS

BARIQO

Trademark Type

Standard Characters

Goods

Class 01

(1) Chemicals used in agriculture, horticulture and forestry, namely plant fortifying preparations, chemical or biological preparations for stress management in plants, plant growth regulating preparations, chemical preparations for the treatment of seeds, genes of seeds for agricultural production, surfactants for use in industry namely soil surfactants used to promote uniform movement of water in soil.

Class 31

(2) Agricultural, horticultural and forestry products, namely seeds for agricultural and horticultural purposes, unprocessed grains and vegetative parts of plants being live rootstocks.

Application Number 2,013,779
Language of Application French

Filing Date 2020-02-25

APPLICANT DETAILS

Applicant

Florence Naomi Baghdi
8492 Boul Saint-Michel
Montréal
QUÉBEC
H1Z3E8

TRADEMARK DETAILS

Trademark Type

Design

Visual Representation

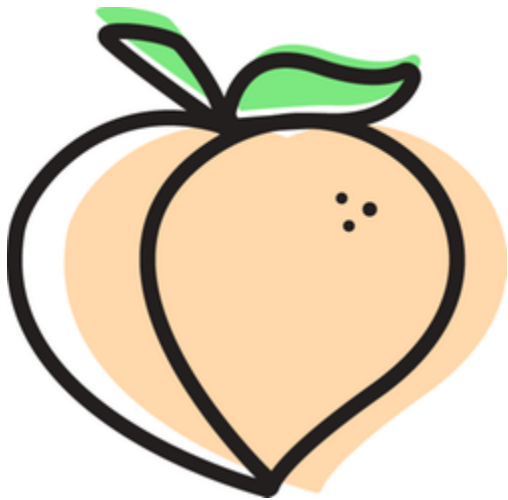

Colour Claim

Colour is claimed as a feature of the trademark. The outline is black, the leaves are green and the peach is yellowish beige with three little dots on the top-right portion.

Services

Class 35

Sale of clothing.

Application Number 2,013,790
Language of Application English

Filing Date 2020-02-25

APPLICANT AND AGENT DETAILS

Applicant

Apex Predator Holdings Inc.
53527 Range Road 181A
Yellowhead County
ALBERTA
T7E3T7

Agent

ROBERT ANTON NISSEN
(Nissen Patent Law), Suite 200, 10328 - 81
Avenue, Edmonton, ALBERTA, T6E1X2

TRADEMARK DETAILS

Flint & Steel

Trademark Type

Standard Characters

Disclaimer

The right to the exclusive use of the words "flint", "steel" is disclaimed apart from the trademark.

Goods

Class 32

(1) beer

Class 33

(2) bourbon; bourbon whiskey; bourbon whisky; malt whiskey; malt whisky; pure malt whiskey; pure malt whisky; rye whiskey; rye whisky; single malt whiskey; single malt whisky; whiskey

Application Number 2,014,198
International Registration Number 1516513
Language of Application French

Filing Date 2019-12-17

APPLICANT AND AGENT DETAILS

Applicant

LAMALO
Moulin d'Yrieux
F-40530 LABENNE
FRANCE

Agent

SMART & BIGGAR LLP
1000 RUE DE LA GAUCHETIERE OUEST,
BUREAU 3300, MONTREAL, QUÉBEC,
H3B4W5

TRADEMARK DETAILS

Trademark Type

Design

Visual Representation

seventy – one 

Goods

Class 03

Cosmetic products; non-medicated dentifrices; perfume products.

Claims

Priority Filing Date: June 21, 2019, Country or Office: FRANCE, Application No: 4561714 in association with the same kind of goods

Application Number 2,014,229
International Registration Number 1516425
Language of Application English

Filing Date 2019-12-20

APPLICANT AND AGENT DETAILS

Applicant

MAZZETTI D'ALTAVILLA S.R.L.
Viale Unità d'Italia 2
I-15041 Altavilla Monferrato (AL)
ITALY

Agent

COLLEEN SPRING ZIMMERMAN
(FOGLER, RUBINOFF LLP), 77 KING
STREET WEST, SUITE 3000, P.O. Box 95,
TORONTO-DOMINION CENTRE, TORONTO,
ONTARIO, M5K1G8

TRADEMARK DETAILS

MAZZETTI D'ALTAVILLA

Trademark Type

Standard Characters

Goods

Class 33

Alcoholic beverages, namely grappa, liqueurs, brandy, gin, wines, whiskey, vodka, rum, fortified wines, bitters, aquavit

Application Number 2,014,284
International Registration Number 1516724
Language of Application English

Filing Date 2020-01-06

APPLICANT AND AGENT DETAILS

Applicant

Symrise AG
Mühlenfeldstr. 1
37603 Holzminden
GERMANY

Agent

SMART & BIGGAR IP AGENCY CO.
SUITE 900, 55 METCALFE STREET, P.O.
BOX 2999, STATION D, OTTAWA, ONTARIO,
K1P5Y6

TRADEMARK DETAILS

SYMESSENCE

Trademark Type

Standard Characters

Goods

Class 01

(1) Chemical additives for use in the manufacture of cosmetics; botanical extracts for use in making cosmetics.

Class 03

(2) Essential oils and aromatic extracts, in particular floral water, namely, extracts of flowers being perfumes; fragrances; fragrance preparations, namely, fragrances for personal use; toiletries, namely, oils for toiletry purposes; body cleaning and beauty care preparations, namely, body and beauty care cosmetics, nonmedicated cleansers for personal use in the nature of skin cleansers; hair care preparations; soaps, namely, non-medicated liquid soaps, non-medicated soap powders, non-medicated soaps for personal use, nonmedicated toilet soaps and non-medicated skin care gels; bath preparations, namely, bath additives, bath creams, bath foams, bath gels, bath oils.

Application Number 2,014,589
Language of Application French

Filing Date 2020-02-27

APPLICANT AND AGENT DETAILS

Applicant

9414-2981 Québec Inc.
101-1405 Transcanada
Montreal
QUÉBEC
H9P2V9

Agent

NATHALY J. VERMETTE
(DS AVOCATS), 1080 Côte du Beaver Hall,
Bureau 2100, Montréal, QUÉBEC, H2Z1S8

TRADEMARK DETAILS

Trademark Type

Design

Visual Representation



Disclaimer

The right to the exclusive use of the word "bières" is disclaimed apart from the trademark.

Goods

Class 21

(1) Glass decanters; glass beer mugs; beer glasses; drinking glasses.

Class 25

(2) Caps; T-shirts; promotional T-shirts; long-sleeved T-shirts.

Class 32

(3) Beers.

Application Number 2,014,629
Language of Application English

Filing Date 2020-02-27

APPLICANT AND AGENT DETAILS

Applicant

Netflix Studios, LLC
5808 W Sunset Blvd
Los Angeles, CA 90028
UNITED STATES OF AMERICA

Agent

CLARK WILSON LLP
900 - 885 WEST GEORGIA STREET,
VANCOUVER, BRITISH COLUMBIA, V6C3H1

TRADEMARK DETAILS

THE PENTAVERATE

Trademark Type

Standard Characters

Services

Class 41

Entertainment services in the nature of a comedic drama television series; providing online non-downloadable video clips and multimedia entertainment recordings containing audio files, video files, artwork, and informational text from and related to a comedic drama television series

Claims

Priority Filing Date: August 30, 2019, Country or Office: JAMAICA, Application No: 078541 in association with the same kind of services

Application Number 2,014,709
Language of Application English

Filing Date 2020-02-28

APPLICANT DETAILS

Applicant

Lucien Georges Lallouz
2000 Island blvd. suite 2005
Aventura, FL 33160
UNITED STATES OF AMERICA

TRADEMARK DETAILS

TEKONIAK

Trademark Type

Standard Characters

Goods

Class 33

agave-based distilled alcoholic beverages;

Application Number 2,015,621
International Registration Number 1517865
Language of Application English

Filing Date 2020-01-08

APPLICANT AND AGENT DETAILS

Applicant

STAIRMEDIA BCN, S.L.
Calle Almogavares, N.º 132-136
E-08018 BARCELONA
SPAIN

Agent

DEETH WILLIAMS WALL LLP
150 YORK STREET, SUITE 400, TORONTO,
ONTARIO, M5H3S5

TRADEMARK DETAILS

Trademark Type

Design

Visual Representation

STAIRMEDIA

Goods

Class 09

(1) Electronic advertising displays, namely, digital advertising signage; electronic display panels for advertising; luminous advertising signs; luminous advertising panels; luminous advertising panels for stairs; luminous signaling panels; luminous signaling panels for stairs; emergency signalling lights; flashing safety lights for stairwells.

Class 11

(2) Lighting apparatus and installations, namely, flat panel lighting and lighting installations; light panels; emergency light panels; emergency light panels for ladders; emergency lighting; emergency lights.

Claims

Priority Filing Date: July 08, 2019, Country or Office: EUIPO (EU), Application No: 018092270 in association with the same kind of goods

Application Number 2,015,826
Language of Application English

Filing Date 2020-03-05

APPLICANT DETAILS

Applicant

Wu Honglin
9-606,Zhongdian Dormitory,Futian Dist.
Shenzhen, 518000
CHINA

TRADEMARK DETAILS

Franato

Trademark Type

Standard Characters

Goods

Class 25

Panties;jackets;Coats;Skirts;Dresses;Trousers;lingerie;Tights;Vests;Camisoles;Underwear;corsets;
brassières;Shoes;slips

Application Number 2,016,006
Language of Application English

Filing Date 2020-03-05

APPLICANT AND AGENT DETAILS

Applicant

STAHL'S INC.
6353 East 14 Mile Road
Sterling Heights, MI 48312
UNITED STATES OF AMERICA

Agent

MILLER IP LAW
84 Neilson Drive, Toronto, ONTARIO, M9C1V7

TRADEMARK DETAILS

A2Z

Trademark Type

Standard Characters

Goods

Class 07

Heat transfer presses; heat transfer presses for applying letters, numbers, graphics, artwork or designs onto garments or other products or surfaces

Claims

Priority Filing Date: February 25, 2020, Country or Office: UNITED STATES OF AMERICA,
Application No: 88/810,190 in association with the same kind of goods

Application Number 2,016,007
Language of Application English

Filing Date 2020-03-05

APPLICANT AND AGENT DETAILS

Applicant

STAHL'S INC.
6353 East 14 Mile Road
Sterling Heights, MI 48312
UNITED STATES OF AMERICA

Agent

MILLER IP LAW
84 Neilson Drive, Toronto, ONTARIO, M9C1V7

TRADEMARK DETAILS

SWINGSHIFT

Trademark Type

Standard Characters

Goods

Class 07

Heat transfer presses; heat transfer presses for applying letters, numbers, graphics, artwork or designs onto garments or other products or surfaces

Claims

Priority Filing Date: February 25, 2020, Country or Office: UNITED STATES OF AMERICA,
Application No: 88/810,194 in association with the same kind of goods

Application Number 2,016,012
Language of Application English

Filing Date 2020-03-05

APPLICANT AND AGENT DETAILS

Applicant

ANTHONY BUCHANAN WINES INC.
300 PINEVIEW ROAD
PENTICTON
BRITISH COLUMBIA
V2A7S1

Agent

ACCUPRO TRADEMARK SERVICES LLP
SUITE 702 - 401 WEST GEORGIA STREET,
VANCOUVER, BRITISH COLUMBIA, V6B5A1

TRADEMARK DETAILS

FUBAR

Trademark Type

Standard Characters

Goods

Class 33

wine

Application Number 2,016,014
Language of Application English

Filing Date 2020-03-05

APPLICANT AND AGENT DETAILS

Applicant

ANTHONY BUCHANAN WINES INC.
300 PINEVIEW ROAD
PENTICTON
BRITISH COLUMBIA
V2A7S1

Agent

ACCUPRO TRADEMARK SERVICES LLP
SUITE 702 - 401 WEST GEORGIA STREET,
VANCOUVER, BRITISH COLUMBIA, V6B5A1

TRADEMARK DETAILS

SNAFU

Trademark Type

Standard Characters

Goods

Class 33

wine

Application Number 2,016,052
Language of Application English

Filing Date 2020-03-05

APPLICANT DETAILS

Applicant
YU HONG HE
One of No. 10 Congyinfang, Liwan District
Guangzhou City, 510000
CHINA

TRADEMARK DETAILS

Trademark Type
Design

Visual Representation



Colour Claim

Colour is claimed as a feature of the trademark. The circular design is red, the stylized wording "Hi" is white, the lemon design is yellow, and the outline of the circular design and lemon design is black.

Services

Class 43

bar services; boarding for animals; booking of campground accommodation; booking of hotel accommodation; booking of temporary campground accommodations; cafeteria services; café services; canteen services; day-nursery services; food sculpting; hotel services; hotels; motel services; providing campground facilities; providing temporary accommodation in boarding houses; providing temporary accommodation in vacation apartments; providing temporary campground accommodations; providing temporary hotel accommodations; providing temporary lodging at holiday camps; rental of chairs, tables, table linen, glassware; rental of holiday cabins; rental of kitchen worktops for preparing food for immediate consumption; retirement home services; tea rooms; temporary accommodation services provided by holiday camps

Application Number 2,016,102
Language of Application English

Filing Date 2020-03-06

APPLICANT AND AGENT DETAILS

Applicant

Boathouse Beverage, LLC
168 Imperial Avenue
Westport, CT 06880
UNITED STATES OF AMERICA

Agent

BERESKIN & PARR LLP/S.E.N.C.R.L., S.R.L.
SCOTIA PLAZA, 40 KING STREET WEST,
40th FLOOR, TORONTO, ONTARIO, M5H3Y2

TRADEMARK DETAILS

BON V!V

Trademark Type

Standard Characters

Goods

Class 33

Flavored brewed malt beverage; hard seltzer

Claims

Priority Filing Date: September 10, 2019, Country or Office: UNITED STATES OF AMERICA,
Application No: 88610732 in association with the same kind of goods

Application Number 2,016,433
Language of Application French

Filing Date 2020-03-09

APPLICANT DETAILS

Applicant

Patrick Telemaque
4575, avenue Charlemagne
Montréal
QUÉBEC
H1X2H3

TRADEMARK DETAILS

Ayke Curcu Ginger

Trademark Type

Standard Characters

Goods

Class 30

maple syrup

Application Number 2,016,532
Language of Application French

Filing Date 2020-03-10

APPLICANT AND AGENT DETAILS

Applicant

DOMAINE POLISSON INC.
201, rang de l'Annonciation
Oka
QUÉBEC
J0N1E0

Agent

BENOÎT & CÔTÉ INC.
560 boul. Crémazie Est, 3e étage, Montréal,
QUÉBEC, H2P1E8

TRADEMARK DETAILS

VINS POLISSON

Trademark Type

Standard Characters

Goods

Class 33

wine

Application Number 2,016,640
Language of Application English

Filing Date 2020-03-10

APPLICANT AND AGENT DETAILS

Applicant

Twisted X, Inc.
1200 South FM 51
Suite E
Decatur, TX 76234
UNITED STATES OF AMERICA

Agent

BERESKIN & PARR LLP/S.E.N.C.R.L., S.R.L.
SCOTIA PLAZA, 40 KING STREET WEST,
40th FLOOR, TORONTO, ONTARIO, M5H3Y2

TRADEMARK DETAILS

Twisted X Boots

Trademark Type

Standard Characters

Goods

Class 25

boots; sandals; shoes;

Application Number 2,016,641
Language of Application English

Filing Date 2020-03-10

APPLICANT AND AGENT DETAILS

Applicant

Twisted X, Inc.
1200 South FM 51
Suite E
Decatur, TX 76234
UNITED STATES OF AMERICA

Agent

BERESKIN & PARR LLP/S.E.N.C.R.L., S.R.L.
SCOTIA PLAZA, 40 KING STREET WEST,
40th FLOOR, TORONTO, ONTARIO, M5H3Y2

TRADEMARK DETAILS

Twisted X

Trademark Type
Standard Characters

Goods

Class 25

boots; sandals; shoes;

Application Number 2,016,914
International Registration Number 1520052
Language of Application English

Filing Date 2019-09-30

APPLICANT AND AGENT DETAILS

Applicant

GreenLight Biosciences, Inc.
200 Boston Avenue, Suite 1000
Medford MA 02155
UNITED STATES OF AMERICA

Agent

MOFFAT & CO.
P.O. Box 2088, Station D, Ottawa, ONTARIO,
K1P5W3

TRADEMARK DETAILS

GREENLIGHT BIOSCIENCES

Trademark Type

Standard Characters

Goods

Class 05

Pharmaceutical products, aquaculture products, and veterinary products for human, aquaculture, and animal health in the nature of vaccines and RNA therapeutics for the treatment of infectious diseases, neurological diseases, metabolic diseases, cardiovascular diseases, respiratory diseases, immune system diseases, and cancer; antibiotics; vaccines; gene therapy products, namely mRNA therapeutics and siRNA therapeutics for medical or clinical use for the treatment of infectious diseases, respiratory diseases, immune system diseases, cardiovascular diseases, and cancer; RNA in the nature of vaccines and therapeutics for scientific, research, medical, pharmaceutical, veterinary, agricultural, aquaculture, chemical and energy production, industrial and manufacturing use for the treatment of infectious diseases, neurological diseases, metabolic diseases, cardiovascular diseases, respiratory diseases, immune system diseases, and cancer.

Services

Class 40

(1) Cell-Free processing and manufacturing for the production of food, beverages, and sugars for others; Cell- Free processing and manufacturing of RNA for others; manufacturing and processing of RNA for others for scientific, research, medical, pharmaceutical, veterinary, agricultural, chemical and energy production, industrial and manufacturing use; biological manufacturing and cell-free processing of RNA for others; manufacturing and processing of RNA delivery formulations for others for scientific, research, medical, pharmaceutical, veterinary, agricultural, chemical and energy production, industrial and manufacturing use.

Class 42

(2) Research and development services in the field of RNA for scientific, engineering, research, medical, pharmaceutical, veterinary, agricultural, industrial and manufacturing; research and development services in the field of synthetic and recombinant biology and formulations namely, RNA formulations for scientific, engineering, research, medical, pharmaceutical, veterinary, agricultural, industrial, and manufacturing; design and engineering in the field of producing RNA and cell-free processing; research and development services in the field of producing,

manufacturing, and processing of RNA and RNA formulations for scientific, engineering, research, medical, pharmaceutical, veterinary, agricultural food, industrial, and manufacturing; research and development services in the field of formulations for the delivery of RNA for scientific, research, medical, pharmaceutical, veterinary, agricultural, industrial and manufacturing use.

Claims

Priority Filing Date: March 28, 2019, Country or Office: UNITED STATES OF AMERICA,
Application No: 88361013 in association with the same kind of goods and in association with the same kind of services

Application Number 2,017,379
Language of Application English

Filing Date 2020-03-12

APPLICANT AND AGENT DETAILS

Applicant

GRUPO BIMBO, S.A.B. DE C.V.
Prolongación Paseo de la Reforma No. 1000
Colonia Peña Blanca Santa Fe
C.P. 01210, México Distrito Federal,
MEXICO

Agent

SMART & BIGGAR LLP
1100-150 York street, TORONTO, ONTARIO,
M5H3S5

TRADEMARK DETAILS

BIMBO ART&SANO

Trademark Type

Standard Characters

Goods

Class 30

bread, cakes, and cookies

Application Number 2,017,521
Language of Application English

Filing Date 2020-03-13

APPLICANT AND AGENT DETAILS

Applicant

Inaba Shokuhin Co., Ltd.
114-1, Yui-Kitada, Shimizu-ku
Shizuoka-shi, Shizuoka, 421-3104
JAPAN

Agent

BERESKIN & PARR LLP/S.E.N.C.R.L., S.R.L.
SCOTIA PLAZA, 40 KING STREET WEST,
40th FLOOR, TORONTO, ONTARIO, M5H3Y2

TRADEMARK DETAILS

Trademark Type

Design

Visual Representation



Colour Claim

Colour is claimed as a feature of the trademark. The letters are in red.

Goods

Class 31

Pet foods, such as dog food and cat food.

Application Number 2,018,152
International Registration Number 1520100
Language of Application English

Filing Date 2019-10-11

APPLICANT AND AGENT DETAILS

Applicant

Marshall Amplification Plc
Denbigh Road,
Bletchley
Milton Keynes MK1 1DQ
UNITED KINGDOM

Agent

LAVERY, DE BILLY, LLP
1 Place Ville Marie, Suite 4000, Montréal,
QUEBEC, H3B4M4

TRADEMARK DETAILS

Trademark Type

Design

Visual Representation



Goods

Class 14

(1) Metal key holders.

Class 18

(2) Leather and imitations of leather, animal skins and hides, luggage, umbrellas and parasols, walking sticks, whips, harness and saddlery, collars, leashes and clothing for animals, bags for umbrellas, bags made of imitation leather, bags made of leather, belt bags, beach bags, barrel bags, book bags, cabin bags, rucksacks, courier bags, cross-body bags, duffle bags, roller bags, shopping bags, tote bags, satchels, fanny packs, carryalls, cases of imitation leather, carriers for suits, shirts and dresses, beauty cases, make-up bags, suitcases, travel bags, all-purpose sports bags, backpacks, briefcases, wallets, not of precious metal, wallets of precious metal, ankle-mounted wallets, wrist-mounted wallets, wallets with card compartments, banknote holders, card wallets, coin purses, calling card cases, key wallets, leather boxes, pet hair bows, muzzles, garments for pets, electronic pet collars, baggage, business card cases, cases for keys, cases for holding keys, leads for animals, luggage tags, music bags, music cases, metal luggage tags, metal parts of umbrellas, clothing for pets, pet leads, pocket wallets, pocketbooks, protective suit carriers, whips and apparel for animals, toiletry bags, tie cases, articles of luggage, gentlemen's handbags, ladies handbags, handbags made of imitation leather, handbags made of leather, handbags, not of precious metal, leather bags and wallets, imitation leather bags, leather briefcases, attache cases made of imitation leather, attache cases made of leather, leather shopping bags, textile shopping bags, knitted bags, bags for travel, roller suitcases, luggage bags, overnight bags, holdalls, suit bags, airline travel bags, hiking bags, hiking rucksacks, bags for school, reusable shopping bags, wheeled shopping bags, messenger bags, all-purpose carrying bags, fashion handbags, evening handbags, boston bags, changing bags, clutch bags, shoulder

bags, sling bags, evening bags, clutch purses, evening purses, wrist mounted purses, small bags for men, portmanteaux, valises, bum bags, attaché cases, haversacks, cosmetic bags, cosmetic purses, travelling cases, make-up cases, shaving bags sold empty, wash bags (not fitted), travel cases, wallets for attachment to belts, creditcard holders, change purses, tags for luggage, hat boxes of leather, parts and fittings for all the aforesaid goods.

Application Number 2,018,176
International Registration Number 1520822
Language of Application English

Filing Date 2019-11-08

APPLICANT AND AGENT DETAILS

Applicant

Rob Halford Music Limited
c/o Lee & Thompson LLP,
4 Gee's Court, St Christopher's Place
London W1U 1JD
UNITED KINGDOM

Agent

WILSON LUE LLP
250 University Avenue, 5th Floor, Toronto,
ONTARIO, M5H3E5

TRADEMARK DETAILS

METAL GOD

Trademark Type

Standard Characters

Goods

Class 14

(1) Precious metals and their alloys; jewellery, precious stones; horological and chronometric instruments, namely watches and clocks; watches, watch bands, dog tags, clocks, jewelry boxes, medallions, medals, pet jewelry, ornamental lapel pins and sun dials

Class 25

(2) Clothing, namely, T-shirts, sweatshirts, jackets, hats and baseball caps, shirts, hooded tops, hooded sweatshirts, pullovers, jumpers, shorts, boxer shorts, boxer briefs, underwear, underclothes, under garments, socks, scarves, dressing gowns, pyjamas, dungarees, braces as suspenders, ties, lingerie, hosiery, bathing costumes, bathing suits, bathing trunks, bathrobes, gloves, jeans, kilts, nightwear, trouser suits, slacks, sleeping garments, sleepwear, suits, swim wear, swimsuits, trousers, tuxedos and waistcoats, legging, baby bibs not of paper, baby bodysuits, baby bottoms, baby tops, baby rompers, belts, Bermuda shorts, bikinis, blazers, blouses, body shapers, bomber jackets, bras, briefs, cagoules, camisoles, cargo pants, coats, costumes for use in role-playing games, costumes for use in children's dress up play, crop pants, crop tops, dance costumes, dresses, housecoats, ear bands, ear muffs, ear warmers, evening dresses, evening gowns, G-strings, Halloween costumes, infant and toddler one piece clothing, infant sleepers being clothing, infantwear, knee highs, knickers, ladies' underwear, skirts, miniskirts, negligees, nightshirts, nightgowns, nighties, nightwear, panties, pants, stockings, suspenders, play suits, polo shirts, rain wear, school uniforms, tankinis, thong underwear and tights; headgear, namely, caps, beanies, skull caps, skullies being headwear and bandanas; footwear, namely, shoes, canvas shoes, sneakers, boots, slippers and flip-flops, beach footwear, beach shoes, boots, booties, dance shoes, dance slippers, moccasins and pumps

Services

Class 41

Education, namely, providing training and conducting seminars, workshops, lessons, classes and lectures in the fields of music, song writing, song composition, music video production, musical

arrangement, singing and vocal performances, and playing and programming musical instruments, musical apparatus and musical equipment, and information and advisory services relating to the aforesaid services; providing information in the field of entertainment relating to a recording artist via an online network, and information and advisory services relating to the aforesaid services; entertainment in the form of personal appearances by a musical performer, and televised and movie appearances by a professional entertainer, and information and advisory services relating to the aforesaid services; ticket reservation and booking of seats for entertainment, sporting and cultural events, and information and advisory services relating to the aforesaid services; entertainment in the nature of ongoing television programs relating to music, ongoing animated television programs, and live musical performances, and information and advisory services relating to the aforesaid services; recorded and live musical, dramatic and comedy entertainment services, and information and advisory services relating to the aforesaid services; organisation and production of audio and visual shows, programmes and recordings, and information and advisory services relating to the aforesaid services; organisation and production of stage and theatrical performances and concerts, and information and advisory services relating to the aforesaid services; theatre ticket agency services, and information and advisory services relating to the aforesaid services; production of radio and television shows and programmes, and information and advisory services relating to the aforesaid services; production and distribution of film, video and sound recordings, and information and advisory services relating to the aforesaid services; arranging and conducting exhibitions, shows and tours for entertainment purposes featuring music and musical performances, and information and advisory services relating to the aforesaid services; fan club services, and information and advisory services relating to the aforesaid services; publication of books, songbooks, sheet music, comics and periodicals, and information and advisory services relating to the aforesaid services

Application Number 2,018,225
International Registration Number 1521296
Language of Application French

Filing Date 2019-12-17

APPLICANT AND AGENT DETAILS

Applicant

ETS. JOSKIN SA
Rue de Wergifosse 39
B-4630 Soumagne
BELGIQUE

Agent

LAVERY, DE BILLY, LLP
1 Place Ville Marie, Suite 4000, Montréal,
QUÉBEC, H3B4M4

TRADEMARK DETAILS

Trademark Type

Design

Visual Representation

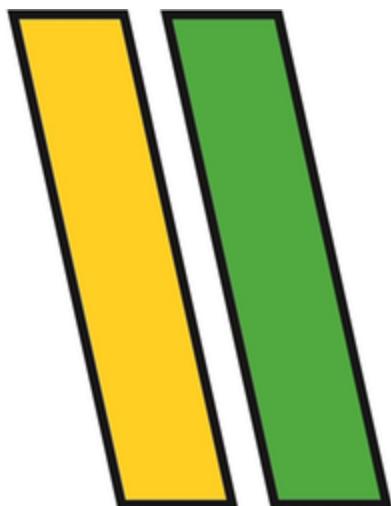

Colour Claim

Colour is claimed as a feature of the trademark. Yellow and green are claimed as features of the trademark. The mark consists of two rectangles placed next to each other and outlined in black; the one on the left is yellow, and the one on the right is green.

Goods

Class 07

(1) Agricultural machines, namely cultivators, slurry injectors, slurry incorporators, slurry spraying bars, silo unloaders, silage dispensers, fodder mixers, pasture mulchers, flail mowers, fallow choppers, brush grinders, grass harrows, weeders, meadow aerators, weed control machines for cereal crops, dispensers using harrows, namely agricultural seed planting machines, fertilizer spreading machines; agricultural implements, other than hand-operated implements, namely trailer-mounted augers, blades used as machine parts, blades for meadow trimmers, meadow choppers, pasture toppers and brush grinders, centrifugal pumps for spreading slurry and liquid manure,

pressure regulators used as machine parts, valves used as machine parts, pressure valves used as machine parts, mechanical, hydraulic and pneumatic jacks, slurry grinding machines, namely sludge mixers, sludge collectors [machines], slurry choppers, hydrocleaners [machines].

Class 12

(2) Utility trailers, cargo trailers, refrigerated trailers; tipping trailers, dump trucks; tractors; carts, handling carts, lift trucks.

Class 25

(3) Clothing, namely jackets, fluorescent jackets, coats, vests, pullovers, polo shirts, T-shirts, shirts, overalls, pants, shorts, waterproof clothing, namely rainwear, sun protective clothing, sleepwear, skiwear, leisurewear, athletic wear, work shoes, work boots, caps, hats, skull caps, gloves, scarves, ties, all the aforesaid goods being for promotional use in connection with farm mechanization.

Class 28

(4) Scale-model agricultural vehicles, machines and implements.

Claims

Priority Filing Date: June 19, 2019, Country or Office: Benelux Office for IP (BOIP), Application No: 01397587 in association with the same kind of goods

Application Number 2,018,622
Language of Application English

Filing Date 2020-03-19

APPLICANT AND AGENT DETAILS

Applicant

Henkel Corporation
One Henkel Way
Rocky Hill, CT 06067
UNITED STATES OF AMERICA

Agent

SMART & BIGGAR LLP
SUITE 900, 55 METCALFE STREET, P.O.
BOX 2999, STATION D, OTTAWA, ONTARIO,
K1P5Y6

TRADEMARK DETAILS

DIAL CLEAN + GENTLE

Trademark Type

Standard Characters

Goods

Class 03

Bar soap; hand soap, non-medicated liquid soap, body wash

Application Number 2,018,799
Language of Application English

Filing Date 2020-03-20

APPLICANT AND AGENT DETAILS

Applicant

MAG CANADA BEVERAGE LTD.
Unit 100 - 565 Great Northern Way
Vancouver
BRITISH COLUMBIA
V5T0H8

Agent

GOWLING WLG (CANADA) LLP
550 BARRARD STREET, SUITE 2300,
VANCOUVER, BRITISH COLUMBIA, V6C2B5

TRADEMARK DETAILS

WHITE CLAW BREWPURE

Trademark Type

Standard Characters

Goods

Class 32

(1) ale; beer; beer-based cocktails; flavoured beers; lager; porter; stout;

Class 33

(2) alcoholic cocktails; alcoholic cocktails in the form of chilled gelatins; alcoholic coolers; alcoholic fruit drinks; alcoholic lemonade; alcoholic malt-based coolers; alcoholic punches; alcoholic seltzer; hard seltzer; vodka seltzer;

Application Number 2,019,026
Language of Application French

Filing Date 2020-03-23

APPLICANT DETAILS

Applicant

Alexis Nivet
1696 Rang De La Seigneurie
Sainte-Émélie-de-l'Énergie
QUÉBEC
J0K2K0

TRADEMARK DETAILS

Alexis et Propolis

Trademark Type

Standard Characters

Goods

Class 30

royal jelly; honey; herbal honey; bee glue

Application Number 2,019,672
International Registration Number 1270967
Language of Application English

Filing Date 2020-02-20

APPLICANT AND AGENT DETAILS

Applicant

Moomin Characters Oy Ltd
Salmisaarenranta 7 M
FI-00180 Helsinki
FINLAND

Agent

HEIDI JENSEN
(JENSEN IP), 103 - 2150 Thurston Drive,
Ottawa, ONTARIO, K1G5T9

TRADEMARK DETAILS

MOOMIN

Trademark Type

Standard Characters

Goods

Class 09

(1) Magnifying glasses; digital bathroom scales; hourglasses; binoculars; bicycle helmets; digital egg timers; baby monitors; DVD players and recorders; earphones and headphones; mp3 players; mp4 players; loudspeakers; headphones; microphones; audio cassette players and recorders; CD players and recorders; audio speakers; digital audio tape players and recorders; audiovisual receivers; digital photo frames; disposable cameras; digital cameras; blank USB cards; blank USB flash drives; data storage devices being cassettes, floppy discs or magnetic tapes; flash memory cards; digital camera memory cards; blank CDs; blank DVDs; blank CD-ROMs; blank smart cards; calculators, smart watches; electronic pens; interactive whiteboards; computers; downloadable computer game software; educational software for children; computer software platforms for social networking; computer tablets; spectacles, sunglasses; cases for spectacles and sunglasses; reflective apparel and clothing for the prevention of accidents; reflective safety bands to be worn on the body; bags, cases and sleeves for storing and carrying telephones, computers, mp3 players, CD players, DVD players, headphones and cameras; games software; audio tapes featuring music; pre-recorded DVDs containing movies, television shows, music or computer games; pre-recorded CD-ROMs containing movies, television shows, music or computer games; music recordings; CDs containing movies, television shows, music or computer games; books recorded on disc; books recorded on tape; downloadable electronic books; downloadable music; digital books downloadable from the Internet; downloadable digital content being images, movies, music audios, music videos, TV shows, movies, animations; downloadable electronic greeting cards; coloring and drawing computer programs featuring learning activities of creative expression for children; downloadable electronic games for use with mobile telephones, handheld computers and tablet computers and computer game programs; cinematographic films, animated films; downloadable electronic publications in the form of newsletters and educational materials; downloadable television shows and movies; downloadable motion pictures; downloadable animated cartoons; digital book readers; digital thermometers, not for medical purposes; encoded debit cards, credit cards and payment cards; life jackets; decorative magnets; mouse mats; CD and DVD holders and storage wallets; straps for telephones, computers, mp3 players, CD players,

DVD players, headphones and cameras; covers for mobile phones, portable computers and tablets: magnetic labels.

Class 16

(2) Paper, cardboard; booklets; diaries; cartoon prints; children's arts and crafts paper kits; bookbinding material; photographs; paper stationery; adhesives for stationery or household purposes; artists' easels; artists brushes; art kits comprising colored pencils, paint brushes, markers, graphite pencils, pencil sharpeners, erasers, drawing pads and coloring pages; paint brushes; typewriters and paperclips; boxes for pens; correcting tapes; cards being teaching materials; writing boards; drawing boards; lunch bags of plastic; general purpose plastic bags; envelopes of plastic for packaging; plastic materials for packaging in the nature of bags and film; packing paper, wrapping paper; paper bows for gift wrapping; paper gift wrapping ribbons; gift tags of paper; lunch bags of paper; cardboard boxes; bags of paper; envelopes; docketts made of paper or cardboard; scrapbooks, photographic albums; whiteboards having magnetic properties; books, notebooks, story books, activity books, comic strips, colouring books, children's activity books; comic magazines; greeting and note cards; calendars; parchment paper; paper wipes for cleaning; tissues of paper; table napkins of paper; paper table linens; coasters of paper or cardboard; mats of card or cardboard; pens, penholders; drawing rulers; desk pads; writing instruments; pencil cases and boxes; rubber erasers; paper pads, books; postcards; posters; occasion cards; bookends; bookmarkers; folders for papers; ink stamps; rubber stamps; sealing stamps; paper flags; signboards of paper or cardboard; gift bags of paper or plastic; gift boxes of cardboard or paper; gift wraps and gift wrap paper; stickers [stationery]; party decorations of paper; stencils for decorating food and beverages; party ornaments of paper; decorations for pencils; cardboard party decorations; periodicals; printed publications in the field of movies and cartoons; newspapers, periodicals; pastel crayons; pastes and glues for stationery and household purposes; adhesive tapes for stationery or household purposes; tape dispensers; gummed tape for stationery or household purposes; colour pencil sets; document portfolios; stationery folders, including file folders, folders of paper and folders for letters; stamp and coin albums; toilet paper and kitchen roll; paper doilies; dry erase writing boards.

Class 20

(3) Bedroom furniture; dining room furniture; kitchen furniture; bathroom furniture; living room furniture; outdoor furniture; mirrors; hand-held mirrors; sculptures made from plastic; tables and chairs; bolsters; mobiles being decorative articles; coat pegs [wall mounted hooks] non-metallic; cupboards and storage boxes made from wood; clothes racks; bottle racks; hat racks; key racks; magazine racks; moveable metal storage racks; moveable non-metallic storage racks; plant racks; storage racks; towel racks; seats for children; children's bedroom furniture; beds, bed linen, mattresses, pillows and cushions; decorative boxes made of wood; decorative mobiles made of wood; decorative spheres of wood; presentation boards; pin boards of cork; bulletin boards; clothes hangers and clothes hooks; door fittings, not of metal; window fittings, not of metal; gate fittings, not of metal; bassinets; boxes of wood or plastic; containers, not of metal, for storage; containers, not of metal for transport; pet beds and pet furniture.

Class 21

(4) Cooking utensils; cookware; turners; cutting boards for the kitchen; kitchen enamelware; spatulas for kitchen use; ladles for kitchen use; all-purpose portable household containers; baking containers; food and beverage containers for household use; heat-insulated containers for beverages; bakeware; coffee and tea sets; baby cups and bowls; baking containers; basting spoons; beverage containers; beverage glassware; bottle openers; bread baskets for household purposes; cake stands; chinaware; chopsticks; coasters of porcelain; containers of paper for

baking; cookery molds; cream and sugar sets; crockery; cups; dinnerware; dishes; drinking straws; earthenware; fitted picnic baskets, including dishes; glass dishes; graters for household purposes; ice cream scoops; ovenware; pastry molds; pepper pots, sugar bowls and salt shakers; serving dishes; hair combs; mustache combs; eyelash combs; combs for animals; all-purpose scouring sponges; bath sponges; body sponges; cosmetic sponges; toilet sponges; kitchen cleaning sponges; hair brushes; bath brushes; bottle brushes; brushes for footwear; brushes for pets; clothes brushes; cosmetic brushes; dishwashing brushes; dusting brushes; floor brushes; pastry brushes; tooth brushes; cleaning, dusting and polishing cloths; cleaning mitts; mugs; water bottles sold empty; glass bottles; drinking bottles for sports; reusable plastic water bottles sold empty; refrigerating bottles; vacuum bottles; statues of china or glass; disposable table plates; disposable aluminum foil containers for household purposes; biodegradable cups; biodegradable bowls; biodegradable trays; pots, pans, oven dishes; serving trays; valet trays for household purposes; cabaret trays; plates, beverage glassware; dishes for cooking, not of metal; potholders; candlesticks; candle rings; storage jars; piggy banks; works of art made of glass; toothbrushes and toothbrush holders; cosmetic spatulas; fitted toiletry bags; soap holders and boxes; facial tissue dispensers; dispensers for liquid soap for household purposes; coupe bowl and vases; gardening articles namely gardening gloves, jars, jugs, pots, flower baskets and plant baskets; works of art of porcelain, ceramic, earthenware, terra-cotta and glass; sculptures of porcelain and glass.

Class 25

(5) Casual and athletic clothing; baby clothing; children's clothing; sun protective clothing; children's footwear; shoes; casual footwear; socks and hosiery; hats; caps; winter hats; face masks being clothing; belts [clothing], garters; ties; scarves and bandanas; tights; knitted caps, caps with visors; gloves, mittens; outdoor winter clothing; rainwear; coats; overalls; boots; slippers; blousons, shirts, pants, skirts, shorts, jackets; pyjamas; clothing for children; baby gowns; underwear, pants, brassieres; bath robes, dressing gowns; aprons [clothing]; masquerade costumes; swimming costumes; fancy dress outfits being children's playthings.

Class 28

(6) Card games; toy card games; board games; dice games; educational games for children; electronic educational teaching games for children; interactive board games; memory games; marbles for games; paddle ball games; ring toss games; trading card games; word games; toy scooters; puzzles; balls for sports; snow sleds; arm floats for swimming; children's inflatable swimming pools; floats for swimming; decorations for Christmas trees; plush toys; baby multiple activity toys; baby toys; bath toys; beach toys; bean bag toys; collectable toy figures; electronic learning toys; musical toys; educational toys; figurines being toys; inflatable toys; pet toys; pop-up toys; pull toys; push toys; ride-on toys; rubber toys; sandbox toys; soap bubbles being toys; soft toys; stacking toys; toy bakeware; toy balloons; toy binoculars; toy blocks; toy bucket and shovel sets; toy boxes; toy clocks; toy cookware; toy cutlery; toy figures; toy furniture; toy houses; toy microphones; toy mobiles, toy musical instruments; toy music boxes; toy telephones; toy watches; toy whistles; toys adapted for educational purposes; toys designed to be attached to strollers, high chairs, car seats; stuffed toys, puppets, water toys, wooden toys, toys made of plastics; children's multiple activity toys; bags specially adapted for sports equipment; hand-held electronic games; hand-held units for playing electronic games; computer game joysticks; computer game consoles; electronic educational game machines designed for children; electronic hand-held game units; game controllers in the nature of keyboards specially adapted for playing video games; gaming headsets specially adapted for use in playing video games; gaming keypads; hand held units for playing video games; hand-held units for playing electronic games; joypads for use with electronic games; motion controllers for computer and video games; fishing rods; fishing floats; fishing lures; landing nets for fishing; party balloons; jigsaw puzzles; dolls; fairground and playground apparatus,

namely swings, slides, climbing frames and walls; playground sandboxes; playing cards; nine man's morris sets; toy action figurines; practical joke novelty toys; inflatable swimming pools for recreational use [toys]; electric action toys; snow skis, ice skates, roller skates, snow boards; flippers for swimming or swimming floats; hand held units for playing video games; video game consoles; video game controllers; video game joysticks; gamepads for video games; bags specially adapted for hand-held video game apparatus; bags specially adapted for handheld video games.

Services

Class 35

(1) Business management; business administration; retail sale of clothes, home textile goods, namely curtains, rugs, blankets and pillows, furniture, crafts, stationery, school supplies, office requisites, linens, fabric, furniture and upholstery fabrics, bags, beauty products, cooking utensils, cutlery, all-purpose portable household containers, food and beverage containers for household use, heat-insulated containers for beverages, bakeware, coffee and tea sets, baby cups and bowls, baking containers, beverage containers, beverage glassware, bottle openers, cake stands, chinaware, chopsticks, coasters of porcelain, containers of paper for baking, cookery molds, cream and sugar sets, crockery, cups, dinnerware, dishes, drinking straws, earthenware, fitted picnic baskets including dishes, glass dishes, graters for household purposes, ice cream scoops, ovenware, pastry molds, pepper pots, sugar bowls and salt shakers, piggy banks, pots and pans, serving dishes, toys, video games, children's games, cosmetic products and works of art; administration of business of retail stores; online advertising for others via a computer communications network; organization and management of customer loyalty programs; promoting the sale of goods and services through a consumer loyalty program; providing customer incentive award programs; administration of business of franchises.

Class 41

(2) Providing language training through a website; entertainment in the form of live musical concerts; entertainment in the form of television shows; entertainment services in the nature of live theatrical performances; entertainment services in the nature of live meet-and-greet performances by costumed characters; entertainment services in the nature of non-downloadable television shows and movies transmitted via the internet; entertainment services, namely, providing online electronic games; entertainment services, namely, providing temporary use of non-downloadable computer games; organization of electronic games competitions; organizing and hosting concerts; publishing of electronic publications online and over a global computer network; production and development of cinematographic films, animations, animated cartoons and of television programs; event planning services; organization of museum exhibitions and museum event; publication of books, booklets, magazines, almanacs and journals; online publication of electronic books and journals; providing non-downloadable fiction books and fiction audiobooks via a website; providing online non-downloadable comic books; music production services; production of plays; provision of online computer games; amusement and theme park services; fan club services; providing information online on entertainment in the field of computer games, video games, card games, animated cartoons, comics, novels and magazines; online library services.

Class 43

(3) Food and drink catering; cafeterias; restaurant services; hotel services.

Application Number 2,020,852
Language of Application English

Filing Date 2020-04-02

APPLICANT DETAILS

Applicant

Shanghai Quangong Business Consulting Co.,
Ltd.
Room 202, No.35, Lane 899,
Jinqiao Road, Pudong New Area,
Shanghai, 200120
CHINA

TRADEMARK DETAILS

Gnognauq

Trademark Type

Standard Characters

Goods

Class 16

artists' material molds for modeling clays; bookbinding cloth; bookbinding cords; bookbinding material; correcting fluids; decals; drafting curves; drawing pins; flags of paper; note cards; paper; paper clips; paper gift wrapping ribbons; paper lace; silk canvas for painters; stencil paper; stickers; table linen of paper; thumbtacks; viscose sheets for wrapping

Application Number 2,021,410
Language of Application English

Filing Date 2020-04-08

APPLICANT AND AGENT DETAILS

Applicant

DiaMentis Inc.
2875, boulevard Laurier
bureau D1-1100
Québec
QUEBEC
G1V2M2

Agent

NORTON ROSE FULBRIGHT CANADA LLP/S.
E.N.C.R.L.,S.R.L.
COMPLEXE JULES-DALLAIRE/TOUR
OGILVY RENAULT , BUREAU 1500, 2828,
BOULEVARD LAURIER, QUÉBEC, QUEBEC,
G1V0B9

TRADEMARK DETAILS

RSPA

Trademark Type

Standard Characters

Services

Class 44

Medical clinic services; Medical consultations in the field of mental health; Medical counseling in the field of mental health; Medical diagnostic testing, monitoring and reporting services; Medical clinic providing evaluations and solutions in the field of mental health; Mental health therapy services.

Application Number 2,021,591
International Registration Number 1524947
Language of Application English

Filing Date 2019-12-13

APPLICANT AND AGENT DETAILS

Applicant

The Trade Desk, Inc.
42 N. Chestnut Street
Ventura CA 93001
UNITED STATES OF AMERICA

Agent

ERIC MACRAMALLA
(GOWLING WLG (Canada) LLP), 160 Elgin
Street, Suite 2600, Ottawa, ONTARIO, K1P1C3

TRADEMARK DETAILS

MEDIA FOR HUMANKIND

Trademark Type

Standard Characters

Services

Class 35

(1) Advertising services, namely, placement and dissemination of advertising for others via an on-line communications network on the internet; business marketing consulting services, promotions promoting the goods and services of others through advertisements on Internet websites, and advertising and business management consultancy; arranging and conducting advertising campaign management services for the products and services of others in the nature of tracking, analyzing, and reporting on consumer data, demographics, and consumer behavioral information, computer network use and users for business purposes, and consumer responses to advertisements and promotional materials; management and compilation of computerized databases, namely, creating and managing customer lists and customer data in a computer database for others; conducting market research and consumer research; consumer purchase and behavior research services; advertising research services; advertising and advertisement services of the goods and services of others; advertising by transmission of online publicity for third parties through electronic communications networks; advertising of the goods and services of others via the Internet; dissemination of advertising for others via the Internet; mediation of advertising for others; media research services, namely, providing consumer audience viewership of advertising, advertising sales effectiveness, and selection of media to optimize sales results for business purposes via an Internet-based database; marketing research and analysis services.

Class 42

(2) Providing online non-downloadable software for tracking, managing, and optimizing advertising and promotional campaigns, and calculating return on investment in connection with the same; providing online non-downloadable software for tracking website traffic, e-commerce activity, customer loyalty, and sales conversion rates; providing online non-downloadable computer software for managing, collecting, monitoring and analyzing web sites for others, blog for others and online web site traffic for others, all in the field of business advertisement and management; design and development of computer software for others for managing, collecting, monitoring and analyzing web, blog and other online site traffic, user preferences and links; software-as-a-service (SaaS) services featuring computer software for digital media measurement, website audience

analysis and advertising, namely, to determine the audience affected by advertisements, in the field of business management and advertising; software-as-a-service (SaaS) featuring computer software that collects, manages, integrates, analyzes, monitors, and tracks the performance of websites through web user interactional behavior in the field of web computer system analysis.

Application Number 2,022,186
Language of Application French

Filing Date 2020-04-12

APPLICANT DETAILS

Applicant

Dino Pilote
665, Principale
Joly
QUÉBEC
G0S1M0

TRADEMARK DETAILS

Créations Pilote

Trademark Type

Standard Characters

Goods

Class 25

sweaters; team shirts; sports jerseys and breeches for sports; fleece pullovers; skorts; short pants; shorts; athletic shorts; children's clothing; sports clothing

Application Number 2,022,306
Language of Application English

Filing Date 2020-04-14

APPLICANT DETAILS

Applicant

Whitney Hughes
273 New Russell Rd
New Ross
NOVA SCOTIA
B0J2M0

TRADEMARK DETAILS

East Coast Equestrian

Trademark Type

Standard Characters

Goods

Class 16

(1) decals; stickers

Class 25

(2) athletic clothing; casual clothing; hats; outdoor winter clothing; socks

Application Number 2,022,364
Language of Application French

Filing Date 2020-04-14

APPLICANT AND AGENT DETAILS

Applicant

EssilorLuxottica Canada Inc.
371 Rue Deslauriers
Montréal
QUÉBEC
H4N1W2

Agent

LAVERY, DE BILLY, LLP
1 Place Ville Marie, Suite 4000, Montréal,
QUÉBEC, H3B4M4

TRADEMARK DETAILS

BLU ADVANCE

Trademark Type

Standard Characters

Goods

Class 09

eyeglass lenses

Application Number 2,022,431
Language of Application French

Filing Date 2020-04-14

APPLICANT DETAILS

Applicant

Normand Bergeron
42, Alexandre
Fermont
QUÉBEC
G0G1J0

TRADEMARK DETAILS

Trademark Type

Design

Visual Representation



Colour Claim

Colour is claimed as a feature of the trademark. The letter O, represented by a current of water, is blue and is followed by the letters NORM in black set against a white background.

Goods

Class 01

(1) Media filters for the water treatment industry; chemical oxidants for waste water treatment; chemicals for use in the treatment of waste water.

Class 05

(2) Microbicides for wastewater treatment.

Class 11

(3) Bioreactors for use in the treatment of wastewater; aquarium filters; swimming pool filters; filters for drinking water; water treatment plant filters; water filters for household use; water filters for industrial use; waste water disposal installations; sewage disposal plants; sewage disposal plants; rainwater purification installations; sewage treatment plants; water purification machines for household use.

Services

Class 40

Water and sewer management; water recycling; waste water reprocessing; waste water treatment; electrolysis of water.

Application Number 2,022,502
Language of Application English

Filing Date 2020-04-14

APPLICANT DETAILS

Applicant

Blulyfe Inc.
44A Saint Georges Blvd
M9R1X2
Toronto
ONTARIO
M9R1X2

TRADEMARK DETAILS

Trademark Type

Design

Visual Representation



Goods

Class 18

credit card wallets; credit card wallets of leather; handbags, purses and wallets; key wallets; leather bags and wallets; leather credit card wallets

Application Number 2,023,286
Language of Application English

Filing Date 2020-04-17

APPLICANT DETAILS

Applicant

Doremiel
80 Sunway Square
Markham
ONTARIO
L3P7X5

TRADEMARK DETAILS

DOREMIEL

Trademark Type

Standard Characters

Goods

Class 03

lotions for face and body care; moisturising skin lotions; moisturizing skin lotions; skin care creams; skin care lotions; skin cleansers; skin creams; skin lightening creams; skin lotions; skin masks; skin masks for cosmetic purposes; skin moisturisers; skin moisturizer masks; skin moisturizers; skin moisturizing cream; skin toners

Application Number 2,023,536
Language of Application English

Filing Date 2020-04-21

APPLICANT DETAILS

Applicant

Jimmy Salibi
1454 Rue Cunard
Laval
QUEBEC
H7S2B7

TRADEMARK DETAILS

JIM LE BARBIER

Trademark Type

Standard Characters

Services

Class 44

barber services; barber shop services; barbershops

Application Number 2,023,870
International Registration Number 1526142
Language of Application English

Filing Date 2019-12-18

APPLICANT AND AGENT DETAILS

Applicant

ASRY TEKSTIL SANAYI VE TICARET
LIMITED SIRKETI
Firuzköy Mahallesi,
Aziz Caddesi, No.24, B Blok
Avcilar - Istanbul
TURKEY

Agent

NEOMARK LTD.
7450 rue Saint-Hubert, Montréal, QUEBEC,
H2R2N3

TRADEMARK DETAILS

Trademark Type

Design

Visual Representation

DOREANSE

Goods

Class 18

(1) Leather, unworked or semi-worked; animal skins, unworked or semi-worked; imitation leather; stout leather; leather used for linings; artificial leather backpacks; artificial leather bags; artificial leather handbags; imitation leather handbags; imitation leather purses; leather cases; leather coin purses; leather handbags; leather purses; leather sling bags for carrying infants; leather suitcases; leather tool bags; leather travelling bags; backpacks for carrying babies; handbags made of precious metal; leather bags; stout leather bags; leather wallets; stout leather wallets; leather boxes; stout leather boxes; leather trunks; stout leather trunks; keycases; trunks [luggage]; suitcases; umbrellas; parasols; sun umbrellas; walking sticks; whips; animal harnesses; saddlery; stirrups; leather straps; saddlery of leather.

Class 25

(2) Trousers; jackets; overcoats; coats; skirts; suits; jerseys; waistcoats; shirts; T-shirts; sweatshirts; dresses; pullovers; jeans; tracksuits; rainwear; bathing suits; clothing for sports; clothing for babies; sports caps; gloves; stockings; camisoles; sarongs; neck scarves; collars for dresses; detachable collars; neckties; ties; shorts; Bermuda shorts; sleepwear; pajamas; baby doll pajamas; beachwear; swim suits; undershirts; sports singlets; underwear; boxer shorts; briefs; boxer briefs; brassieres; panties; pants; thermal underwear; ladies' underwear; children's underwear; women's underwear; men's underwear; knitted underwear; G-strings; body shirts; body shapers; underclothing; body suits; undergarments; suspender belts; socks; muffler scarves; shawls; bandanas; scarves; belts [clothing]; waterproof boots; boots; booties; sports shoes; beach slippers; shoes; slippers; sandals; bridal headpieces; headbands; headscarfs; visors being headwear; hats; caps with visors; berets; caps [headwear]; skull caps.

Claims

Priority Filing Date: November 20, 2019, Country or Office: TURKEY, Application No: 2019/115377
in association with the same kind of goods

Application Number 2,025,144
Language of Application English

Filing Date 2020-04-29

APPLICANT AND AGENT DETAILS

Applicant

CRAYOLA PROPERTIES, INC.
1100 Church Lane
Easton, PA 18044
UNITED STATES OF AMERICA

Agent

GOWLING WLG (CANADA) LLP
SUITE 1600, 1 FIRST CANADIAN PLACE, 100
KING STREET WEST, TORONTO, ONTARIO,
M5X1G5

TRADEMARK DETAILS

COLORS OF THE WORLD

Trademark Type

Standard Characters

Goods

Class 02

(1) paints for arts and crafts

Class 16

(2) colour pencils; colouring books; colouring sets; crayons; marker pens; modeling clay; modeling clay for children; modeling compounds; modelling clay; paint sets

Application Number 2,025,317
International Registration Number 1527562
Language of Application English

Filing Date 2020-02-04

APPLICANT AND AGENT DETAILS

Applicant

Clariss International Inc.
One Apple Park Way
Cupertino CA 95014
UNITED STATES OF AMERICA

Agent

BAKER & MCKENZIE LLP
BROOKFIELD PLACE, 181 BAY STREET,
SUITE 2100, P.O. BOX 874, TORONTO,
ONTARIO, M5J2T3

TRADEMARK DETAILS

CLARIS ENGAGE

Trademark Type

Standard Characters

Services

Class 35

Arranging and conducting trade show exhibitions in the field of computer software; organization of commercial exhibitions, namely, trade fairs and trade shows in the field of computer software and information technology, namely, information technology (IT) systems and communication technology comprised of computer hardware, mobile devices, computer networks, and computer software; organizing and conducting trade show exhibitions in the field of computer software and information technology, namely, information technology (IT) systems and communication technology comprised of computer hardware, mobile devices, computer networks, and computer software, for business purposes

Claims

Priority Filing Date: August 05, 2019, Country or Office: JAMAICA, Application No: 78346 in association with the same kind of services

Application Number 2,025,402
International Registration Number 1527459
Language of Application French

Filing Date 2020-03-10

APPLICANT AND AGENT DETAILS

Applicant

TRIBVN HEALTHCARE
39 rue Louveau
F-92320 Châtillon
FRANCE

Agent

ROBIC
630, boul. René-Lévesque Ouest, 20e étage,
Montréal, QUÉBEC, H3B1S6

TRADEMARK DETAILS

Trademark Type

Design

Visual Representation



Colour Claim

Colour is claimed as a feature of the trademark. The letters SO are blue, and the letters SLIDE are red. The pixelated arrow symbol features a left-to-right gradient going from blue to red.

Goods

Class 09

Software in the nature of medical software for the management, analysis, processing and sharing of medical data; software for the management, analysis, processing and sharing of medical images; software for recognizing patterns, viewing images, transmitting files, searching databases and highlighting images.

Claims

Priority Filing Date: November 18, 2019, Country or Office: FRANCE, Application No: 4599701 in association with the same kind of goods

Application Number 2,025,479
International Registration Number 1527841
Language of Application English

Filing Date 2020-03-23

APPLICANT DETAILS

Applicant

McPherson's Limited
105 Vanessa Street
Kingsgrove NSW 2208
AUSTRALIA

TRADEMARK DETAILS

HAPPY FLORA

Trademark Type

Standard Characters

Goods

Class 05

(1) Laxatives; dietary nutritional supplements to aid digestion; nutritional supplements for humans to aid digestion; probiotic preparations for medical purposes to help maintain a natural balance of flora in the digestive system; probiotic supplements.

(2) Cultures of microorganisms for medical use to help maintain a natural balance of flora in the digestive system; dietary supplements to aid digestion; dietetic beverages adapted for medical purposes to help maintain a natural balance of flora in the digestive system; dietetic confectionery adapted for medical purposes to help maintain a natural balance of flora in the digestive system; dietetic drinks adapted for medical purposes to help maintain a natural balance of flora in the digestive system; dietetic food supplements adapted for medical purposes to help maintain a natural balance of flora in the digestive system; dietetic foods adapted for infants to help maintain a natural balance of flora in the digestive system; dietetic foods adapted for invalids to help maintain a natural balance of flora in the digestive system; dietetic foods adapted for medical purposes to help maintain a natural balance of flora in the digestive system; dietetic foods for medicinal purposes to help maintain a natural balance of flora in the digestive system; dietetic foods for use in clinical nutrition to help maintain a natural balance of flora in the digestive system; dietetic foodstuffs for medical purposes to help maintain a natural balance of flora in the digestive system; dietetic infusions for medical use to help maintain a natural balance of flora in the digestive system; dietetic preparations adapted for medical use to help maintain a natural balance of flora in the digestive system; dietetic substances adapted for medical use to help maintain a natural balance of flora in the digestive system; dietetic substances for babies to help maintain a natural balance of flora in the digestive system; dietetic substances for infants to help maintain a natural balance of flora in the digestive system; dietetic medical foods for invalids to help maintain a natural balance of flora in the digestive system; dietetic substances for medical use to help maintain a natural balance of flora in the digestive system; dietetic substances for medicinal purposes to help maintain a natural balance of flora in the digestive system; digestants to help maintain a natural balance of flora in the digestive system; digestive enzymes to help maintain a natural balance of flora in the digestive system; food supplements to help maintain a natural

balance of flora in the digestive system; nutriments to help maintain a natural balance of flora in the digestive system; nutritional drinks being dietary food supplements to help maintain a natural balance of flora in the digestive system; plant extracts for use as dietary supplements to help maintain a natural balance of flora in the digestive system; protein supplements for humans to help maintain a natural balance of flora in the digestive system.

Claims

Priority Filing Date: November 28, 2019, Country or Office: AUSTRALIA, Application No: 2054259 in association with the same kind of goods (1); February 18, 2020, Country or Office: AUSTRALIA, Application No: 2069877 in association with the same kind of goods (2)

Application Number 2,026,870
International Registration Number 1529574
Language of Application English

Filing Date 2020-04-06

APPLICANT AND AGENT DETAILS

Applicant

Progenics Pharmaceuticals, Inc.
47th Floor Suite J,
One World Trade Center
New York NY 10007
UNITED STATES OF AMERICA

Agent

ANDREA FRIEDMAN-RUSH
(BLANEY MCMURTRY LLP), 2 Queen Street
East, Suite 1500, Toronto, ONTARIO, M5C3G5

TRADEMARK DETAILS

PYLVISMA

Trademark Type

Standard Characters

Goods

Class 05

Radiopharmaceutical imaging and detection agents for detection, diagnosing and monitoring cancer; pharmaceutical preparations for the detection, diagnosis, prevention, treatment and monitoring of cancer.

Services

Class 42

(1) Scientific research and development in the nature of research, development and preparation of pharmaceutical drugs and imaging agents for medical use; providing temporary use of non-downloadable medical imaging software for the identification, quantification, diagnosis, prevention, treatment and monitoring of cancer.

Class 44

(2) Providing medical testing services and information in the field of cancer diagnosis, treatment and prevention; providing medical information in the field of cancer identification, diagnosis, treatment and prevention; medical imaging services.

Claims

Priority Filing Date: October 08, 2019, Country or Office: UNITED STATES OF AMERICA, Application No: 88647025 in association with the same kind of goods and in association with the same kind of services

Application Number 2,026,872
International Registration Number 1528601
Language of Application English

Filing Date 2020-04-06

APPLICANT AND AGENT DETAILS

Applicant

Progenics Pharmaceuticals, Inc.
47th Floor Suite J
One World Trade Center
New York NY 10007
UNITED STATES OF AMERICA

Agent

ANDREA FRIEDMAN-RUSH
(BLANEY MCMURTRY LLP), 2 Queen Street
East, Suite 1500, Toronto, ONTARIO, M5C3G5

TRADEMARK DETAILS

PYLSCAN

Trademark Type

Standard Characters

Goods

Class 05

Radiopharmaceutical imaging and detection agents for detection, diagnosing and monitoring cancer; pharmaceutical preparations for the detection, diagnosis, prevention, treatment and monitoring of cancer.

Services

Class 42

(1) Scientific research and development in the nature of research, development and preparation of pharmaceutical drugs and imaging agents for medical use; providing temporary use of non-downloadable medical imaging software for the identification, quantification, diagnosis, prevention, treatment and monitoring of cancer.

Class 44

(2) Providing medical testing services and information in the field of cancer diagnosis, treatment and prevention; providing medical information in the field of cancer identification, diagnosis, treatment and prevention; medical imaging services.

Claims

Priority Filing Date: October 08, 2019, Country or Office: UNITED STATES OF AMERICA, Application No: 88647007 in association with the same kind of goods and in association with the same kind of services

Application Number 2,026,876
International Registration Number 1529733
Language of Application English

Filing Date 2020-04-06

APPLICANT AND AGENT DETAILS

Applicant

Progenics Pharmaceuticals, Inc.
47th Floor Suite J,
One World Trade Center
New York NY 10007
UNITED STATES OF AMERICA

Agent

ANDREA FRIEDMAN-RUSH
(BLANEY MCMURTRY LLP), 2 Queen Street
East, Suite 1500, Toronto, ONTARIO, M5C3G5

TRADEMARK DETAILS

PYLARIFY

Trademark Type

Standard Characters

Goods

Class 05

Radiopharmaceutical imaging and detection agents for detection, diagnosing and monitoring cancer; pharmaceutical preparations for the detection, diagnosis, prevention, treatment and monitoring of cancer.

Services

Class 42

(1) Scientific research and development in the nature of research, development and preparation of pharmaceutical drugs and imaging agents for medical use; Providing temporary use of non-downloadable medical imaging software for the identification, quantification, diagnosis, prevention, treatment and monitoring of cancer.

Class 44

(2) Providing medical testing services and information in the field of cancer diagnosis, treatment and prevention; providing medical information in the field of cancer identification, diagnosis, treatment and prevention; medical imaging services.

Claims

Priority Filing Date: October 08, 2019, Country or Office: UNITED STATES OF AMERICA, Application No: 88647018 in association with the same kind of goods and in association with the same kind of services

Application Number 2,026,996
Language of Application English

Filing Date 2020-05-07

APPLICANT DETAILS

Applicant

Milayne Van Der Weyde
810 arlington ave
PO box 407
Slocan
BRITISH COLUMBIA
V0G2C0

TRADEMARK DETAILS

Trademark Type

Design

Visual Representation



Goods

Class 16

(1) adhesive corners for photographs; adhesive labels; adhesive note pads; adhesive note paper; bumper stickers; sticker albums; stickers; vehicle bumper stickers

Class 18

(2) all purpose sport bags; all-purpose athletic bags; all-purpose carrying bags; all-purpose sports bags; animal identification collars; animal leashes; athletic bags; baby carrying bags; backpacks, book bags, sports bags, bum bags, wallets and handbags; bags for sports clothing; beach bags; belt bags and hip bags; cat collars; children's shoulder bags; clothing for domestic pets; clothing for pets; cosmetic bags sold empty; dog leashes; hip bags; leashes for animals; leashes for pets; leather bags; leather bags and wallets; pet leashes; shopping bags; small bags for men; souvenir bags; travel bags

Class 20

(3) decorative pillows; pillows

Class 21

(4) cardboard cups; coffee cups; compostable and biodegradable plates, bowls, cups and trays; compostable cups; cups; cups and mugs; drinking cups

Class 24

(5) adhesive fabric for application by heat; baby blankets; bed blankets; bed blankets made of man-made fibres; blankets; blankets for babies; children's pillow cases; pillow cases; pillow covers

Class 25

(6) A-shirts; adhesive bras; adhesive brassieres; adult sweatpants; athletic clothing; baby clothes; baby clothing; baby layettes for clothing; baseball caps and hats; beach clothes; belts; button down shirts; casual shirts; children's shirts; collared shirts; dress shirts; fashion hats; fitted swimming costumes with bra cups; fleece shirts; hats; long sleeve shirts; long-sleeved t-shirts; men's shirts; mock turtleneck shirts; muscle shirts; open-necked shirts; shirt fronts; short-sleeve shirts; short-sleeved shirts; sweat shirts; sweaters; sweatshirts; t-shirts; tee-shirts; turtleneck sweaters; women's shirts

Class 26

(7) belt buckles; belt buckles for clothing; belt buckles of precious metal for clothing; charms for cat collars; charms for dog collars; charms for pet collars

Application Number 2,027,793
Language of Application English

Filing Date 2020-05-13

APPLICANT AND AGENT DETAILS

Applicant

Intelligent Cleaning Equipment Holdings Co.
Ltd.
OMC Chambers
Wickhams Cay 1, Road Town
Tortola,
VIRGIN ISLANDS (BRITISH)

Agent

GOWLING WLG (CANADA) LLP
SUITE 1600, 1 FIRST CANADIAN PLACE, 100
KING STREET WEST, TORONTO, ONTARIO,
M5X1G5

TRADEMARK DETAILS

ICE ROBOTICS

Trademark Type

Standard Characters

Goods

Class 07

floor cleaning machines; industrial robots for cleaning floors;

Application Number 2,027,794
Language of Application English

Filing Date 2020-05-13

APPLICANT AND AGENT DETAILS

Applicant

Intelligent Cleaning Equipment Holdings Co.
Ltd.
OMC Chambers
Wickhams Cay 1, Road Town
Tortola,
VIRGIN ISLANDS (BRITISH)

Agent

GOWLING WLG (CANADA) LLP
SUITE 1600, 1 FIRST CANADIAN PLACE, 100
KING STREET WEST, TORONTO, ONTARIO,
M5X1G5

TRADEMARK DETAILS

ICE COBOTICS

Trademark Type

Standard Characters

Goods

Class 07

floor cleaning machines; industrial robots for cleaning floors;

Application Number 2,028,222
International Registration Number 1530720
Language of Application English

Filing Date 2020-04-06

APPLICANT AND AGENT DETAILS

Applicant

Progenics Pharmaceuticals, Inc.
47th Floor Suite J,
One World Trade Center
New York NY 10007
UNITED STATES OF AMERICA

Agent

ANDREA FRIEDMAN-RUSH
(BLANEY MCMURTRY LLP), 2 Queen Street
East, Suite 1500, Toronto, ONTARIO, M5C3G5

TRADEMARK DETAILS

PYLMARKER

Trademark Type

Standard Characters

Goods

Class 05

Radiopharmaceutical imaging and detection agents for detection, diagnosing and monitoring cancer; pharmaceutical preparations for the detection, diagnosis, prevention, treatment and monitoring of cancer.

Services

Class 42

(1) Scientific research and development in the nature of research, development and preparation of pharmaceutical drugs and imaging agents for medical use; providing temporary use of non-downloadable medical imaging software for the identification, quantification, diagnosis, prevention, treatment and monitoring of cancer.

Class 44

(2) Providing medical testing services and information in the field of cancer diagnosis, treatment and prevention; providing medical information in the field of cancer identification, diagnosis, treatment and prevention; medical imaging services.

Claims

Priority Filing Date: October 08, 2019, Country or Office: UNITED STATES OF AMERICA, Application No: 88647029 in association with the same kind of goods and in association with the same kind of services

Application Number 2,028,223
International Registration Number 1530647
Language of Application English

Filing Date 2020-04-06

APPLICANT AND AGENT DETAILS

Applicant

Progenics Pharmaceuticals, Inc.
47th Floor Suite J,
One World Trade Center
New York NY 10007
UNITED STATES OF AMERICA

Agent

ANDREA FRIEDMAN-RUSH
(BLANEY MCMURTRY LLP), 2 Queen Street
East, Suite 1500, Toronto, ONTARIO, M5C3G5

TRADEMARK DETAILS

PYLVUE

Trademark Type

Standard Characters

Goods

Class 05

Radiopharmaceutical imaging and detection agents for detection, diagnosing and monitoring cancer; pharmaceutical preparations for the detection, diagnosis, prevention, treatment and monitoring of cancer.

Services

Class 42

(1) Scientific research and development in the nature of research, development and preparation of pharmaceutical drugs and imaging agents for medical use; providing temporary use of non-downloadable medical imaging software for the identification, quantification, diagnosis, prevention, treatment and monitoring of cancer.

Class 44

(2) Providing medical testing services and information in the field of cancer diagnosis, treatment and prevention; providing medical information in the field of cancer identification, diagnosis, treatment and prevention; medical imaging services.

Claims

Priority Filing Date: October 08, 2019, Country or Office: UNITED STATES OF AMERICA, Application No: 88647011 in association with the same kind of goods and in association with the same kind of services

Application Number 2,028,539
Language of Application English

Filing Date 2020-05-14

APPLICANT AND AGENT DETAILS

Applicant

MAG CANADA BEVERAGE LTD.
Unit 100 - 565 Great Northern Way
Vancouver
BRITISH COLUMBIA
V5T0H8

Agent

ACCUPRO TRADEMARK SERVICES LLP
SUITE 702 - 401 WEST GEORGIA STREET,
VANCOUVER, BRITISH COLUMBIA, V6B5A1

TRADEMARK DETAILS

WHITE CLAW MADE WITHOUT COMPROMISE

Trademark Type

Standard Characters

Goods

Class 32

(1) ale; beer; beer-based cocktails; flavoured beers; lager; porter; stout;

Class 33

(2) alcoholic cocktails; alcoholic cocktails in the form of chilled gelatins; alcoholic coolers; alcoholic fruit drinks; alcoholic lemonade; alcoholic malt-based coolers; alcoholic punches; alcoholic seltzer; hard seltzer; vodka seltzer;

Application Number 2,029,291
Language of Application English

Filing Date 2020-05-20

APPLICANT AND AGENT DETAILS

Applicant

Jilfinity and Beyond, LLC
c/o Grant Tani Barash & Altman, LLC
9100 Wilshire Blvd., Suite 1000W
Beverly Hills, CA 90212
UNITED STATES OF AMERICA

Agent

BORDEN LADNER GERVAIS LLP
World Exchange Plaza, 100 Queen Street,
Suite 1300, Ottawa, ONTARIO, K1P1J9

TRADEMARK DETAILS

FLYK TRICK

Trademark Type

Standard Characters

Goods

Class 03

mascara

Application Number 2,029,465
International Registration Number 1531880
Language of Application English

Filing Date 2020-01-27

APPLICANT AND AGENT DETAILS

Applicant

Biogena Naturprodukte GmbH & Co KG
Strubergasse 24
A-5020 Salzburg
AUSTRIA

Agent

KIRBY EADES GALE BAKER
100 Murray Street, Suite 500, Ottawa,
ONTARIO, K1N0A1

TRADEMARK DETAILS

OPC POLYMAX Formula

Trademark Type

Standard Characters

Goods

Class 05

Pharmaceutical and veterinary preparations, namely nutraceuticals for use as a dietary supplement, namely, amino acids, anti-oxidants, dietary fiber, trace elements, vitamins, minerals, minerals and trace elements, cannabis derivatives, omega-3 fatty acids, hemp-based, wheat-based, prebiotics, probiotics, synbiotic supplements, algae, medicinal mushrooms, intestinal bacteria, folic acid, ground flaxseed fibre, lecithin, linseed, pine pollen, whey protein, protein powder, red wine powder, royal jelly, soy isoflavone, spirulina, dietary yeast, wheatgrass, fish oil, Coenzyme Q10, grape seed, green tea extracts, pomegranate extracts, pumpkin extracts, cranberry extracts, olive leaf, yam extracts, maca, saw palmetto, rosemary, ashwagandha; pharmaceutical and veterinary preparations, namely nutraceuticals for use as a dietary supplement for general health and well-being, for promotion of healthy liver function, for use in oncology, for brain development, for building body mass, for promoting weight loss, for body weight control, for infant and child health and well-being, for prenatal and postnatal health and well-being, for controlling and managing cholesterol, for colon detoxification, for liver detoxification, for boosting energy, for improving fertility, for stress management, for promoting intestinal health and balance, for improving circulation, and for improving metabolism; pharmaceutical and veterinary preparations, namely nutraceuticals for use as a dietary supplement, namely, for the treatment of arthritis, cancer, cardiovascular diseases, dental and oral diseases, headaches, PMS, infectious diseases, namely, urinary tract infections, inflammatory diseases, namely inflammatory bowel diseases and inflammatory connective tissue diseases, musculoskeletal system, namely, connective tissue diseases, cartilage injuries, respiratory system, dermatology, namely, dermatitis, eczema, psoriasis; sanitary preparations for medical purposes, namely, sanitary pads, sanitary tampons, sanitary towels, antiseptic cleaning preparations, cleaning preparations for contact lenses, gastrointestinal cleaning agents, medicated cleansers for skin and wounds, medicated dental cleaning gels, mouth cavity cleansers, and preparations for cleansing the skin for medical purposes; dietetic food and substances adapted for medical and veterinary use, in particular dietetic products for a balanced diet for medical and veterinary use, namely, meal replacement bars, nutritional supplement meal replacement beverages containing vitamins and minerals,

nutritional supplement meal replacement powders containing vitamins and minerals, dietary food supplements in the nature of ready-to-eat protein bars for medical purposes, dietary supplement drink mixes for promoting a balanced diet and for general health and wellbeing, feed additives for veterinary preparations, feed supplements for veterinary purposes, and nutritional supplements for animal feed; starch for dietetic purposes, starch for pharmaceutical purposes; food for babies in particular powdered milk for babies; dietary supplements for humans and animals for medical purposes, in particular antioxidants for humans and animals for medical purposes; nutritional supplements and dietetic food supplements for sports and performance enhancement, adapted for medical use; meal replacement powders for sports and performance enhancement for medical use; mineral food supplements, consisting primarily of vitamins, amino acids, minerals and trace elements, adapted for medical purposes; vitamin preparations; preparations for making medicated dietetic beverages, namely, vitamin supplements in tablet form for making effervescent beverages when added to water; preparations for making medicated dietetic beverages, namely, syrups and herbal flavourings and nutraceutical additives for making medicated dietetic beverages for general health and well-being, for promotion of healthy liver function, for use in oncology, for brain development, for building body mass, for promoting weight loss, for body weight control, for infant and child health and well-being, for prenatal and postnatal health and well-being, for controlling and managing cholesterol, for colon detoxification, for liver detoxification, for boosting energy, for improving fertility, for stress management, for promoting intestinal health and balance, for improving circulation, and for improving metabolism, for the treatment of arthritis, cancer, cardiovascular diseases, dental and oral diseases, headaches, PMS, infectious diseases, namely, urinary tract infections, inflammatory diseases, namely inflammatory bowel diseases and inflammatory connective tissue diseases, musculoskeletal system, namely, connective tissue diseases, cartilage injuries, respiratory system, dermatology, namely, dermatitis, eczema, psoriasis; drinks for medical purposes, namely herbal teas and beverages containing amino acids, antioxidants, dietary fiber, trace elements, vitamins, minerals, amino acids, minerals and trace elements, cannabis derivatives, omega-3 fatty acids, hemp-based, wheat-based, prebiotics, probiotics, synbiotic supplements, algae, medicinal mushrooms, intestinal bacteria, folic acid, ground flaxseed fibre, lecithin, linseed, pine pollen, whey protein, protein powder, red wine powder, royal jelly, soy isoflavone, spirulina, dietary yeast, wheatgrass, fish oil, Coenzyme Q10, grape seed, green tea extracts, pomegranate extracts, pumpkin extracts, cranberry extracts, olive leaf, yam extracts, maca, saw palmetto, rosemary, ashwagandha; drinks for medical purposes, namely, herbal teas and beverages for general health and well-being, for promotion of healthy liver function, for use in oncology, for brain development, for building body mass, for promoting weight loss, for body weight control, for infant and child health and well-being, for prenatal and postnatal health and well-being, for controlling and managing cholesterol, for colon detoxification, for liver detoxification, for boosting energy, for improving fertility, for stress management, for promoting intestinal health and balance, for improving circulation, and for improving metabolism; drinks for medical purposes, namely, herbal teas for the treatment of arthritis, cancer, cardiovascular diseases, dental and oral diseases, headaches, PMS, infectious diseases, namely, urinary tract infections, inflammatory diseases, namely inflammatory bowel diseases and inflammatory connective tissue diseases, musculoskeletal system, namely, connective tissue diseases, cartilage injuries, respiratory system, dermatology, namely, dermatitis, eczema, psoriasis; medical plasters; surgical dressings; material for dental fillings and dental impressions; all-purpose disinfectants; preparations for destroying noxious animals; fungicides, herbicides.

Claims

Priority Filing Date: July 26, 2019, Country or Office: AUSTRIA, Application No: AM 11448/2019 in association with the same kind of goods

Application Number 2,029,734
International Registration Number 1531771
Language of Application English

Filing Date 2020-04-27

APPLICANT AND AGENT DETAILS

Applicant

BLACKCAT TIRE (FUJIAN) CO.,LTD
No.1 Dangan Road,
Dingban Village, Xiyuan Town,
Zhangping City
364413 Fujian Province
CHINA

Agent

MILTONS IP/P.I.
15 Fitzgerald Rd, Suite 200, Ottawa,
ONTARIO, K2H9G1

TRADEMARK DETAILS

Trademark Type

Design

Visual Representation



BLACK CAT

Goods

Class 12

Outer tube of pneumatic tyre; inner tubes for cycle tires; airplane tyre; bicycle inner tube.

Application Number 2,029,780
Language of Application English

Filing Date 2020-05-20

APPLICANT AND AGENT DETAILS

Applicant

Globe Union Industrial Corp.
22, Chien-Kuo Rd.
Taichung Export Processing Zone,
TAIWAN

Agent

MARKS & CLERK
33 Yonge Street, , Suite 300, Toronto,
ONTARIO, M5E1G4

TRADEMARK DETAILS

Trademark Type

Design

Visual Representation



**DROP
& TWIST**

Goods

Class 11

faucets

Application Number 2,030,321
Language of Application English

Filing Date 2020-05-25

APPLICANT AND AGENT DETAILS

Applicant

Harry Leung-Kit SIU
1308-197 Yonge St
Toronto
ONTARIO
M5B1M4

Agent

BLANEY MCMURTRY LLP
Suite 1500, 2 Queen Street East, Toronto,
ONTARIO, M5C3G5

TRADEMARK DETAILS

ANJIA

Trademark Type

Standard Characters

Services

Class 36

(1) real estate agencies; real estate brokers; real estate investment; real estate management

Class 37

(2) advisory services relating to the construction of buildings; building construction contracting services; building construction services; construction and renovation of buildings; construction of residential and commercial properties; development of residential and commercial properties; home renovation; land development; project management in the field of building construction; real estate development

Application Number 2,030,367
Language of Application English

Filing Date 2020-05-25

APPLICANT AND AGENT DETAILS

Applicant

WOLKENKRAFT LIMITED
RM B10 BLK1 13/F YIP FAT FACTORY
BUILDING
NO.77 HOI YUEN ROAD
KWUN TONG KL,
HONG KONG

Agent

MILTONS IP/P.I.
15 Fitzgerald Rd, Suite 200, Ottawa,
ONTARIO, K2H9G1

TRADEMARK DETAILS

wolkenkraft

Trademark Type

Standard Characters

Services

Class 35

advice in the running of establishments as franchises; business information services in the field of stock prices; business management services relating to information and data compiling and analyzing; design of marketing surveys; dissemination of advertising matter for others; distribution of handbills; import-export agency services; marketing research; media relations services; negotiation of business contracts for others; on-line advertising the goods and services of others on computer communications networks; on-line trading services in which seller posts products to be auctioned and bidding is done via the Internet; organisation of fashion shows for commercial purposes; providing market intelligence services; provision of space on websites for advertising goods and services; retail services for pharmaceutical, veterinary and sanitary preparations and medical supplies; search engine optimization; statistical analysis and reporting services for business purposes; wholesale services for pharmaceutical, veterinary and sanitary preparations and medical supplies

Application Number 2,030,757
International Registration Number 1532456
Language of Application English

Filing Date 2020-01-13

APPLICANT AND AGENT DETAILS

Applicant

Splashlight Holding LLC
75 Varick Street
New York NY 10013
UNITED STATES OF AMERICA

Agent

DENTONS CANADA LLP
99 BANK STREET, SUITE 1420, OTTAWA,
ONTARIO, K1P1H4

TRADEMARK DETAILS

LiiV

Trademark Type

Standard Characters

Goods

Class 09

Downloadable software for data analysis in the nature of analytical services relating to consumer behavior through analysis of data files, image files and metadata associated with such data files; downloadable software for information management, namely, collection and compilation of information from computer databases in the field of data analytics; downloadable software for analyzing images and image files for the purposes of determining consumer behaviour on the basis of individual preferences, preferences attributed to ethnic groups, demographic areas, social groups, political groups, geographic locations, religious groups, economic groups.

Services

Class 35

(1) Business data analysis for others in the nature of analytical services relating to consumer behavior through analysis of data files, image files and metadata associated with such data files; business data analysis of images and image files for others for the purposes of determining consumer behaviour on the basis of individual preferences, preferences attributed to ethnic groups, demographic areas, social groups, political groups, geographic locations, religious groups, economic groups; information management for others, namely, collection and compilation of information from computer databases in the field of data analytics.

Class 42

(2) Providing online non-downloadable software for data analysis in the nature of analytical services relating to consumer behavior through analysis of data files, image files and metadata associated with such data files; providing online non-downloadable software for information management, namely, collection and compilation of information from computer databases in the field of data analytics; providing online nondownloadable software for analyzing images and image files for the purposes of determining consumer behaviour on the basis of individual preferences, preferences attributed to ethnic groups, demographic areas, social groups, political groups, geographic locations, religious groups, economic groups; non-downloadable software for technical analysis of images and image files for others for the purposes of determining consumer behaviour

on the basis of individual preferences, preferences attributed to ethnic groups, demographic areas, social groups, political groups, geographic locations, religious groups, economic groups.

Claims

Priority Filing Date: July 12, 2019, Country or Office: UNITED STATES OF AMERICA, Application No: 88511871 in association with the same kind of goods and in association with the same kind of services

Application Number 2,030,758
International Registration Number 1532841
Language of Application English

Filing Date 2020-01-13

APPLICANT AND AGENT DETAILS

Applicant

Splashlight Holding LLC
75 Varick Street
New York NY 10013
UNITED STATES OF AMERICA

Agent

DENTONS CANADA LLP
99 BANK STREET, SUITE 1420, OTTAWA,
ONTARIO, K1P1H4

TRADEMARK DETAILS

ETHNO.AI

Trademark Type

Standard Characters

Goods

Class 09

Downloadable software for analytical services relating to consumer behavior through analysis of business data files, image files and metadata associated with such business consumer data files; downloadable software for information management, namely, collection and compilation of information from computer databases in the field of data analytics; downloadable software for analyzing images and image files for the purposes of determining consumer behaviour on the basis of individual preferences, preferences attributed to various socio-economic groups, demographic areas, political affiliations, geographic locations.

Services

Class 35

(1) Information management for others, namely, collection and compilation of information from computer databases in the field of data analytics.

Class 42

(2) Providing online non-downloadable software for analytical services relating to consumer behavior through analysis of business data files, image files and metadata associated with such business consumer data files; providing online non-downloadable software for information management, namely, collection and compilation of information from computer databases in the field of data analytics; providing online non-downloadable software for analyzing images and image files for the purposes of determining consumer behaviour on the basis of individual preferences, preferences attributed to various socio-economic groups, demographic areas, political affiliations, geographic locations; non-downloadable software for technical analysis of images and image files for others for the purposes of determining consumer behaviour on the basis of individual preferences, preferences attributed to various socio-economic groups, demographic areas, political affiliations, geographic locations.

Claims

Priority Filing Date: July 12, 2019, Country or Office: UNITED STATES OF AMERICA, Application No: 88512024 in association with the same kind of goods and in association with the same kind of services

Application Number 2,032,109
Language of Application English

Filing Date 2020-06-04

APPLICANT AND AGENT DETAILS

Applicant

The University of Pittsburgh - Of the
Commonwealth System of Higher Education
2400 Cathedral of Learning
4200 Fifth Avenue
Pittsburgh, PA 15260
UNITED STATES OF AMERICA

Agent

BORDEN LADNER GERVAIS LLP
World Exchange Plaza, 100 Queen Street,
Suite 1300, Ottawa, ONTARIO, K1P1J9

TRADEMARK DETAILS

P2S

Trademark Type

Standard Characters

Goods

Class 10

Syringes for medical purposes

Claims

Priority Filing Date: December 12, 2019, Country or Office: UNITED STATES OF AMERICA,
Application No: 88/724,750 in association with the same kind of goods

Application Number 2,032,179
Language of Application English

Filing Date 2020-06-05

APPLICANT DETAILS

Applicant

Shenzhen Douding Technology Co., Ltd.
201, BLDG 12, No.3 Industrial Zone, Longfeng
1st Rd, Longyuan Community
Longhua St., Longhua Dist.
Shenzhen,
CHINA

TRADEMARK DETAILS

Trademark Type

Design

Visual Representation

Goods

Class 07

Aquarium pumps; Aerating pumps for aquaria; Net hauling machines; Shearing machines for animals; Disintegrators for chemical processing; Incubators for eggs; Milking machines; Vacuum cleaners; Mechanized livestock feeders

Application Number 2,032,754
Language of Application English

Filing Date 2020-06-05

APPLICANT DETAILS

Applicant

Shenzhen Douding Technology Co., Ltd.
201, BLDG 12, No.3 Industrial Zone, Longfeng
1st Rd, Longyuan Community
Longhua St., Longhua Dist.
Shenzhen,
CHINA

TRADEMARK DETAILS

Trademark Type

Design

Visual Representation

Goods

Class 07

Aquarium pumps; Aerating pumps for aquaria; Net hauling machines; Shearing machines for animals; Disintegrators for chemical processing; Incubators for eggs; Milking machines; Vacuum cleaners; Mechanized livestock feeders

Application Number 2,033,303
International Registration Number 1535356
Language of Application English

Filing Date 2020-01-14

APPLICANT AND AGENT DETAILS

Applicant

AVB UG (haftungsbeschränkt)
Sudenburger Wuhne 61
39116 Magdeburg
GERMANY

Agent

JULIE LAROUCHE
(CABINET JURIDIQUE ST-LAWRENCE S.E.N.
C.R.L.), 2301, Saint-Patrick Street, Suite B6,
Montreal, QUEBEC, H3K1B3

TRADEMARK DETAILS

Trademark Type

Design

Visual Representation



Goods

Class 18

(1) Leather and imitations of leather, and goods made of these materials, namely bags, leisure bags, travelling bags, shopping bags, cross-body bags, shoulder bags, handbags, evening bags, briefcases, sports bags, beach bags, school bags, shoulder straps, children's bags, cosmetic bags, belt bags, suitcases, vanity cases, hat boxes, attaché cases, brief bags, garment bags, backpacks, pouches, neck pouches, toilet bags, travelling sets, stocking bags, shoe bags, sports bags, school satchels, small leather goods, namely card cases [notecases], identity card cases, wallets, key cases; luggage trunks; travelling bags; attaché cases; beach bags; wallets; bags for campers; document cases; shopping bags; purses; suitcases; handbags; hip bags and belt bags; animal skins and hides; card cases [notecases incorporating card holders]; cases of leather or leatherboard; sling bags for carrying infants; toiletry bags and wash bags; rucksacks; school bags; satchels; shoe bags; boxes of leather or leatherboard; garment bags for travel; vanity cases, not fitted; music cases; bags [envelopes, pouches] of leather, for packaging; umbrellas and parasols; walking sticks; canes; umbrella sticks; umbrella covers; whips, harness and saddlery; key cases [leatherware]; sports bags and training bags; tool bags of leather, empty; shaped waterproof covers specifically adapted to protect backpacks, bags, document cases, trunks and suitcases from the rain.

Class 25

(2) Clothing, namely casual clothing, business clothing, children's clothing, dress clothing, athletic clothing, underwear, outdoor winter clothing, hosiery, shawls, gloves, mittens, scarves, and sleepwear; footwear, namely shoes, boots, sandals, and slippers; headwear, namely caps, hats, sweatbands, head wraps, headbands, bandanas, scarves, toques, earmuffs, skull caps, berets, and balaclavas; suits; visors; layettes [clothing]; bathing suits, bathing trunks, bath robes, bathing caps, bath slippers; bikinis; gaiters, namely, neck gaiters, leg gaiters and ankle gaiters; belts

[clothing]; clothing for gymnastics; gymnastic shoes; neckerchiefs; gloves [clothing]; shirts and/or shirt-blouses; trousers, included in this class; hats; jackets [clothing]; parkas; anoraks; hoods [clothing]; neckties; ascots; bibs, not of paper; leggings; coats; outerwear, namely, ponchos, coats, jackets, vests, and parkas; combination suits for men; sweaters; cyclists' clothing; raincoats, rain capes, rain ponchos; skirts; neck scarves [mufflers]; pyjamas; shoes, included in this class; aprons; socks; boots for sports, included in this class; beach clothes; stockings; tights; knitwear, namely, pullovers, sweaters, cardigans, jackets; T-shirts; underwear; girdles.

Claims

Priority Filing Date: July 23, 2019, Country or Office: GERMANY, Application No: 30 2019 109 586 in association with the same kind of goods

Application Number 2,033,515
International Registration Number 1535030
Language of Application English

Filing Date 2020-04-22

APPLICANT DETAILS

Applicant

Sitemate Technologies IP Pty Ltd
Level 3, 11 York Street
Sydney NSW 2000
AUSTRALIA

TRADEMARK DETAILS

SITEMATE

Trademark Type

Standard Characters

Goods

Class 09

Computer programs for project management; computer software for project management; downloadable mobile phone software applications for project management; computer software downloaded from the internet for project management; computer software programs for project management; downloadable software applications (apps) for project management; mobile applications for project management; smartphone software applications, downloadable for project management.

Services

Class 42

Computer software consultancy; consulting services in the field of software as a service (saas); computer software design; computer software development; computer software engineering; computer software programming services; computer software technical support services; computer technical support services, namely, troubleshooting in the nature of diagnosing computer hardware and software problems; design of computer software; development of computer software; computer software development in the field of mobile applications; consulting in the field of cloud computing networks and applications; development of software; software as a service (SAAS) provider featuring online non-downloadable software for developing, generating and uploading courses of instruction and coaching material in the field of computer software development; software as a service (saas) services featuring online non-downloadable software for use in management of servers; software as a service (SAAS) provider featuring online non-downloadable software for developing, generating and uploading courses of instruction and coaching material in the field of project management for businesses; computer software project management services; consulting in the field of cloud computing networks and applications; providing virtual computer systems and virtual computer environments through cloud computing; cloud computing provider services for general storage of data; cloud computing providing software for database management; cloud computing web hosting services; cloud computing photo sharing services; cloud computing video hosting web sites

Claims

Priority Filing Date: November 15, 2019, Country or Office: AUSTRALIA, Application No: 2051281
in association with the same kind of goods and in association with the same kind of services

Application Number 2,033,525
International Registration Number 1535574
Language of Application English

Filing Date 2020-04-23

APPLICANT DETAILS

Applicant

Sitemate Technologies IP Pty Ltd
Level 3, 11 York Street
Sydney NSW 2000
AUSTRALIA

TRADEMARK DETAILS

DASHPIVOT

Trademark Type

Standard Characters

Goods

Class 09

Computer programs for project management; computer software for project management; downloadable mobile phone software applications for project management; computer software downloaded from the internet for project management; computer software programs for project management; downloadable software applications (apps) for project management; mobile applications for project management; smartphone software applications, downloadable for project management.

Services

Class 42

Computer software consultancy; consulting services in the field of software as a service (saas); computer software design; computer software development; computer software engineering; computer software programming services; computer software technical support services; computer technical support services, namely, troubleshooting in the nature of diagnosing computer hardware and software problems; design of computer software; development of computer software; computer software development in the field of mobile applications; consulting in the field of cloud computing networks and applications; development of software; software as a service (SAAS) provider featuring online non-downloadable software for developing, generating and uploading courses of instruction and coaching material in the field of computer software development; software as a service (saas) services featuring online non-downloadable software for use in management of servers; software as a service (SAAS) provider featuring online non-downloadable software for developing, generating and uploading courses of instruction and coaching material in the field of project management for businesses; computer software project management services; consulting in the field of cloud computing networks and applications; providing virtual computer systems and virtual computer environments through cloud computing; cloud computing provider services for general storage of data; cloud computing providing software for database management; cloud computing web hosting services; cloud computing photo sharing services; cloud computing video hosting web sites

Claims

Priority Filing Date: November 15, 2019, Country or Office: AUSTRALIA, Application No: 2051280
in association with the same kind of goods and in association with the same kind of services

Application Number 2,033,554
International Registration Number 1534852
Language of Application French

Filing Date 2020-04-28

APPLICANT AND AGENT DETAILS

Applicant
FAYOL
2 route de Larnage
F-26600 TAIN L'HERMITAGE
FRANCE

Agent
ROBIC
630, boul. René-Lévesque Ouest, 20e étage,
Montréal, QUÉBEC, H3B1S6

TRADEMARK DETAILS

Trademark Type
Design

Visual Representation



Goods

Class 11

Cooking apparatus, namely pizza ovens, baking ovens, wood burning ovens; constituent parts for wood burning ovens, namely doors.

Claims

Priority Filing Date: February 27, 2020, Country or Office: FRANCE, Application No: 4628066 in association with the same kind of goods

Application Number 2,034,738
International Registration Number 1536654
Language of Application English

Filing Date 2020-03-10

APPLICANT AND AGENT DETAILS

Applicant

Locana, Inc.
3545 John Hopkins Court, Ste. 200
San Diego CA 92121
UNITED STATES OF AMERICA

Agent

DJB
500 Boulevard Gouin E, Suite 302, Montréal,
QUEBEC, H3L3R9

TRADEMARK DETAILS

LOCANA

Trademark Type

Standard Characters

Services

Class 42

Development of new technology in the nature of gene therapies, RNA-targeted gene therapy and genetic medicines that correct dysfunctional messenger RNA and that target RNA dysfunction of severe diseases and products for others in the field of biotechnology, genetics, medical, diagnostic, and pharmaceutical.

Application Number 2,035,016
Language of Application English

Filing Date 2020-06-18

APPLICANT DETAILS

Applicant

Irfan Mayani
41 malaspina close
brampton
ONTARIO
l6y6c8

TRADEMARK DETAILS

karachiXpress

Trademark Type

Standard Characters

Services

Class 39

(1) delivery of food by restaurants

Class 43

(2) bar and restaurant services; business catering services; cafe-restaurants; cafés; carry-out restaurant services; carry-out restaurants; catering for the provision of food and beverages; catering in fast-food cafeterias; catering of food and drinks; catering services; catering services for company cafeterias

Application Number 2,035,685
Language of Application English

Filing Date 2020-06-23

APPLICANT DETAILS

Applicant

Phytoconfluence Labs Inc.
5307 victoria drive
410
Vancouver
BRITISH COLUMBIA
V5P3V6

TRADEMARK DETAILS

Thuja Wellness

Trademark Type

Standard Characters

Services

Class 44

acupuncture services; chiropractic services; chiropractic services for adults; consultancy in the field of nutrition; consultancy relating to nutrition; consultancy services in the field of nutrition; counselling relating to holistic psychology and occupational therapy; counselling relating to occupational therapy; deep tissue massage; fertility treatment; food and nutrition consultation services; health care consultancy in the field of occupational therapy; health spa services for health and wellness of the body and spirit; holistic massage therapy services; hot stone massage services; human fertility treatment services; individual and group psychology services; information in the field of massage; massage; massage and therapeutic shiatsu massage; massage services; medical clinic services; medical counselling relating to stress; medical examination services; midwife services; moxibustion; moxibustion therapy; music therapy for physical, psychological and cognitive purposes; music therapy services; nutrition consultancy; nutrition counseling; nutritional advice; nutritional advisory services; nutritional counselling in the field of herbology; occupational therapy; occupational therapy and rehabilitation services; occupational therapy services; operation of a wellness centre providing acupuncture services; osteopathy services; physical examination services; physical rehabilitation; physical therapy services; physiotherapy; physiotherapy services; providing breastfeeding information; providing information about dietary supplements and nutrition; providing information in the field of nutrition via a website; providing information in the field of psychological counseling and treatment; providing information pertaining to massage; providing information relating to acupuncture; providing information relating to chiropractic; providing information relating to dietary and nutritional guidance; providing information relating to dietary and nutritional supplements; providing information relating to massage; providing information relating to moxibustion; providing information relating to physical examinations; providing information relating to the treatment of dislocated joints, sprains or bone fractures; providing medical advice in the field of weight loss; providing medical information in the field of weight loss; providing nutritional information about drinks for medical weight loss purposes; providing nutritional information about food for medical weight loss purposes; providing weight loss program services; providing weight loss programme services; psychological care services; psychological consultation; psychological

consultations; psychological counseling services; psychological counselling of staff; psychotherapy; psychotherapy services; public health counselling; reflexology services; reiki healing services; reiki therapy services; shiatsu massage; sports massage services; sports medicine services; stress management services in the field of energy balancing; Thai massage services; traditional Japanese massage; traditional Japanese massage services

Application Number 2,035,938
Language of Application English

Filing Date 2020-06-24

APPLICANT DETAILS

Applicant

Kensary Inc.
315 Eglinton Ave W
Suite 202
Toronto
ONTARIO
M5N1A1

TRADEMARK DETAILS

The Kensary

Trademark Type

Standard Characters

Goods

Class 30

(1) brownies containing marijuana; chocolate bars infused with cannabis; chocolate containing cannabis;

Class 34

(2) cannabis cigarettes; cannabis for recreational use, for smoking; cannabis for recreational use, for vaporizing; cannabis for smoking; cannabis grinders; dried cannabis; dried marijuana; marijuana cigarettes; marijuana for smoking; marijuana grinders;

Services

Class 35

online sale of dried marijuana and cannabis for smoking; online sale of dried marijuana and cannabis recreational consumption; retail sale of cannabis; retail sale of cannabis; retail sale of derivatives of cannabis; retail sale of derivatives of cannabis; retail sale of dried marijuana and cannabis for smoking; retail sale of dried marijuana and cannabis for smoking; retail sale of dried marijuana and cannabis recreational consumption;

Application Number 2,036,692
Language of Application English

Filing Date 2020-06-26

APPLICANT AND AGENT DETAILS

Applicant

WOODSTREAM CORPORATION
29 East King Street, Suite 201
Lancaster, PA
17602
UNITED STATES OF AMERICA

Agent

LONNIE BRODKIN-SCHNEIDER
(MILLER THOMSON LLP), 1000, rue de la
Gauchetière Ouest, bureau 3700, Montréal,
QUEBEC, H3B4W5

TRADEMARK DETAILS

Hydro-Tech

Trademark Type

Standard Characters

Goods

Class 21

Lure specifically designed for use in insect and spider traps

Claims

Priority Filing Date: March 10, 2020, Country or Office: UNITED STATES OF AMERICA,
Application No: 88/828,884 in association with the same kind of goods

Application Number 2,036,981
Language of Application English

Filing Date 2020-06-29

APPLICANT DETAILS

Applicant
Sodadog Inc.
11 Parfield dr
M2J 1C1
Toronto
ONTARIO
M2J1C1

TRADEMARK DETAILS

Voilacafe

Trademark Type
Standard Characters

Goods

Class 21

(1) coffee mugs

Class 30

(2) beverages made of coffee; coffee-based beverages; non-alcoholic coffee-based beverages

Application Number 2,036,991
Language of Application English

Filing Date 2020-06-29

APPLICANT AND AGENT DETAILS

Applicant

TIBCO Software Inc.
3303 Hillview Avenue
Palo Alto, CA 94304
UNITED STATES OF AMERICA

Agent

DENTONS CANADA LLP
99 BANK STREET, SUITE 1420, OTTAWA,
ONTARIO, K1P1H4

TRADEMARK DETAILS

Trademark Type

Design

Visual Representation



Goods

Class 09

downloadable software used for monitoring and collecting data on individuals' conditions, such as health conditions, and local conditions, such as local health conditions, to determine acceptability of allowing individuals to assemble or work in a common environment;

Services

Class 42

providing temporary use of non-downloadable software for monitoring and collecting data on individuals' conditions, such as health conditions, and local conditions, such as local health conditions, to determine acceptability of allowing individuals to assemble or work in a common environment;

Application Number 2,037,240
Language of Application English

Filing Date 2020-06-30

APPLICANT DETAILS

Applicant

Baihan Wang
6780 boul newman
apt 602
lasalle,
QUEBEC
H8N0H5

TRADEMARK DETAILS

MeowPunch

Trademark Type

Standard Characters

Goods

Class 18

(1) animal identification collars; bags for carrying pets; bow ties for cats; cat collars; clothing for pets; collars for pets; dog apparel; dog clothing; dog coats; dog collars; dog collars and leads; dog shoes;

Class 20

(2) beds for household pets; cat baskets; cat beds; dog baskets; dog beds;

Class 21

(3) animal cages; automatic pet feeders; automatic pet waterers; brushes for pets;

Class 28

(4) cat toys; dog toys;

Application Number 2,038,006
Language of Application English

Filing Date 2020-07-03

APPLICANT DETAILS

Applicant

Millennia Law Corporation
203-2276 Clearbrook Rd
Abbotsford
BRITISH COLUMBIA
V2T2X5

TRADEMARK DETAILS

Natural Pictures

Trademark Type

Standard Characters

Goods

Class 09

DVDs containing movie recordings; DVDs containing recordings of television shows and movies; motion pictures; pre-recorded CDs and DVDs containing audio and video clips; video projectors; videocameras; videotapes and video disks recorded with animation

Services

Class 35

(1) advertising services for promoting a series of films for others; producing promotional videotapes, video discs, and audio visual recordings for others

Class 38

(2) broadcasting of film and television features via the Internet; broadcasting of films and television programmes via a video-on-demand service; broadcasting of motion picture films via the Internet; broadcasting of television programmes using video-on-demand and pay-per-view television services; broadcasting of television programs using video-on-demand and pay-per-view television services; providing streaming audio and video such as music, movies, television shows, music videos, news and sports webcasts via a website; streaming of audio and video via the Internet featuring music, movies, news, and sports; streaming of television shows and movies via the Internet; video streaming in the field of independent films; video streaming of independent films and movies via the Internet; video streaming services via the Internet featuring independent films and movies

Class 40

(3) conversion of motion picture film to video film; development of photographic films; film development; film development and reproduction of photographs; video transfer by providing colour correction and conversion of motion picture film to video film

Class 41

(4) digital imaging; film and video production; film distribution; film production; film rental; film studios; motion picture and video rental services; motion picture rental; operation of video

equipment and audio equipment for production of radio or television programs; post-production editing services in the field of music, videos and film; production of motion picture films; production of musical videos; providing films, not downloadable, via video-on-demand services; providing information in the field of television shows and movies via a website; providing movie reviews via a website; providing news, editorials, and opinions concerning current events via a website; providing television programmes, not downloadable, via video-on-demand services; providing television programmes, not downloadable, via video-on-demand transmission services; providing television programs, not downloadable, via video-on-demand services; providing video studios; rental of entertainment media in the nature of movies and films on DVDs; rental of videotapes; screenplay writing; scriptwriting services; video editing; video editing services for events; video film production; video tape editing; video tape film production; videotape editing; videotape editing services; videotaping

Class 45

(5) film, television and video licensing; legal services relating to the exploitation of ancillary rights relating to film, television, video and music productions; legal services relating to the protection and exploitation of copyright for film, television, theatre and music productions; licensing of rights relating to films; licensing of rights relating to video productions; licensing of rights to films, television and video productions; providing legal information from an online interactive database

Application Number 2,038,024
Language of Application English

Filing Date 2020-07-04

APPLICANT DETAILS

Applicant
OLIGEY E SHOP INC.
48-4991 No. 5 Rd
Richmond
BRITISH COLUMBIA
V6X0S9

TRADEMARK DETAILS

Trademark Type
Design

Visual Representation



Colour Claim

Colour is claimed as a feature of the trademark. The fur colour of the dog should be ivory with the lens of glasses in pink and the t-shirt in blue with white dots.

Goods

Class 03

(1) pet stain removers

Class 08

(2) animal hair clippers; pet nail trimmers

Class 11

(3) automatic water dispensers for pets; pet heat lamps

Class 18

(4) pet clothing; pet collars; pet leashes

Class 20

(5) beds for household pets; pet crates; pet cushions

Class 21

(6) pet bowls; pet cages; pet feeding dishes

Class 24

(7) blankets for household pets

Class 25

(8) casual clothing; neckerchiefs

Class 28

(9) pet toys; pet toys containing catnip; pet toys made of rope

Application Number 2,038,551
Language of Application English

Filing Date 2020-07-08

APPLICANT DETAILS

Applicant
MUV LOGISTICS NETWORK
TECHNOLOGIES LTD.
863 Belmont Dr SW,
Calgary,
ALBERTA
T2X4P2

TRADEMARK DETAILS

MUVEZ

Trademark Type
Standard Characters

Services

Class 35

(1) business administration in the field of transport and delivery; business management in the field of transport and delivery

Class 39

(2) moving services; parcel shipping services; rental of moving vans; supply chain logistics and reverse logistics services for the transportation of goods for others by air, rail, ship or truck; tracking and tracing of packages in transit; truck transport

Class 42

(3) design and development of computer software for supply chain logistics

Application Number 2,038,802
International Registration Number 1539883
Language of Application English

Filing Date 2020-06-08

APPLICANT AND AGENT DETAILS

Applicant

Truvian Sciences, Inc.
10300 Campus Point, Suite 190
San Diego CA 92121
UNITED STATES OF AMERICA

Agent

DLA PIPER (CANADA) LLP
Suite 2800, PARK PLACE, 666 BARRARD
STREET, VANCOUVER, BRITISH
COLUMBIA, V6C2Z7

TRADEMARK DETAILS

TruWellness Panel

Trademark Type

Standard Characters

Disclaimer

"PANEL"

Goods

Class 05

Medical diagnostic reagents and assays for testing of body fluids; diagnostic reagents for clinical and medical purposes.

Claims

Priority Filing Date: December 18, 2019, Country or Office: UNITED STATES OF AMERICA,
Application No: 88731748 in association with the same kind of goods

Application Number 2,040,005
International Registration Number 1541160
Language of Application English

Filing Date 2020-05-20

APPLICANT AND AGENT DETAILS

Applicant

CNH Industrial N.V.
25 St. James's Street
London SW1A 1HA
UNITED KINGDOM

Agent

COASTAL TRADEMARK SERVICES LIMITED
1081 Cambie Street, Vancouver, BRITISH
COLUMBIA, V6B5L7

TRADEMARK DETAILS

Trademark Type

Design

Visual Representation



Goods

Class 01

(1) Engine antifreeze and coolant; chemical engine treatment additives for engine oils, diesel fuels, and hydraulic and transmission fluids; hydraulic and transmissions fluids; hydraulic and transmissions oils.

Class 04

(2) Axle and gear fluids; industrial oils, namely, gear oils, motor oils and engine oils; industrial greases for automotive use; lubricants, namely, gear lubricants.

Claims

Priority Filing Date: May 15, 2020, Country or Office: UNITED KINGDOM, Application No: UK00003490345 in association with the same kind of goods

Application Number 2,040,187
Language of Application English

Filing Date 2020-07-16

APPLICANT DETAILS

Applicant

Chao Ma
706,Bldg.3, dongfang peninsula garden, bulong
Rd., longgang Dist
shenzhen, guangdong, 518000
CHINA

TRADEMARK DETAILS

Trademark Type

Design

Visual Representation



Goods

Class 15

banjos; carillons being musical instruments; drumheads; electronic musical instruments; guitars; harmonicas; harps; mandolins; melodicas; music stands; musical instrument drums; musical keyboard cases; musical keyboards; pedals for musical instruments; percussion instruments; reeds; stands for musical instruments; stringed musical instruments; tambourines; ukuleles

Application Number 2,040,203
Language of Application English

Filing Date 2020-07-16

APPLICANT DETAILS

Applicant

Burt Lancon
125 Chataway Blvd
Winnipeg
MANITOBA
R3P0A2

TRADEMARK DETAILS

Lilyfield Quarry

Trademark Type
Standard Characters

Goods

Class 19
limestone

Application Number 2,040,376
Language of Application English

Filing Date 2020-07-16

APPLICANT DETAILS

Applicant

Nutrial International Trade Ltd.
PO Box 2314 Richmond Hill B
Richmond Hill
ONTARIO
L4E1A5

TRADEMARK DETAILS

Trademark Type

Design

Visual Representation



Colour Claim

Colour is claimed as a feature of the trademark. The word 'Nutrial' is black. The maple leaf representing the cap of letter 'i' and the arc symbol in the lower left corner are dark red.

Disclaimer

The applicant disclaims the right to the exclusive use of the 11-point maple leaf

Goods

Class 16

(1) framed artwork; framed pictures; paintings and calligraphic works; paintings and their reproductions

Class 21

(2) bowls; candy dishes; coin banks; drip mats for tea; food storage containers; serving dishes

Class 27

(3) bath mats; door mats; floor mats

Application Number 2,040,929
Language of Application English

Filing Date 2020-07-21

APPLICANT AND AGENT DETAILS

Applicant

Molex, LLC
2222 Wellington Court
Lisle, IL 60532
UNITED STATES OF AMERICA

Agent

CPST INTELLECTUAL PROPERTY INC.
130 Queens Quay East, East Tower, Suite
809, Toronto, ONTARIO, M5A0P6

TRADEMARK DETAILS

INCEPTION

Trademark Type

Standard Characters

Goods

Class 09

Electrical connectors.

Claims

Priority Filing Date: July 15, 2020, Country or Office: UNITED STATES OF AMERICA, Application No: 90053460 in association with the same kind of goods

Application Number 2,041,044
Language of Application English

Filing Date 2020-07-21

APPLICANT DETAILS

Applicant

Znder Inc
370 overpeck pl
Englewood, NJ 07631
UNITED STATES OF AMERICA

TRADEMARK DETAILS

Trademark Type

Design

Visual Representation



Goods

Class 11

accent lights for indoor use; aquarium led underwater lights; automobile lights; boat trailer lights; ceiling lights; Christmas tree lights; directional lights for bicycles; diving lights; electric discharge tubes for lighting; electric flashlights; electric lamps; electric night lights; electric torches for lighting; fairy lights for festive decoration; floor lamps; globes for lamps; head lamps; helmet lights; infrared lamp fixtures; lamp bases; lamp reflectors; lamp shades; LED flashlights; led landscape lights; led underwater boat guiding lights; light bulbs; light bulbs for directional signals for vehicles; light diffusers; lighting fixtures; lights for bicycles; lights for vehicles; lights for wall mounting; map lights for vehicles; motorcycle lights; nail lamps; penlights; pet heat lamps; pocket search lights; reading lights; rear lights for vehicles; safety lamps for underground use; sockets for electric lights; solar powered lamps; street lights; UV halogen metal vapour lamps;

Application Number 2,041,167
Language of Application English

Filing Date 2020-07-22

APPLICANT AND AGENT DETAILS

Applicant

The Folger Coffee Company
One Strawberry Lane
Orrville, OH 44667
UNITED STATES OF AMERICA

Agent

MARY GARAVELLOS
(Smucker Foods of Canada Corp.), 80
Whitehall Drive , Markham, ONTARIO, L3R0P3

TRADEMARK DETAILS

THE BEST PART OF WAKIN' UP

Trademark Type

Standard Characters

Goods

Class 30

Coffee

Application Number 2,041,173
Language of Application English

Filing Date 2020-07-22

APPLICANT AND AGENT DETAILS

Applicant

The Folger Coffee Company
One Strawberry Lane
Orrville , OH 44667
UNITED STATES OF AMERICA

Agent

MARY GARAVELLOS
(Smucker Foods of Canada Corp.), 80
Whitehall Drive , Markham, ONTARIO, L3R0P3

TRADEMARK DETAILS

C'EST BIEN MEILLEUR DE S'RÉVEILLER

Trademark Type

Standard Characters

Goods

Class 30

Coffee

Application Number 2,041,177
Language of Application English

Filing Date 2020-07-22

APPLICANT AND AGENT DETAILS

Applicant

The Folger Coffee Company
One Strawberry Lane
Orrville, Ohio, 44667
UNITED STATES OF AMERICA

Agent

MARY GARAVELLOS
(Smucker Foods of Canada Corp.), 80
Whitehall Drive , Markham, ONTARIO, L3R0P3

TRADEMARK DETAILS

**C'EST BIEN MEILLEUR DE S'RÉVEILLEUR
QUAND ON A FOLGERS COMME CAFÉ**

Trademark Type

Standard Characters

Goods

Class 30

Coffee

Application Number 2,041,296
International Registration Number 1541443
Language of Application English

Filing Date 2020-04-22

APPLICANT AND AGENT DETAILS

Applicant

Kunshan Health&Beyond Inc.
Room 701-702 Bld2 Huijin Bld No.55,
Shangxiang Road,
Huaqiao Town
Kunshan
CHINA

Agent

NEOMARK LTD.
7450 rue Saint-Hubert, Montréal, QUEBEC,
H2R2N3

TRADEMARK DETAILS

Trademark Type

Design

Visual Representation

health&beyond

Goods

Class 03

(1) Badian essence; shampoos for pets; beauty masks; lotions for cosmetic purposes; deodorants for human beings; deodorants for pets.

Class 05

(2) Disinfectants for household purposes; all purpose disinfectants; air purifying preparations; antibacterial handwashes; antiseptics; germicides; vaginal washes for medical purposes; ethyl alcohol for medical purposes; air deodorizing preparations.

Application Number 2,041,923
Language of Application English

Filing Date 2020-07-24

APPLICANT DETAILS

Applicant

Kirk Jones
164 Couling Crescent
Guelph
ONTARIO
N1E0L1

TRADEMARK DETAILS

kajscape

Trademark Type

Standard Characters

Services

Class 41

aerial photography; digital photography; film and video production; photographic computer imaging; photography; portrait photography

Application Number 2,042,350
Language of Application English

Filing Date 2020-07-28

APPLICANT AND AGENT DETAILS

Applicant

Netflix Studios, LLC
5808 W Sunset Blvd
Los Angeles, CA 90028
UNITED STATES OF AMERICA

Agent

CLARK WILSON LLP
900 - 885 WEST GEORGIA STREET,
VANCOUVER, BRITISH COLUMBIA, V6C3H1

TRADEMARK DETAILS

CAPTAIN FALL

Trademark Type

Standard Characters

Services

Class 41

Entertainment services in the nature of a comedic drama television series; providing online non-downloadable video clips and multimedia entertainment recordings containing audio files, video files, artwork, and informational text from and related to a comedic drama television series

Application Number 2,042,551
Language of Application English

Filing Date 2020-07-29

APPLICANT AND AGENT DETAILS

Applicant
EMBOUTEILLAGE CANADA INC.
169 Rue Sainte-Claire
Saguenay
QUEBEC
G7G2S4

Agent
ROBIC
630, boul. René-Lévesque Ouest, 20e étage,
Montréal, QUEBEC, H3B1S6

TRADEMARK DETAILS

Trademark Type
Design

Visual Representation



Disclaimer

The right to the exclusive use of The applicant disclaims the right to the exclusive use of the eleven-point maple leaf apart from the trademark. is disclaimed apart from the trademark.

Goods

Class 30
mustard

Application Number 2,042,743
International Registration Number 1543131
Language of Application English

Filing Date 2020-05-19

APPLICANT AND AGENT DETAILS

Applicant

CNH Industrial N.V.
25 St. James's Street
London SW1A 1HA
UNITED KINGDOM

Agent

COASTAL TRADEMARK SERVICES LIMITED
1081 Cambie Street, Vancouver, BRITISH
COLUMBIA, V6B5L7

TRADEMARK DETAILS

Trademark Type

Design

Visual Representation



Goods

Class 01

(1) Engine antifreeze and coolant; chemical engine treatment additives for engine oils, diesel fuels, and hydraulic and transmission fluids; hydraulic and transmissions fluids; hydraulic and transmissions oils.

Class 04

(2) Lubricating oils for axles and gears, other than chemical based; industrial oils, namely, gear oils, motor oils and engine oils; industrial greases for automotive use; lubricants, namely, gear lubricants.

Claims

Priority Filing Date: May 15, 2020, Country or Office: UNITED KINGDOM, Application No: UK00003490351 in association with the same kind of goods

Application Number 2,043,051
Language of Application English

Filing Date 2020-07-30

APPLICANT DETAILS

Applicant

Orb Cloud Services, Inc.
6 Scissons Rd
Kanata
ONTARIO
K2M2X2

TRADEMARK DETAILS

orb

Trademark Type

Standard Characters

Services

Class 42

cloud computing web hosting services

Application Number 2,043,408
Language of Application English

Filing Date 2020-07-31

APPLICANT DETAILS

Applicant

Orb Cloud Services, Inc.
6 Scissons Rd
Kanata
ONTARIO
K2M2X2

TRADEMARK DETAILS

Trademark Type

Design

Visual Representation



orb.

Services

Class 42

cloud computing web hosting services

Application Number 2,043,463
Language of Application English

Filing Date 2020-08-01

APPLICANT DETAILS

Applicant

Luc Beaudoin Bioflash
748 boul. des Vétérans
Sherbrooke
QUEBEC
J1N1Z7

TRADEMARK DETAILS

Alzhei-set

Trademark Type

Standard Characters

Goods

Class 05

(1) lecithin dietary supplements; pharmaceutical preparations for the treatment of brain diseases and disorders, namely, epilepsy, Alzheimer's, cerebral palsy, Parkinson's disease, multiple sclerosis; pharmaceutical preparations for the treatment of degenerative nerve diseases and disorders, namely, Alzheimer's disease, Parkinson's disease, Huntington's disease and multiple sclerosis; pharmaceutical preparations for the treatment of degenerative nerve diseases and disorders, namely, Alzheimer's disease, Parkinson's disease, Huntington's disease and multiple sclerosis; yeast dietary supplements

Class 30

(2) biscuits; butter biscuits; buttermilk biscuits; cereal-based bars; cereal-based snack food; cookies; granola bars; muffins

Application Number 2,043,471
Language of Application English

Filing Date 2020-08-01

APPLICANT DETAILS

Applicant

Devin Belanger
15 E Royal Avenue
New Westminster
BRITISH COLUMBIA
V3L0A8

TRADEMARK DETAILS

Miles Away

Trademark Type

Standard Characters

Goods

Class 09

audio tapes featuring music; CD music recordings; CD-ROMs containing music; CDs containing audio recordings of live musical performances; compact discs containing music; compact discs featuring music; digital music downloadable from internet; digital music downloadable from the Internet; downloadable digital music; downloadable electronic sheet music; downloadable music; downloadable music files; downloadable music for mobile telephones, handheld computers and tablet computers; downloadable video recordings featuring music; prerecorded audio tapes featuring music; prerecorded music compact discs

Services

Class 41

arranging and conducting musical concerts; composition of music; DJ services; entertainment in the form of live musical concerts; entertainment in the form of live performances by a musical band; entertainment services in the nature of live performances by a musical band; instruction in the field of music; music composition; music composition services; music instruction; production of music records; production of musical videos

Application Number 2,043,510
Language of Application English

Filing Date 2020-08-03

APPLICANT DETAILS

Applicant

Shamira Tranqui
10 Parklawn Road
Suite 1009
Etobicoke
ONTARIO
M8V0H9

TRADEMARK DETAILS

Plato The Penguin

Trademark Type

Standard Characters

Goods

Class 09

(1) downloadable digital books; downloadable electronic books; electronic books

Class 16

(2) children's books; children's storybooks; colouring books; educational books

Class 28

(3) educational games for children; plastic toy figurines; plush toys; plush toys with attached comfort blanket; soft toys; stuffed and plush toys; toy clocks and watches; toy dolls; toy figures; toy figurines

Application Number 2,043,513
Language of Application English

Filing Date 2020-08-03

APPLICANT DETAILS

Applicant

9072-7975 Quebec Inc.
4935 Rue Saint-Gabriel
Pierrefonds
QUEBEC
H8Y1Z7

TRADEMARK DETAILS

RacerOne

Trademark Type
Standard Characters

Goods

Class 12

bicycle frames; bicycle handle bars; bicycle handles; bicycle parts; bicycle pedals; bicycle pumps;
bicycle seats; bicycle tires; bicycle wheels; cranks for cycles

Application Number 2,043,727
Language of Application English

Filing Date 2020-08-04

APPLICANT DETAILS

Applicant
Ophelia Sarakinis
219 Chemin Senneville
Senneville
QUEBEC
H9X3X3

TRADEMARK DETAILS

Vertité

Trademark Type
Standard Characters

Goods

Class 31

fresh strawberries

Application Number 2,044,078
International Registration Number 1544199
Language of Application French

Filing Date 2020-06-08

APPLICANT AND AGENT DETAILS

Applicant

Philip Morris Products S.A.
Quai Jeanrenaud 3
CH-2000 Neuchâtel
SUISSE

Agent

GOWLING WLG (CANADA) LLP
SUITE 1600, 1 FIRST CANADIAN PLACE, 100
KING STREET WEST, TORONTO, ONTARIO,
M5X1G5

TRADEMARK DETAILS

IQOS ILUMA PRIME

Trademark Type

Standard Characters

Goods

Class 34

Wired vaporizers for e-cigarettes and electronic smoking apparatus, namely portable heating apparatus and portable generators for the inhalation of an aerosol containing nicotine; raw or manufactured tobacco; tobacco products, including cigars, cigarettes, cigarillos, tobacco for roll-your-own cigarettes, tobacco for pipes, chewing tobacco, snuff, kretek; snus; tobacco substitutes other than for medical use, namely liquid nicotine solutions for use in e-cigarettes; smokers' articles in the nature of cigarette papers and tubes, filters for cigarettes, tobacco boxes, cigarette cases and ashtrays, smoking pipes, pocket-size cigarette rolling machines, lighters for smokers; matches; tobacco sticks, heatable tobacco products, electronic apparatus and their parts, for heating cigarettes or tobacco in order to release aerosols containing nicotine inhalants; liquid nicotine solutions for use in e-cigarettes; electronic smoking apparatus, namely portable electronic heaters; e-cigarettes; e-cigarettes used as substitutes for traditional cigarettes; electronic devices, namely portable heating apparatus and portable generators for the inhalation of aerosols containing nicotine; oral vaporizers for smokers, tobacco products and tobacco substitutes; smokers' articles for e-cigarettes, namely atomizers for cigarettes, cartridges, envelopes, caps, bands, springs, cleaning kits for e-cigarettes, namely cleaning rods and cleaning brushes, e-cigarette boxes, tobacco flavourings and liquid flavouring solutions for e-cigarettes, and parts and components for the aforesaid goods; fire-extinguishing apparatus for cigarettes and cigars, as well as heated tobacco sticks; cases for rechargeable e-cigarettes.

Claims

Priority Filing Date: May 15, 2020, Country or Office: ANDORRA, Application No: 34993 in association with the same kind of goods

Application Number 2,044,131
International Registration Number 1544329
Language of Application French

Filing Date 2020-06-23

APPLICANT AND AGENT DETAILS

Applicant

Philip Morris Products S.A.
Quai Jeanrenaud 3
CH-2000 Neuchâtel
SUISSE

Agent

GOWLING WLG (CANADA) LLP
SUITE 1600, 1 FIRST CANADIAN PLACE, 100
KING STREET WEST, TORONTO, ONTARIO,
M5X1G5

TRADEMARK DETAILS

Trademark Type

Design

Visual Representation



Goods

Class 34

Wired vaporizers for e-cigarettes and electronic smoking apparatus, namely portable heating apparatus and portable generators for the inhalation of an aerosol containing nicotine; raw or manufactured tobacco; tobacco products, including cigars, cigarettes, cigarillos, tobacco for roll-your-own cigarettes, tobacco for pipes, chewing tobacco, snuff, kretek; snus; tobacco substitutes other than for medical use, namely liquid nicotine solutions for use in e-cigarettes; smokers' articles in the nature of cigarette papers and tubes, filters for cigarettes, tobacco boxes, cigarette cases and ashtrays, smoking pipes, pocket-size cigarette rolling machines, lighters for smokers; matches; tobacco sticks, heatable tobacco products, electronic apparatus and their parts, for heating cigarettes or tobacco in order to release aerosols containing nicotine inhalants; liquid nicotine solutions for use in e-cigarettes; electronic smoking apparatus, namely portable electronic heaters; e-cigarettes; e-cigarettes used as substitutes for traditional cigarettes; electronic devices, namely portable heating apparatus and portable generators for the inhalation of aerosols containing nicotine; oral vaporizers for smokers, tobacco products and tobacco substitutes; smokers' articles for e-cigarettes, namely atomizers for cigarettes, cartridges, envelopes, caps,

bands, springs, cleaning kits for e-cigarettes, namely cleaning rods and cleaning brushes, e-cigarette boxes, tobacco flavourings and liquid flavouring solutions for e-cigarettes, and parts and components for the aforesaid goods; fire-extinguishing apparatus for cigarettes and cigars, as well as heated tobacco sticks; cases for rechargeable e-cigarettes.

Claims

Priority Filing Date: June 16, 2020, Country or Office: ANDORRA, Application No: 35046 in association with the same kind of goods

Application Number 2,044,487
Language of Application English

Filing Date 2020-08-06

APPLICANT AND AGENT DETAILS

Applicant

MAG CANADA BEVERAGE LTD.
Unit 100 - 565 Great Northern Way
Vancouver
BRITISH COLUMBIA
V5T0H8

Agent

GOWLING WLG (CANADA) LLP
550 BURRARD STREET, SUITE 2300,
VANCOUVER, BRITISH COLUMBIA, V6C2B5

TRADEMARK DETAILS

WHITE CLAW HARD SELTZER

Trademark Type

Standard Characters

Goods

Class 18

(1) Athletic bags; backpacks, book bags, sports bags, bum bags, wallets and handbags; business card cases; collars for pets; duffle bags; garments for pets; leather bags; luggage; umbrellas

Class 21

(2) Barbecue mitts; beer glasses; beverage glassware; cooler bags; cork screws; cups and mugs; dinnerware; drinking flasks; ice buckets; insulated flasks; isothermic bags; vacuum bottles; vacuum flasks

Class 25

(3) Athletic apparel; athletic footwear; baby clothing; balaclavas; bandanas; baseball caps and hats; beach clothes; belts; caps; casual clothing; casual footwear; coats; dress clothing; gloves; Halloween costumes; hats; head bands; jackets; loungewear; shoes; sleepwear; slippers; sneakers; socks; sportswear; swimwear; toques; undergarments

Class 32

(4) ale; beer; beer-based cocktails; flavoured beers; lager; porter; stout;

Class 33

(5) alcoholic cocktails; alcoholic cocktails in the form of chilled gelatins; alcoholic coolers; alcoholic fruit drinks; alcoholic lemonade; alcoholic malt-based coolers; alcoholic punches; alcoholic seltzer; hard seltzer; vodka seltzer;

Application Number 2,044,692
Language of Application English

Filing Date 2020-08-08

APPLICANT DETAILS

Applicant

Venji Production Studio Inc.
21 Cambridge Dr.,
Charlottetown
PRINCE EDWARD ISLAND
C1C1P1

TRADEMARK DETAILS

Trademark Type

Design

Visual Representation



Goods

Class 09

(1) audio books; CD cases; CD-ROMs containing computer games; compact discs containing computer games; computer game cartridges; computer game programs; computer game software; computer games; computer games for use on mobile and cellular phones; computer hardware; computer joysticks; computer keyboards; computer keypads; computer network server; computer software for organizing and viewing digital images and photographs; flash memory cards; graphics cards

Class 16

(2) advertising signs of cardboard; advertising signs of paper; art paper; art prints; cardboard; cardboard boxes; cardboard containers; score cards; scratch cards

Class 28

(3) action figure toys; action skill games; action target games; arcade game machines; arcade video game machines; Chinese checkers games; computer game consoles; computer video game joysticks; computerized video game tables for gaming; construction toys; educational games for children; educational toys; electronic educational game machines designed for children; electronic hand-held games; game cards; gamepads for use with electronic games; gamepads for video games; gaming chips; gaming tables; hand-held electronic video games; joypads for use with electronic games; joypads for use with game consoles; playing cards; role playing games; small toys; trading card games

Services

Class 41

book publishing; bookmobile services; computer training; digital imaging; event planning; film and video production; magazine publishing; magazine writing; music composition; online electronic publishing of books and periodicals; online video gaming services; photographic computer imaging; production of news webcasts; production of video games; providing on-line computer games; publication and editing of printed matter; publication of audio books; publication of books; publication of books and magazines; publication of books, magazines and newspapers on the Internet; publication of brochures; publication of catalogs; publication of electronic books and journals on-line; publishing of books; publishing of books and reviews; video production

Application Number 2,044,865
Language of Application English

Filing Date 2020-08-10

APPLICANT DETAILS

Applicant

Baris Karaagac
114 Colin Ave
Toronto
ONTARIO
M5P2C3

TRADEMARK DETAILS

Trademark Type

Design

Visual Representation



Goods

Class 14

beads for making jewelry; beads for use in the manufacture of jewelry; charms for jewelry; clasps for jewelry; cloisonné jewelry; custom jewelry; fitted jewelry pouches; gold thread jewelry; hat jewelry; ivory jewelry; jewelry; jewelry and imitation jewelry; jewelry boxes; jewelry brooches; jewelry cases; jewelry cases of precious metal; jewelry caskets of precious metal; jewelry chains; jewelry charms; jewelry clips for adapting pierced earrings to clip-on earrings; jewelry dishes; jewelry findings; jewelry for the head; jewelry hat pins; jewelry of yellow amber; jewelry organizer cases; jewelry organizer rolls for travel; jewelry rings; jewelry rolls for storage; jewelry rolls for travel; jewelry stickpins; jewelry watches; musical jewelry boxes; presentation boxes for jewelry; shoe jewelry; silver jewelry; small jewelry boxes; women's jewelry; wooden jewelry boxes

Application Number 2,044,890
Language of Application English

Filing Date 2020-08-10

APPLICANT AND AGENT DETAILS

Applicant

CANADA VONOVO FOOD TECHNOLOGY
LTD
1906-1133 HORNBY ST
VANCOUVER
BRITISH COLUMBIA
V6Z1W1

Agent

MILTONS IP/P.I.
15 Fitzgerald Rd, Suite 200, Ottawa,
ONTARIO, K2H9G1

TRADEMARK DETAILS

VONOVO

Trademark Type

Standard Characters

Goods

Class 30

breakfast cereals; cereal-based snack food; honey; noodle-based prepared meals; rice-based snack food; starch for food

Services

Class 35

(1) advertising agency services; business management and enterprise organization consultancy; marketing analysis services; on-line advertising the goods and services of others on computer communications networks; providing an online commercial information directory on the Internet; sales promotion for others by means of privileged user cards

Class 44

(2) advisory services relating to weight control; dietary and nutritional guidance; medical clinic services; medical screening; nutrition counseling; nutritional advisory services; public health counselling; services of a psychologist; telemedicine services; weight reduction diet planning and supervision services

Application Number 2,044,891
Language of Application English

Filing Date 2020-08-10

APPLICANT DETAILS

Applicant

NINGBO QILI DIANZISHANGWU
YOUXIANGONGSI
Rm 112(Trusteeship4015),Bld#.21,
689 Lane Changxing RD, Jiangbei DIST,
Ningbo City Zhejiang Province, 315000
CHINA

TRADEMARK DETAILS

Trademark Type

Design

Visual Representation

EGOFINE

Goods

Class 20

bolsters; boxes of wood or plastic; chopping blocks; clothes hangers; curtain rings; curtain rods; cushions; dinner wagons being furniture; display stands; filing cabinets; fodder racks; hat stands; kennels for household pets; mattresses; nesting boxes for household pets; office furniture; pet cushions; picture frame brackets; picture frames; pillows; plate racks; sideboards; slatted indoor blinds; writing desks

Application Number 2,044,895
Language of Application English

Filing Date 2020-08-10

APPLICANT DETAILS

Applicant

LIDING TANG
RM101. BUILDING 5, NO.2 FENGWEI RD.
WUXI, 214000
CHINA

TRADEMARK DETAILS

ILM

Trademark Type

Standard Characters

Goods

Class 09

baseball batting helmets; baseball catchers' helmets; batting helmets; bicycle helmets; boxing helmets; buoyancy helmets; catchers' helmets; chin straps for American football helmets; chin straps for football helmets; crash helmets; crash helmets for motorcyclists; diving helmets; eye shields for sports helmets; face shields for protective helmets; face shields for sports helmets; football helmets; helmet camera mounts; helmet cameras; helmets for bicycles; helmets for ice hockey; helmets for motorcyclists; hockey helmets; horse riding helmets; motorcycle goggles; motorcycle helmets; mounts for helmet cameras; protective face-shields for protective helmets; protective helmets for boxing; protective helmets for cyclists; protective helmets for motorcyclists; protective helmets for motorists; protective helmets for sports; protective sports helmets; riding helmets; safety helmets; skateboard helmets; skateboarding helmets; ski helmets; snowboarding helmets; solderers' helmets; sports helmets; visors for helmets; welding helmets

Application Number 2,044,900
Language of Application English

Filing Date 2020-08-11

APPLICANT DETAILS

Applicant

LIDING TANG
RM101. BUILDING 5, NO.2 FENGWEI RD.
WUXI, 214000
CHINA

TRADEMARK DETAILS

MADBIKE

Trademark Type

Standard Characters

Goods

Class 25

(1) bicycle gloves; boots for motorcycling; cycling gloves; driving gloves; fingerless gloves; gloves; gloves with conductive fingertips; gloves with conductive fingertips that may be worn while using hand-held electronic touch screen devices; gloves with conductive fingertips that may be worn while using handheld electronic touch screen devices; knitted gloves; leather gloves; motorcycle boots; motorcycle gloves; motorcycle jackets; riding gloves; sheepskin gloves; skateboarding gloves; ski gloves; windjammers for motorcycles; winter gloves

Class 28

(2) American football gloves; archery gloves; baseball batting gloves; baseball gloves; batting gloves; bowling gloves; boxing gloves; fencing gloves; field hockey gloves; football gloves; gloves for archery; gloves for golf; gloves for soccer goalkeepers; gloves for water-skiing; goalkeeper's gloves; golf gloves; handball gloves; hockey gloves; ice hockey gloves; karate gloves; lacrosse gloves; racketball gloves; skydiving gloves; soccer goalkeepers' gloves; softball gloves

Application Number 2,044,904
Language of Application English

Filing Date 2020-08-11

APPLICANT AND AGENT DETAILS

Applicant

Hanghang LU
No.17, 12 Heng,Longtianlongzhongwai,
Guangyi Street, Chenghai District
Shantou,Guangdong,
CHINA

Agent

MILTONS IP/P.I.
15 Fitzgerald Rd, Suite 200, Ottawa,
ONTARIO, K2H9G1

TRADEMARK DETAILS

Trademark Type

Design

Visual Representation

MIEBELY

Goods

Class 28

abdominal boards for exercise; bells for Christmas trees; children's multiple activity toys; controllers for toy planes; cube-type puzzles; educational games for children; infant toys; jigsaw puzzles; musical toys; playing balls; remote-controlled toy vehicles; toy animals; toy building blocks; toy food; toy guns; toy robots; toy sling planes; toy vehicles; toy vehicles which transform into robots; video game consoles

Application Number 2,044,911
Language of Application English

Filing Date 2020-08-11

APPLICANT AND AGENT DETAILS

Applicant

Karaka LLC
1 East Erie St., Suite 525-4600
Chicago, IL 60611
UNITED STATES OF AMERICA

Agent

CYNTHIA D. MASON
(Mason Professional Corporation), 1000
Innovation Drive, Suite 500, Kanata,
ONTARIO, K2K3E7

TRADEMARK DETAILS

Sleep Mantra

Trademark Type

Standard Characters

Goods

Class 20

(1) air mattresses; bed mattresses; decorative pillows; mattress toppers; mattresses and pillows

Class 24

(2) baby blankets; bath sheets; bed and table linen; bed blankets; bed blankets made of cotton; bed blankets made of man-made fibres; bed blankets made of wool; bed canopies; bed covers; bed covers of paper; bed linen; bed linen of paper; bed pads; bed quilts; bed sheet sets; bed sheets; bed sheets for children; bed sheets of paper; bed skirts; bed spreads; bed throws; bed valances; bedsheets; bedspreads; blanket throws; blankets; blankets for babies; blankets for children; blankets for household pets; blankets for outdoor use; children's bed linen; children's bed sheets; children's blankets; children's pillow cases; contour sheets; contoured mattress covers; cotton face towels; cotton hand towels; cotton towels; coverlets; covers for cushions; covers for duvets; covers for quilts; crib sheets; cushion covers; duvet covers; duvets; fitted bed sheets for pets; fitted mattress covers; fitted sheets; fitted sheets for pet beds; infants' bed linen; mattress covers; pillow cases; pillow covers; pillow protectors; pillow shams; pillow slips; pillowcases; printed fabrics; quilt covers; quilted blankets; quilts; quilts filled with down; quilts of textile; quilts of towel; satin; satin fabrics; shams; sheets; sheets for cribs; silk bed blankets; silk blankets; silk cloth; silk cotton; silk fabric; silk fabrics; swaddling blankets; textile fabrics for use in the manufacture of bedding; textile hand towels; textile printers' blankets; textile quilts; textiles for clothes; throws; valance sheets; valanced bed covers; valanced bed sheets; velvet; velvet fabric; woolen blankets; woollen blankets

Application Number 2,045,226
Language of Application English

Filing Date 2020-08-12

APPLICANT DETAILS

Applicant

Certn Holdings Inc.
300-1006 Fort St
Victoria
BRITISH COLUMBIA
V8V3K4

TRADEMARK DETAILS

Certn

Trademark Type

Standard Characters

Services

Class 35

(1) business management services relating to information and data compiling and analyzing;
human resources outsourcing services

Class 36

(2) credit bureau services; insurance services; property management consulting services

Class 42

(3) software as a service (SaaS) provider in the field of human resources management

Application Number 2,045,229
Language of Application English

Filing Date 2020-08-12

APPLICANT DETAILS

Applicant

eko technologies canada inc.
216-7250 Keele St
Concord
ONTARIO
L4K1Z8

TRADEMARK DETAILS

eko jetwave

Trademark Type

Standard Characters

Goods

Class 11

bidets; toilet seats

Application Number 2,045,605
Language of Application English

Filing Date 2020-08-12

APPLICANT DETAILS

Applicant

10194794 Canada Inc.
407-350 The East Mall
Etobicoke
ONTARIO
M9B3Z7

TRADEMARK DETAILS

Aquaera

Trademark Type

Standard Characters

Goods

Class 11

aerators for faucets; air cleaning units; air deodorizing apparatus; air filtering units for removing dust, smoke and allergens from the air; air humidifiers; air purifiers for household purposes; air purifying units; aquarium filters; aquarium filtration apparatus; automatic faucets; automatic water dispensers for pets; bath plumbing fixtures; beverage dispensing machines; cooling evaporators; decorative tabletop water fountains; dehumidifiers; dehumidifiers for household purposes; dehumidifiers for household use; desalination units; domestic water jug filters; electric bath-water purifying apparatus for household purposes; faucets; filters for drinking water; hand showers; household tap-water filters; humidifiers; humidifiers for household purposes; portable foot baths; portable water filters for humanitarian emergencies; rainwater purification installations; reverse osmosis water purification units; spray heads for showers; tap water faucets; tap-water purifying apparatus; ultraviolet light (UV) water purification device; ultraviolet sterilizers for water treatment; water conditioning units; water filtering units for domestic use; water filtering units for industrial use; water filtration bottles sold empty; water filtration jugs; water ionizers for household purposes; water purification machines for domestic use; water softening units; water sterilisers; water treatment plant filters

Application Number 2,045,620
International Registration Number 1440253
Language of Application English

Filing Date 2020-07-29

APPLICANT DETAILS

Applicant

MOIN, Inc.
6F, 22, Seocho-daero 78-gil,
Seocho-gu
Seoul
REPUBLIC OF KOREA

TRADEMARK DETAILS

Trademark Type

Design

Visual Representation

MOIN

Services

Class 36

Virtual money brokerage; exchanging virtual money; financial trading; financing services, namely, financing of loans; provision of information in the field of financing of loans, mergers and investments; financial brokerage; mobile banking; money transfer services; online banking; brokerage services relating to electronic money (bitcoin) exchange; provision of pricing information about electronic money (bitcoin); trusteeship of electronic money (bitcoin); trust administration relating to electronic money (bitcoin) deposit taking; electronic money transactions; electronic money managements; issuance of electronic money; electronic transfers of money; electronic funds transfer by telecommunications; providing financial information relating to exchange rates; credit scoring services

Application Number 2,045,645
Language of Application English

Filing Date 2020-08-12

APPLICANT DETAILS

Applicant

Fitudio Inc.
5-170 Bovaird Dr W
Brampton
ONTARIO
L7A1A1

TRADEMARK DETAILS

SimpleTK

Trademark Type
Standard Characters

Goods

Class 09

audio/video cable connectors; audio/video cables; computer cables; desktop computers

Application Number 2,046,026
Language of Application English

Filing Date 2020-08-16

APPLICANT DETAILS

Applicant

Bevin Chen,
Wayne Wai Yin Law
22-505 Hood Rd
Markham
ONTARIO
L3R5V6

TRADEMARK DETAILS

PANDACO

Trademark Type

Standard Characters

Goods

Class 09

audio speaker enclosures; audio speakers; audio/video cable connectors; audio/video cables; bags and cases specially adapted for holding or carrying portable telephones and telephone equipment and accessories; batteries for cell phones; batteries for mobile phones; battery cases; battery chargers for cell phones; battery chargers for cellular phones; beeper carrying cases; blank USB cards; blank USB flash drives; cable connectors; camcorder cases; camera cases; carrying cases for cell phones; carrying cases for cellular phones; cases adapted for cellular phones; cases adapted for mobile phones; cases for mobile phones; cell phone antennas; cell phone batteries; cell phone battery chargers; cell phone battery chargers for use in vehicles; cell phone cases; cell phone cases made of leather or imitations of leather; cell phone covers; cell phone holders; cell phone straps; cell phones; cellular phone batteries; cellular phone battery chargers for use in vehicles; cellular phone cases; cellular phone straps; cellular phones; clear protective covers adapted for cellular phones; clear protective covers adapted for mobile phones; computer keyboards; computer mouse; computer mouse mats; computer mouse pads; computer speakers; covers for cellular phones; covers for tablet computers; digital tablets; digitizer tablets; digitizing tablets; display screen filters adapted for use with tablet computers; docking stations for cell phones; docking stations for cellular phones; docking stations for mobile phones; ear phones; earphones; earphones and headphones; flip covers for smart phones; hands free kits for phones; hands-free headsets for cellular phones; hands-free headsets for mobile phones; hands-free holders for cell phones; hands-free holders for mobile phones; hands-free kits for cellular phones; hands-free microphones for cell phones; hands-free microphones for mobile phones; headsets for cell phones; headsets for mobile phones; keyboards for cellular phones; keyboards for computers; keyboards for mobile phones; keyboards for mobile telephones; keypads for cell phones; keypads for mobile phones; lanyards for cell phones; lanyards for mobile phones; leather cases for cell phones; leather cases for mobile phones; mobile phone batteries; mobile phone chargers; mobile phone covers; mobile phone straps; mobile phones; mouse mats; mouse pads; mousepads; multifunction computer keyboards; multifunction keyboards; protective cases for cell phones; protective cases for cellular phones; protective cases for mobile phones; protective films adapted

for smart phones; screen savers; smart phones; smart phones; speakers for computers; stands adapted for mobile phones; straps for cellular phones; straps for mobile phones; telephone sets with screen and keyboard; USB cables for cellular phones; USB cables for mobile phones; wireless computer mice; wireless headsets for use with mobile phones; wrist rests for use with computer keyboards

Application Number 2,046,289
Language of Application English

Filing Date 2020-08-18

APPLICANT AND AGENT DETAILS

Applicant

8074836 Canada Ltd.
5792 Grande Allée
Saint-Hubert
QUEBEC
J3Y1B2

Agent

AG AVOCAT CONSEIL INC.
4101, Sherbrooke West, Montréal, QUEBEC,
H3Z1A7

TRADEMARK DETAILS

SMOKE OUT

Trademark Type

Standard Characters

Goods

Class 03

(1) air fragrance reed diffusers; aromatherapy oils; aromatic essential oils; incense and incense cones; incense sticks

Class 04

(2) aromatherapy fragrance candles; candles; scented candles; tealight candles; votive candles

Application Number 2,046,370
Language of Application English

Filing Date 2020-08-18

APPLICANT DETAILS

Applicant

cvetelina thomas
2416 Shepard Ave
Mississauga
ONTARIO
L5A2H6

TRADEMARK DETAILS

one stop non stop real estate service

Trademark Type

Standard Characters

Services

Class 35

(1) advertising of commercial real estate for others; advertising of residential real estate for others; arranging and conducting of real estate auctions; real estate advertising services for others; real estate marketing analysis services; real estate sales management services

Class 36

(2) acquisition of real estate for others; ad valorem appraisals of real estate; appraisal of real estate; appraisals for insurance claims of real estate; arranging of leases and rental agreements for real estate; assessment and management of real estate; estate planning; estate trust management; estate trust planning; evaluation of real property; financial valuation of personal property and real estate; lease of real estate; leasing of real estate; on-line real-time currency trading; real estate agencies; real estate agency services; real estate appraisal; real estate appraisal and valuation; real estate appraisals; real estate brokerage; real estate brokers; real estate consultancy; real estate consultation; real estate investment; real estate investment services; real estate management; real estate management services; real estate syndication; real estate time sharing; real estate valuation services; rental of real estate; valuations in real estate matters

Application Number 2,046,374
Language of Application English

Filing Date 2020-08-18

APPLICANT DETAILS

Applicant

Cvetelina Thomas
2416 Shepard Ave
Mississauga
ONTARIO
L5A2H6

TRADEMARK DETAILS

Ratereturn

Trademark Type

Standard Characters

Services

Class 35

(1) advertising of commercial real estate for others; advertising of residential real estate for others; arranging and conducting of real estate auctions; real estate advertising services for others; real estate marketing analysis services; real estate sales management services

Class 36

(2) acquisition of real estate for others; ad valorem appraisals of real estate; appraisal of real estate; appraisals for insurance claims of real estate; arranging of leases and rental agreements for real estate; assessment and management of real estate; estate planning; estate trust management; estate trust planning; evaluation of real property; financial valuation of personal property and real estate; lease of real estate; leasing of real estate; on-line real-time currency trading; real estate agencies; real estate agency services; real estate appraisal; real estate appraisal and valuation; real estate appraisals; real estate brokerage; real estate brokers; real estate consultancy; real estate consultation; real estate investment; real estate investment services; real estate management; real estate management services; real estate syndication; real estate time sharing; real estate valuation services; rental of real estate; valuations in real estate matters

Application Number 2,046,768
International Registration Number 1546094
Language of Application English

Filing Date 2020-05-28

APPLICANT AND AGENT DETAILS

Applicant

HELIOT EMIL ApS
Skjulhøj Allé 23 C, st.
DK-2720 Vanløse
DENMARK

Agent

NORTON ROSE FULBRIGHT CANADA LLP/S.
E.N.C.R.L.,S.R.L.
1, Place Ville Marie, Suite 2500, Montreal,
QUEBEC, H3B1R1

TRADEMARK DETAILS

HELIOT EMIL

Trademark Type

Standard Characters

Goods

Class 18

(1) Belt bags (hipsacks); all-purpose carrying bags; gentlemen's handbags; men's bags, women's bags; handbags; handbags made of leather; ladies' handbags; purses and wallets; shopping bags; rucksacks; bags made of leather; clutch bags; credit card cases [wallets]; leather wallets; cross-body bags.

Class 25

(2) Denim jackets; down jackets; jackets [clothing]; coats; leather jackets; shirts; cagoules; gilets; long-sleeved shirts; sweaters; Tee-shirts; printed t-shirts; tank tops; belts [clothing]; leather belts [clothing]; trousers of leather; bathing trunks; chino pants; sweatpants; boxer shorts; shorts; knitted gloves; wind vests; sneakers; socks; blazers; bikinis; ladies' clothing; coats for women; ladies' sandals; boots; ladies' boots; hats; caps being headwear; beanies; ladies' dresses; skirts; scarves; short-sleeve shirts; blouses; crop tops; wind resistant jackets; down vests; hooded sweat shirts; denim jeans; pants.

Services

Class 35

Online retail store services relating to clothing; wholesale services in relation to clothing; wholesale services in relation to clothing and clothing accessories; organisation of exhibitions and trade fairs for commercial or advertising purposes in relation to clothing; administration of loyalty programs involving discounts or incentives; advertising and marketing services relating to clothing provided by means of social media; publicity and sales promotion services in relation to clothing; targeted marketing; promoting the sale of fashion goods through promotional articles in magazines, namely catalogue shopping services in the field of clothing; retail services in the field of clothing; retail services in relation to clothing accessories

Claims

Priority Filing Date: November 29, 2019, Country or Office: DENMARK, Application No: VA 2019 02693 in association with the same kind of goods and in association with the same kind of services

Application Number 2,046,789
International Registration Number 1545955
Language of Application English

Filing Date 2020-06-04

APPLICANT AND AGENT DETAILS

Applicant

Guilin Zhishen Information Technology Co., Ltd.
6th Floor, Building No. 13,
Creative Industrial Park,
Guimo Road,
Qixing District, Guilin
541004 Guangxi
CHINA

Agent

NEOMARK LTD.
7450 rue Saint-Hubert, Montréal, QUEBEC,
H2R2N3

TRADEMARK DETAILS

Trademark Type

Design

Visual Representation

ZY CAMI

Goods

Class 09

Downloadable applications for mobile phones to connect and control cameras and smartphone stabilizers; downloadable applications for mobile phones to take and edit photographs and videos; communications computers; computer software platforms for social networking; stands adapted for mobile phones; tripods for cameras; cases especially made for photographic apparatus and instruments; integrated circuits; selfie sticks [hand-held monopods]; distance sensors

Claims

Priority Filing Date: April 07, 2020, Country or Office: CHINA, Application No: 45212062 in association with the same kind of goods

Application Number 2,047,096
Language of Application English

Filing Date 2020-08-20

APPLICANT DETAILS

Applicant

Cloud Crafters Inc
2024 41 St NW
Edmonton
ALBERTA
T6L6L2

TRADEMARK DETAILS

CLOUD CRAFTERS

Trademark Type

Standard Characters

Services

Class 35

(1) web indexing for commercial or advertising purposes; web site optimization services; web site traffic optimisation; web site traffic optimization

Class 39

(2) flower delivery; furniture delivery; parcel delivery; pizza delivery

Class 42

(3) updating websites for others; web hosting; web site design consultancy; website design; website design consultancy; website development for others

Class 43

(4) restaurants featuring home delivery

Application Number 2,047,453
Language of Application English

Filing Date 2020-08-24

APPLICANT DETAILS

Applicant

Pocean Botanicals Inc.
985 Calverhall St
North Vancouver
BRITISH COLUMBIA
V7L1Y1

TRADEMARK DETAILS

Hand Sanity

Trademark Type

Standard Characters

Goods

Class 03

(1) cosmetic creams and gels for the face, hands and body; cosmetic creams, milks, lotions, gels and powders for the face, hands and body; cosmetic hand creams; cosmetic powders, creams and lotions for the face, hands and body; moisturizing body lotions; moisturizing lotions; moisturizing skin lotions; skin moisturizers

Class 05

(2) alcohol-based antibacterial skin sanitizer gels; all purpose disinfectants; all purpose sanitizers; all-purpose disinfectants; anti-microbial hand wash; antibacterial hand lotions; antibacterial hand wash; antibacterial sprays; disinfectant soap; disposable sanitizing wipes; hand sanitizers; hand-sanitizing preparations; sanitizing wipes

Application Number 2,047,456
Language of Application English

Filing Date 2020-08-24

APPLICANT DETAILS

Applicant

Catherine Linton
3915 Sharon Place
V7V 4T6
West Vancouver
BRITISH COLUMBIA
V7V4T6

TRADEMARK DETAILS

Woofit

Trademark Type

Standard Characters

Goods

Class 05

(1) pet food additives in the form of vitamins and minerals

Class 31

(2) cat food; dog food; food for pets; pet food; puppy food

Services

Class 35

(1) online sales of food items

Class 44

(2) dietary and nutritional guidance; food and nutrition consultation services

Application Number 2,047,622
Language of Application English

Filing Date 2020-08-25

APPLICANT DETAILS

Applicant

Vesuvius Media Ltd
38 Pioneer Ave
Halifax
NOVA SCOTIA
B3M1W8

TRADEMARK DETAILS

Pacific Rails Inc

Trademark Type
Standard Characters

Goods

Class 28

board games; table top games

Application Number 2,047,678
Language of Application English

Filing Date 2020-08-25

APPLICANT AND AGENT DETAILS

Applicant

Joshua Turner
3854 Centennial Dr
Saskatoon
SASKATCHEWAN
S7L5K9

Agent

RYAN SHEBELSKI
Locus Law, 114-310 Wall Street W, Saskatoon,
SASKATCHEWAN, S7K1N7

TRADEMARK DETAILS

SASKAMPER

Trademark Type

Standard Characters

Goods

Class 25

athletic shoes; baseball caps and hats; boots; casual shoes; gloves; hats; hiking shoes; jackets; long-sleeved t-shirts; pajamas; pants; sandals; sandals and beach shoes; scarves; short-sleeved t-shirts; socks; sweaters; t-shirts; thong sandals; toques; underwear

Application Number 2,047,679
Language of Application English

Filing Date 2020-08-25

APPLICANT DETAILS

Applicant

Diane Dufour
100-57 Auriga Drive
K2E 8B2
Ottawa
ONTARIO
K2E8B2

TRADEMARK DETAILS

ezU Pro-Shield

Trademark Type

Standard Characters

Goods

Class 10

face shields for medical use

Application Number 2,047,731
Language of Application English

Filing Date 2020-08-25

APPLICANT AND AGENT DETAILS

Applicant

Snaphouss Inc.
7030 Woodbine Avenue
Suite 500
Markham
ONTARIO
L3R6G2

Agent

GARFINKLE BIDERMAN LLP
Dundee Place, Suite 801, 1 Adelaide Street
East, Toronto, ONTARIO, M5C2V9

TRADEMARK DETAILS

SNAPHOUSS

Trademark Type

Standard Characters

Services

Class 35

advertising of commercial real estate for others; advertising of residential real estate for others; advice in the field of business management and marketing; real estate advertising services for others; real estate marketing analysis services

Application Number 2,047,744
Language of Application English

Filing Date 2020-08-26

APPLICANT DETAILS

Applicant

Hou Shu Deng
407 Santun,Henshan,Dongshan Cun,Danzhu
Guigang, 537313
CHINA

TRADEMARK DETAILS

CrystalTears

Trademark Type

Standard Characters

Goods

Class 14

ankle bracelets; beads for making jewellery; bracelets; charms for key chains; charms for key rings; earrings; jewellery; key chains; key rings; necklaces; pendants; precious and semi-precious stones; semi-precious gemstones; semi-precious stones

Application Number 2,047,745
Language of Application English

Filing Date 2020-08-26

APPLICANT DETAILS

Applicant

Chuanqu Luo
No.16 Group3 Anyan, Geao Vil, Shangtian
Town, Fenghua District
Ningbo, Zhejiang,
CHINA

TRADEMARK DETAILS

ANZESE

Trademark Type

Standard Characters

Goods

Class 20

(1) air mattresses; bag hangers of plastic; bamboo curtains; bathroom furniture; bead curtains for decoration; bean bags; bedroom furniture; bedroom furniture parts; beds for household pets; birdhouses; book stands; bumper guards for furniture; camping furniture; chair pads; chairs; childrens' sleeping mats; clips of plastic for sealing bags; coat stands; computer furniture; computer furniture parts; cork furniture knobs; costume display stands; costume stands; cupboards; curtain hooks; curtain rails; curtain rings; curtain rods; curtain rollers; curtain tie-backs; cushions; decorative bead curtains; desks; dining room furniture; dining room furniture parts; dinner wagons being furniture; display boards; display racks; display stands; doors for furniture; drawers that are furniture parts; edgings of plastic for furniture; freestanding furniture partitions; furniture buffets; furniture cabinets; furniture chests; furniture coasters; furniture cushions; furniture doors; furniture flower stands; furniture for camping; hat stands; inflatable furniture; jewellery organizer display stands; kennels for household pets; lap desks; nesting boxes for household pets; newspaper display stands; office desks; oriental single panel standing partition [tsuitate]; pet beds; pet crates; pet cushions; portable desks; shower curtain hooks; sleeping bag pads; sleeping mats; sleeping pads; standing desks; stands for calculators; typing desks; umbrella stands; valet stands; works of art of nutshell; writing desks

Class 21

(2) bakeware; baking pans; bottle stands; cake decorating tips and tubes; cake molds; cake moulds; cake rings; cake servers; cake stands; cat litter boxes; clothes drying racks; cookie jars; cooking pans; cooking strainers; cooking utensils; cruet stands; drying racks for laundry; food storage containers; frying pans; garden sprinklers; ice cube molds; ice cube moulds; jars; lawn sprinklers; litter boxes for pets; lunch boxes; lunch pails; nozzles for watering hose; pet litter box liners; pots and pans; pots and pans scrapers; reusable ice cubes; reusable silicone food covers; spice racks; sprinklers for watering flowers and plants; stands for portable baby baths; stands for shaving brushes; stew-pans; tea strainers

Application Number 2,047,746
Language of Application English

Filing Date 2020-08-26

APPLICANT DETAILS

Applicant
YUK SHING MAK
FLAT/RM C BLK 2 3/F, KWUN TONG
INDUSTRIAL, CENTRE, 460-470 KWUN TONG
KL HONG KONG,
CHINA

TRADEMARK DETAILS

JOVIVI

Trademark Type
Standard Characters

Goods

Class 14

ankle bracelets; beads for making jewellery; bracelets; charms for key chains; charms for key rings; earrings; jewellery; key chains; key rings; necklaces; pendants; precious and semi-precious stones; semi-precious gemstones; semi-precious stones

Application Number 2,047,748
Language of Application English

Filing Date 2020-08-26

APPLICANT DETAILS

Applicant

SEGA INTERNATIONAL LIMITED
42-3710 Allan Dr SW
Edmonton
ALBERTA
T6W2C4

TRADEMARK DETAILS

Trademark Type

Design

Visual Representation



Goods

Class 18

(1) airline travel bags; all purpose sport bags; all-purpose athletic bags; all-purpose carrying bags; all-purpose leather straps; all-purpose sports bags; alpenstocks; animal game bags; animal harnesses; animal hides; animal identification collars; animal leads; animal leashes; animal muzzles; animal skins; animal skins and hides; ankle-mounted wallets; artificial fur; athletic bags; attache cases made of imitation leather; attache cases made of leather; attaché cases; attaché cases of imitation leather; attaché cases of leather; baby backpacks; baby carriers worn on the body; baby carrying bags; baby changing bags; back frames for carrying children; back packs; backpacks; backpacks for carrying babies; backpacks, book bags, sports bags, bum bags, wallets and handbags; baggage tags; bags for campers; bags for carrying animals; bags for climbers; bags for sports; bags for sports clothing; bags for umbrellas; bags made of leather; bags of leather; bandoliers; bands of leather; banknote holders in the nature of wallets; barrel bags; beach bags; beach parasols; beach umbrellas; beachbags; beauty cases; bellybands for dogs; belt bags; belt bags and hip bags; billfolds; bits for animals; bits for horses; blinders; blinders for horses; blinders for poultry to prevent fighting; blinkers for horses; book bags; Boston bags; boxes of imitation leather; boxes of leather; boxes of leather or leather board; boxes of leather or leatherboard; boxes of leatherboard; boxes of vulcanised fibre; boxes of vulcanized fiber; boxes of vulcanized fibre; bridles for horses; bridoons; briefbags; briefcase-type portfolios; briefcases; briefcases for documents; bum bags; bumbags; business card cases; business card cases in the nature of wallets; business cases; calling card cases; cane handles; canes; canes and walking sticks; canes*; canvas bags for shopping; canvas wood carriers; card cases; card wallets; carry-all bags; carryalls; carrying cases for documents; cases for holding keys; cases for keys; cat collars; cat o'

nine tails; catalogue cases; cattle skins; chain mesh handbags; chain mesh purses; chain mesh purses of precious metal; chamois leather; change purses; changing bags; charm bags (omamori-ire); children's shoulder bags; chin straps, of leather; choke chains; clothing for animals; clothing for dogs; clothing for domestic pets; clothing for pets; clutch bags; clutch handbags; clutch purses; coats for cats; coats for dogs; coin purse frames; coin purses; coin purses made of leather; coin purses of precious metal; collars for cats; collars for dogs; collars for pets; collars for pets bearing medical information; compression cubes adapted for luggage; conference folders; conference portfolios; cords of leather; cosmetic bags; cosmetic bags sold empty; cosmetic cases; cosmetic cases sold empty; cosmetic purses; costumes for animals; courier bags; covers for horse saddles; credit card cases; credit card cases of leather; credit card holders; credit card holders of leather; credit card wallets; credit card wallets of leather; cross-body bags; curried skins; cushion padding made for saddlery; daypacks; diaper bags; document cases; document suitcases; dog apparel; dog bellybands; dog clothing; dog coats; dog collars; dog collars and leads; dog leads; dog leashes; dog parkas; dog shoes; drawstring bags; drawstring pouches; duffel bags; duffel bags for travel; duffle bags; duffle bags for travel; electronic pet collars; equestrian brassware; equine boots; equine leg wraps; evening bags; evening handbags; evening purses; face masks for equines; fake fur; falconry hoods; fanny packs; fashion handbags; fastenings for saddles; faux fur; feed bags; feed bags for animals; felt pouches; flexible bags for garments; flight bags; fly masks for animals; fly masks for horses; fly sheets for horses; folding briefcases; folding walking sticks; footlockers; frames for coin purses; frames for luggage; frames for parasols; frames for umbrellas; frames for umbrellas or parasols; fur; fur pelts; fur-skins; furniture coverings of leather; furs; furs sold in bulk; garment bags for travel; garment bags for travel made of leather; garment carriers; garments for pets; general purpose sport trolley bags; gentlemen's handbags; gentlemens handbags; girths of leather; gladstone bags; goldbeaters' skin; golf bag tags of leather; golf umbrellas; grips for holding shopping bags; grocery tote bags; gym bags; halters; halters for animals; handbag frames; handbag straps; handbags; handbags for ladies; handbags for men; handbags made of imitation leather; handbags made of leather; handbags made of precious metal; handbags, purses and wallets; handles for canes; handles for canes and walking sticks; handles for walking sticks; handles for walking-sticks; handles of canes and walking-sticks; harness bits; harness bridles; harness fittings of iron; harness fittings of precious metal; harness for animals; harness for horses; harness reins; harness straps; harness traces; harnesses and saddlery; harnesses for guiding children; hat boxes for travel; hat boxes of imitation leather; hat boxes of leather; haversacks; head-stalls; hides; hiking bags; hiking poles; hiking rucksacks; hiking sticks; hip bags; hipsacks; holdalls; holdalls for sports clothing; hoof guards; horse bits; horse blankets; horse bridles; horse collars; horse fly sheets; horse halters; horse harnesses; horse leg wraps; horse quarter sheets; horse rugs; horse saddles; horse tacks; horse tail wraps; horseshoes; horseshoes made of plastic; horseshoes of metal; hunters' game bags; hunting bags; hunting crops; imitation fur; imitation leather; imitation leather bags; imitation leather cases; imitation leather handbags; imitation leather sold in bulk; industrial packaging containers of leather; infant carriers worn on the body; janome-gasa [Japanese oiled-paper umbrellas]; Japanese oiled-paper umbrellas [janome-gasa]; Japanese paper umbrellas (karakasa); Japanese utility pouches (shingen-bukuro); jewellery bags of textile material sold empty; jockey sticks; karakasa [Japanese paper umbrellas]; key bags; key cases; key cases of imitation leather; key cases of leather; key cases of leather or imitation leather; key pouches; key wallets; key-cases; key-cases of leather and skins; keycases; kid; kit bags; knapsacks; knee-pads for horses; knitted bags; knitting bags; kori wicker trunks; labels of leather; ladies' handbags; leads for animals; leads for dogs; leads for pets; leashes for animals; leashes for dogs; leashes for guiding children; leashes for pets; leather; leather and imitation leather; leather and imitation leather bags; leather and imitations of leather; leather attaché cases; leather bags; leather bags and wallets; leather bags for packaging; leather

boxes; leather briefcases; leather cases; leather cases for keys; leather coin purses; leather cords; leather credit card cases; leather credit card holder; leather credit card holders; leather credit card wallets; leather envelopes for merchandise packaging; leather for furniture; leather for harnesses; leather for shoes; leather handbags; leather hat boxes; leather key cases; leather laces; leather leads; leather leashes; leather luggage straps; leather luggage tags; leather notecases; leather pouches; leather pouches for merchandise packaging; leather purses; leather shopping bags; leather shoulder belts; leather shoulder straps; leather sold in bulk; leather straps; leather suitcases; leather thongs; leather thread; leather tool bags; leather travelling bags; leather travelling suitcases; leather trimmings for furniture; leather wallets; leather-board boxes; leatherboard; leatherboard boxes; leathercloth; leg wraps for horses; leggings for animals; lockable luggage straps; lockable straps for luggage; luggage; luggage and trunks; luggage label holders; luggage straps; luggage tags; luggage tags for travel baggage; luggage tags made of leather; luggage tags made of metal; luggage tags made of plastic; luggage tags made of rubber; luggage trunks; luggage trunks and suitcases; lunge reins; lunges; make-up bags; make-up bags sold empty; mesh bags for shopping; mesh shopping bags; messenger bags; metal horseshoes; metal luggage tags; metal parts of canes and walking-sticks; metal parts of umbrellas; moleskin being imitation of leather; motorized suitcases; mountaineering sticks; multi-purpose handbags; multi-purpose purses; multipurpose purses; music bags; music cases; name card cases; nappy bags; net bags for shopping; nose bags; omamori-ire [charm bags]; overnight bags; overnight suitcases; packaging bags of leather; pads for riding saddles; parasols; parasols and walking sticks; parts of rubber for stirrups; pelts; pet clothing; pet collars; pet collars bearing medical information; pet leads; pet leashes; plastic luggage labels; plastic luggage tags; pocket wallets; pocketbooks; portmanteau; portmanteaus; portmanteaux; pouch baby carriers; pouches for holding keys; pouches of leather; poultry blinders to prevent fighting; poultry blinkers to prevent fighting; protective suit carriers; Pullman cases; purse frames; purses; purses and wallets; rainproof parasols; randsels [Japanese school satchels]; raw hides; raw skins; rawhide chews for dogs; rawhides; reins for equestrian sports; reins for guiding children; reticule; reticules; reusable shopping bags; riding crops; riding saddles; roll bags; roller bags; roller suitcases; rubber luggage tags; rubber parts for stirrups; ruckpaks; rucksacks; rucksacks for mountaineers; rucksacks on casters; saddle belts; saddle blankets; saddle cloths for horses; saddle covers; saddle trees; saddlebags; saddlecloths for horses; saddlery; saddlery of leather; saddles; saddletrees; satchels; school backpacks; school bags; school book bags; school knapsacks; school satchels; schoolbags; schoolchildren's backpacks; semi-worked fur; shaving bags sold empty; shingen-bukuro [Japanese utility pouches]; shoe bags; shoe bags for travel; shopping bags; shopping bags made of skin; shopping bags with wheels attached; shoulder bags; shoulder belts of leather; shoulder straps; shoulder straps of leather; skins and hides; sling bags for carrying babies; sling bags for carrying infants; slings for carrying infants; slouch handbags; small backpacks; small bags for men; small clutch handbags; small clutch purses; small coin purses; small handbags; small purses; small rucksacks; small suitcases; souvenir bags; spats and knee bandages for horses; specialty holsters adapted for carrying folding walking sticks; sponge bags; sport bags; sports bags; sports packs; sportsman's hunting bags; stirrup leathers; stirrup straps; stirrups; stirrups of metal; straps for coin purses; straps for handbags; straps for luggage; straps for skates; straps for soldiers' equipment; string bags for shopping; suit bags; suit bags for travel; suit carriers; suitcase handles; suitcases; suitcases with wheels; sun umbrellas; sunshade parasols; synthetic fur; synthetic leather; tail wraps for horses; tanned leather; telescopic umbrellas; textile shopping bags; tie cases; tie cases for travel; tips specially adapted for hiking poles; tips specially adapted for hiking sticks; tips specially adapted for trekking poles; tips specially adapted for trekking sticks; tips specially adapted for wading staffs; tips specially adapted for walking staffs; tips specially adapted for walking sticks; toilet bags; toiletry bags; toiletry bags sold empty; toiletry cases sold empty; tool

bags; tool bags of leather; tool bags sold empty; tool pouches sold empty; tote bags; train cases; training leads; training leads for horses; travel bags; travel cases; travel garment covers; travel handbags; travel kits; travel luggage; travel trunks; travel wallets; travelling bags; travelling cases of leather; travelling trunks; trekking poles; trekking sticks; trimmings of leather for furniture; trolley bags; trolley duffel bags; trolley duffels; trolley suitcases; trolley-type suitcases; trunks and suitcases; umbrella covers; umbrella frames; umbrella handles; umbrella or parasol ribs; umbrella rings; umbrella sticks; umbrellas; umbrellas and parasols; umbrellas and their parts; umbrellas for children; un-worked leather; unfitted vanity cases; unworked leather; unwrought and semi-wrought leather; valises; vanity cases; vanity cases sold empty; wading staffs; waist bags; waist packs; waist pouches; walking cane handles; walking canes; walking staffs; walking stick handles; walking stick seats; walking sticks; wallet fobs; wallets; wallets for attachment to belts; wallets including card holders; wallets of precious metal; wallets with card compartments; wash bags for carrying toiletries; weekend bags; wheeled bags; wheeled shopping bags; wheeled suitcases; whips; whips and saddlery; wrist-mounted money purses; wrist-mounted wallets

Class 25

(2) A-shirts; adhesive bras; adhesive brassieres; adult pajamas; adult sweatpants; after-ski boots; albs; altar clothes; anglers' shoes; ankle boots; ankle socks; anklet socks; anoraks; anti-perspirant socks; anti-slip soles; aprons; aqua shoes; ascots; athletic apparel; athletic clothing; athletic footwear; athletic shoes; athletic shorts; athletic tights; athletic wear; babies' bibs of plastic; babies' underwear; baby booties; baby bottoms; baby clothes; baby clothing; baby doll pyjamas; baby layettes for clothing; baby pants; baby sandals; baeja [traditional Korean waistcoats for women]; bags specially adapted for ski boots; balaclavas; ball gowns; ballet flats; ballet shoes; ballet slippers; ballroom dancing shoes; bandanas; bandannas; barber smocks; baseball caps; baseball caps and hats; baseball cleats; baseball jerseys; baseball shirts; baseball shoes; baseball uniforms; basic upper garment of Korean traditional clothes [Jeogori]; basketball boots; basketball shoes; basketball sneakers; bath robes; bath sandals; bath slippers; bath wraps; bathing caps; bathing costumes; bathing costumes for women; bathing drawers; bathing suits; bathing suits for men; bathing trunks; bathrobes; beach clothes; beach coats; beach cover-ups; beach footwear; beach jackets; beach pyjamas; beach robes; beach shoes; beach wraps; beachwear; bed jackets; belts; belts made from imitation leather; belts made of leather; belts made out of cloth; belts of textile; berets; bermuda shorts; bib overalls; bib shorts; bicycle gloves; bike shoes; bikini bottoms; bikini tops; bikinis; blanket sleepers; blazers; blouses; blousons; blue jeans; boardshorts; body stockings; body suits; boleros; bolo ties; bomber jackets; bomber vests; bonnets; boot bags; boot cuffs; boot uppers; booties; boots; boots for motorcycling; boots for snowboarding; bow ties; bow-ties; bowling shoes; boxer briefs; boxer shorts; boxing shoes; boxing shorts; bras; brassières; breeches for wear; bridal footwear; bridal headpieces; bridal wear; bridesmaid dresses; briefs; business attire; business clothing; bustiers; bustle holder bands for obi [obiage]; bustles for obi-knots [obiage-shin]; button down shirts; caftans; camisoles; camouflage clothing for hunting; canvas shoes; cap peaks; cap visors; capelets; capes; capes for use in hair salons and barber shops; capri pants; caps; caps with visors; car coats; cardigans; cargo pants; cashmere jackets; cashmere sweaters; cassocks; casual clothing; casual clothing featuring pants, dresses and shorts; casual footwear; casual pants; casual shirts; casual shoes; casual wear; chaps; chasubles; chefs' hats; chemises undergarments; chemisettes; children's clothing; children's footwear; children's shirts; Chinese gowns [Cheongsams]; christening gowns; climbing boots; climbing footwear; cloaks; clogs; cloth bibs; cloth hats; clothing belts; clothing cuffs; clothing for gymnastics; clothing for wear in judo practices; clothing for wear in wrestling games; clothing in particular pants; clothing in the nature of pants; clothing particularly pants; coats; coats for men; coats for men and women; coats for women; coats made of cotton; coats of denim; cocktail dresses; collar

protectors; collared shirts; corduroy trousers; corselets; corset undergarment; corsets; cotton neckties; coveralls; cravates; cravats; crop tops; cuffs; culottes; cummerbunds; curling shoes; curling sliders; cycling gloves; cycling jackets; cycling shoes; cycling shorts; cyclists' clothing; datejime [tightening-up strings for kimonos]; datemaki [wrap belts for kimonos]; deck-shoes; denim coats; denim jackets; denim jeans; denim pants; denim shirts; detachable neckpieces for kimonos [haneri]; dickies; down jackets; dress clothing; dress pants; dress shields for clothing; dress shirts; dress shoes; dress skirts; dress suits; dresses; dresses made from skins; dressing gowns; dressing gowns and bath robes; driving gloves; duffel coats; duffle coats; dungarees; durumagi [Korean overcoats]; dust coats; duster coats; ear muffs; earmuffs; embossed soles and heels of rubber or of plastic materials; espadrilles; esparto shoes or sandals; evening coats; evening dresses; evening footwear; evening gowns; exercise footwear; exercise wear; fabric belts; fairy wings; fake fur jackets; fashion hats; fedoras; fencing vests; field hockey shoes; fingerless gloves; fishermen's jackets; fishing clothing; fishing hip waders; fishing tackle vests; fishing vests; fishing waders; fitted swimming costumes with bra cups; fittings of metal for footwear; fleece jackets; fleece pants; fleece pullovers; fleece shirts; fleece shorts; fleece tops; fleece vests; flight suits; flip-flops; folk costumes; football boots; football boots and studs therefor; football cleats; football shoes; football uniforms; footwear cushioning; footwear for track and field athletics; formal wear; foundation corsets; foundation girdles; frocks; full-length kimonos [nagagi]; full-length slips; fur coats and jackets; fur hats; fur jackets; fur muffs; fur stoles; g-strings; gaiter straps; gaiters; galoshes; garter belts; garters; geta [Japanese style wooden clogs]; girdles; girdles for athletic use; gloves; gloves with conductive fingertips; gloves with conductive fingertips that may be worn while using hand-held electronic touch screen devices; gloves with conductive fingertips that may be worn while using handheld electronic touch screen devices; golf caps; golf cleats; golf footwear; golf hats; golf jackets; golf knickers; golf pants; golf shirts; golf shoes; golf shorts; golf skirts; golf trousers; golf wear; goloshes; gowns; greatcoats; grippers for curling shoes; gym boots; gym shorts; gym suits; gym wear; gymnastic shoes; hairdressing capes; hakama [pleated skirts for formal kimonos]; half slips; half-boots; Halloween costumes; halter tops; handball shoes; hats; head bands; head scarves; head sweatbands; headbands; headbands against sweating; headscarfs; headscarves; heavy jackets; heel inserts; heel pieces for shoes; heel protectors for shoes; heelpieces for footwear; heelpieces for stockings; heels; high rain clogs (ashida); hiking boots; hiking shoes; hockey jerseys; hockey shoes; hockey sweaters; hockey uniforms; hooded jackets; hooded pullovers; hooded sweatshirts; hooded tops; horse-riding boots; hosiery; hot pants; housecoats; hunting boots; infant clothing; infant footwear; infants' boots; infants' shoes; infants' shoes and boots; infants' trousers; inner soles; insoles; insoles for footwear; insoles for shoes and boots; intimate apparel; jackets; jackets and socks; Japanese sleeping robes [nemaki]; Japanese style clogs and sandals; Japanese style sandals [zori]; Japanese style sandals of felt; Japanese style sandals of leather; Japanese style socks [tabi covers]; Japanese style socks [tabi]; Japanese style wooden clogs [geta]; Japanese toe-strap sandals [asaura-zori]; jean jackets; jeans; jeans coveralls; jerkins; jikatabi [Japanese split-toed work footwear]; jodhpurs; jogging pants; jogging shoes; jogging suits; judo suits; judo uniforms; jump suits; jumper dresses; jumpers; jumpsuits; karate suits; karate uniforms; kendo outfits; kerchiefs; kilts; kimonos; knee highs; knee-high stockings; knee-length stockings; knickers; knit hats; knit jackets; knit shirts; knit skirts; knit tops; knitted caps; knitted gloves; knitted hats; knitted shirts; knitted sweaters; knitted tops; knitted underwear; koma-geta [low wooden clogs]; korean outer jackets worn over basic garment [magoja]; korean topcoats [durumagi]; korean traditional women's waistcoats [baeja]; koshimaki [undershirts for kimonos]; lab coats; lace boots; lace shawls; ladies' boots; ladies' suits; ladies' underwear; latex costumes; latex suits; layettes; leather belts; leather coats; leather gloves; leather jackets; leather pants; leather shoes; leather slippers; leather trousers; leg warmers; leg-warmers; legwarmers; leisure shoes; leisure suits; leotards; light-reflecting coats; light-reflecting jackets;

lingerie; liveries; long jackets; long sleeve pullovers; long sleeve shirts; long sleeved vests; long underwear; long-sleeve blouses; long-sleeved t-shirts; loungewear; lounging pyjamas; low wooden clogs [hiyori-geta]; low wooden clogs [koma-geta]; maillots; maniples; mantillas; mantle cloaks; martial arts uniforms; masquerade costumes; maternity underwear; maternity wear; medical personnel footwear; men's sandals; men's shirts; men's socks; men's suits; men's underwear; metal fittings for Japanese style wooden clogs; metal fittings for Japanese-style wooden clogs; military clothing; military uniforms; mittens; moccasins; mock turtleneck shirts; moisture-wicking sports bras; moisture-wicking sports pants; money belts; monokinis; morning coats; motorcycle boots; motorcycle gloves; motorcycle jackets; motorcyclist boots; mountain bike shoes; mountaineering boots; mountaineering shoes; muffler scarves; mukluks; mules; muscle shirts; muu muus; muumuus; nagagi [full-length kimonos]; neck bands; neck ties; neck warmers; neckerchiefs; neckerchieves; neckties; negligees; nemaki [Japanese sleeping robes]; night dresses; night gowns; night shirts; nightcaps; nightdresses; nightgowns; nighties; nightshirts; nightwear; non-slip soles; novelty hats; nurse pants; nurses' uniforms; nylon stockings; obi [sash bands for kimonos]; obiage [bustle holder bands for obi]; obiage-shin [bustles for obi-knots]; one-piece bathing suits; open-necked shirts; outdoor winter clothing; outdoor winter footwear; outerwear jackets; over-trousers; overalls; overcoats; overshoes; pajama bottoms; pajamas; pant suits; panties; pants; panty girdles; pantyhose; paper hats for use as clothing items; pareos; pareus; parkas; party hats for use as clothing items; pea coats; pedicure slippers; peignoirs; perspiration absorbent underwear; perspiration absorbent underwear clothing; petticoats; pinafore dresses; pinafores; pique shirts; platform soles; pleated skirts for formal kimonos [hakama]; pocket kerchiefs; pocket squares; pockets for clothing; polo shirts; ponchos; pregnancy smocks; promotional caps; promotional t-shirts; protective metal members for shoes and boots; protective tips for footwear; pullovers; puttees; pyjamas; rain boots; rain coats; rain footwear; rain hats; rain jackets; rain pants; rain ponchos; rain suits; rain trousers; raincoats; rainproof jackets; rainwear; riding boots; riding gloves; riding jackets; riding shoes; rubber boots; rubber fishing boots; rubber shoes; rubber soles for jikatabi; rugby boots; rugby shirts; rugby shoes; rugby shorts; rugby tops; running shoes; running shorts; sabots; safari jackets; sandal-clogs; sandals; sandals and beach shoes; sarees; saris; sarongs; sash bands for kimono [obi]; sashes; sashes for wear; scarves; school uniforms; sedge hats (suge-gasa); serapes; shampoo capes; shawls; shawls and headscarves; shawls and stoles; sheepskin coats; sheepskin gloves; sheepskin jackets; shell jackets; shirt fronts; shirt yokes; shirt-jacs; shirts; shirts for suits; shoe soles; shoe soles for repair; shoe uppers; shoes; shoes soles for repair; short overcoat for kimono [haori]; short pants; short petticoats; short trousers; short-sleeve shirts; short-sleeved shirts; short-sleeved t-shirts; shortalls; shorts; shoulder scarves; shoulder wraps; shower caps; silk neckties; silk scarves; skateboarding gloves; ski and snowboard shoes and parts thereof; ski bibs; ski boot bags; ski boots; ski clothing; ski footwear; ski gloves; ski jackets; ski pants; ski slacks; ski suits; ski suits for competition; ski trousers; ski vests; ski wear; skiing shoes; skirt suits; skirts; skirts and dresses; skiwear; skorts; skull caps; slacks; sleep masks; sleeping garments; sleepwear; sleeved jackets; sleeveless jackets; sleeveless jerseys; slipovers; slipper socks; slipper soles; slippers; slips; small hats; smocks; smoking jackets; snap crotch shirts for infants and toddlers; sneakers; snow boarding suits; snow boots; snow pants; snow suits; snow trousers; snowboard boots; snowboard jackets; snowboard pants; snowboard shoes; snowboard trousers; snowmobile suits; soccer boots; soccer shoes; soccer uniforms; sock garters; sock suspenders; socks; socks and stockings; softball caps; softball cleats; soles for footwear; soles for Japanese style sandals; spats; sport bibs; sport coats; sport jackets; sport shirts; sport stockings; sports bras; sports caps and hats; sports clothing; sports coats; sports footwear; sports jackets; sports jerseys; sports jerseys and breeches for sports; sports overuniforms; sports shirts with short sleeves; sports shoes; sports singlets; sports uniforms; sports vests; sportswear; stocking suspenders; stoles; strapless bras; strapless brassieres; straw

hats; string fasteners for haori [haori-himo]; studs for football boots; suede jackets; suit vests; suits; suits of leather; sun hats; sun protective clothing; sun suits; sun visors; suspender belts; suspender belts for men; suspender belts for women; suspender braces; suspenders; sweat bands; sweat jackets; sweat pants; sweat shirts; sweat socks; sweat suits; sweat tops; sweat-absorbent socks; sweat-absorbent stockings; sweat-absorbent underclothing; sweat-absorbent underwear; sweatbands; sweaters; sweatshirts; swim caps; swim suits; swim wear for gentlemen and ladies; swimming caps; swimming costumes; swimming suit bottoms; swimming trunks; swimsuits; swimwear; t-shirts; tabi [Japanese-style socks]; Taekwondo suits; tams; tank tops; tankinis; tap pants; team jerseys; team shirts; tee-shirts; tennis shirts; tennis shoes; tennis shorts; tennis wear; theatrical costumes; thermal socks; thermal underwear; thong sandals; thong underwear; three-piece suits; ties; tightening-up strings for kimonos (datejime); tights; tips for footwear; toe straps for Japanese style sandalszori; toe straps for Japanese style wooden clogs; togas; tongue for shoes and boots; top hats; toques; track and field shoes; track jackets; track pants; track shoes; track suits; training shoes; training suits; trench coats; trouser braces; trouser socks; trouser straps; trousers; trousers for sweating; trousers of leather; tube tops; tunics; turbans; turtleneck sweaters; tutus; tuxedo belts; tuxedos; underclothing; undergarments; underpants; undershirts; undershirts for kimonos [juban]; undershirts for kimonos [koshimaki]; underskirts; underwear; uniforms for medical personnel; uppers for Japanese style sandals; uppers of woven rattan for Japanese style sandals; ushankas [fur hats]; valenki [felted boots]; veils; vests; visor caps; visors for athletic use; volleyball jerseys; volleyball shoes; waist belts; waist strings for kimonos [koshihimo]; waistbands; waistcoats; walking shoes; walking shorts; waraji [Japanese footwear made of rice straw]; warm-up pants; warm-up suits; warm-up tops; waterproof jackets; waterproof jackets and pants; waterproof pants; waterskiing suits; wedding dresses; wedding gowns; wellies; wellington boots; welts for footwear; welts for shoes; wet suits; wet suits for surfing; wet suits for water-skiing; wet suits for water-skiing and sub-aqua; wetsuits for water-skiing; wetsuits for windsurfing; wimples; wind coats; wind resistant jackets; wind vests; wind-jackets; wind-resistant jackets; wind-resistant vests; windcheaters; windjammers for motorcycles; winter boots; winter coats; winter gloves; winter jackets; women's blouses; women's ceremonial dresses; women's foldable slippers; women's lingerie; women's shirts; women's shoes; women's socks; women's sportswear; women's suits; women's underwear; wooden main bodies of Japanese style wooden clogs; wooden shoes; wooden supports of Japanese style wooden clogs; woolen tights; woollen socks; woolly hats; work boots; work shoes; work shoes and boots; working overalls; woven rattan uppers for Japanese-style sandals; woven shirts; woven tops; woven underwear; wrap belts for kimonos [datemaki]; wrist bands; wristbands; yoga pants; yoga shoes; zoot suits; zori [Japanese-style sandals]

Application Number 2,047,797
Language of Application English

Filing Date 2020-08-26

APPLICANT DETAILS

Applicant

JONARD INDUSTRIES CORP.
200 Clearbrook Road #128
Elmsford, NY 10523
UNITED STATES OF AMERICA

TRADEMARK DETAILS

JONARD

Trademark Type

Standard Characters

Goods

Class 08

adjustable spanners; adjustable wrenches; all purpose scissors; awls; axes; bench vices; bench vises; bill-hooks; billhooks; bit drivers for hand tools; bits for hand drills; blades for electric razors; blades for hand saws; blades for hand-operated planes; bolt cutters; border shears; bow saws; box cutters; box spanners; box wrenches; broadaxes; carpenters' augers; carpenters' clamps; carpenters' pincers; carpet knives; carving knives; cattle shearers; chisels; clamping bushings; clamps for carpenters or coopers; claw hammers; cleavers; crimping iron hand tools; crimping pliers; crosscut saw blades; crow bars; crowbars; cutlery; cutters for wine bottle foil; cutting guides for use with hand-operated tools; cutting pliers; daggers; die wrenches; dies for use with hand operated tools; dies for use with hand-operated tools; disposable knives; diving knives; dog clippers; drill bits for hand drills; embroidery scissors; emergency hammers; farriers' knives; filleting knives; fish knives; fish scalers; fish slicing kitchen knives; fish tape for pulling cables; fish tapes; fish-skinning knives; fish-skinning pliers; fishing knives; fishing line cutters; fishing pliers; fishing scoops; fishing tackle pliers; fleshing knives; folding knives; frames for handsaws; garden hoes; garden picks; gardening scissors; gardening shears; gardening shears and scissors; gardening tools; gardening trowels; hack saws; hacksaw blades; hacksaws; hand cultivators; hand files; hand held cutting tools; hand hooks; hand jacks; hand operated hammers; hand operated lifting jacks; hand operated plumbing snakes; hand saws; hand taps; hand tool augers; hand tool punches; hand tools; hand tools for carving pumpkins; hand-held drills; hand-held hoes; hand-held reamers; hand-operated abrading tools; hand-operated bar cutters; hand-operated cattle prods; hand-operated chisels; hand-operated files; hand-operated hack saws; hand-operated hammers; hand-operated hand drills; hand-operated hand tools; hand-operated jig-saws; hand-operated jigsaws; hand-operated lifting jacks; hand-operated milling cutters; hand-operated motorcycle lifting jacks; hand-operated pipe cutters; hand-operated plumbing snakes; hand-operated post hole diggers; hand-operated riveting tools; hand-operated sanders; hand-operated saws; hand-operated scrapers for skinning animals; hand-operated scrapers for skinning fish; hand-operated sharpening tools and instruments; hand-operated shears; hand-operated slicers; hand-operated staple guns; hand-operated tampers; hand-operated tile cutters; hand-operated tillers; hand-operated tin snips; hand-operated tools for bending pipes; hand-operated tools for planting bulbs; hand-operated torque multipliers; hand-operated weed cutters; hand-operated weed diggers; hand-operated

wrenches; handsaws; hatchets; hex keys; hex wrenches; hobby knives; hunting knives; ice hammers; ice picks; ice scrapers; jack knives; jig saws; jig-saws; jigsaws; kitchen knives; kitchen knives for slicing fish; kitchen scissors; kitchen shears; knife sets; knife sharpeners; knife sheaths; knives for skinning animals; knives for skinning fish; machetes; mallets; mandrels; manual drills; manual ratchet wrenches; manual socket wrench; manually operated hand tools; masons' hammers; masons' trowels; meat claws; mechanics' tools; metal cutting saws; metal cutting scissors; metal vice jaws; metal vices; metal vise jaws; metal vises; metal-cutting saws; metal-cutting scissors; miter cutter; miter cutters being hand tools; miter sander; miter sanders being hand tools; miter vises being hand tools; monkey wrenches; mortise axes; mortise chisels; multi-purpose shears; multipurpose shears; nail punches; nail scissors; needle work scissors; needlework scissors; numbering punches; nut wrenches; oil filter wrenches; pickaxes; pickaxes and mattocks; pickhammers; pipe wrenches; plane irons; planes; planing blades; pliers; pliers for skinning animals; pliers for skinning fish; pocket knives; pocket shears; poultry scissors; poultry shears; pruning knives; pruning scissors; pry bars; punches being hand tools; punching dies; putty knives; ratchet handles; razor blades; razor knives; razors; razors and razor blades; sabers; sabres; safety razors; saw holders; saws for cutting branches; scaling knives; scissor blades; scissors; scissors for children; scissors for household use; scissors for kitchen use; scoring knives for veneer sheets; screw wrenches; screwdrivers; setting pliers; sewing scissors; sharpening rods; sharpening steels; sharpening stones; sharpening wheels for knives and blades; shears; shovels; sickles; sickles and scythes; spades; spading forks; spark wrenches; spears; spears for use in fishing; sport knives; staple guns; stone hammers; tailor's shears; tailors' shears; tap wrenches; taps being hand tools; throwing knives; tool aprons; tool belts; tool handles of plastic; torque wrenches; tree pruners; trowels; tweezers; utility knives; vice jaws; vices; vise jaws; vises; weed cutters; weeding hoes; weeding knives; wire crimpers; wire cutters; wire strippers; wool shears; woolen shears; wrenches

Application Number 2,047,822
Language of Application English

Filing Date 2020-08-26

APPLICANT DETAILS

Applicant

Xiaolei Wang
48 Pike Road
Oakville
ONTARIO
L6H6C3

TRADEMARK DETAILS

CHICKEN BOMBER

Trademark Type

Standard Characters

Disclaimer

The right to the exclusive use of the words The applicant disclaims the right to the exclusive use of the words CHICKEN and BOMBER apart from the trademark. is disclaimed apart from the trademark.

Goods

Class 29

(1) chicken; chicken breast fillets; chicken burger patties; chicken croquettes; chicken nuggets; chicken salad; chicken spreads; chicken stock; chicken wings; cod; codfish; french fries; fried chicken; fried meat; fried potatoes; hamburger patties; hash brown potatoes; milk shakes; onion rings; potato chips; prepared meat; preserved meat

Class 30

(2) apple pie; apple pies; asian noodles; bagels; biscuits; bread; bread and buns; bread and pastry; bread crumb; cakes; chocolate; chocolate chip cookies; chocolate cupcakes; chocolate mousses; coffee; coffee and tea; coffee based beverages; coffee beverages with milk; coffee-based beverages; cookies; doughnuts; gravy sauce; hamburger sandwiches; hot dog sandwiches; ice cream; ice cream bars; ice cream cones; ice cream sandwiches; ice-cream; iced coffee; ices and ice creams; instant coffee; instant noodles; sandwiches

Services

Class 35

(1) advice in the running of establishments as franchises; business management advisory services relating to franchising; offering technical assistance in the establishment and operation of restaurant franchises; online sales of food items; providing assistance in the field of business management within the framework of a franchise contract; restaurant management for others; retail sale of food; sales demonstrations of kitchen appliances; street vending of food; wholesale store services featuring cookware; wholesale store services featuring ice cream

Class 43

(2) carry-out restaurant services; carry-out restaurants; catering for the provision of food and beverages; catering in fast-food cafeterias; catering of food and drinks; catering services; catering services for company cafeterias; catering services for conference centres; catering services for educational establishments; catering services for hotels; catering services for schools; fast food and non-stop restaurant services; fast-food restaurants; fast-food snackbars; restaurant services; restaurant services featuring take-out services; restaurants; restaurants featuring home delivery; take-away fast food services; take-away restaurant services; take-out restaurant services; tourist restaurant services

Class 45

(3) awarding of licenses for franchising concepts; consultancy services relating to the legal aspects of franchising; granting of licences for franchise concepts; issuing licences for franchising concepts; legal advice relating to franchising; legal consultancy relating to franchising; licensing of franchising concepts; professional legal consultations relating to franchising; professional legal franchise consulting

Application Number 2,047,885
International Registration Number 1547346
Language of Application English

Filing Date 2019-07-31

APPLICANT AND AGENT DETAILS

Applicant

Racing Point UK Limited
Dadford Road, Silverstone
Northamptonshire NN12 8TJ
UNITED KINGDOM

Agent

CASSAN MACLEAN IP AGENCY INC.
190 O'CONNOR STREET, SUITE 710,
OTTAWA, ONTARIO, K2P2R3

TRADEMARK DETAILS

RacingPoint

Trademark Type

Standard Characters

Goods

Class 09

(1) Video game software and computer game software; downloadable computer graphics; downloadable wallpapers for computers and phones; cell phone covers; covers for tablet computers; laptop covers; leather cases for mobile phones; decorative magnets; spectacles and sunglasses; cases for spectacles and sunglasses; spectacle cords; straps for sunglasses; helmets for sports.

Class 14

(2) Jewellery, in particular bracelets, pendants, wristwatches and jewellery pins; key rings and key chains and charms therefor.

Class 16

(3) Stationery, in particular, paper pads, calendars, pens, color pens, pen sets, pen cases, fountain pens, pencils, ornaments for pencils, pen holders, sharpeners for pencils, erasers; printed matter, in particular photographs, posters, printed calendars, flags and pennants of paper; lanyards for holding badges made of paper.

Class 18

(4) Luggage, bags, wallets and other carriers, in particular rucksacks, bags for sports, key cases; luggage tags; umbrellas and parasols.

Class 21

(5) Drinking glasses; mugs; drinking bottles, in particular for sporting activities; dishes, cookware and containers for household and kitchen, in particular lunch boxes.

Class 24

(6) Flags and pennants of fabric or plastic.

Class 25

(7) Clothing, in particular jackets, coats, trousers, vests, pullovers, sweaters, hoodies, t-shirts, socks, underwear, pajamas, bathrobes, scarves, gloves, belts; headgear, namely caps, cap umbrellas and hats; footwear, in particular sports, training and casual shoes.

Class 28

(8) Toys and games, in particular board games, playing cards, puzzles, racing car games, toy cars; scale model cars; radio controlled toy model cars; toy figures.

Claims

Priority Filing Date: February 07, 2019, Country or Office: EUIPO (EU), Application No: 018020142 in association with the same kind of goods

Application Number 2,047,945
International Registration Number 1547223
Language of Application English

Filing Date 2020-04-07

APPLICANT AND AGENT DETAILS

Applicant

VINDEX LLC
535 Madison Avenue, 30th Floor
New York NY 10022
UNITED STATES OF AMERICA

Agent

CHRISTOPHER L. BENNETT
(DLA PIPER (CANADA) LLP), 2800 PARK
PLACE, 666 BARRARD STREET,
VANCOUVER, BRITISH COLUMBIA, V6C2Z7

TRADEMARK DETAILS

ESPORTS ENGINE

Trademark Type

Standard Characters

Disclaimer

The right to the exclusive use of the word ESPORTS is disclaimed apart from the trademark.

Services

Class 35

(1) Business consulting services in the fields of digital marketing and marketing strategy, social media campaigns, media roadmaps and strategies, and audience behavior and trends; production of advertising materials for others, namely, creating, developing, producing, and managing commercially produced videos in the nature of advertisements and promotional videos; business management for others of live video game competitions, trade show events, and product launches; event services, namely, business management of eSports events; providing on-line electronic registration services for users to register for online access to eSports events, tickets to in-person eSports events, and participation in eSports events; business management of event ticketing for others; advertising services for promoting eSports events of others; developing marketing strategies and marketing concepts for others; talent agency services, namely, talent recruiting services in the nature of talent casting in the entertainment and eSports industries; business advisory services in the field of eSports tournament ownership and management; accounting services; customer services, namely, responding to business inquiries and providing customer information for others in the field of eSports events; administration, billing and reconciliation of accounts on behalf of others.

Class 36

(2) Financial consulting services, namely, creating individual budgets and financial projections for others in the field of event production and management.

Class 38

(3) Streaming of digital media content, namely, music, movies, news, sports and eSports via the internet; wireless broadband communications services, namely, the broadband transmission of live broadcasts of sports and eSports competitions and tournaments and events; interactive broadcasting and communications services, namely, broadcasting internet streaming of programs in the field of sports, eSports competitions and tournaments, and events; streaming of digital

media content namely, music, movies, news, sports and eSports via the internet; broadcasting of audio and video via the internet featuring music, movies, news, sports and eSports.

Class 41

(4) Video production, namely, creating and producing internet streaming videos and commercially produced videos in the nature of videos produced for hire; conducting entertainment exhibitions in the nature of eSports events; organizing eSports activities and games, namely, organizing eSports competitions and tournaments; booking of seats for entertainment events; event services, namely, arranging, organizing, and conducting eSports events.

Class 42

(5) Computer services, namely, design and development of interactive media content in the nature of computer game software; designing live events, namely, design of sets and props for production of live video game competitions, trade show events, and product launches; graphic design services; computer site design; website design consultancy; graphic design of multimedia products, namely, promotional materials; video game production, namely, design and development of interactive media content in the nature of video games; hosting a web-based system and on-line portal for customers to participate in on-line gaming, operation and coordination of game tournaments, leagues and tours for recreational computer game playing purposes.

Class 45

(6) Licensing of intellectual property in the field of trademarks and copyrights; reviewing standards and practices to ensure regulatory compliance with professional eSports rules and regulations.

Claims

Priority Filing Date: October 28, 2019, Country or Office: UNITED STATES OF AMERICA, Application No: 88671269 in association with the same kind of services

Application Number 2,048,240
Language of Application English

Filing Date 2020-08-26

APPLICANT DETAILS

Applicant

Diva Collective Pty Ltd as Trustee for the PN
Family Trust
7 Martinique Way
Clear Island Waters, 4226
AUSTRALIA

TRADEMARK DETAILS

Goodbye Wrinkles

Trademark Type

Standard Characters

Goods

Class 03

cleansing milk for skin care; cloths or tissues impregnated with a skin cleanser; cosmetic creams for firming skin around eyes; cosmetic creams for skin care; cosmetic oils for the skin; cosmetic patches containing sunscreen and sun block for use on the skin; cosmetic preparations for dry skin during pregnancy; cosmetic preparations for skin renewal; cosmetic skin care lotions; cosmetic skin care preparations; cosmetic skin fresheners; cosmetic skin lotions; cosmetics; cosmetics for use on the skin; cream for whitening the skin; emulsions, gels and lotions for skin care; exfoliants for the skin; foot masks for skin care; hand masks for skin care; moisturising skin lotions; moisturizing skin lotions; non-medicated preparations for the care of skin; non-medicated skin care preparations; non-medicated skin creams; skin abrasives; skin care cosmetics; skin care creams; skin care lotions; skin care mousse; skin care preparations; skin clarifiers; skin cleansers; skin cleansing creams; skin cleansing foams; skin cleansing lotions; skin conditioners; skin conditioning creams for cosmetic purposes; skin creams; skin creams for cosmetic purposes; skin creams in liquid and solid form; skin emollients; skin emollients for cosmetic purposes; skin exfoliants; skin fresheners; skin gels for accelerating, enhancing or extending tans; skin lighteners; skin lightening creams; skin lotions; skin masks; skin masks for cosmetic purposes; skin moisturisers; skin moisturizer masks; skin moisturizers; skin moisturizing cream; skin moisturizing gel; skin scrub; skin soap; skin soaps; skin texturizers; skin toners; skin tonics; skin whitening creams; skin whitening preparations; tissues impregnated with a skin cleanser; wipes impregnated with a skin cleanser; wrinkle removing skin care preparations

Application Number 2,048,299
Language of Application English

Filing Date 2020-08-27

APPLICANT AND AGENT DETAILS

Applicant

RGA Shlossy LLC
801 Barton Springs Road
Austin
Texas 78704
UNITED STATES OF AMERICA

Agent

PILLAR IP, INC.
1661 Shauna Crescent, Greely, ONTARIO,
K4P1M8

TRADEMARK DETAILS

ENOVOE

Trademark Type

Standard Characters

Goods

Class 12

adhesive rubber patches for repairing inner tubes; adhesive rubber patches for repairing tubes or tires; aerial conveyors; aero-dynamic fairings for vehicles; aeroplane towing vehicles; aeroplanes; agricultural tractors; air bags for automobiles; air balloons; air cushion vehicles; air pumps for automobiles; air pumps for bicycles; air pumps for motorcycles; air pumps for two-wheeled motor vehicles and bicycles; air pumps of automobiles; air pumps of two-wheeled motor vehicles; air springs for vehicle suspension components for cushioning driver's seats and cabs; air turbines for land vehicles; air-cushion vehicles; airbags for vehicles; aircraft; aircraft carriers; aircraft fuselages; aircraft landing gear; aircraft landing gear wheels; aircraft propellers; airplane landing gear wheels; airplane propellers; airplane seats; airplane spinners; airplanes; airships; all-terrain vehicles; ambulances; amphibious airplanes; amphibious vehicles; anti-skid chains; anti-skid chains for vehicle tires; anti-skid chains for vehicles; anti-skid studs for vehicle tires; anti-skid textile covers for tires; anti-theft alarms for vehicles; anti-theft devices for motor cars; anti-theft locks for use on automobile steering wheels; anti-theft warning apparatus for motor cars; arm rests for vehicles; armored vehicles; armoured bodies for vehicles; armoured cars; armoured land vehicles; armoured vehicles; ashtrays for automobiles; autogyros; automatic gearboxes for land vehicles; automatic guided vehicles; automatically guided driverless material handling tractors; automatically guided material handling trucks; automobile bodies; automobile bumpers; automobile chains; automobile chassis; automobile door handles; automobile engines; automobile hoods; automobile roof containers; automobile roof racks; automobile seat cushions; automobile ski racks; automobile spare wheel holders; automobile sunroofs; automobile suspension spindle; automobile suspension spindles; automobile tires; automobile tyres; automobile windscreens; automobile windshield sunshades; automobile windshields; automobiles; automobiles for the physically handicapped and those of reduced mobility; automotive interior trim; automotive shock absorbing springs; automotive suspension springs; autonomous underwater vehicles for seabed inspections; axle bearings for motor vehicles; axle boxes for rail cars; axle journals; axles and cardan shaft for motor vehicles; axles for air suspension systems in vehicles; axles for land vehicles; baby buggy bumpers; baby carriages; baby prams; baby strollers; bags adapted for pushchairs; bags adapted for strollers; balance weights for vehicle wheels; band brakes for land vehicles; bands for wheel

hubs; barges; baskets adapted for bicycles; bellows for articulated buses; bells for motorcycles; belt pulleys for land vehicles; bicycle bells; bicycle bottom bracket spindle; bicycle brake lever grips; bicycle brakes; bicycle carriers; bicycle chains; bicycle cranks; bicycle frames; bicycle frames and bicycle handlebar grips; bicycle handle bars; bicycle handlebar grips; bicycle handlebars; bicycle handles; bicycle horns; bicycle kickstands; bicycle motors; bicycle mudguards; bicycle parts; bicycle pedals; bicycle pumps; bicycle rims; bicycle saddles; bicycle seats; bicycle spokes; bicycle stands; bicycle tires; bicycle trailers; bicycle trailers [riyahkah]; bicycle tyres; bicycle wheel hubs; bicycle wheel rims; bicycle wheel spokes; bicycle wheels; bicycle wheels, rims and structural parts therefor; bicycles; bikes; block brakes for land vehicles; block brakes for machines; boat building kits; boat bumpers; boat canopies; boat chocks; boat davits; boat fenders; boat hooks; boat propellers; boat rigs; boat tillers; boat trailers; boat-hooks; boats; bodies for railway cars; bodies for vehicles; body panels for vehicles; bogies for railway cars; booms for boats; brake blocks; brake blocks for land vehicles; brake cylinder repair kits; brake cylinders; brake discs; brake discs for vehicles; brake disks; brake drums; brake drums for vehicles; brake facings; brake facings for vehicles; brake levers; brake linings; brake linings for land vehicles; brake linings for motor cars; brake linings for vehicles; brake pads for automobiles; brake pads for land vehicles; brake pucks; brake segments for motor cars; brake segments for vehicles; brake shoes; brake shoes for land vehicles; brake shoes for motor cars; brake shoes for vehicles; brake systems for motor vehicles; brakes for aircrafts; brakes for motor cars; brakes for motor vehicles; brakes for vehicles; braking systems for motor vehicles and parts thereof; buffers for railway rolling stock; bumpers for automobiles; buses; cable cars; cable ships; camera drones; camper vans; camping trailers; canoe paddles; canoes; caps for vehicle fuel tanks; caps for wheel rims; car doors; car horns; car seat covers; car seat harnesses; car suspension spindle; car suspension spindles; car windows; car-top luggage carriers; caravans; cargo ships; cargo trailers; cars; cars for cable transport installations; cement mixers; chain guards for bicycles; chains for motor cars; chair lifts; chairlifts; chassis for automobiles; chassis for motor vehicles; chassis for railway cars; child car seats; child safety harnesses for vehicle seats; child safety restraints for bicycles; child safety restraints for vehicle seats; children's car seats; children's safety seats for cars; children's safety seats for vehicles; cigar lighters for automobiles; civilian drones; clutch mechanisms for motor cars; clutches for motor vehicles; collapsible bicycles; concrete mixing vehicles; cone brakes for land vehicles; construction tractors; convertible tops for vehicles; covers for baby carriages; covers for vehicle steering wheels; cranks for cycles; davits for boats; delivery bicycles; delivery drones; delivery tricycles; diesel engines for land vehicles; diesel motors for land vehicles; dining cars; direction indicators for bicycles; direction signals for automobiles; direction signals for vehicles; directional signals for vehicles; dirigible balloons; disc brakes for land vehicles; disengaging gear for boats; dog guards for use in vehicles; dog racing sleds; dollies; doors for automobiles; doors for railway cars; doors for vehicles; dredgers; dress guards for bicycles; drive belts; drive gears; drive-chain guards for two-wheeled motor vehicles; driverless cars; driverless material handling trucks; driving chains for land vehicles; driving motors for land vehicles; dump cars; dump carts; dump trucks; dune buggy steering brakes; ejector seats for aircraft; electric bicycles; electric cars; electric drives for vehicles; electric locomotives; electric motors for motor cars; electric railway cars; electric reversing alarms for vehicles; electric scooters; electric steering gears for vessels; electrical anti-theft installations for vehicles; electrically powered aircraft; electrically powered buses; electrically powered motor scooters; electrically powered motor vehicles; engine mounts for land vehicles; engines for land vehicles; fenders for ships; ferry boats; fishing boats; fishing trolleys; fitted covers for boats; fitted covers for vehicle steering wheels; fitted footmuffs for baby carriages; fitted footmuffs for prams; fitted footmuffs for pushchairs; fitted footmuffs for strollers; fitted motorcycle covers; fitted perambulator covers; fitted pushchair mosquito nets; fitted stroller mosquito nets; fitted vehicle covers for automobiles; fitted vehicle seat covers; flanges for railway

wheel tires; flanges for railway wheel tyres; flanges of railway wheel tires; folding bikes; fork lift trucks; fork tines for forklifts; forklift trucks; frames for bicycles; frames for luggage carriers; frames for motorcycles; freewheels for bicycles; freewheels for motorcycles; front forks for bicycles; front forks for cycles; front forks for forklifts; front forks for motorcycles; front forks for snowmobiles; front forks for two-wheeled vehicles; fuel tanks; fuel tanks for aircraft; funicular railcars; funiculars; funnels for locomotives; funnels for ships; fuselages of aircraft; garbage trucks; garden tractors; garden tractors for transport; gas turbines for land vehicles; gasoline engines for land vehicles; gear boxes for land vehicles; gear lever knobs; gear lever knobs for vehicles; gear shifts; gear wheels; gear wheels for land vehicles; gearboxes; gearboxes for land vehicles; gearboxes for motor cars; gears for bicycles; glider aircraft; gliders; go-carts; go-kart transport trucks; go-karts; golf carts; grocery carts; ground effect vehicles; hand trucks; handbrake knobs; handbrake knobs for vehicles; handle bars for bicycles; handle bars for motorcycles; handlebar controls for mopeds; handlebar grips for bicycles; handlebar grips for motorcycles; handlebars; handlebars of two-wheeled motor vehicles or bicycles; handling carts; hatch boards; head restraints for vehicles; head rests for seats for motor cars; head-rests for vehicle seats; headlight wipers; hearses; heel guards for motorcyclists; helicams; helicopters; hoods for baby carriages; hoods for vehicle engines; hoods for vehicles; horns for motor cars; horns for motor vehicles; horse carriages; horse drawn carriages; horse trailers; horse-drawn sleighs; hose carts; hospital carts; hospital carts for dispensing medication; hot air balloons; house boats; house trailers; hovercraft; hub caps; hubs for bicycle wheels; hubs for motorcycle wheels; hubs for vehicle wheels; hybrid cars; hydraulic circuits for motor cars; hydraulic circuits for vehicles; hydraulic rim brakes; hydraulic torque converters for land vehicles; hydraulic turbines for land vehicles; hydrofoils; hydroplanes; idling pulleys for land vehicles; inclined ways for boats; inflatable air bags for use in vehicles for the prevention of injury in accidents; inner tubes for aircraft tires; inner tubes for aircraft wheel tires; inner tubes for automobile tires; inner tubes for bicycle tires; inner tubes for bicycle tyres; inner tubes for bicycles; inner tubes for motorcycle tires; inner tubes for pneumatic tires; inner tubes for pneumatic tyres; inner tubes for the wheels of forestry vehicles; inner tubes for tires; inner tubes for two-wheeled motor vehicles; internal combustion engines for land vehicles; internal combustion engines for motor vehicles; internal combustion locomotives; internal combustion railcars; Japanese flat-bottomed rowboats [tenmasen]; jet aircraft; kayak paddles; kayaks; kick sledges; kickstands; ladle carriages; ladle cars; landing gear wheels for aircraft; landing gear wheels of aircraft; license plate holders; light aircraft; light lorries; light trucks; locomotives; lorries for mines; lug nuts for vehicle wheels; luggage carriers for automobiles; luggage carriers for vehicles; luggage nets for vehicles; luggage racks fitted to the bonnet; luggage racks for bicycles; luggage racks for motor cars; luggage racks for motorcycles; luggage trucks; main brake cylinders; manual wheelchairs; masts for boats; mechanics' creepers; military drones; mine cars; mine cart wheels; mine-car pullers; mine-car pushers; mini-bikes; minibuses; minivans; mobile home caravans; mobility scooters; mopeds; motor buses; motor car convertible tops; motor car doors; motor car seats; motor car windows; motor cars; motor cars for transport on land; motor coaches; motor homes; motor racing cars; motor scooters; motor vehicle engines; motor vehicle hood scoops; motor vehicle mudguards; motorboats; motorcycle chains; motorcycle drive chains; motorcycle engines; motorcycle foot pegs; motorcycle frames; motorcycle grip tape; motorcycle handlebars; motorcycle kickstands; motorcycle saddlebags; motorcycle saddles; motorcycle sidecars; motorcycle tires; motorcycles; motorcycles for motocross; motorised wheelchairs for the disabled and those with mobility difficulties; motorized bicycles; motorized golf trolleys; motorized wheelchairs; mountain bicycles; moving vans; mudguards; mudguards for automobiles; mudguards for bicycles; mudguards for motorcycles; mudguards for two-wheeled motor vehicles; mudguards of two-wheeled motor vehicles or bicycles; non-motorized push scooters; oarlocks; oars; ocean kayak; omnibuses; outriggers for watercraft; padding for infant car seats; paddles for canoes; panniers

adapted for cycles; panniers adapted for motorcycles; parachute harnesses; parachutes; parachutes for arresting the motion of vehicles; parachutes for sky-diving; pedals for motorcycles; pet strollers; petrol tank caps for motor cars; photography drones; pickup trucks; pilot ejector seats; platform trucks; pneumatic tires; pneumatic tyres; pneumatic tyres and inner tubes for motorcycles; pontoon boats; pontoons; portholes; portholes for vessels; prams; propeller airplanes; protective liners for cargo area of vehicles; pumps for bicycle tires; pumps for bicycle tyres; push chairs; push scooters; pushchair covers; pushchair hoods; racing bicycles; racing cars; racing motor cars; rail cars; railcar suspension spindle; railway car wheels; railway carriages; railway cars; railway couplings; railway freight cars; railway passenger cars; railway rolling stock; rear view mirrors; rear wheel sprockets; rearview mirrors; rearview mirrors for automobiles; rearview mirrors of automobiles; reduction gears for land vehicles; refrigerated railroad car; refrigerated railway wagons; refrigerated trailers; repair outfits for inner tubes; reversing alarms for vehicles; reversing gears for land vehicles; rickshaws; rims for bicycle wheels; road racing bicycles; robotic cars; rocket thrusters; roll cage trolleys; roller bearings for motor vehicles; roller chains for forklifts; roller chains for land vehicles; rolling stock for funicular railways; rolling stock for railways; roof bars for vehicles; roof boxes for vehicles; roof racks for vehicles; rowboats; rowlocks; rubbish trucks; rudders for vessels; sack-barrows; saddle covers for bicycles; saddle covers for motorcycles; saddlebags adapted for bicycles; saddles for bicycles; saddles for motorcycles; safety belts for vehicle seats; safety belts for vehicles for motor cars; safety seats for children for motor cars; safety seats for infants and children for vehicles; sailboats; sailing vessels; sailplanes; screw propellers for vessels; screw-propellers; screw-propellers for boats; sculls; seaplanes; seat belt buckles; seat belts; seat covers for vehicles; seat safety harnesses for motor cars; seats for automobiles; seats for railway cars; security alarms for vehicles; security harness for vehicle seats; self-balancing boards; self-balancing electric scooters; self-balancing electric unicycles; self-balancing scooters; self-driving cars; self-generating electric locomotives; self-propelled electric platform truck; semi-tractor trailers; semi-trailer; semi-trailer trucks; shaft couplings for land vehicles; shift boots for motor vehicles; ship ballast tanks; ship hulls; ships; ships' hulls; ships' steering gears; shock absorbers for automobiles; shock absorbers for bicycles; shock absorbers for cars; shock absorbers for motor vehicles; shock absorbing springs for motor cars; shock absorbing springs for vehicles; shopping carts; shopping trolleys; side view mirrors for vehicles; ski carriers for automobiles; ski carriers for cars; ski carriers for motor cars; ski carriers for vehicles; ski lifts; ski racks; ski racks for motor cars; skiffs; sleeping berths for vehicles; sleeping cars; small wagons for children; snow chains; snowmobiles; solid tires for vehicle wheels; solid tyres for vehicle wheels; space vehicles; spare tire carriers for vehicles; spare tire covers; spare tyre covers; spare wheel covers; spars for ships; speed change gears for land vehicles; spikes for tires; spikes for tyres; spinnaker poles; spoilers for airplanes; spoilers for automotive vehicles; spoilers for motor vehicles; spoilers for vehicles; spoke clips for wheels; spokes for automobiles; spokes for bicycle wheels; spokes for bicycles; spokes for motorcycles; spokes for two-wheeled motor vehicles; sport utility vehicles; sports cars; sprinkling trucks; steam locomotives; steam steering gears and rudders for vessels; steam steering gears for vessels; steam turbines; steam turbines for land vehicles; steel hatch covers for vessels; steering gears and rudders for vessels; steering gears for ships; steering wheel covers; steering wheel covers for automobiles; steering wheels; steering wheels for automobiles; steering wheels for cars; steering wheels for vehicles; steering wheels for vessels; stern oars; stroller covers; stroller hoods; strollers; structural parts for automobiles; sun blinds for automobiles; sun shields and visors for motor cars; suspension arms for cable cars; suspension shock absorbers for vehicles; suspension springs for motor cars; suspension systems for motor vehicles; t bars for ski lifts; tandem bicycles; tilt rotor aircraft; tilt trucks; tilting-carts; tipping bodies for lorries; tipping bodies for trucks; tire inflators; tire mousse inserts; tire patches; tires; tires for aircraft landing gear wheels; tires for automobiles; tires for

bicycles; tires for children's' bicycles; tires for landing gear wheels for aircraft; tires for two-wheeled motor vehicles; tires for two-wheeled motor vehicles or bicycles; tires for wheels of aircraft; torque converters for motor cars; torsion bars for motor cars; touring bicycles; tow bars; tow bars for trailers; tow hooks; tow trucks; tow-bars; traction engines; tractor saddles; tractor steering brakes; tractor trailers; tractors; trailer couplings; trailer hitches; trailer hitches for vehicles; trailer wheels; trailers for transporting bicycles; train carriages; tramcars; transmission belts for land vehicles; transmission chains for land vehicles; transmission mechanisms for land vehicles; transmission rebuild kits for land vehicles; transmission shafts for land vehicles; transmissions for land vehicles; transmissions for motor vehicles; travel trailers; treads for retreading tires; treads for retreading tires for civil engineering vehicles; treads for retreading tyres; treads for retreading tyres for forestry vehicles; treads for retreading tyres for vehicles used in the civil engineering industry; tricycles; trolley buses; truck bodies; trucks; tubeless tires for bicycles; tubeless tyres for bicycles; tubular tires; tubular tyres; tug boats; turbines for locomotives; turbo-jet airplanes; turbo-prop airplanes; turbojet engines for land vehicles; turn signals for vehicles; two-wheeled trolleys; tyre mousse inserts; tyres and inner tubes for the wheels of forestry vehicles; tyres for agricultural vehicles; tyres for aircraft; tyres for buses; tyres for commercial vehicles; tyres for trucks; tyres for two-wheeled vehicles; undercarriages for vehicles; undercarriages of railway cars; unmanned aerial vehicles (UAVs); upholstery for vehicles; valves for vehicle tires; valves for vehicle tyres; vans; vehicle alarms; vehicle bodies; vehicle bonnet pins; vehicle brake discs; vehicle brake pads; vehicle bumpers; vehicle chassis; vehicle covers; vehicle hood pins; vehicle hoods; vehicle joysticks; vehicle luggage carriers; vehicle roof bars; vehicle roof boxes; vehicle running boards; vehicle seats; vehicle suspension springs; vehicle wheel hubs; vehicle wheel rims; vehicle windshield sunshades; vessels in the form of boats and ships; waggons; wagons; warning horns for automobiles; warning horns for motorcycles; water bikes; wheel arch extensions; wheel bearings for motor vehicles; wheel hubs of two-wheeled motor vehicles or bicycles; wheel rims for automobiles; wheel rims for motor cars; wheel rims for motor vehicles; wheel rims of two-wheeled motor vehicles or bicycles; wheel sprockets; wheelbarrows; wheelchairs; wheels for automobiles; wheels for motor vehicle; wheels for motorcycles; wheels of automobiles; wheels of railway cars; windows for vehicles; windscreen wipers; windscreen wipers for automobiles; windscreen wipers for motor cars; windscreens; windscreens for motor cars; windscreens for vehicles; windshield wiper blades; windshield wipers; windshields; wings for aircraft; wreckers for transport; yachts

Application Number 2,048,315
Language of Application English

Filing Date 2020-08-27

APPLICANT DETAILS

Applicant

STP Pharmaceutical Corp
1507 Bramble Lane
Coquitlam
BRITISH COLUMBIA
V3E2S7

TRADEMARK DETAILS

STP Pharmaceutical Corp

Trademark Type

Standard Characters

Goods

Class 01

(1) proteins for use in the manufacture of food supplements; vitamins for use in the manufacture of food supplements

Class 05

(2) amino acid dietary supplements; beta carotene supplements; botanical supplements for general health and well-being; calcium supplements; casein dietary supplements; dietary fibre for use as an ingredient in the manufacture of dietary supplements; dietary supplements consisting of amino acids; dietary supplements consisting of trace elements; dietary supplements for controlling cholesterol; dietary supplements for general health and well-being; dietary supplements for promoting weight loss; flaxseed dietary supplements; fodder supplements for veterinary purposes; food supplements consisting of amino acids; food supplements consisting of trace elements; glucose dietary supplements for animals; herbal and dietary supplements to aid in milk production in lactating animals; herbal supplements for general health and well-being; herbal supplements for the promotion of healthy liver function; herbal supplements for the treatment of arthritis; herbal supplements for the treatment of cancer; herbal supplements for the treatment of cardiovascular diseases; herbal supplements for the treatment of dental and oral diseases; herbal supplements for the treatment of headaches; herbal supplements for the treatment of infectious diseases, namely, urinary tract infections; herbal supplements for the treatment of inflammatory diseases, namely inflammatory bowel diseases and inflammatory connective tissue diseases; herbal supplements for the treatment of the musculoskeletal system, namely, connective tissue diseases, cartilage injuries; herbal supplements for the treatment of the respiratory system; herbal supplements for use in dermatology, namely, dermatitis, eczema, psoriasis; lecithin dietary supplements; liquid vitamin supplements; mineral dietary supplements for animals; mineral supplements; nutritional supplements for building body mass; nutritional supplements for general health and well-being; pollen dietary supplements; soy protein dietary supplements; vitamin and mineral dietary supplements; vitamin and mineral supplements; vitamin and mineral supplements

for pets; vitamin supplement patches; vitamin supplements; vitamin supplements in tablet form for making effervescent beverages when added to water; wheat dietary supplements; yeast dietary supplements; yeast dietary supplements for animals; zinc dietary supplements

Services**Class 44**

providing information about dietary supplements and nutrition

Application Number 2,048,354
Language of Application English

Filing Date 2020-08-27

APPLICANT DETAILS

Applicant

NIKBAL GEMS CORPORATION
60-7181 YONGE STREET
THORNHILL
ONTARIO
L3T0C7

TRADEMARK DETAILS

BOLANDIAN JEWELLERY

Trademark Type

Standard Characters

Goods

Class 14

agate jewellery; agates; alarm clocks; alloys of precious metal; alloys of precious metals; amulets; amulets being jewellery; ankle bracelets; ankle chains; anklet jewellery; artificial gemstones; atomic clocks; automatic watches; automobile clocks; badges of precious metal; badges of precious metals; bands for watches; bands for wristwatches; bangle bracelets; bangles; beads for making jewellery; beads for making jewelry; beads for use in the manufacture of jewellery; beads for use in the manufacture of jewelry; body-piercing rings; body-piercing studs; bonnet pins; bottle caps of precious metals; boxes for timepieces; boxes of precious metal; boxes of precious metals; bracelet charms; bracelets; bracelets for watches; bracelets for wristwatches; bracelets of precious metal; bronze jewellery; buckles for watch bands; buckles for watch straps; buckles for watchstraps; busts of precious metal; busts of precious metals; cabochons; cabochons for making jewellery; cake toppers of precious metal; cases adapted to contain items of jewellery; cases for clock and watch-making; cases for clock- and watchmaking; cases for clocks and watches; cases for timepieces; cases for watches and clocks; caskets for clocks and jewels; chains of precious metal for bracelets; chalcedony; chaplets; charity bracelets; charms for bracelets; charms for jewellery; charms for jewelry; charms for key chains; charms for key rings; charms for necklaces; charms in precious metals or coated therewith; children's jewellery; chokers; chronometers; chronoscopes; clasps for jewellery; clasps for jewelry; clip earrings; clip-on earrings; clock and watch hands; clock and watchmaking pendulums; clock cabinets; clock cases; clock cases not of precious metal; clock cases of precious metal; clock cases of precious metal or coated therewith; clock dials; clock faces; clock hands; clock housings; clock movements; clock springs; clock-radios; clockmaking pendulums; clocks; clocks and parts therefor; clocks and watches; clocks and watches for pigeon fanciers; clocks and watches for pigeon-fanciers; clocks for motor vehicles; clocks incorporating radios; clockworks; cloisonné jewellery; cloisonné jewelry; cloisonné pins; closures for necklaces; coins; collectable coins; collectable monetary coin sets; commemorative boxes of precious metal; commemorative coins; commemorative medals; commemorative shields of precious metal; commemorative statuary cups made of precious metal; control clocks; copper tokens; costume jewellery; crystal jewellery; cuff links; cuff links and tie clips; cuff links made of porcelain; cuff links made of precious metal; cuff links of precious metal; cufflinks; cultured pearls;

custom jewellery; custom jewelry; cut diamonds; decorative boxes made of precious metal; decorative boxes of precious metal; desk clocks; desktop statuary made of precious metal; diadems; dials for clock- and watchmaking; dials for clock-and-watch-making; dials for clocks; dials for watches; diamond jewellery; diamonds; digital clocks; digital watches; diving watches; drawer handles of precious metal; drawer pulls of precious metal; dress watches; ear clips; ear studs; earring posts; earrings; earrings of precious metal; emeralds; engagement rings; eternity rings; faces for clocks; faces for watches; fancy key chains of precious metal; fancy key rings of precious metal; fancy keyrings of precious metals; figures of precious metal; figurines made from gold; figurines made from silver; figurines made of imitation gold; figurines of precious metal; finger rings; fitted jewelry pouches; floor clocks; friendship bracelets; friendship rings; gems; gemstone; gemstones; glass jewellery; gold; gold alloy ingots; gold alloys; gold and its alloys; gold bracelets; gold bullion; gold earrings; gold figurines; gold ingots; gold jewellery; gold necklaces; gold rings; gold thread jewellery; gold thread jewelry; gold watches; gold-plated bracelets; gold-plated earrings; gold-plated necklaces; gold-plated rings; grave markers of precious metal; hat jewellery; hat jewelry; hat ornaments of precious metal; identity plates of precious metal being jewellery; imitation jewellery; imitation leather key chains; imitation leather key rings; imitation pearls; imitation stones for making jewellery; ingots of precious metal; ingots of precious metals; insignias of precious metal; iridium; iridium alloys; iridium and its alloys; ivory jewellery; ivory jewelry; jade; jade jewellery; jewel boxes; jewel cases; jewel cases of precious metal; jewel chains; jewel pendants; jewellery; jewellery and imitation jewellery; jewellery and precious stones; jewellery and watches; jewellery boxes; jewellery boxes of leather; jewellery boxes of metal; jewellery boxes of precious metal; jewellery bracelets; jewellery brooches; jewellery cases; jewellery cases of precious metal; jewellery caskets; jewellery caskets of precious metal; jewellery chain of precious metal for bracelets; jewellery chains; jewellery chains of precious metal for bracelets; jewellery charms; jewellery clasps; jewellery fashioned from bronze; jewellery findings; jewellery for children; jewellery for men; jewellery for the head; jewellery hat pins; jewellery lockets; jewellery made of crystal; jewellery made of glass; jewellery made of plastics; jewellery of yellow amber; jewellery pearls; jewellery pins; jewellery plated with precious metals; jewellery presentation boxes; jewellery rings; jewellery rolls; jewellery rolls for storage; jewellery rolls for travel; jewellery watches; jewelry; jewelry and imitation jewelry; jewelry boxes; jewelry brooches; jewelry cases; jewelry cases of precious metal; jewelry caskets of precious metal; jewelry chains; jewelry charms; jewelry clips for adapting pierced earrings to clip-on earrings; jewelry dishes; jewelry findings; jewelry for the head; jewelry hat pins; jewelry of yellow amber; jewelry organizer cases; jewelry organizer rolls for travel; jewelry rings; jewelry rolls for storage; jewelry rolls for travel; jewelry stickpins; jewelry watches; jewels; key chain tags; key chain tags of plastic; key chains; key chains of common metal; key chains of imitation leather; key chains of leather; key chains of metal; key chains of plastic; key chains of precious metal; key chains with trinkets or decorative fobs; key fobs made of common metal; key fobs made of imitation leather; key fobs made of leather; key fobs made of metal; key fobs of common metal; key fobs of imitation leather; key fobs of leather; key fobs of precious metal; key rings; key rings of common metal; key rings of imitation leather; key rings of leather; key rings of metal; key rings of plastic; key rings of precious metal; key rings with trinkets or decorative fobs; key tags; key tags of plastic; keyrings of common metal; lanyards for holding badges of precious metals; lanyards for holding keys; lapel badges of precious metal; lapel pins; leather jewellery boxes; leather key chains; leather key fobs; leather key rings; leather watch bands; leather watch straps; lockets; master clocks; mechanical and automatic watches; mechanical watches; medallions; medals; medals and medallions; medals coated with precious metals; meditation stones; men's jewellery; men's watches; metal jewellery; metal key chains; metal key fobs; metal key rings; metal tokens for use in vending or game machines; metal tokens used for mass transit; metal watch bands; metal watch straps; misbaha [prayer beads]; model figures

ornaments of precious metal; monetary coin sets for collecting purposes; movements for clocks and watches; movements for timepieces; movements for watches and clocks; musical jewellery boxes; musical jewelry boxes; natural pearls; neck chains; necklaces; necklaces of precious metal; necktie fasteners; olivine; omamori [lucky charms]; opal; opals; ornamental hat pins; ornamental pins; ornamental pins made of precious metal; oscillators for clocks; oscillators for timepieces; oscillators for watches; osmium; osmium alloys; osmium and its alloys; palladium; palladium alloys; palladium and its alloys; paste jewellery; pearl jewellery; pearls; pearls made of ambroid; pendants; pendulums for clocks; pendulums for watches; peridot; pin badges of precious metal; pins being jewellery; plastic jewellery; plastic key chain tags; plastic key tags; plastic watch bands; plastic watch straps; platinum; platinum alloy ingots; platinum alloys; platinum and its alloys; platinum ingots; platinum jewellery; platinum rings; platinum watches; pocket watches; precious and semi-precious stones; precious gemstones; precious metal tips for bolo ties; precious metal trophies; precious metal trophy columns; precious metals; precious metals and alloys thereof; precious metals and their alloys; precious stones; presentation boxes for jewellery; presentation boxes for jewelry; presentation boxes for watches; prize cups of precious metal; processed precious metals; promotional key chains; real and imitation jewellery; religious statues of precious metal; retractable key chains; retractable key rings; rhodium; rhodium alloys; rhodium and its alloys; rings being jewellery; rings coated with precious metals; rings of precious metal; rosaries; rough diamond; rough precious stones; rubies; ruby; ruthenium; ruthenium alloys; ruthenium and its alloys; sapphire; sapphires; sardonyx; scarf clips being jewellery; sculptures made of precious metal; sculptures of precious metal; semi-precious and precious stones; semi-precious gemstones; semi-precious metals; semi-precious stones; semi-processed precious metals; semi-worked gold; semi-wrought precious stones and their imitations; shoe jewellery; shoe jewelry; shoe ornaments of precious metal; silver; silver alloy ingots; silver alloys; silver and its alloys; silver bracelets; silver bullion; silver earrings; silver figurines; silver ingots; silver jewellery; silver jewelry; silver necklaces; silver rings; silver watches; silver works of art; silver-plated bracelets; silver-plated earrings; silver-plated necklaces; silver-plated rings; slides for bolo ties; small clocks; small jewellery boxes; small jewellery boxes of precious metal; small jewellery boxes of precious metals; small jewelry boxes; spinel; spinels; split rings of precious metal for keys; sports watches; springs for wall clocks; spun silver; statues of precious metal; statues of precious metal and their alloys; statues of precious metal of religious icons; statues of precious metals; statuettes of precious metal; statuettes of precious metal and their alloys; sterling silver jewellery; stop watches; stopwatches; straps for watches; straps for wristwatches; sundials; synthetic precious stones; table clocks; tiaras; tie bars; tie bars of precious metal; tie clasps; tie clasps of precious metal; tie clips; tie clips of precious metal; tie pins; tie pins of precious metal; tie tacks; tie-pins of precious metal; tips of precious metal for bolo ties; toe rings; tombstones of precious metal; topaz; travel alarm clocks; travel clocks; trinket boxes; trinket rings; trophies coated with precious metal alloys; trophies coated with precious metals; trophies made of precious metal; trophies made of precious metal alloys; trophies made of precious metals; trophies of precious metal; trophies of precious metals; trophy columns of precious metal; unworked gold; unwrought agate; unwrought agate and sardonyx; unwrought and semi-wrought precious stones and their imitations; unwrought diamond; unwrought or beaten gold; unwrought or beaten silver; unwrought or semi-wrought jet; unwrought or semi-wrought precious metals; unwrought precious metals; unwrought precious stones; unwrought sardonyx; wall clocks; watch and clock springs; watch bands; watch bands and straps; watch boxes; watch bracelets; watch cases; watch cases of precious metal; watch cases of precious metal or coated therewith; watch chains; watch clasps; watch crowns; watch crystals; watch dials; watch faces; watch fobs; watch glasses; watch hands; watch movements; watch parts; watch pouches; watch presentation boxes; watch springs; watch straps; watch straps made of metal or leather or plastic; watch winders; watch winding buttons; watchbands; watches; watches and clocks; watches and

jewellery; watches and straps for watches; watches containing a game function; watches containing an electronic game function; watches for men; watches for outdoor use; watches for sporting use; watches for women; watches made of precious metals or coated therewith; watchmaking pendulums; watchstraps; watchstraps made of leather; watchstraps made of metal; watchstraps made of plastic; wedding bands; wedding rings; women's jewellery; women's jewelry; women's watches; wooden bead bracelets; wooden bead jewellery; wooden bead necklaces; wooden jewellery boxes; wooden jewelry boxes; works of art of precious metal; works of art of precious metals; wrist watches; wristwatch bands; wristwatch bracelets; wristwatch straps; wristwatches

Application Number 2,048,425
Language of Application English

Filing Date 2020-08-27

APPLICANT AND AGENT DETAILS

Applicant

Mini-Entreprises Bazinet Inc.
399 Imp Des Fougères
La Présentation
QUEBEC
J0H1B0

Agent

ANITA MAR
dba Trademark Angel , Suite 521, 6-2557
Dougall Avenue, Windsor, ONTARIO, N8X1T5

TRADEMARK DETAILS

Trademark Type

Design

Visual Representation



Goods

Class 07

(1) electrical coffee grinders

Class 21

(2) coffee mugs; non-electrical coffee grinders

Application Number 2,048,439
Language of Application English

Filing Date 2020-08-28

APPLICANT AND AGENT DETAILS

Applicant

Shenzhen Shengkeda Communication
Equipment Co. LTD
No. 1913, Building 2, Tongjian Building
Nanyuan Street, Futian District
Shenzhen, 518000
CHINA

Agent

YURI CHUMAK
c/o Dickinson Wright LLP, 199 Bay Street,
Suite 2200, Toronto, ONTARIO, M5L1G4

TRADEMARK DETAILS

Trademark Type

Design

Visual Representation

The logo for Meajose features the word "Meajose" in a lowercase, sans-serif font. The letter "M" is stylized with a diagonal slash through it, creating a unique graphic element.

Goods

Class 21

bakeware; baking mats; bread boards; cake decorating tips and tubes; cake molds; cookery molds; cookie cutters; cooking funnels; dinnerware; food storage containers; graters for kitchen use; mixing spoons; non-electric griddles; spatulas for kitchen use; vegetable dishes

Application Number 2,048,442
Language of Application English

Filing Date 2020-08-28

APPLICANT DETAILS

Applicant

Shenzhen Qunyi Cloud Intelligence
Technology Co., Ltd
Rm 407, Bldg 2,1970 Science & Technology
Park
Minzhi Community, Longhua Dist.
Shenzhen, Guangdong,
CHINA

TRADEMARK DETAILS

Trademark Type

Design

Visual Representation



Goods

Class 09

computer bags; hand-held personal computers; protective cases for tablet computers; stands adapted for tablet computers; tablet computer

Application Number 2,048,649
Language of Application English

Filing Date 2020-08-29

APPLICANT DETAILS

Applicant

Matthew Ballyk
158 Algonquin Ave
Hamilton
ONTARIO
L9G3C6

TRADEMARK DETAILS

SMALLS BREWING

Trademark Type

Standard Characters

Disclaimer

The applicant disclaims the right to the exclusive use of the word BREWING apart from the trademark.

Goods

Class 16

(1) adhesive labels; posters; stickers; posters made of paper

Class 18

(2) tote bags

Class 21

(3) beer glasses; beverage glassware; wine glasses

Class 25

(4) baseball caps; caps; hooded sweatshirts; sweaters; sweatshirts; t-shirts; baseball caps and hats; hats

Class 32

(5) alcohol-free beers; beer; beer, ale, lager, stout and porter; beers; low-alcohol beer; non-alcoholic beer; sparkling water; wheat beer; wheat beers

Services

Class 40

beer brewing services; brewing of beer; brewing of beer by microbreweries

Application Number 2,048,751
Language of Application English

Filing Date 2020-08-31

APPLICANT DETAILS

Applicant
Xiaolei Wang
48 Pike Road
Oakville
ONTARIO
L6H6C3

TRADEMARK DETAILS

Trademark Type
Design

Visual Representation



Disclaimer

The right to the exclusive use of the letters of C and B is disclaimed apart from the trademark.

Services

Class 43

(1) coffee and juice bar services; coffee and tea bars; coffee shop services; coffee shops; coffee-house and snack-bar services; coffee-house services; fast food and non-stop restaurant services; fast-food restaurants; fast-food snackbars; food and drink catering; food and drink catering for banquets; food and drink catering for cocktail parties; food and drink catering for institutions; hotel catering services; restaurant services; restaurant services featuring take-out services; restaurants; restaurants featuring home delivery; self service restaurants; self-service cafeteria services; self-service restaurant services; self-service restaurants; snack bar and canteen services; snack bar services; snack-bar services; snack-bars; take-away fast food services; take-away restaurant services; take-out restaurant services

Class 45

(2) awarding of licenses for franchising concepts; consultancy services relating to the legal aspects of franchising; granting of licences for franchise concepts; issuing licences for franchising concepts; legal advice relating to franchising; legal consultancy relating to franchising; licensing of franchising concepts; professional legal consultations relating to franchising; professional legal franchise consulting

Application Number 2,048,753
Language of Application English

Filing Date 2020-08-31

APPLICANT DETAILS

Applicant
Xiaolei Wang
48 Pike Road
Oakville
ONTARIO
L6H6C3

TRADEMARK DETAILS

Trademark Type
Design

Visual Representation



Disclaimer

The right to the exclusive use of the words CHICKEN AND BOMBER is disclaimed apart from the trademark.

Goods

Class 29

chicken; chicken breast fillets; chicken burger patties; chicken nuggets; chicken salad; chicken wings; cooked dish consisting primarily of stir-fried chicken and fermented hot pepper paste [dak-galbi]; fried chicken; fried meat; fried potatoes; prepared salads

Services

Class 35

(1) advice in the running of establishments as franchises; business management advisory services relating to franchising; developing promotional campaigns for business for others; developing promotional campaigns for others; development of marketing strategies and concepts for others; offering technical assistance in the establishment and operation of restaurant franchises; online

sales of food items; providing assistance in the field of business management within the framework of a franchise contract; purchasing agents; restaurant management for others; sales demonstrations of kitchen appliances

Class 43

(2) business catering services; fast food and non-stop restaurant services; fast-food restaurants; restaurant services; restaurant services featuring take-out services; restaurants; restaurants featuring home delivery; take-away fast food services; take-away restaurant services; take-out restaurant services

Class 45

(3) awarding of licenses for franchising concepts; consultancy services relating to the legal aspects of franchising; granting of licences for franchise concepts; issuing licences for franchising concepts; legal advice relating to franchising; legal consultancy relating to franchising; licensing of franchising concepts; professional legal consultations relating to franchising; professional legal franchise consulting

Application Number 2,048,873
Language of Application English

Filing Date 2020-09-01

APPLICANT DETAILS

Applicant

Lobster Made Easy Inc
249 Edgewater St
PO Box #4
Mahone Bay
NOVA SCOTIA
B0J2E0

TRADEMARK DETAILS

Lobster Made Easy

Trademark Type

Standard Characters

Disclaimer

The right to the exclusive use of the word Lobster is disclaimed apart from the trademark.

Goods

Class 29

lobster

Application Number 2,048,931
Language of Application English

Filing Date 2020-09-01

APPLICANT AND AGENT DETAILS

Applicant

Netflix Studios, LLC
5808 W. Sunset Blvd.
Los Angeles, CA 90028
UNITED STATES OF AMERICA

Agent

CLARK WILSON LLP
900 - 885 WEST GEORGIA STREET,
VANCOUVER, BRITISH COLUMBIA, V6C3H1

TRADEMARK DETAILS

DAD STOP EMBARRASSING ME

Trademark Type

Standard Characters

Services

Class 41

Entertainment services in the nature of a comedic drama television series; providing online non-downloadable video clips and multimedia entertainment recordings containing audio files, video files, artwork, and informational text from and related to a comedic drama television series

Claims

Priority Filing Date: March 11, 2020, Country or Office: JAMAICA, Application No: 080086 in association with the same kind of services

Application Number 2,049,010
Language of Application English

Filing Date 2020-09-01

APPLICANT DETAILS

Applicant

Nicholas Kryzanowski
123 Bellflower Rd
Winnipeg
MANITOBA
R3Y0J1

TRADEMARK DETAILS

Flaws & Sins Apparel

Trademark Type

Standard Characters

Goods

Class 25

A-shirts; adhesive bras; adhesive brassieres; adult pajamas; adult sweatpants; after-ski boots; albs; altar clothes; anglers' shoes; ankle boots; ankle socks; anklet socks; anoraks; anti-perspirant socks; anti-slip soles; aprons; aqua shoes; ascots; athletic apparel; athletic clothing; athletic footwear; athletic shoes; athletic shorts; athletic tights; athletic wear; babies' bibs of plastic; babies' underwear; baby booties; baby bottoms; baby clothes; baby clothing; baby doll pyjamas; baby layettes for clothing; baby pants; baby sandals; baeja [traditional Korean waistcoats for women]; bags specially adapted for ski boots; balaclavas; ball gowns; ballet flats; ballet shoes; ballet slippers; ballroom dancing shoes; bandanas; bandannas; barber smocks; baseball caps; baseball caps and hats; baseball cleats; baseball jerseys; baseball shirts; baseball shoes; baseball uniforms; basic upper garment of Korean traditional clothes [Jeogori]; basketball boots; basketball shoes; basketball sneakers; bath robes; bath sandals; bath slippers; bath wraps; bathing caps; bathing costumes; bathing costumes for women; bathing drawers; bathing suits; bathing suits for men; bathing trunks; bathrobes; beach clothes; beach coats; beach cover-ups; beach footwear; beach jackets; beach pyjamas; beach robes; beach shoes; beach wraps; beachwear; bed jackets; belts; belts made from imitation leather; belts made of leather; belts made out of cloth; belts of textile; berets; bermuda shorts; bib overalls; bib shorts; bicycle gloves; bike shoes; bikini bottoms; bikini tops; bikinis; blanket sleepers; blazers; blouses; blousons; blue jeans; boardshorts; body stockings; body suits; boleros; bolo ties; bomber jackets; bomber vests; bonnets; boot bags; boot cuffs; boot uppers; booties; boots; boots for motorcycling; boots for snowboarding; bow ties; bow-ties; bowling shoes; boxer briefs; boxer shorts; boxing shoes; boxing shorts; bras; brassières; breeches for wear; bridal footwear; bridal headpieces; bridal wear; bridesmaid dresses; briefs; business attire; business clothing; bustiers; bustle holder bands for obi [obiage]; bustles for obi-knots [obiage-shin]; button down shirts; caftans; camisoles; camouflage clothing for hunting; canvas shoes; cap peaks; cap visors; capelets; capes; capes for use in hair salons and barber shops; capri pants; caps; caps with visors; car coats; cardigans; cargo pants; cashmere jackets; cashmere sweaters; cassocks; casual clothing; casual clothing featuring pants, dresses and shorts; casual footwear; casual pants; casual shirts; casual shoes; casual wear; chaps; chasubles; chefs' hats; chemises undergarments; chemisettes; children's clothing; children's footwear;

children's shirts; Chinese gowns [Cheongsams]; christening gowns; climbing boots; climbing footwear; cloaks; clogs; cloth bibs; cloth hats; clothing belts; clothing cuffs; clothing for gymnastics; clothing for wear in judo practices; clothing for wear in wrestling games; clothing in particular pants; clothing in the nature of pants; clothing particularly pants; coats; coats for men; coats for men and women; coats for women; coats made of cotton; coats of denim; cocktail dresses; collar protectors; collared shirts; corduroy trousers; corselets; corset undergarment; corsets; cotton neckties; coveralls; cravates; cravats; crop tops; cuffs; culottes; cummerbunds; curling shoes; curling sliders; cycling gloves; cycling jackets; cycling shoes; cycling shorts; cyclists' clothing; datejime [tightening-up strings for kimonos]; datemaki [wrap belts for kimonos]; deck-shoes; denim coats; denim jackets; denim jeans; denim pants; denim shirts; detachable neckpieces for kimonos [haneri]; dickies; down jackets; dress clothing; dress pants; dress shields for clothing; dress shirts; dress shoes; dress skirts; dress suits; dresses; dresses made from skins; dressing gowns; dressing gowns and bath robes; driving gloves; duffel coats; duffle coats; dungarees; durumagi [Korean overcoats]; dust coats; duster coats; ear muffs; earmuffs; embossed soles and heels of rubber or of plastic materials; espadrilles; esparto shoes or sandals; evening coats; evening dresses; evening footwear; evening gowns; exercise footwear; exercise wear; fabric belts; fairy wings; fake fur jackets; fashion hats; fedoras; fencing vests; field hockey shoes; fingerless gloves; fishermen's jackets; fishing clothing; fishing hip waders; fishing tackle vests; fishing vests; fishing waders; fitted swimming costumes with bra cups; fittings of metal for footwear; fleece jackets; fleece pants; fleece pullovers; fleece shirts; fleece shorts; fleece tops; fleece vests; flight suits; flip-flops; folk costumes; football boots; football boots and studs therefor; football cleats; football shoes; football uniforms; footwear cushioning; footwear for track and field athletics; formal wear; foundation corsets; foundation girdles; frocks; full-length kimonos [nagagi]; full-length slippers; fur coats and jackets; fur hats; fur jackets; fur muffs; fur stoles; g-strings; gaiter straps; gaiters; galoshes; garter belts; garters; geta [Japanese style wooden clogs]; girdles; girdles for athletic use; gloves; gloves with conductive fingertips; gloves with conductive fingertips that may be worn while using hand-held electronic touch screen devices; gloves with conductive fingertips that may be worn while using handheld electronic touch screen devices; golf caps; golf cleats; golf footwear; golf hats; golf jackets; golf knickers; golf pants; golf shirts; golf shoes; golf shorts; golf skirts; golf trousers; golf wear; goloshes; gowns; greatcoats; grippers for curling shoes; gym boots; gym shorts; gym suits; gym wear; gymnastic shoes; hairdressing capes; hakama [pleated skirts for formal kimonos]; half slippers; half-boots; Halloween costumes; halter tops; handball shoes; hats; head bands; head scarves; head sweatbands; headbands; headbands against sweating; headscarfs; headscarves; heavy jackets; heel inserts; heel pieces for shoes; heel protectors for shoes; heelpieces for footwear; heelpieces for stockings; heels; high rain clogs (ashida); hiking boots; hiking shoes; hockey jerseys; hockey shoes; hockey sweaters; hockey uniforms; hooded jackets; hooded pullovers; hooded sweatshirts; hooded tops; horse-riding boots; hosiery; hot pants; housecoats; hunting boots; infant clothing; infant footwear; infants' boots; infants' shoes; infants' shoes and boots; infants' trousers; inner soles; insoles; insoles for footwear; insoles for shoes and boots; intimate apparel; jackets; jackets and socks; Japanese sleeping robes [nemaki]; Japanese style clogs and sandals; Japanese style sandals [zori]; Japanese style sandals of felt; Japanese style sandals of leather; Japanese style socks [tabi covers]; Japanese style socks [tabi]; Japanese style wooden clogs [geta]; Japanese toe-strap sandals [asaura-zori]; jean jackets; jeans; jeans coveralls; jerkins; jikatabi [Japanese split-toed work footwear]; jodhpurs; jogging pants; jogging shoes; jogging suits; judo suits; judo uniforms; jump suits; jumper dresses; jumpers; jumpsuits; karate suits; karate uniforms; kendo outfits; kerchiefs; kilts; kimonos; knee highs; knee-high stockings; knee-length stockings; knickers; knit hats; knit jackets; knit shirts; knit skirts; knit tops; knitted caps; knitted gloves; knitted hats; knitted shirts; knitted sweaters; knitted tops; knitted underwear; koma-geta [low wooden clogs]; korean outer jackets worn over basic garment

[magoja]; korean topcoats [durumagi]; korean traditional women's waistcoats [baeja]; koshimaki [undershirts for kimonos]; lab coats; lace boots; lace shawls; ladies' boots; ladies' suits; ladies' underwear; latex costumes; latex suits; layettes; leather belts; leather coats; leather gloves; leather jackets; leather pants; leather shoes; leather slippers; leather trousers; leg warmers; leg-warmers; legwarmers; leisure shoes; leisure suits; leotards; light-reflecting coats; light-reflecting jackets; lingerie; liveries; long jackets; long sleeve pullovers; long sleeve shirts; long sleeved vests; long underwear; long-sleeve blouses; long-sleeved t-shirts; loungewear; lounging pyjamas; low wooden clogs [hiyori-geta]; low wooden clogs [koma-geta]; maillots; maniples; mantillas; mantle cloaks; martial arts uniforms; masquerade costumes; maternity underwear; maternity wear; medical personnel footwear; men's sandals; men's shirts; men's socks; men's suits; men's underwear; metal fittings for Japanese style wooden clogs; metal fittings for Japanese-style wooden clogs; military clothing; military uniforms; mittens; moccasins; mock turtleneck shirts; moisture-wicking sports bras; moisture-wicking sports pants; money belts; monokinis; morning coats; motorcycle boots; motorcycle gloves; motorcycle jackets; motorcyclist boots; mountain bike shoes; mountaineering boots; mountaineering shoes; muffler scarves; mukluks; mules; muscle shirts; muu muu; muumuus; nagagi [full-length kimonos]; neck bands; neck ties; neck warmers; neckerchiefs; neckerchieves; neckties; negligees; nemaki [Japanese sleeping robes]; night dresses; night gowns; night shirts; nightcaps; nightdresses; nightgowns; nighties; nightshirts; nightwear; non-slip soles; novelty hats; nurse pants; nurses' uniforms; nylon stockings; obi [sash bands for kimonos]; obiage [bustle holder bands for obi]; obiage-shin [bustles for obi-knots]; one-piece bathing suits; open-necked shirts; outdoor winter clothing; outdoor winter footwear; outerwear jackets; over-trousers; overalls; overcoats; overshoes; pajama bottoms; pajamas; pant suits; panties; pants; panty girdles; pantyhose; paper hats for use as clothing items; pareos; pareus; parkas; party hats for use as clothing items; pea coats; pedicure slippers; peignoirs; perspiration absorbent underwear; perspiration absorbent underwear clothing; petticoats; pinafore dresses; pinafores; pique shirts; platform soles; pleated skirts for formal kimonos [hakama]; pocket kerchiefs; pocket squares; pockets for clothing; polo shirts; ponchos; pregnancy smocks; promotional caps; promotional t-shirts; protective metal members for shoes and boots; protective tips for footwear; pullovers; puttees; pyjamas; rain boots; rain coats; rain footwear; rain hats; rain jackets; rain pants; rain ponchos; rain suits; rain trousers; raincoats; rainproof jackets; rainwear; riding boots; riding gloves; riding jackets; riding shoes; rubber boots; rubber fishing boots; rubber shoes; rubber soles for jikatabi; rugby boots; rugby shirts; rugby shoes; rugby shorts; rugby tops; running shoes; running shorts; sabots; safari jackets; sandal-clogs; sandals; sandals and beach shoes; sarees; saris; sarongs; sash bands for kimono [obi]; sashes; sashes for wear; scarves; school uniforms; sedge hats (suge-gasa); serapes; shampoo capes; shawls; shawls and headscarves; shawls and stoles; sheepskin coats; sheepskin gloves; sheepskin jackets; shell jackets; shirt fronts; shirt yokes; shirt-jacs; shirts; shirts for suits; shoe soles; shoe soles for repair; shoe uppers; shoes; shoes soles for repair; short overcoat for kimono [haori]; short pants; short petticoats; short trousers; short-sleeve shirts; short-sleeved shirts; short-sleeved t-shirts; shortalls; shorts; shoulder scarves; shoulder wraps; shower caps; silk neckties; silk scarves; skateboarding gloves; ski and snowboard shoes and parts thereof; ski bibs; ski boot bags; ski boots; ski clothing; ski footwear; ski gloves; ski jackets; ski pants; ski slacks; ski suits; ski suits for competition; ski trousers; ski vests; ski wear; skiing shoes; skirt suits; skirts; skirts and dresses; skiwear; skorts; skull caps; slacks; sleep masks; sleeping garments; sleepwear; sleeved jackets; sleeveless jackets; sleeveless jerseys; slipovers; slipper socks; slipper soles; slippers; slips; small hats; smocks; smoking jackets; snap crotch shirts for infants and toddlers; sneakers; snow boarding suits; snow boots; snow pants; snow suits; snow trousers; snowboard boots; snowboard jackets; snowboard pants; snowboard shoes; snowboard trousers; snowmobile suits; soccer boots; soccer shoes; soccer uniforms; sock garters; sock suspenders; socks; socks and stockings; softball caps; softball cleats;

soles for footwear; soles for Japanese style sandals; spats; sport bibs; sport coats; sport jackets; sport shirts; sport stockings; sports bras; sports caps and hats; sports clothing; sports coats; sports footwear; sports jackets; sports jerseys; sports jerseys and breeches for sports; sports overuniforms; sports shirts with short sleeves; sports shoes; sports singlets; sports uniforms; sports vests; sportswear; stocking suspenders; stoles; strapless bras; strapless brassieres; straw hats; string fasteners for haori [haori-himo]; studs for football boots; suede jackets; suit vests; suits; suits of leather; sun hats; sun protective clothing; sun suits; sun visors; suspender belts; suspender belts for men; suspender belts for women; suspender braces; suspenders; sweat bands; sweat jackets; sweat pants; sweat shirts; sweat socks; sweat suits; sweat tops; sweat-absorbent socks; sweat-absorbent stockings; sweat-absorbent underclothing; sweat-absorbent underwear; sweatbands; sweaters; sweatshirts; swim caps; swim suits; swim wear for gentlemen and ladies; swimming caps; swimming costumes; swimming suit bottoms; swimming trunks; swimsuits; swimwear; t-shirts; tabi [Japanese-style socks]; Taekwondo suits; tams; tank tops; tankinis; tap pants; team jerseys; team shirts; tee-shirts; tennis shirts; tennis shoes; tennis shorts; tennis wear; theatrical costumes; thermal socks; thermal underwear; thong sandals; thong underwear; three-piece suits; ties; tightening-up strings for kimonos (datejime); tights; tips for footwear; toe straps for Japanese style sandalszori; toe straps for Japanese style wooden clogs; togas; tongue for shoes and boots; top hats; toques; track and field shoes; track jackets; track pants; track shoes; track suits; training shoes; training suits; trench coats; trouser braces; trouser socks; trouser straps; trousers; trousers for sweating; trousers of leather; tube tops; tunics; turbans; turtleneck sweaters; tutus; tuxedo belts; tuxedos; underclothing; undergarments; underpants; undershirts; undershirts for kimonos [juban]; undershirts for kimonos [koshimaki]; underskirts; underwear; uniforms for medical personnel; uppers for Japanese style sandals; uppers of woven rattan for Japanese style sandals; ushankas [fur hats]; valenki [felted boots]; veils; vests; visor caps; visors for athletic use; volleyball jerseys; volleyball shoes; waist belts; waist strings for kimonos [koshihimo]; waistbands; waistcoats; walking shoes; walking shorts; waraji [Japanese footwear made of rice straw]; warm-up pants; warm-up suits; warm-up tops; waterproof jackets; waterproof jackets and pants; waterproof pants; waterskiing suits; wedding dresses; wedding gowns; wellies; wellington boots; welts for footwear; welts for shoes; wet suits; wet suits for surfing; wet suits for water-skiing; wet suits for water-skiing and sub-aqua; wetsuits for water-skiing; wetsuits for windsurfing; wimples; wind coats; wind resistant jackets; wind vests; wind-jackets; wind-resistant jackets; wind-resistant vests; windcheaters; windjammers for motorcycles; winter boots; winter coats; winter gloves; winter jackets; women's blouses; women's ceremonial dresses; women's foldable slippers; women's lingerie; women's shirts; women's shoes; women's socks; women's sportswear; women's suits; women's underwear; wooden main bodies of Japanese style wooden clogs; wooden shoes; wooden supports of Japanese style wooden clogs; woolen tights; woollen socks; woolly hats; work boots; work shoes; work shoes and boots; working overalls; woven rattan uppers for Japanese-style sandals; woven shirts; woven tops; woven underwear; wrap belts for kimonos [datemaki]; wrist bands; wristbands; yoga pants; yoga shoes; zoot suits; zori [Japanese-style sandals]

Services

Class 35

account auditing; accountancy; accountancy advice relating to tax preparation; accountancy advice relating to taxation; accountancy advice relating to the preparation of tax returns; accountancy services; accountancy services relating to accounts receivable; accounting; accounting advisory services; accounting consultation; accounting for third parties; accounting services; accounting services for mergers and acquisitions; accounting services relating to tax planning; acquisition and merger consultation; addressing of envelopes; administration of a

discount program for enabling participants to obtain discounts on goods and services through use of a discount membership card; administration of business payroll for others; administration of consumer loyalty programs; administration of cultural and educational exchange programs; administration of customer loyalty programs; administration of employee benefit plans concerning fitness club memberships; administration of employee pension plans; administration of frequent flyer programs; administration of frequent flyer programs that allow members to redeem miles for points or awards offered by other loyalty programs; administration of incentive award programmes to promote the sale of the goods and services of others; administration of loyalty rewards programmes featuring trading stamps; administration of pre-paid health care plans; administration of prepaid health care plans; administration of savings accounts; administrative accounting; administrative assistance in responding to calls for tenders; administrative assistance in responding to requests for proposals [RFPs]; administrative hotel management; administrative management of health care clinics; administrative management of hospitals; administrative processing of insurance claims; administrative processing of purchase orders; administrative processing of purchase orders within the framework of services provided by mail-order companies; administrative services in the field of employee stock plans; advertising agencies; advertising agency services; advertising and business management consultancy; advertising by transmission of on-line publicity for third parties through electronic communications networks; advertising copywriting; advertising flyer distribution; advertising flyer distribution for others; advertising of commercial real estate for others; advertising of residential real estate for others; advertising on the Internet for others; advertising relating to pharmaceutical products and in-vivo imaging products of others; advertising services for promoting a series of films for others; advertising services for promoting public awareness of environmental issues and initiatives; advertising services for promoting public awareness of the benefits of physical activity; advertising services for promoting public awareness of the need for organ and tissue donation; advertising services for promoting the brokerage of stocks and other securities for others; advertising services of a radio and television advertising agency; advertising text publication services for others; advertising the goods and services of others; advertising the goods and services of others in periodicals, brochures and newspapers; advertising the goods and services of others in the popular and professional press; advertising the goods and services of others through all public communication means; advertising the goods and services of others via electronic media and specifically the internet; advice and information about customer services and product management and prices on Internet sites in connection with purchases made over the Internet; advice and information concerning commercial business management; advice concerning chemical product marketing; advice in the field of business management and marketing; advice in the running of establishments as franchises; advice relating to the organisation and management of business; advisory and consultancy services in the field of export, export services, export promotion information and services; advisory services for business management; advisory services relating to business management; advisory services relating to business management and business operations; airport management; alcoholic beverage procurement services for others; analysis of market research data and statistics; arranging and conducting automobile trade show exhibitions; arranging and conducting book trade fairs; arranging and conducting craft trade show exhibitions; arranging and conducting fitness equipment trade show exhibitions; arranging and conducting of auction sales; arranging and conducting of real estate auctions; arranging and conducting toy trade show exhibitions; arranging newspaper subscriptions for others; arranging of subscriptions for the publications of others; arranging subscriptions of the online publications of others; arranging subscriptions to newspapers for others; arranging subscriptions to online publications for others; assessment and evaluation of taxes; Assistance, advisory services and consultancy with regard to business organization; association services for promoting the interests of nurses; association

services for promoting the interests of teachers; association services for promoting the interests of truckers; attorney referrals; auction services; auctioneering; auctioneering of property; auctioneering provided on the internet; auctioning of vehicles; auctioning via telecommunication networks; audience rating determination for radio and television broadcasts; auditing of financial statements; auditing utility rates for others; automobile dealerships; bakery shops; bartering of goods for others; beverage concession stands; billing services; boat dealerships; book-keeping; bookkeeping services; business acquisition and merger consultation; business acquisitions consultation; business acquisitions consulting; business administration and management; business administration assistance; business administration consultancy; business administration consulting services; business administration in the field of transport and delivery; business administration services; business appraisals; business appraisals and evaluations in business matters; business auditing; business consulting in the field of business acquisitions and mergers; business consulting in the field of business networking; business consulting in the field of business relocation; business efficiency expert services; business efficiency services; business feasibility studies; business information services in the field of incorporation and trademarks; business information services in the field of stock prices; business information services in the field of taxes; business intelligence reporting; business intermediary services relating to the matching of potential private investors with entrepreneurs needing funding; business invoicing services; business management; business management advice; business management advisory services relating to franchising; business management analysis; business management and advice; business management and enterprise organization consultancy; business management and organization consultancy; business management assistance; business management assistance and particularly carrying out tasks necessary for the smooth conduct of sales by auction; business management assistance for industrial and commercial companies; business management assistance for industrial or commercial companies; business management consultancy; business management consultancy and advisory services; business management consultancy as well as development of processes for the analysis and the implementation of strategy plans and management projects; business management consultancy in the field of transport and delivery; business management consultancy services; business management consultancy via the Internet; business management consultation; business management consulting; business management consulting with relation to strategy, marketing, production, personnel and retail sale matters; business management for a trade company and for a service company; business management for freelance service providers; business management for shops; business management in the field of transport and delivery; business management of hotels; business management of hotels for others; business management of performing artists; business management of reimbursement programmes for others; business management of reimbursement programs for others; business management of sports people; business management planning; business management services; business management services relating to information and data compiling and analyzing; business management supervision; business marketing consulting services; business merchandising display services; business merger consultation; business organisation and management consulting services; business organisation consulting; business organization advice for others; business organization and management consultancy including personnel management; business organization and management consulting; business organization and operation consultancy; business organization consultancy services; business planning; business process re-engineering; business process reengineering services; business project management services for construction projects; business relocation services; business risk assessment services; business risk management services; business services, namely developing fundraising campaigns for others; business strategic planning; business strategic planning services; business strategy development services; business succession planning; butcher shops; buying club services; career placement;

career placement consulting services; career planning; carrying out auction sales; catalogue shopping services in the field of automobile parts; catalogue shopping services in the field of clothing; catalogue shopping services in the field of cosmetics; catalogue shopping services in the field of home entertainment electronics; catalogue shopping services in the field of photographic equipment; catalogue shopping services in the field of sporting goods; chamber of commerce services promoting business and tourism in the City of Ottawa; chamber of commerce services promoting business and tourism in the Niagara region; chamber of commerce services promoting business and tourism in the Okanagan Valley; clearinghouse services for radio and television; clerical services; clothing concession stands; collection of market research information; commercial assistance in business management; commercial business management; commercial business management services; commercial information agencies providing tax information; commercial lobbying services; compilation of advertisements for use as web pages on the internet; compilation of business directories; compilation of statistics; compilation, production and dissemination of advertising matter for others; computer database management services; computer file management; computerised database management; computerised file management; computerised market research services; computerized accounting services; computerized business file management; computerized central file management; computerized database management; computerized file management; computerized market research services; computerized on-line gift ordering service which matches the gift giver's requirements with the gift recipient's wants and needs; computerized on-line ordering services in the field of cosmetics; computerized online ordering featuring clothing; computerized word processing; conducting an on-line tradeshow exhibition in the field of jewellery; conducting business and market research surveys for others; conducting employee incentive award programs to promote on the job safety; conducting employee incentive award programs to promote productivity and quality; conducting market surveys for others; conducting marketing studies; conducting of auction sales; conducting of business feasibility studies; conducting public opinion polls; conducting public opinion surveys; conference call transcription services; consignment sale of art; consignment sale of clothing; consignment sale of jewellery; consignment sale of sporting goods; construction cost management; consultancy and advisory services in the field of business strategy; consultancy of personnel recruitment; consultancy relating to personnel management; consultation in the field of business acquisitions; consulting and information concerning accounting; consulting in the fields of business organization and management; consulting services in business organization and management; consumer research; consumer research services; copying of documents; copying of documents for others; corporate identity services; corporate image development consultation; cost accounting; cost analyses; cost analysis; cost assessment services; cost management in the field of health care; cost price analysis; cost-price analysis; cost/price analysis; coupon procurement services for others; creating and updating advertising material for others; creation of trademarks for others; credit card registration services; credit card reward program services; customer service in the field of airline reservations; customer service in the field of automobile repair; customer service in the field of computer servicing; database management; database marketing services in the form of compiling customer specific databases; delicatessens; design of marketing surveys; design of public opinion surveys; developing and coordinating volunteer projects for charitable organisations; developing and coordinating volunteer projects for charitable organizations; developing marketing strategies and marketing concepts for others; developing promotional campaigns for business for others; developing promotional campaigns for others; development of hospital management systems; development of marketing strategies and concepts for others; direct mail advertising of the goods and services of others; direct marketing of the goods and services of others; discount clothing stores; discount cosmetics stores; discount photographic equipment stores; discount sporting goods stores; dissemination of advertising for others via an on-

line communications network on the internet; dissemination of advertising for others via the Internet; dissemination of advertising matter for others; distribution of advertisements and commercial announcements for others; distribution of advertising mail and of advertising supplements attached to regular editions for others; distribution of advertising materials for others; distribution of handbills; distribution of products for others for advertising purposes; distribution of samples for publicity purposes; distributorships in the field of automotive parts; distributorships in the field of clothing; distributorships in the field of cosmetics; document copying services; document reproduction; door to door selling of books; door to door selling of cookies; door to door selling of cosmetics; door to door selling of magazines; door to door selling of meat; drawing up of statements of accounts; duplication of library material; economic analysis; economic forecasting; economic forecasting and analysis; electronic billboard advertising of the goods and services of others; employee relocation; employee relocation services; employment agencies; employment agency services; employment agency services relating to au pairs; employment counselling and recruiting; employment management agencies; employment outplacement services; employment recruiting services; employment skills testing; evaluation of employee performances; executive recruiting services; executive search and placement services; export and import agencies; fashion show exhibitions for commercial purposes; financial statement preparation and analysis for businesses; flea markets; florist shop services; food concession stands; foreign trade information and consultation; foreign trade information and consultation services; forestry management; forestry management consulting services; fruit stands; general information clearing house services; gift registry services; goods import-export agencies; handbill distribution; health care cost containment services; home demonstrations selling jewellery; home demonstrations selling lingerie; home demonstrations selling toys; home jewellery parties; home lingerie parties; hospital administration; hospital management; hotel management; hotel management for others; human resources consultancy; human resources consultation; human resources consulting services; human resources management; human resources outsourcing services; import and export agencies; import-export agencies; import-export agencies in the field of energy; import-export agency services; income tax consulting services; indexing of documents for others; interim business management; inventory control; inventory control services; inventory management in the field of auto parts; inventorying merchandise; invoicing; invoicing services; issuing and updating of advertising texts for others; jewellery concession stands; job and personnel placement; job placement; job placement services; key return registration services; keypunching; labour exchanges; labour unions; layout services for advertising purposes; leasing of advertising space on the Internet for employment advertising; leasing of office equipment; literary agencies; magazine advertising for others; magazine mail order services; mail order book clubs; mail order services in the field of books; mail order services in the field of clothing; mail order services in the field of cosmetics; mail order services in the field of furniture; mail order services in the field of jewellery; mail order services in the field of shoes; mail order services in the field of toys; mail sorting, handling and receiving; mailing list preparation; management and compilation of computerised databases; management and compilation of computerized databases; management and operation assistance to commercial businesses; management of an airline company; management of computerized databases; management of health care clinics for others; management of performing artists; management of professional athletes; market analysis; market analysis and research; market analysis and research services; market analysis and studies; market assessment services; market opinion polling studies; market reports and studies; market research by means of a computer database; market research services; market research studies; market segmentation consultation; market studies; market study and analysis of market studies; marketing analysis services; marketing research; marketing research in the fields of cosmetics, perfumery and beauty products; marketing services in the field of arranging for the distribution of

the products of others; marketing services in the field of evaluating markets for existing goods and services of others; media relations services; mediation and conclusion of commercial transactions for others; mediation of advertising for others; mediation of agreements for others for the sale and purchase of goods; mediation of contracts for purchase and sale of products; mediation of trade business for third parties; medical billing; medical cost management; medical transcription services; modeling agencies; modeling services for advertising or sales promotion; modelling agency services; modelling for advertising or sales promotion; negotiation and conclusion of commercial transactions for third parties; negotiation of business contracts for others; news clipping services; newspaper advertising for others; newspaper subscriptions; offering technical assistance in the establishment and operation of bakery shop franchises; offering technical assistance in the establishment and operation of car wash franchises; offering technical assistance in the establishment and operation of clothing store franchises; offering technical assistance in the establishment and operation of restaurant franchises; office machines and equipment rental; office support staff recruitment services; on-line advertising for others on computer networks; on-line advertising the goods and services of others on computer communications networks; on-line auction bidding for others; on-line auctioneering; on-line trading services in which seller posts products to be auctioned and bidding is done via the Internet; on-line wholesale store services featuring agricultural equipment; on-line wholesale store services featuring animal grooming preparations; on-line wholesale store services featuring audiovisual equipment; on-line wholesale store services featuring stationery supplies; on-line wholesale store services featuring vehicles; online advertising for others via a computer communications network; online auction services; online department store services; online retail services for downloadable and pre-recorded music and movies; online retail services for downloadable digital music; online retail services for downloadable ring tones; online sales of arts and crafts; online sales of automobile parts; online sales of body care products; online sales of car audio electronics; online sales of clothing; online sales of cosmetics; online sales of downloadable pre-recorded music; online sales of downloadable ring tones; online sales of food items; online sales of footwear; online sales of headwear; online sales of home entertainment electronics; online sales of housewares; online sales of lingerie; online sales of photographic equipment; online sales of sporting goods; online sales of toys; online wholesale store services featuring baked goods; online wholesale store services featuring beer; online wholesale store services featuring cocoa; online wholesale store services featuring weapons; operating marketplaces; operation of a book store; operation of a clothing store; operation of a computer database containing job postings; operation of a department store; operation of a furniture store; operation of a telephone switchboard for others; operation of computer equipment store; operation of grocery store; opinion polling; organisation and management of customer loyalty programs; organisation for a third party of telephone welcoming services and of telephone receptionist services; organisation of fashion shows for commercial purposes; organisation of Internet auctions; organization of exhibitions of flowers and plants for commercial or advertising purposes; organization of fashion shows for promotional purposes; organizing and conducting job fairs; outsourcing of insurance services; outsourcing of legal services; outsourcing of payroll services; outsourcing of translation services; outsourcing of web development services; payroll preparation; payroll preparation services; personality testing for business purposes; personality testing for recruitment purposes; personality testing for the selection of personnel; personnel consultancy; personnel management; personnel management and employment consultancy; personnel management assistance services; personnel management consultancy; personnel management consultation; personnel management consulting; personnel placement; personnel placement and recruitment; personnel placement consultancy; personnel recruitment; personnel recruitment and placement; personnel recruitment services and employment agencies; personnel relocation; personnel relocation services; personnel

selection using psychological testing; phonetic transcription; photocopying; photocopying services; placement of staff; placing advertisements for others; planning concerning business management, namely, searching for partners for amalgamations and business take-overs as well as for business establishments; political action committee services in the form of promoting the interests of auto workers; political action committee services in the form of promoting the interests of farmers; preparation of business reports; preparation of custom advertisements for others; preparation of financial statements; preparation of wage slips; preparing advertisements for others; preparing and placing advertisements for others; preparing and placing of advertisements for others; preparing and placing outdoor advertisements for others; preparing business reports; preparing income tax reports; preparing mailing lists; press advertising consultancy; press clipping services; price comparison rating of accommodations; price comparison services; processing warranty registration documents for others; procurement of contracts for the purchase and sale of goods; procurement of contracts for the purchase and sale of goods and services; procurement services in the form of purchasing computer hardware; procurement services in the form of purchasing heavy equipment; procurement services in the form of purchasing vehicles; procurement services in the form of purchasing weapons; procuring of contracts for the purchase and sale of goods of others; producing promotional videotapes, video discs, and audio visual recordings for others; product demonstration services in shop windows by live models; product demonstrations of kitchen appliances; production of advertising films for others; production of advertising materials for others; production of advertising matter and commercials for others; production of infomercials; production of teleshopping programmes; production of television commercials; professional consultancy relating to personnel management; profit survey and analysis services; promoting goods and services through the distribution of discount cards; promoting the artwork of others by means of providing online portfolios via a website; promoting the goods and services of others by arranging for sponsors to affiliate their goods and services with soccer competitions; promoting the goods and services of others by preparing and placing advertisements in electronic magazines; promoting the goods and services of others through advertisements on Internet websites; promoting the goods and services of others through infomercials; promoting the goods and services of others through the administration of sales and promotional incentive schemes involving trading stamps; promoting the goods and services of others through the distribution of discount cards; promoting the music of others by means of providing online portfolios via a website; promoting the sale of credit card accounts through the administration of incentive award programs; promoting the sale of goods and services by awarding purchase points for credit card use; promoting the sale of goods and services of others by awarding purchase points for credit card use; promoting the sale of goods and services through a consumer loyalty program; promoting the sale of goods and services through promotional contests and the distribution of related printed material; promotional management for sports personalities; providing a searchable online advertising guide featuring the goods and services of other on-line vendors on the internet; providing administrative assistance to pharmacies for managing drug inventories; providing advertising space in a periodical; providing advertising space in periodicals, newspapers and magazines; providing advice and information relating to commercial business management; providing advice in the field of business efficiency; providing advice in the field of business management and marketing; providing advice relating to the analysis of consumer buying habits; providing an on-line commercial information directory on the internet; providing an online commercial information directory on the Internet; providing and rental of advertising space on the internet; providing and rental of exhibition stands and booths; providing assistance in the field of business management within the framework of a franchise contract; providing business information in the field of social media; providing business management start-up support for other businesses; providing business marketing information for others; providing consumer product information in the

field of office computer equipment via a website; providing electronic verification of online orders of digital content; providing employment counseling services; providing focus group services; providing home shopping services of car audio electronics via the Internet; providing home shopping services of cosmetics by means of television; providing home shopping services of fitness equipment via the Internet; providing home shopping services of home entertainment electronics by means of television; providing home shopping services of jewellery by telephone; providing home shopping services of sporting goods via the Internet; providing hotel rate comparison information; providing human resources management and recruitment services for others; providing information in the area of global sustainable business solutions; providing information in the field of time management; providing information relating to employee relocation services; providing market intelligence services; providing marketing consultancy in the field of social media; providing marketing consulting in the field of social media; providing marketing strategies for others; providing on-line auction services; providing online auction services; providing online commercial directory information services; providing operational business assistance to enterprises; providing promotional coupon programs pertaining to a line of food products; providing quality management systems auditing; providing tax information via an interactive website; provision of information relating to market studies; provision of market research information; provision of marketing reports; provision of space on websites for advertising goods and services; psychological testing for the selection of personnel; psychometric testing for the selection of personnel; public opinion polling; public opinion surveys; public policy research services; public relations; public relations consultancy; public relations services; public utilities cost management; publication of publicity texts; publicity agencies; publicity agency services; publicity agents; publicity bureau services; purchasing agents; rating of accommodations services; real estate advertising services for others; real estate marketing analysis services; real estate sales management services; recruitment of flight personnel, technical ground staff and non-technical ground staff; recruitment of high-level management personnel; relocation services for business; relocation services for businesses; rental of advertising space; rental of advertising space on web sites; rental of office equipment in co-working facilities; rental of office machinery and equipment; rental of photocopiers; rental of photocopying machines; rental of sales stands; rental of typewriters and copying machines; rental of vending machines; renting of advertising spaces; restaurant management for others; resumé preparation services; retail book store services; retail clothing store services; retail computer equipment store services; retail convenience store services; retail department store services; retail furniture store services; retail grocery store services; retail sale of audio equipment; retail sale of automobile parts; retail sale of clothing; retail sale of computer software; retail sale of cosmetics; retail sale of food; retail sale of jewellery; retail sale of lingerie; retail sale of photographic equipment; retail sale of sporting goods; retail sale of toys; retail services for alcoholic beverages; retail services for chemicals for use in agriculture; retail services for computer hardware; retail services for computer software; retail services for jewellery; retail services for navigation devices; retail services for pharmaceutical, veterinary and sanitary preparations and medical supplies; retail services for works of art provided by art galleries; retail services in relation to litter for animals; retail services in relation to non-alcoholic drinks; retail services in relation to works of art; retail services provided by bakery shops; retail services provided by butcher shops; retail services provided by candy stores; retail services provided by clothing boutiques; retail services provided by consignment stores; retail services provided by convenience stores; retail services provided by hypermarkets; retail services provided by lawn, garden and nursery stores; retail services provided by music and record stores; retail services provided by music stores; retail services provided by record stores; retail services provided by television stores; retail services provided by tobacco shops; retail services relating to automobile parts; retail services relating to candy; retail services relating to delicatessen products; retail

services relating to fake furs; retail services relating to ice cream; retail shop window display arrangement services; retail store reward programs; retail store services featuring clothing; résumé preparation services; sale of cars; sale of clothing; sale of computer software; sale of customized gift baskets; sale of flowers; sale of motor vehicles; sales demonstration for others; sales demonstrations of computer hardware; sales demonstrations of kitchen appliances; sales demonstrations of surgical instruments; sales promotion for others by means of privileged user cards; sales promotion for others provided through the distribution and the administration of privileged user cards; sales promotion for others through trading stamp schemes; sales volume tracking for others; sales volume tracking services; sample distribution; scrap dealerships; scriptwriting for advertising purposes; search engine optimisation; search engine optimization; secretarial and clerical services; secretarial services; selling domain names; services for provision of foreign trade information; services to determine the audience affected by advertisements; serving as a human resources department for others; shop at home parties selling jewellery; shop at home parties selling lingerie; shop at home parties selling toys; shop window display arrangement services; shop window dressing; shopping centre administration services; shorthand; shorthand secretarial services; shorthand services; shorthand typing; shorthand typing services; social media strategy consulting; sports recruiting services for high school athletes; staff placement services; statistical analysis and reporting services for business purposes; statistical evaluation of data from market studies; statistical evaluation of market research data; statistical evaluations of marketing data; stenographic transcription; stenographic transcription services; stenography; stenography services; strategic business analysis; strategic business planning; street vending of flowers; street vending of food; subscription to a television channel; subscriptions to books; subscriptions to comic books; subscriptions to electronic journals; subscriptions to newspapers; subscriptions to reviews; supermarkets; supply chain management services; talent agencies; talent agency services in the nature of business management of performing artists; talent management agencies; tax advisory services; tax and taxation planning, advice, information and consultancy services; tax auditing; tax auditing services; tax declaration procedure services; tax filing services; tax preparation; tax preparation services; telemarketing services; telephone and television auctions; telephone answering for unavailable subscribers; telephone answering service; telephone answering services; telephone directory assistance services; telephone order-taking services for others; telephone voice message transcription services; television advertising for others; temporary employment agencies; temporary employment agency services; temporary personnel services; testing to determine employment skills; testing to determine professional competency; theatrical agencies; tracking and monitoring energy consumption for others for account auditing purposes; tracking and monitoring fluctuation in gasoline prices for others for account auditing purposes; travel management; travel reward programs; typing; typing services; updating and maintenance of data in computer databases; utility meter reading for billing purposes; vehicle registration and title transfer; vending machine services; voter registration; wage payroll preparation; web indexing for commercial or advertising purposes; web site optimization services; web site traffic optimisation; web site traffic optimization; wholesale sales of auto parts; wholesale sales of clothing; wholesale sales of cosmetics; wholesale sales of home entertainment electronics; wholesale sales of sporting goods; wholesale services for pharmaceutical, veterinary and sanitary preparations and medical supplies; wholesale store services featuring audiovisual equipment; wholesale store services featuring baked goods; wholesale store services featuring beer; wholesale store services featuring chocolate; wholesale store services featuring clothing; wholesale store services featuring cookware; wholesale store services featuring cutlery; wholesale store services featuring desserts; wholesale store services featuring diving equipment; wholesale store services featuring ice cream; wholesale store services featuring saddlery; wholesale store services featuring smartphones; wholesale store services featuring smartwatches; wholesale store

services featuring sorbets; wholesale store services featuring teas; wholesale store services featuring toys; window display arrangement services; window display services; window dressing services for advertising purposes; word processing; word processing and typing services; work analysis to determine worker skill sets and other worker requirements; writing of curriculum vitae for others; writing of publicity texts for others; writing of résumés for others

Application Number 2,049,033
Language of Application English

Filing Date 2020-09-02

APPLICANT DETAILS

Applicant

Chuanhuicheng International Trade
(Shenzhen) Co., LTD
712, Bldg. C, Zhantao Technology Bldg
Minzhi Street, Longhua District
Shenzhen, Guangdong,
CHINA

TRADEMARK DETAILS

Hezbjiti

Trademark Type

Standard Characters

Goods

Class 11

book lights; carbon for arc lamps; chandeliers; electric lights for christmas trees; fairy lights for festive decoration; floor lamps; fluorescent lamp tubes; lampshades; lanterns; led landscape lights; led light bulbs; led luminaires; lighting fixtures; lights for wall mounting; overhead lamps; portable paper lanterns [chochin]; reading lights; safety lamps for underground use; solar powered lamps; string lights for festive decoration

Application Number 2,049,034
Language of Application English

Filing Date 2020-09-02

APPLICANT DETAILS

Applicant

Shenzhen Aopixi Electronic Commerce Co.,
Ltd.
26-G, Block A, Guanghao International Center
Intersection of Meilong Road and Zhongmei
Road
Daling Community, Minzhi St., Longhua Dist.
Shenzhen ,Guangdong,
CHINA

TRADEMARK DETAILS

Heceltt

Trademark Type

Standard Characters

Goods

Class 11

book lights; carbon for arc lamps; chandeliers; electric lights for christmas trees; fairy lights for festive decoration; floor lamps; fluorescent lamp tubes; lampshades; lanterns; led landscape lights; led light bulbs; led luminaires; lighting fixtures; lights for wall mounting; overhead lamps; portable paper lanterns [chochin]; reading lights; safety lamps for underground use; solar powered lamps; string lights for festive decoration

Application Number 2,049,221
Language of Application English

Filing Date 2020-09-02

APPLICANT AND AGENT DETAILS

Applicant

MAG CANADA BEVERAGE LTD.
Unit 100 - 565 Great Northern Way
Vancouver
BRITISH COLUMBIA
V5T0H8

Agent

GOWLING WLG (CANADA) LLP
550 BARRARD STREET, SUITE 2300,
VANCOUVER, BRITISH COLUMBIA, V6C2B5

TRADEMARK DETAILS

LEMON LIFE

Trademark Type

Standard Characters

Goods

Class 32

(1) Ale; beer; beer-based cocktails; flavoured beers; lager; porter; stout.

Class 33

(2) Alcoholic cocktails; alcoholic cocktails in the form of chilled gelatins; alcoholic coolers; alcoholic fruit drinks; alcoholic lemonade; alcoholic malt-based coolers; alcoholic punches; alcoholic seltzer; hard seltzer; vodka cocktails; vodka seltzer.

Application Number 2,049,227
Language of Application English

Filing Date 2020-09-02

APPLICANT DETAILS

Applicant

Lunax Natural Inc.
2401-89 Dunfield Ave
Toronto
ONTARIO
M4S0A4

TRADEMARK DETAILS

SANOLOGY

Trademark Type

Standard Characters

Goods

Class 03

3-in-1 hair shampoos; after sun creams; after sun moisturisers; after-shave moisturizing creams; after-sun creams; after-sun creams for cosmetic use; after-sun gels; after-sun gels for cosmetic purposes; after-sun lotions; after-sun lotions for cosmetic purposes; after-sun milks; after-sun milks for cosmetic purposes; after-sun moisturizers; age retardant gels; age retardant gels for cosmetic purposes; age retardant lotions for cosmetic purposes; age spot reducing creams; age spot reducing creams for cosmetic purposes; all purpose cleaning preparations; all purpose scouring liquids; all purpose scouring powders; all-purpose cleaning preparations; anti-ageing moisturizers; anti-ageing skincare preparations; anti-aging cream; anti-aging creams; anti-aging creams for cosmetic purposes; anti-aging creams for cosmetic use; anti-aging moisturizers; anti-aging skin care preparations; anti-aging skincare preparations; anti-freckle creams; anti-freckle creams for cosmetic purposes; anti-wrinkle creams; anti-wrinkle creams for cosmetic purposes; anti-wrinkle creams for cosmetic use; baby lotion; beauty lotions; beauty masks; beauty serums; body and beauty care cosmetics; body care soap; body cleansers; body creams; body creams for cosmetic purposes; body creams for cosmetic use; body emulsions for cosmetic purposes; body lotions for cosmetic purposes; body mask creams; body mask creams for cosmetic purposes; body mask lotions; body mask lotions for cosmetic purposes; body mask powders; body mask powders for cosmetic purposes; body masks; body mist; body moisturizers; body moisturizing milk; body oils; body shampoo; cleansing milk for skin care; cosmetic body creams; cosmetic body scrubs; cosmetic cleansing creams; cosmetic creams; cosmetic creams and gels for the face, hands and body; cosmetic creams and lotions; cosmetic creams and lotions for face and body care; cosmetic creams for firming skin around eyes; cosmetic creams for skin care; cosmetic creams, milks, lotions, gels and powders for the face, hands and body; cosmetic face powders; cosmetic facial lotions; cosmetic facial masks; cosmetic facial moisturizers; cosmetic hair care preparations; cosmetic hair dressing preparations; cosmetic hair lotions; cosmetic hair regrowth inhibiting preparations; cosmetic hand creams; cosmetic oils for the skin; cosmetic skin care lotions; cosmetic skin care preparations; cosmetic skin lotions; cosmetic sun-protecting preparations; cosmetics for personal use; cosmetics for use on the skin; creams for the hair; day cream; essential oils for cosmetic purposes; ethereal oils for the manufacture of perfumes; eye

compresses for cosmetic purposes; eye contour creams; eye cream; eye creams for cosmetic purposes; eye gels; eye gels for cosmetic purposes; eye lotions; eye make-up removers; face and body beauty creams; face and body creams; face and body creams for cosmetic purposes; face and body lotions; face and body milk for cosmetic purposes; face cream; face creams for cosmetic use; facial lotion; facial lotions; facial make-up; facial masks; facial moisturizers; facial oils; facial powder; facial scrubs; facial toners; facial washes; hair balms; hair care creams; hair care creams for cosmetic purposes; hair care lotions; hair care lotions for cosmetic purposes; hair masks; hair moisturizers; hair oils; hand cleansers; hand cream; hand creams; hand creams for cosmetic purposes; hand lotions; hand lotions for cosmetic purposes; hand scrubs; hemp oil for cosmetic purposes; hemp seed oil for cosmetic purposes; make-up removing gels; make-up removing milks; makeup; makeup remover; moisturising skin lotions; moisturizing creams; moisturizing milk; natural perfumery; non-medicated preparations for the care of hair; non-medicated preparations for the care of skin; non-medicated skin creams; oils for cosmetic purposes; self-tanning creams; self-tanning lotions; shampoos and conditioners; skin abrasives; skin care cosmetics; skin care creams; skin care lotions; skin care preparations; skin cleansers; skin cleansing creams; skin cleansing foams; skin cleansing lotions; skin conditioners; skin conditioning creams for cosmetic purposes; skin creams; skin creams for cosmetic purposes; skin lighteners; skin lightening creams; skin lotions; skin moisturisers; skin moisturizer masks; skin moisturizers; skin moisturizing cream; skin moisturizing gel; skin toners; skin whitening creams; solid hair conditioner; solid hair conditioner bars; solid shampoo; sun creams; sun creams for cosmetic purposes; sun protection oils; sun protectors for lips; sun screen preparations; sun tan gel; sun tan lotion; sun tan oils; sun-tanning lotions; sunscreen; sunscreen creams; sunscreen creams for cosmetic purposes; sunscreen for cosmetic purposes; sunscreen lotions; sunscreen lotions for cosmetic purposes; toners for cosmetic use; tonic for the hair; wrinkle removing skin care preparations; wrinkle-minimizing cosmetic preparations for topical facial use

Application Number 2,049,355
International Registration Number 1548058
Language of Application English

Filing Date 2020-06-15

APPLICANT AND AGENT DETAILS

Applicant

Beijing ZeasnInformation Technology Co., Ltd
RM.305, Building 2.
NO.15, Wanyuan Street,
Beijing Economic And
Technological Development Zone,
Daxing District
100176 Beijing
CHINA

Agent

MILTONS IP/P.I.
15 Fitzgerald Rd, Suite 200, Ottawa,
ONTARIO, K2H9G1

TRADEMARK DETAILS

Trademark Type

Design

Visual Representation

ZEASN

Services

Class 42

Computer programming; updating of computer software; rental of computer software; duplication of computer programs; computer software design; maintenance of computer software; installation of computer software; development and creation of computer programmes for data processing; creating and maintaining web sites for others; consulting services in the field of software as a service (SAAS)

Application Number 2,049,651
Language of Application English

Filing Date 2020-09-02

APPLICANT DETAILS

Applicant

Shenzhen XinChuangYa Electronics Co., Ltd.
Room 1224, Block A, Jiazhaoye Center,
Shangbu South Road,
Nanyuan Street, Futian District, Shenzhen,
CHINA

TRADEMARK DETAILS

Effnny

Trademark Type

Standard Characters

Goods

Class 25

bathing suits; casual clothing; children's clothing; dresses; fleece pullovers; hats; headscarves;
hosiery; shoes; underwear

Application Number 2,049,666
Language of Application English

Filing Date 2020-09-03

APPLICANT AND AGENT DETAILS

Applicant
SHENZHEN CHENGYISHUN TECHNOLOGY
CO., LTD.
605,GONGYI BLDG NENGYUAN,SHIBIDA
BLDG
NO.55 ZHENHUA RD,HUAQIANGBEI ST
FUTIAN DIST
SHENZHEN, 518000
CHINA

Agent
YURI CHUMAK
c/o Dickinson Wright LLP, 199 Bay Street,
Suite 2200, Toronto, ONTARIO, M5L1G4

TRADEMARK DETAILS

XDO

Trademark Type
Standard Characters

Goods

Class 09

blank USB cards; blank USB flash drives; car video recorders; cases for mobile phones; cell phone battery chargers for use in vehicles; data cables; earphones and headphones; electric connectors; electrical plugs and sockets; loudspeaker cabinets; network routers; plug adapters; protective cases for smartphones; protective cases for tablet computers; protective films adapted for smart phones; smart watches; video cameras; wireless headsets for smartphones

Application Number 2,049,669
Language of Application English

Filing Date 2020-09-03

APPLICANT DETAILS

Applicant

Guangzhou Fengyuan Electronic Technology
Co., Ltd.
405-25N, 4th Floor, Building 3
No. 133 Yanling Road, Tianhe District
Guangzhou, 510000
CHINA

TRADEMARK DETAILS

X-Dowei

Trademark Type

Standard Characters

Goods

Class 09

battery chargers for cell phones; cabinets for loudspeakers; cases adapted for mobile phones; cell phone covers; data cables; leather cases for mobile phones; loudspeakers; mobile phone chargers; mobile telephone cases made of leather or imitations of leather; protective cases for mobile phones; protective cases for tablet computers; protective films adapted for smart phones; protective films adapted for smartphone screens; USB cables for mobile phones; USB chargers

Application Number 2,049,685
Language of Application English

Filing Date 2020-09-03

APPLICANT DETAILS

Applicant

Hudson Bay Distillers Inc.
NE 15 36 18 W3
366
Landis
SASKATCHEWAN
S0K2K0

TRADEMARK DETAILS

Anvia Vodka

Trademark Type
Standard Characters

Goods

Class 33

vodka

Application Number 2,049,863
Language of Application English

Filing Date 2020-09-03

APPLICANT DETAILS

Applicant
EWATCHFACTORY CORP.
390 5th Avenue, Suite 713 New York, NY
10018, U.S.A.
New York City, NY 10018
UNITED STATES OF AMERICA

TRADEMARK DETAILS

EWATCHFACTORY

Trademark Type
Standard Characters

Goods

Class 14

bands for watches; bracelets for watches; mechanical and automatic watches; watch bands; watch boxes; watch cases; watch straps; wrist watches

Application Number 2,049,864
Language of Application English

Filing Date 2020-09-03

APPLICANT DETAILS

Applicant
EWATCHFACTORY CORP.
390 5th Avenue, Suite 713 New York, NY
10018, U.S.A.
New York City, NY 10018
UNITED STATES OF AMERICA

TRADEMARK DETAILS

RED BALLOON

Trademark Type
Standard Characters

Goods

Class 14

mechanical and automatic watches; straps for watches; watch bands; watch boxes; watch bracelets; watch cases; watch straps; watches; wrist watches

Application Number 2,049,869
Language of Application French

Filing Date 2020-09-03

APPLICANT DETAILS

Applicant
VIVRE 100 FIBROMES
6646 Rue Saint-Denis
Montréal
QUÉBEC
H2S2R9

TRADEMARK DETAILS

VIVRE 100 FIBROMES

Trademark Type
Standard Characters

Services

Class 44

medical screening; medical clinic services; gynecology services; psychological care services;
human fertility treatment services; fertility treatment

Application Number 2,049,881
Language of Application English

Filing Date 2020-09-04

APPLICANT AND AGENT DETAILS

Applicant

Bright Sun Counselling Services Inc
25 Wentworth St, Dartmouth
Dartmouth
NOVA SCOTIA
B2Y2S7

Agent

MILTONS IP/P.I.
15 Fitzgerald Rd, Suite 200, Ottawa,
ONTARIO, K2H9G1

TRADEMARK DETAILS

Bright sun counselling

Trademark Type

Standard Characters

Services

Class 35

(1) accounting; administration of incentive award programmes to promote the sale of the goods and services of others; advertising agency services; advertising on the Internet for others; business management advice; conducting marketing studies; on-line advertising the goods and services of others on computer communications networks; personnel recruitment; procurement of contracts for the purchase and sale of goods and services; sales demonstration for others

Class 44

(2) animal grooming; counselling relating to holistic psychology and occupational therapy; health care services provided by a health spa; opticians' services; pet grooming; psychological assessment services; psychological care services; rental of medical equipment; services of a psychologist; speech therapy

Application Number 2,049,885
Language of Application English

Filing Date 2020-09-04

APPLICANT DETAILS

Applicant
FOOD IQ INC.
38 Sunnycrest Road
Toronto
ONTARIO
M2R2T4

TRADEMARK DETAILS

DROP NAKED

Trademark Type
Standard Characters

Goods

Class 30
chocolate and chocolates

Application Number 2,049,957
Language of Application English

Filing Date 2020-09-04

APPLICANT DETAILS

Applicant
ALL MARKET HOTEL SUPPLIES INC.
7-4090 Ridgeway Dr
Mississauga
ONTARIO
L5L5X5

TRADEMARK DETAILS

Liquid Bottle King

Trademark Type
Standard Characters

Goods

Class 11

water filtration bottles sold empty

Application Number 2,050,025
Language of Application English

Filing Date 2020-09-04

APPLICANT DETAILS

Applicant

StillWaters
Taranjit Grewal
Sukhmeet Dhur
3181 Grassie Road
Grassie
ONTARIO
L0R1M0

TRADEMARK DETAILS

StillWaters

Trademark Type
Standard Characters

Services

Class 38

streaming of audio and video via the Internet featuring music, movies, news, and sports

Application Number 2,050,048
Language of Application English

Filing Date 2020-09-04

APPLICANT AND AGENT DETAILS

Applicant

Whitewater Global Holdings LLC
1623 Central Ave
Cheyenne, WY 82001-4531
UNITED STATES OF AMERICA

Agent

GERALD E. TROTTIER
(BARTLET & RICHARDES LLP), 2565
Ouellette Avenue, Suite 100, Windsor,
ONTARIO, N8X1L9

TRADEMARK DETAILS

BLOOD RUN TACKLE

Trademark Type

Standard Characters

Disclaimer

The right to the exclusive use of the word TACKLE is disclaimed apart from the trademark.

Goods

Class 16

(1) decals

Class 25

(2) baseball caps and hats; fishing clothing; hooded pullovers; hooded sweatshirts; shirts; tee-shirts

Class 28

(3) fish hooks; fishing buoys for anglers; fishing floats; fishing hooks; fishing leaders; fishing lines; fishing reels; fishing rods; fishing sinkers; fishing spinners; fishing weights; floats for fishing; hooks for fishing; lines for fishing; reels for fishing; rods for fishing

Application Number 2,050,065
Language of Application English

Filing Date 2020-09-04

APPLICANT DETAILS

Applicant

Shenzhen Zhuangzhou Technology
Development Co., Ltd.
Blk E, F/20, Hantingxuan, Jiefang Rd,
Guiyuan St., Luohu Dist.,
Shenzhen,
CHINA

TRADEMARK DETAILS

Trademark Type

Design

Visual Representation

The trademark logo consists of the characters 'CH°NCH°W' in a stylized, outlined font. The degree symbols (°) are positioned between the 'H' and 'N', and between the 'H' and 'W'. The characters are white with black outlines.

Goods

Class 09

bags adapted for laptops; cabinets for loudspeakers; cases for smartphones; closed circuit television cameras; computer interface boards; computer keyboards; computer mouse; earphones; electric door bells; electronic weighing scales for personal use; headphones; mp4 players; smart watches; tablet computers; telescopes; virtual reality headsets; wireless headsets for use with smartphones

Application Number 2,050,082
Language of Application English

Filing Date 2020-09-05

APPLICANT DETAILS

Applicant

Ron Madore
362 Nelson St E
Alliston
ONTARIO
L9R1X6

TRADEMARK DETAILS

Trademark Type

Design

Visual Representation



Colour Claim

Colour is claimed as a feature of the trademark. The entire logo is blue

Goods

Class 28

abdominal boards for exercise; ice hockey sticks

Application Number 2,050,095
Language of Application English

Filing Date 2020-09-05

APPLICANT AND AGENT DETAILS

Applicant

Palmieri, Ezequiel AKA Ezekiel Elkin
129 Elmcroft Road
Rochester, NY 14609
UNITED STATES OF AMERICA

Agent

CHANTAL ST. DENIS
(O'BRIEN TM SERVICES INC), 262, chemin
Eardley, Gatineau, QUEBEC, J9J2Y7

TRADEMARK DETAILS

Trademark Type

Design

Visual Representation



Services

Class 41

arranging and conducting dance festivals; arranging and conducting musical concerts; audio and video recording services; composition of music; entertainment in the form of dance performances; entertainment in the form of laser shows; entertainment in the form of live comedy shows; entertainment in the form of live musical concerts; entertainment in the form of live performances by a musical band; entertainment in the form of magic shows; entertainment in the form of opera productions; entertainment in the form of orchestra performances; entertainment in the form of personal appearances by a sports celebrity or movie star; entertainment in the form of puppet shows; entertainment in the form of television shows; entertainment in the form of theatre productions; entertainment in the nature of theater productions; entertainment services in the nature of live dramatic performances; entertainment services in the nature of live musical plays; entertainment services in the nature of live performances by a musical band; entertainment services in the nature of live theatrical performances; entertainment services in the nature of non-downloadable television shows and movies transmitted via the internet; entertainment services in the nature of non-downloadable videos and images featuring television shows and movies transmitted via wireless computer networks; film and video production; film production; film studios;

instruction in the field of music; music composition; music composition services; music instruction; music transcription; music transcription for others; music-halls; organization of music concerts for charitable purposes; organizing community festivals; organizing ethnic festivals; organizing music competitions; performances featuring live dance and live music; presentation of live comedy shows; presentation of live performances in the form of opera; presentation of live performances, in the form of ballets; production and distribution of radio programmes; production of ballet performances; production of films; production of laser light shows; production of live comedy shows; production of live musical variety shows; production of magic shows; production of motion picture films; production of movie special effects; production of music records; production of musical videos; production of news webcasts; production of puppet shows; production of radio and television programmes; production of radio and television programs; production of radio programs; production of television and radio programmes; production of television programs; production of theatre shows; radio programming; record master production; record mastering; record production; recording studio services; screenplay writing; scriptwriting services; songwriting; sound engineering services for events; television programming; theatre management; theatre productions; theatrical shows provided at performance venues; video film production; video production; video recording services; video tape film production; writing screenplays

Application Number 2,050,101
Language of Application English

Filing Date 2020-09-06

APPLICANT DETAILS

Applicant

Xiaohong LIU
No.9 Zhanghutuo, Zhanghutuo Village,
Xiaoshidian Town,
Fangcheng County, Henan Province,
CHINA

TRADEMARK DETAILS

Trademark Type

Design

Visual Representation

The logo for BROSAN GOLF features the word "BROSAN" in a large, bold, italicized sans-serif font. Below it, the word "GOLF" is written in a smaller, all-caps, spaced-out sans-serif font. The entire logo is underlined with a thick black line.

Disclaimer

The right to the exclusive use of the word golf is disclaimed apart from the trademark.

Goods

Class 25

(1) athletic clothing; baby clothing; business clothing; caps; caps with visors; casual clothing; children's clothing; clothing belts; clothing for gymnastics; clothing in particular pants; clothing in the nature of pants; gloves; golf caps; golf footwear; golf jackets; golf pants; golf shirts; golf shoes; golf skirts; golf trousers; golf wear; hats; lace boots; mittens; ski gloves; sports footwear; sports jerseys; sports shoes; sports uniforms; tee-shirts; visors for athletic use; waistcoats

Class 28

(2) ball pitching machines; covers for golf clubs; gloves for golf; golf bag carts; golf bags; golf bags with or without wheels; golf ball markers; golf ball retrievers; golf balls; golf club heads; golf clubs; golf divot repair tool; golf markers; golf putters; golf putting aids; golf sticks; grips for rackets; gut for rackets; markers for golf balls; overgrips for rackets; practice nets for golf; protective covers for rackets; shaped covers for golf putters; vibration dampeners for rackets

Application Number 2,050,114
Language of Application English

Filing Date 2020-09-07

APPLICANT DETAILS

Applicant

Mark Frezell Incorporated
76 Midpark Drive SE
Calgary
ALBERTA
T2X1S8

TRADEMARK DETAILS

Trademark Type

Design

Visual Representation

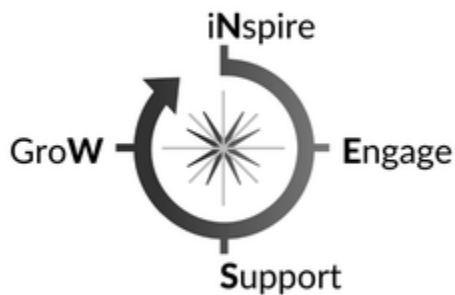

Services

Class 35

advice relating to the organisation and management of business; business management consultancy as well as development of processes for the analysis and the implementation of strategy plans and management projects; business management consultancy via the Internet; business organization and management consultancy including personnel management; business strategy development services; consultancy and advisory services in the field of business strategy; consultancy relating to personnel management; consulting services in business organization and management; human resources management

Application Number 2,050,115
Language of Application English

Filing Date 2020-09-07

APPLICANT DETAILS

Applicant

Xiaohong LIU
No.9 Zhanghutuo, Zhanghutuo Village,
Xiaoshidian Town,
Fangcheng County, Henan Province,
CHINA

TRADEMARK DETAILS

Trademark Type

Design

Visual Representation



Goods

Class 25

(1) athletic clothing; baby clothing; business clothing; caps; caps with visors; casual clothing; children's clothing; clothing belts; clothing for gymnastics; clothing in particular pants; clothing in the nature of pants; gloves; golf caps; golf footwear; golf jackets; golf pants; golf shirts; golf shoes; golf skirts; golf trousers; golf wear; hats; lace boots; mittens; ski gloves; sports footwear; sports jerseys; sports shoes; sports uniforms; tee-shirts; visors for athletic use; waistcoats

Class 28

(2) ball pitching machines; covers for golf clubs; gloves for golf; golf bag carts; golf bags; golf bags with or without wheels; golf ball markers; golf ball retrievers; golf balls; golf club heads; golf clubs; golf divot repair tool; golf markers; golf putters; golf putting aids; golf sticks; grips for rackets; gut for rackets; markers for golf balls; overgrips for rackets; practice nets for golf; protective covers for rackets; shaped covers for golf putters; vibration dampeners for rackets

Application Number 2,050,121
Language of Application English

Filing Date 2020-09-07

APPLICANT DETAILS

Applicant

Maison De Mioche Inc.
1801-1 Yonge St
Toronto
ONTARIO
M5E1W7

TRADEMARK DETAILS

Trademark Type

Design

Visual Representation



Goods

Class 18

(1) all-purpose athletic bags; animal leads; baby backpacks; baby changing bags; bags for carrying animals; clothing for animals; collars for dogs; dog apparel; duffle bags; infant carriers worn on the body; leashes for pets; schoolchildren's backpacks; wallets

Class 25

(2) adult sweatpants; athletic apparel; athletic footwear; baby clothing; bathing suits; children's clothing; children's footwear; hats; hooded sweatshirts; infant footwear; pyjamas; shorts; socks; sweatshirts; underwear

Services

Class 35

online sales of clothing; online sales of footwear; online sales of headwear

Application Number 2,050,123
Language of Application English

Filing Date 2020-09-07

APPLICANT DETAILS

Applicant

Maison De Mioche Inc.
1801-1 Yonge St
Toronto
ONTARIO
M5E1W7

TRADEMARK DETAILS

Trademark Type

Design

Visual Representation



Goods

Class 18

(1) all-purpose athletic bags; animal leads; baby backpacks; baby changing bags; bags for carrying animals; clothing for animals; collars for dogs; dog apparel; duffle bags; infant carriers worn on the body; leashes for pets; schoolchildren's backpacks; wallets

Class 25

(2) adult sweatpants; athletic apparel; athletic footwear; baby clothing; bathing suits; children's clothing; children's footwear; hats; hooded sweatshirts; infant footwear; pyjamas; shorts; socks; sweatshirts; underwear

Services

Class 35

online sales of clothing; online sales of footwear; online sales of headwear

Application Number 2,050,189
Language of Application English

Filing Date 2020-09-08

APPLICANT AND AGENT DETAILS

Applicant

Mensa Brand Technologies Private Limited
No. 39, 2nd Floor, Suite #652, NGEF Lane
Indiranagar First Stage
Bangalore, Karnataka, 560038
INDIA

Agent

BERESKIN & PARR LLP/S.E.N.C.R.L., S.R.L.
SCOTIA PLAZA, 40 KING STREET WEST,
40th FLOOR, TORONTO, ONTARIO, M5H3Y2

TRADEMARK DETAILS

ESTALON

Trademark Type

Standard Characters

Goods

Class 18

bags of leather; belt bags; billfolds; card wallets; coin purses made of leather; credit card cases of leather; credit card holders; credit card holders of leather; credit card wallets; credit card wallets of leather; cross-body bags; document cases; duffel bags; duffel bags for travel; face masks for equines; handbags made of imitation leather; handbags made of leather; handbags, purses and wallets; key cases of leather; key cases of leather or imitation leather; key pouches; key wallets; key-cases; labels of leather; ladies' handbags; leather and imitation leather; leather bags for packaging; leather boxes; leather briefcases; leather cases; leather cases for keys; leather coin purses; leather cords; leather credit card cases; leather credit card holder; leather credit card holders; leather credit card wallets; leather envelopes for merchandise packaging; leather for furniture; leather for harnesses; leather for shoes; leather handbags; leather hat boxes; leather key cases; leather leashes; leather luggage straps; leather luggage tags; leather notecases; leather pouches; leather pouches for merchandise packaging; leather purses; leather shopping bags; leather shoulder belts; leather sold in bulk; leather straps; leather suitcases; leather thongs; leather thread; leather tool bags; leather travelling bags; leather travelling suitcases; leather trimmings for furniture; luggage tags for travel baggage; luggage tags made of leather; make-up bags; plastic luggage labels; plastic luggage tags; pocket wallets; purses; shoulder bags; shoulder belts of leather; shoulder straps; shoulder straps of leather; small bags for men; small coin purses; small handbags; synthetic fur; synthetic leather; tanned leather; textile shopping bags; toilet bags; toiletry bags; toiletry cases sold empty; tool bags of leather; travel wallets; travelling bags; trolley bags; trolley duffel bags; waist bags; waist pouches; wallets; wallets for attachment to belts; wallets including card holders; wallets of precious metal; wallets with card compartments; wash bags for carrying toiletries; wrist-mounted money purses; wrist-mounted wallets

Application Number 2,050,212
Language of Application English

Filing Date 2020-09-08

APPLICANT DETAILS

Applicant

Edward Walter Bieber
635 Anderton Rd
Comox
BRITISH COLUMBIA
V9M2J1

TRADEMARK DETAILS

Groovy Beaver

Trademark Type

Standard Characters

Goods

Class 09

(1) dust masks; dust protection masks; dust protective masks

Class 21

(2) water bottles

Application Number 2,050,288
Language of Application English

Filing Date 2020-09-08

APPLICANT DETAILS

Applicant

2549643 Ontario Inc.
80 King High Drive
Vaughan
ONTARIO
L4J3N4

TRADEMARK DETAILS

dentawhite

Trademark Type

Standard Characters

Goods

Class 03

chewing gum for whitening teeth; cosmetic teeth whitening strips impregnated with teeth whitening preparations; teeth cleaning lotions; teeth whitener; teeth whitening strips; tooth whitening creams; tooth whitening gels; tooth whitening pastes; tooth whitening preparations

Services

Class 44

dental assistance; dental clinics; dental consultations; dental hygienist services; mobile dental care services; teeth whitening; teeth whitening services

Application Number 2,050,292
Language of Application English

Filing Date 2020-09-08

APPLICANT DETAILS

Applicant

Bike Echo Sports Ltd.
12-22788 Westminster HWY
V6V0B1
Richmond
BRITISH COLUMBIA
V6V0B1

TRADEMARK DETAILS

Trademark Type

Design

Visual Representation

BIKECHO

Goods

Class 12

adhesive rubber patches for repairing inner tubes; adhesive rubber patches for repairing tubes or tires; aerial conveyors; aero-dynamic fairings for vehicles; aeroplane towing vehicles; aeroplanes; agricultural tractors; air bags for automobiles; air balloons; air cushion vehicles; air pumps for automobiles; air pumps for bicycles; air pumps for motorcycles; air pumps for two-wheeled motor vehicles and bicycles; air pumps of automobiles; air pumps of two-wheeled motor vehicles; air springs for vehicle suspension components for cushioning driver's seats and cabs; air turbines for land vehicles; air-cushion vehicles; airbags for vehicles; aircraft; aircraft carriers; aircraft fuselages; aircraft landing gear; aircraft landing gear wheels; aircraft propellers; airplane landing gear wheels; airplane propellers; airplane seats; airplane spinners; airplanes; airships; all-terrain vehicles; ambulances; amphibious airplanes; amphibious vehicles; anti-skid chains; anti-skid chains for vehicle tires; anti-skid chains for vehicles; anti-skid studs for vehicle tires; anti-skid textile covers for tires; anti-theft alarms for vehicles; anti-theft devices for motor cars; anti-theft locks for use on automobile steering wheels; anti-theft warning apparatus for motor cars; arm rests for vehicles; armored vehicles; armoured bodies for vehicles; armoured cars; armoured land vehicles; armoured vehicles; ashtrays for automobiles; autogyros; automatic gearboxes for land vehicles; automatic guided vehicles; automatically guided driverless material handling tractors; automatically guided material handling trucks; automobile bodies; automobile bumpers; automobile chains; automobile chassis; automobile door handles; automobile engines; automobile hoods; automobile roof containers; automobile roof racks; automobile seat cushions; automobile ski racks; automobile spare wheel holders; automobile sunroofs; automobile suspension spindle; automobile suspension spindles; automobile tires; automobile tyres; automobile windscreens; automobile windshield sunshades; automobile windshields; automobiles; automobiles for the physically handicapped and

those of reduced mobility; automotive interior trim; automotive shock absorbing springs; automotive suspension springs; autonomous underwater vehicles for seabed inspections; axle bearings for motor vehicles; axle boxes for rail cars; axle journals; axles and cardan shaft for motor vehicles; axles for air suspension systems in vehicles; axles for land vehicles; baby buggy bumpers; baby carriages; baby prams; baby strollers; bags adapted for pushchairs; bags adapted for strollers; balance weights for vehicle wheels; band brakes for land vehicles; bands for wheel hubs; barges; baskets adapted for bicycles; bellows for articulated buses; bells for motorcycles; belt pulleys for land vehicles; bicycle bells; bicycle bottom bracket spindle; bicycle brake lever grips; bicycle brakes; bicycle carriers; bicycle chains; bicycle cranks; bicycle frames; bicycle frames and bicycle handlebar grips; bicycle handle bars; bicycle handlebar grips; bicycle handlebars; bicycle handles; bicycle horns; bicycle kickstands; bicycle motors; bicycle mudguards; bicycle parts; bicycle pedals; bicycle pumps; bicycle rims; bicycle saddles; bicycle seats; bicycle spokes; bicycle stands; bicycle tires; bicycle trailers; bicycle trailers [riyakah]; bicycle tyres; bicycle wheel hubs; bicycle wheel rims; bicycle wheel spokes; bicycle wheels; bicycle wheels, rims and structural parts therefor; bicycles; bikes; block brakes for land vehicles; block brakes for machines; boat building kits; boat bumpers; boat canopies; boat chocks; boat davits; boat fenders; boat hooks; boat propellers; boat rigs; boat tillers; boat trailers; boat-hooks; boats; bodies for railway cars; bodies for vehicles; body panels for vehicles; bogies for railway cars; booms for boats; brake blocks; brake blocks for land vehicles; brake cylinder repair kits; brake cylinders; brake discs; brake discs for vehicles; brake disks; brake drums; brake drums for vehicles; brake facings; brake facings for vehicles; brake levers; brake linings; brake linings for land vehicles; brake linings for motor cars; brake linings for vehicles; brake pads for automobiles; brake pads for land vehicles; brake pucks; brake segments for motor cars; brake segments for vehicles; brake shoes; brake shoes for land vehicles; brake shoes for motor cars; brake shoes for vehicles; brake systems for motor vehicles; brakes for aircrafts; brakes for motor cars; brakes for motor vehicles; brakes for vehicles; braking systems for motor vehicles and parts thereof; buffers for railway rolling stock; bumpers for automobiles; buses; cable cars; cable ships; camera drones; camper vans; camping trailers; canoe paddles; canoes; caps for vehicle fuel tanks; caps for wheel rims; car doors; car horns; car seat covers; car seat harnesses; car suspension spindle; car suspension spindles; car windows; car-top luggage carriers; caravans; cargo ships; cargo trailers; cars; cars for cable transport installations; cement mixers; chain guards for bicycles; chains for motor cars; chair lifts; chairlifts; chassis for automobiles; chassis for motor vehicles; chassis for railway cars; child car seats; child safety harnesses for vehicle seats; child safety restraints for bicycles; child safety restraints for vehicle seats; children's car seats; children's safety seats for cars; children's safety seats for vehicles; cigar lighters for automobiles; civilian drones; clutch mechanisms for motor cars; clutches for motor vehicles; collapsible bicycles; concrete mixing vehicles; cone brakes for land vehicles; construction tractors; convertible tops for vehicles; covers for baby carriages; covers for vehicle steering wheels; cranks for cycles; davits for boats; delivery bicycles; delivery drones; delivery tricycles; diesel engines for land vehicles; diesel motors for land vehicles; dining cars; direction indicators for bicycles; direction signals for automobiles; direction signals for vehicles; directional signals for vehicles; dirigible balloons; disc brakes for land vehicles; disengaging gear for boats; dog guards for use in vehicles; dog racing sleds; dollies; doors for automobiles; doors for railway cars; doors for vehicles; dredgers; dress guards for bicycles; drive belts; drive gears; drive-chain guards for two-wheeled motor vehicles; driverless cars; driverless material handling trucks; driving chains for land vehicles; driving motors for land vehicles; dump cars; dump carts; dump trucks; dune buggy steering brakes; ejector seats for aircraft; electric bicycles; electric cars; electric drives for vehicles; electric locomotives; electric motors for motor cars; electric railway cars; electric reversing alarms for vehicles; electric scooters; electric steering gears for vessels; electrical anti-theft installations for vehicles; electrically powered aircraft; electrically powered

buses; electrically powered motor scooters; electrically powered motor vehicles; engine mounts for land vehicles; engines for land vehicles; fenders for ships; ferry boats; fishing boats; fishing trolleys; fitted covers for boats; fitted covers for vehicle steering wheels; fitted footmuffs for baby carriages; fitted footmuffs for prams; fitted footmuffs for pushchairs; fitted footmuffs for strollers; fitted motorcycle covers; fitted perambulator covers; fitted pushchair mosquito nets; fitted stroller mosquito nets; fitted vehicle covers for automobiles; fitted vehicle seat covers; flanges for railway wheel tires; flanges for railway wheel tyres; flanges of railway wheel tires; folding bikes; fork lift trucks; fork tines for forklifts; forklift trucks; frames for bicycles; frames for luggage carriers; frames for motorcycles; freewheels for bicycles; freewheels for motorcycles; front forks for bicycles; front forks for cycles; front forks for forklifts; front forks for motorcycles; front forks for snowmobiles; front forks for two-wheeled vehicles; fuel tanks; fuel tanks for aircraft; funicular railcars; funiculars; funnels for locomotives; funnels for ships; fuselages of aircraft; garbage trucks; garden tractors; garden tractors for transport; gas turbines for land vehicles; gasoline engines for land vehicles; gear boxes for land vehicles; gear lever knobs; gear lever knobs for vehicles; gear shifts; gear wheels; gear wheels for land vehicles; gearboxes; gearboxes for land vehicles; gearboxes for motor cars; gears for bicycles; glider aircraft; gliders; go-carts; go-kart transport trucks; go-karts; golf carts; grocery carts; ground effect vehicles; hand trucks; handbrake knobs; handbrake knobs for vehicles; handle bars for bicycles; handle bars for motorcycles; handlebar controls for mopeds; handlebar grips for bicycles; handlebar grips for motorcycles; handlebars; handlebars of two-wheeled motor vehicles or bicycles; handling carts; hatch boards; head restraints for vehicles; head rests for seats for motor cars; head-rests for vehicle seats; headlight wipers; hearses; heel guards for motorcyclists; helicams; helicopters; hoods for baby carriages; hoods for vehicle engines; hoods for vehicles; horns for motor cars; horns for motor vehicles; horse carriages; horse drawn carriages; horse trailers; horse-drawn sleighs; hose carts; hospital carts; hospital carts for dispensing medication; hot air balloons; house boats; house trailers; hovercraft; hub caps; hubs for bicycle wheels; hubs for motorcycle wheels; hubs for vehicle wheels; hybrid cars; hydraulic circuits for motor cars; hydraulic circuits for vehicles; hydraulic rim brakes; hydraulic torque converters for land vehicles; hydraulic turbines for land vehicles; hydrofoils; hydroplanes; idling pulleys for land vehicles; inclined ways for boats; inflatable air bags for use in vehicles for the prevention of injury in accidents; inner tubes for aircraft tires; inner tubes for aircraft wheel tires; inner tubes for automobile tires; inner tubes for bicycle tires; inner tubes for bicycle tyres; inner tubes for bicycles; inner tubes for motorcycle tires; inner tubes for pneumatic tires; inner tubes for pneumatic tyres; inner tubes for the wheels of forestry vehicles; inner tubes for tires; inner tubes for two-wheeled motor vehicles; internal combustion engines for land vehicles; internal combustion engines for motor vehicles; internal combustion locomotives; internal combustion railcars; Japanese flat-bottomed rowboats [tenmasen]; jet aircraft; kayak paddles; kayaks; kick sledges; kickstands; ladle carriages; ladle cars; landing gear wheels for aircraft; landing gear wheels of aircraft; license plate holders; light aircraft; light lorries; light trucks; locomotives; lorries for mines; lug nuts for vehicle wheels; luggage carriers for automobiles; luggage carriers for vehicles; luggage nets for vehicles; luggage racks fitted to the bonnet; luggage racks for bicycles; luggage racks for motor cars; luggage racks for motorcycles; luggage trucks; main brake cylinders; manual wheelchairs; masts for boats; mechanics' creepers; military drones; mine cars; mine cart wheels; mine-car pullers; mine-car pushers; mini-bikes; minibuses; minivans; mobile home caravans; mobility scooters; mopeds; motor buses; motor car convertible tops; motor car doors; motor car seats; motor car windows; motor cars; motor cars for transport on land; motor coaches; motor homes; motor racing cars; motor scooters; motor vehicle engines; motor vehicle hood scoops; motor vehicle mudguards; motorboats; motorcycle chains; motorcycle drive chains; motorcycle engines; motorcycle foot pegs; motorcycle frames; motorcycle grip tape; motorcycle handlebars; motorcycle kickstands; motorcycle saddlebags; motorcycle saddles; motorcycle sidecars; motorcycle tires;

motorcycles; motorcycles for motocross; motorised wheelchairs for the disabled and those with mobility difficulties; motorized bicycles; motorized golf trolleys; motorized wheelchairs; mountain bicycles; moving vans; mudguards; mudguards for automobiles; mudguards for bicycles; mudguards for motorcycles; mudguards for two-wheeled motor vehicles; mudguards of two-wheeled motor vehicles or bicycles; non-motorized push scooters; oarlocks; oars; ocean kayak; omnibuses; outriggers for watercraft; padding for infant car seats; paddles for canoes; panniers adapted for cycles; panniers adapted for motorcycles; parachute harnesses; parachutes; parachutes for arresting the motion of vehicles; parachutes for sky-diving; pedals for motorcycles; pet strollers; petrol tank caps for motor cars; photography drones; pickup trucks; pilot ejector seats; platform trucks; pneumatic tires; pneumatic tyres; pneumatic tyres and inner tubes for motorcycles; pontoon boats; pontoons; portholes; portholes for vessels; prams; propeller airplanes; protective liners for cargo area of vehicles; pumps for bicycle tires; pumps for bicycle tyres; push chairs; push scooters; pushchair covers; pushchair hoods; racing bicycles; racing cars; racing motor cars; rail cars; railcar suspension spindle; railway car wheels; railway carriages; railway cars; railway couplings; railway freight cars; railway passenger cars; railway rolling stock; rear view mirrors; rear wheel sprockets; rearview mirrors; rearview mirrors for automobiles; rearview mirrors of automobiles; reduction gears for land vehicles; refrigerated railroad car; refrigerated railway wagons; refrigerated trailers; repair outfits for inner tubes; reversing alarms for vehicles; reversing gears for land vehicles; rickshaws; rims for bicycle wheels; road racing bicycles; robotic cars; rocket thrusters; roll cage trolleys; roller bearings for motor vehicles; roller chains for forklifts; roller chains for land vehicles; rolling stock for funicular railways; rolling stock for railways; roof bars for vehicles; roof boxes for vehicles; roof racks for vehicles; rowboats; rowlocks; rubbish trucks; rudders for vessels; sack-barrows; saddle covers for bicycles; saddle covers for motorcycles; saddlebags adapted for bicycles; saddles for bicycles; saddles for motorcycles; safety belts for vehicle seats; safety belts for vehicles for motor cars; safety seats for children for motor cars; safety seats for infants and children for vehicles; sailboats; sailing vessels; sailplanes; screw propellers for vessels; screw-propellers; screw-propellers for boats; sculls; seaplanes; seat belt buckles; seat belts; seat covers for vehicles; seat safety harnesses for motor cars; seats for automobiles; seats for railway cars; security alarms for vehicles; security harness for vehicle seats; self-balancing boards; self-balancing electric scooters; self-balancing electric unicycles; self-balancing scooters; self-driving cars; self-generating electric locomotives; self-propelled electric platform truck; semi-tractor trailers; semi-trailer; semi-trailer trucks; shaft couplings for land vehicles; shift boots for motor vehicles; ship ballast tanks; ship hulls; ships; ships' hulls; ships' steering gears; shock absorbers for automobiles; shock absorbers for bicycles; shock absorbers for cars; shock absorbers for motor vehicles; shock absorbing springs for motor cars; shock absorbing springs for vehicles; shopping carts; shopping trolleys; side view mirrors for vehicles; ski carriers for automobiles; ski carriers for cars; ski carriers for motor cars; ski carriers for vehicles; ski lifts; ski racks; ski racks for motor cars; skiffs; sleeping berths for vehicles; sleeping cars; small wagons for children; snow chains; snowmobiles; solid tires for vehicle wheels; solid tyres for vehicle wheels; space vehicles; spare tire carriers for vehicles; spare tire covers; spare tyre covers; spare wheel covers; spars for ships; speed change gears for land vehicles; spikes for tires; spikes for tyres; spinnaker poles; spoilers for airplanes; spoilers for automotive vehicles; spoilers for motor vehicles; spoilers for vehicles; spoke clips for wheels; spokes for automobiles; spokes for bicycle wheels; spokes for bicycles; spokes for motorcycles; spokes for two-wheeled motor vehicles; sport utility vehicles; sports cars; sprinkling trucks; steam locomotives; steam steering gears and rudders for vessels; steam steering gears for vessels; steam turbines; steam turbines for land vehicles; steel hatch covers for vessels; steering gears and rudders for vessels; steering gears for ships; steering wheel covers; steering wheel covers for automobiles; steering wheels; steering wheels for automobiles; steering wheels for cars; steering wheels for vehicles; steering

wheels for vessels; stern oars; stroller covers; stroller hoods; strollers; structural parts for automobiles; sun blinds for automobiles; sun shields and visors for motor cars; suspension arms for cable cars; suspension shock absorbers for vehicles; suspension springs for motor cars; suspension systems for motor vehicles; t bars for ski lifts; tandem bicycles; tilt rotor aircraft; tilt trucks; tilting-carts; tipping bodies for lorries; tipping bodies for trucks; tire inflators; tire mousse inserts; tire patches; tires; tires for aircraft landing gear wheels; tires for automobiles; tires for bicycles; tires for children's' bicycles; tires for landing gear wheels for aircraft; tires for two-wheeled motor vehicles; tires for two-wheeled motor vehicles or bicycles; tires for wheels of aircraft; torque converters for motor cars; torsion bars for motor cars; touring bicycles; tow bars; tow bars for trailers; tow hooks; tow trucks; tow-bars; traction engines; tractor saddles; tractor steering brakes; tractor trailers; tractors; trailer couplings; trailer hitches; trailer hitches for vehicles; trailer wheels; trailers for transporting bicycles; train carriages; tramcars; transmission belts for land vehicles; transmission chains for land vehicles; transmission mechanisms for land vehicles; transmission rebuild kits for land vehicles; transmission shafts for land vehicles; transmissions for land vehicles; transmissions for motor vehicles; travel trailers; treads for retreading tires; treads for retreading tires for civil engineering vehicles; treads for retreading tyres; treads for retreading tyres for forestry vehicles; treads for retreading tyres for vehicles used in the civil engineering industry; tricycles; trolley buses; truck bodies; trucks; tubeless tires for bicycles; tubeless tyres for bicycles; tubular tires; tubular tyres; tug boats; turbines for locomotives; turbo-jet airplanes; turbo-prop airplanes; turbojet engines for land vehicles; turn signals for vehicles; two-wheeled trolleys; tyre mousse inserts; tyres and inner tubes for the wheels of forestry vehicles; tyres for agricultural vehicles; tyres for aircraft; tyres for buses; tyres for commercial vehicles; tyres for trucks; tyres for two-wheeled vehicles; undercarriages for vehicles; undercarriages of railway cars; unmanned aerial vehicles (UAVs); upholstery for vehicles; valves for vehicle tires; valves for vehicle tyres; vans; vehicle alarms; vehicle bodies; vehicle bonnet pins; vehicle brake discs; vehicle brake pads; vehicle bumpers; vehicle chassis; vehicle covers; vehicle hood pins; vehicle hoods; vehicle joysticks; vehicle luggage carriers; vehicle roof bars; vehicle roof boxes; vehicle running boards; vehicle seats; vehicle suspension springs; vehicle wheel hubs; vehicle wheel rims; vehicle windshield sunshades; vessels in the form of boats and ships; waggons; wagons; warning horns for automobiles; warning horns for motorcycles; water bikes; wheel arch extensions; wheel bearings for motor vehicles; wheel hubs of two-wheeled motor vehicles or bicycles; wheel rims for automobiles; wheel rims for motor cars; wheel rims for motor vehicles; wheel rims of two-wheeled motor vehicles or bicycles; wheel sprockets; wheelbarrows; wheelchairs; wheels for automobiles; wheels for motor vehicle; wheels for motorcycles; wheels of automobiles; wheels of railway cars; windows for vehicles; windscreen wipers; windscreen wipers for automobiles; windscreen wipers for motor cars; windcreens; windcreens for motor cars; windcreens for vehicles; windshield wiper blades; windshield wipers; windshields; wings for aircraft; wreckers for transport; yachts

Application Number 2,050,297
Language of Application English

Filing Date 2020-09-08

APPLICANT DETAILS

Applicant

Shuzhong Li
67 Shellamwood Trail
Toronto
ONTARIO
M1S2M9

TRADEMARK DETAILS

Haigle

Trademark Type

Standard Characters

Services

Class 35

(1) business administration services; business management for shops; business management services; commercial assistance in business management; commercial business management; commercial business management services; computer database management services; computer file management; computerised file management; computerized business file management; computerized database management; computerized file management; computerized market research services; on-line advertising for others on computer networks; on-line advertising the goods and services of others on computer communications networks; online advertising for others via a computer communications network; online department store services; online retail services for downloadable and pre-recorded music and movies; online retail services for downloadable digital music; online sales of sporting goods

Class 41

(2) book publishing; computer training; conducting courses of instruction at the college level; conducting courses of instruction at the high school level; conducting courses of instruction at the primary level; conducting distance learning at the College level; conducting distance learning at the high school level; conducting distance learning instruction at the college level; conducting distance learning instruction at the university level; conducting fitness classes; correspondence courses at the high school level; correspondence courses in the field of language training; correspondence courses in the field of technical writing; dance instruction; dance instruction for adults; developing educational manuals; developing fitness programs; electronic desktop publishing; film and video production; fitness training; instruction in martial arts; instruction in the field of art; instruction in the field of music; online electronic publishing of books and periodicals; online library services; online publication of electronic books and periodicals; production of musical videos; providing correspondence courses featuring language training; providing information about degree credit courses and online education; publishing of books and reviews; publishing of electronic publications; publishing of text books; teaching computer programming; teaching physical fitness; video production

Application Number 2,050,313
Language of Application English

Filing Date 2020-09-08

APPLICANT AND AGENT DETAILS

Applicant

Shenzhen Jiuqi Electronic Business Co., Ltd.
Room 3602, Building 4, Jinyu Central Garden
Phase II, No. 155, Bulong Road
Shuijing Community, Jihua Street, Longgang
District
Shenzhen, 518000
CHINA

Agent

YURI CHUMAK
c/o Dickinson Wright LLP, 199 Bay Street,
Suite 2200, Toronto, ONTARIO, M5L1G4

TRADEMARK DETAILS

ARKARTECH

Trademark Type

Standard Characters

Goods

Class 09

bathroom scales; camera tripods; computer keypads; computer mouse; digital camera lights; electronic weighing scales for kitchen use; headphones; headsets; mobile phone chargers; smart watches; telephone headsets; video monitors; virtual reality headsets; wireless headsets for smartphones; wireless headsets for use with mobile phones

Application Number 2,050,314
Language of Application English

Filing Date 2020-09-08

APPLICANT AND AGENT DETAILS

Applicant

Shenzhen Kaiou E-commerce Co., Ltd.
Room A423, Building C, Guanghong Meiju
No. 163, Pingxin North Road, Hehua
Community
Pinghu Street, Longgang District
Shenzhen, 518000
CHINA

Agent

YURI CHUMAK
c/o Dickinson Wright LLP, 199 Bay Street,
Suite 2200, Toronto, ONTARIO, M5L1G4

TRADEMARK DETAILS

Micolindun

Trademark Type

Standard Characters

Goods

Class 09

bathroom scales; camera tripods; computer keypads; computer mouse; digital camera lights; electronic weighing scales for kitchen use; headphones; headsets; mobile phone chargers; smart watches; telephone headsets; video monitors; virtual reality headsets; wireless headsets for smartphones; wireless headsets for use with mobile phones

Application Number 2,050,333
Language of Application English

Filing Date 2020-09-09

APPLICANT DETAILS

Applicant

Didi Roberts
Katarzyna Klepadlo
250 Wharncliffe Rd N
London
ONTARIO
N6H2B8

TRADEMARK DETAILS

In Good Style

Trademark Type

Standard Characters

Goods

Class 18

(1) fashion handbags

Class 25

(2) athletic clothing; baseball caps and hats; baseball shirts; button down shirts; casual clothing; casual shirts; children's clothing; children's shirts; cloth hats; collared shirts; denim shirts; dress shirts; fashion hats; fleece shirts; fur hats; golf hats; golf shirts; hats; jackets; knit shirts; knitted shirts; long sleeve shirts; long-sleeved t-shirts; men's shirts; polo shirts; promotional t-shirts; tee-shirts; tennis shirts; women's shirts

Services

Class 35

(1) advertising of commercial real estate for others; advertising of residential real estate for others; real estate advertising services for others

Class 36

(2) financial analysis and research services; financial analysis consultation services; real estate agencies; real estate agency services

Class 41

(3) entertainment services in the nature of non-downloadable videos and images featuring television shows and movies transmitted via wireless computer networks; film and video production; fitness training; health clubs

Class 42

(4) interior decorating; interior design; interior design services

Class 44

(5) consultancy relating to landscape design; health and beauty care services provided by saunas, beauty salons, sanatoriums, hairdressing salons and massage parlors; landscape design;

landscape design and gardening services; landscape gardening; landscape gardening design for others

Class 45

(6) personal fashion consulting services

Application Number 2,050,440
Language of Application English

Filing Date 2020-09-09

APPLICANT DETAILS

Applicant
B A I BRAGONIER & ASSOCIATES INC.
2439 Morrison Ave
Mississauga
ONTARIO
L5C3E7

TRADEMARK DETAILS

ClientDocs

Trademark Type
Standard Characters

Services

Class 45

advisory services relating to intellectual property rights; consultancy relating to the management of intellectual property; intellectual property consultancy; providing information in the field of intellectual property

Application Number 2,050,494
Language of Application English

Filing Date 2020-09-09

APPLICANT DETAILS

Applicant
GRINDSTATE INC.
55 Erskine Ave
Toronto
ONTARIO
M4P1Y7

TRADEMARK DETAILS

Trademark Type
Design

Visual Representation



Goods

Class 25

athletic apparel; athletic clothing; business attire; business clothing; casual clothing; casual clothing featuring pants, dresses and shorts; casual footwear; casual pants; casual shirts; casual wear

Application Number 2,050,854
Language of Application English

Filing Date 2020-09-09

APPLICANT DETAILS

Applicant

BeTheOne Ltd.
423 Bristol Road West
Mississauga
ONTARIO
L5R3R7

TRADEMARK DETAILS

Trademark Type

Design

Visual Representation

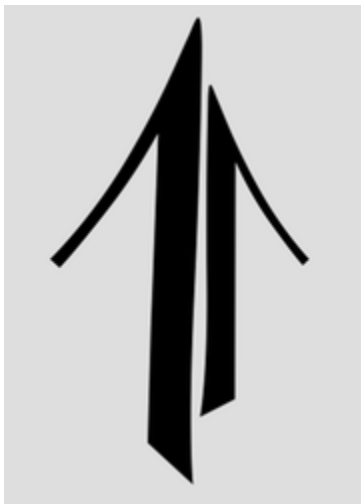

Goods

Class 25

athletic clothing; beach clothes; casual clothing featuring pants, dresses and shorts; sports clothing

Services

Class 35

online sales of clothing; online sales of headwear

Application Number 2,050,865
Language of Application English

Filing Date 2020-09-10

APPLICANT DETAILS

Applicant
LATIFI,AMINE
10240 Rue Meilleur
Montréal
QUEBEC
H3L3J9

TRADEMARK DETAILS

Trademark Type
Design

Visual Representation



Services

Class 35

online department store services; online sales of sporting goods; product demonstrations of kitchen appliances; sales demonstrations of kitchen appliances

Application Number 2,050,950
Language of Application English

Filing Date 2020-09-10

APPLICANT AND AGENT DETAILS

Applicant

Willow Personal Development and End of Life
Education Enterprises
404-1855 Nelson St
Vancouver
BRITISH COLUMBIA
V6G1M9

Agent

HOFFER ADLER LLP
1102-595 Bay Street, Toronto, ONTARIO,
M5G2C2

TRADEMARK DETAILS

Reality Of Our Mortality

Trademark Type

Standard Characters

Services

Class 41

(1) workshops and seminars in the field of will and estate planning

Class 45

(2) providing on-line information in the field of spirituality, self-help, and personal empowerment subject matters

Application Number 2,050,951
Language of Application English

Filing Date 2020-09-10

APPLICANT DETAILS

Applicant

CardioMed Supplies Inc
199 Saint David Street
Lindsay
ONTARIO
K9V5K7

TRADEMARK DETAILS

VIVOCATH

Trademark Type

Standard Characters

Goods

Class 10

central venous catheters

Application Number 2,050,960
Language of Application English

Filing Date 2020-09-10

APPLICANT DETAILS

Applicant

Kurtis Moscaluk
23410 TWP rd 570
PO Box 685
Bon Accord
ALBERTA
T0A0K0

TRADEMARK DETAILS

Trademark Type

Design

Visual Representation

dirtyshirt co.

Goods

Class 25

A-shirts; baseball caps and hats; baseball shirts; bomber jackets; button down shirts; casual pants; casual shirts; children's shirts; cloth hats; collared shirts; coveralls; denim jackets; denim pants; denim shirts; dress pants; dress shirts; fishermen's jackets; golf hats; golf pants; golf shirts; heavy jackets; hooded jackets; jackets; jackets and socks; jean jackets; jeans coveralls; jogging pants; knit jackets; knitted shirts; long sleeve shirts; long-sleeved t-shirts; men's shirts; mock turtleneck shirts; muscle shirts; night shirts; open-necked shirts; pique shirts; polo shirts; promotional t-shirts; shirt fronts; shirts; shirts for suits; short pants; short-sleeve shirts; short-sleeved shirts; short-sleeved t-shirts; small hats; snap crotch shirts for infants and toddlers; sport shirts; sports shirts with short sleeves; sweat shirts; sweatshirts; t-shirts; tee-shirts; track pants; women's shirts; work boots; work shoes; work shoes and boots; working overalls

Application Number 2,051,076
Language of Application English

Filing Date 2020-09-10

APPLICANT AND AGENT DETAILS

Applicant

Flora Manufacturing and Distributing Ltd.
7400 Fraser Park Drive
Burnaby
BRITISH COLUMBIA
V5J5B9

Agent

NEXUS LAW GROUP LLP
777 Hornby Street, Suite 2000, Vancouver,
BRITISH COLUMBIA, V6Z1S4

TRADEMARK DETAILS

DAILY ESSENTIALS+

Trademark Type

Standard Characters

Goods

Class 05

dietary supplements for general health and well-being; nutritional supplements for general health and well-being

Application Number 2,051,101
Language of Application English

Filing Date 2020-09-10

APPLICANT AND AGENT DETAILS

Applicant

MEETS TOYS CO., LTD
UNIT G25 WATERFRONT STUDIOS, 1 DOCK
ROAD
London, E16 1AH
UNITED KINGDOM

Agent

YURI CHUMAK
c/o Dickinson Wright LLP, 199 Bay Street,
Suite 2200, Toronto, ONTARIO, M5L1G4

TRADEMARK DETAILS

Trademark Type

Design

Visual Representation



Goods

Class 28

artificial Christmas trees; baby toys; bath toys; candle holders for Christmas trees; dolls; dolls for playing; dolls' clothes; European style dolls; fish hooks; fishing tackle; jigsaw puzzles; pet toys; puppets; stuffed toys; talking dolls; toy animals; toy cars; toy furniture; toy masks; toys for dogs

Application Number 2,051,102
Language of Application English

Filing Date 2020-09-10

APPLICANT AND AGENT DETAILS

Applicant

MEETS TOYS CO., LTD
UNIT G25 WATERFRONT STUDIOS, 1 DOCK
ROAD
London, E16 1AH
UNITED KINGDOM

Agent

YURI CHUMAK
c/o Dickinson Wright LLP, 199 Bay Street,
Suite 2200, Toronto, ONTARIO, M5L1G4

TRADEMARK DETAILS

Trademark Type

Design

Visual Representation



Goods

Class 28

artificial Christmas trees; baby toys; bath toys; candle holders for Christmas trees; dolls; dolls for playing; dolls' clothes; European style dolls; fish hooks; fishing tackle; jigsaw puzzles; pet toys; puppets; stuffed toys; talking dolls; toy animals; toy cars; toy furniture; toy masks; toys for dogs

Application Number 2,051,118
Language of Application English

Filing Date 2020-09-11

APPLICANT AND AGENT DETAILS

Applicant

David Brannen
205-50 Foundry St
Moncton
NEW BRUNSWICK
E1C0J8

Agent

MILTONS IP/P.I.
15 Fitzgerald Rd, Suite 200, Ottawa,
ONTARIO, K2H9G1

TRADEMARK DETAILS

THE STORY ALIGNMENT METHOD

Trademark Type

Standard Characters

Services

Class 45

legal advice; legal consultation services; legal services; legal support services

Application Number 2,051,142
Language of Application English

Filing Date 2020-09-11

APPLICANT DETAILS

Applicant

Roxanna Gumiela
83 Hammond Rd
Mississauga
ONTARIO
L5M2A3

TRADEMARK DETAILS

MESH Yoga

Trademark Type
Standard Characters

Services

Class 41
yoga instruction

Application Number 2,051,155
Language of Application English

Filing Date 2020-09-11

APPLICANT DETAILS

Applicant

Seakura Canada Inc.
2-585 Canarctic Dr
North York
ONTARIO
M3J2P9

TRADEMARK DETAILS

Seakura

Trademark Type

Standard Characters

Goods

Class 31

seaweed for human consumption

Application Number 2,051,178
Language of Application English

Filing Date 2020-09-11

APPLICANT DETAILS

Applicant

AZIO CORPORATION
19933 Harrison Ave
Walnut, CA 91789-2848
UNITED STATES OF AMERICA

TRADEMARK DETAILS

AZIO

Trademark Type

Standard Characters

Goods

Class 09

audio speakers; computer keyboards; computer mouse; computer mouse pads; computer speakers; keyboards for cellular phones; keyboards for computers; keyboards for mobile phones; mouse pads; multifunction computer keyboards; multifunction keyboards; speakers for computers; wireless computer mice; wrist pads; wrist rests; wrist rests for use with computer keyboards; wrist rests for use with computers

Application Number 2,051,189
Language of Application English

Filing Date 2020-09-11

APPLICANT DETAILS

Applicant

ThinkBug LLC
3603 Bridge Walk Dr
Lawrenceville, GA 30044
UNITED STATES OF AMERICA

TRADEMARK DETAILS

Avler

Trademark Type

Standard Characters

Goods

Class 06

steel balls

Application Number 2,051,210
Language of Application English

Filing Date 2020-09-11

APPLICANT DETAILS

Applicant

ThinkBug LLC
3603 Bridge Walk Dr
Lawrenceville, GA 30044
UNITED STATES OF AMERICA

TRADEMARK DETAILS

TOP CHI

Trademark Type

Standard Characters

Goods

Class 28

stress relief exercise balls

Application Number 2,051,297
Language of Application English

Filing Date 2020-09-11

APPLICANT DETAILS

Applicant

Pedram Yazdani
117 Clarendon Dr
Richmond Hill
ONTARIO
L4B3W2

TRADEMARK DETAILS

Trademark Type

Design

Visual Representation



Goods

Class 03

(1) body scrub; body scrubs; facial scrubs; foot scrubs

Class 07

(2) brushes for vacuum cleaners; dust filters and bags for vacuum cleaners; vacuum cleaner attachments; vacuum cleaner bags; vacuum cleaner hoses; vacuum cleaner nozzles; vacuum cleaners; vacuum cleaners for household purposes; vacuum cleaners for industrial purposes

Application Number 2,051,300
Language of Application English

Filing Date 2020-09-11

APPLICANT DETAILS

Applicant
MENGYAO WANG
23 doronthy britton dr
Markham
ONTARIO
L3S3J3

TRADEMARK DETAILS

MyMyLiving

Trademark Type
Standard Characters

Goods

Class 25

(1) ankle socks; baby clothing; business clothing; casual clothing; children's clothing; hats; slipper socks; slippers; socks; socks and stockings

Class 28

(2) dog toys; educational toys; infant toys; inflatable pool toys; pet toys; plastic toys; rubber toys; stuffed toys; talking toys

Application Number 2,051,304
Language of Application English

Filing Date 2020-09-12

APPLICANT DETAILS

Applicant

Christopher Holmes
246 Edgehill Drive
Barrie
ONTARIO
L4N7W9

TRADEMARK DETAILS

FOURTH COAST

Trademark Type

Standard Characters

Goods

Class 25

athletic clothing; baseball caps and hats; beach clothes; belts; casual clothing; children's clothing; cloth hats; outdoor winter clothing; pants; rain coats; rain ponchos; rain suits; shirts; shorts; socks; sport shirts; sweatshirts; swimwear; t-shirts; underwear

Services

Class 35

online sales of clothing; retail sale of clothing

Application Number 2,051,309
Language of Application English

Filing Date 2020-09-12

APPLICANT DETAILS

Applicant

Bosa Global Capital
4405-1011 Cordova St W
1011
Vancouver
BRITISH COLUMBIA
V6C0B2

TRADEMARK DETAILS

Bosa Global Capital Corporation

Trademark Type

Standard Characters

Services

Class 35

acquisition and merger consultation; business acquisition and merger consultation; business consulting in the field of business acquisitions and mergers; business merger consultation

Application Number 2,051,310
Language of Application English

Filing Date 2020-09-12

APPLICANT AND AGENT DETAILS

Applicant

Pitch Black North Ltd.
333 17 Ave SW
212
Calgary
ALBERTA
T2S0A7

Agent

MLT AIKINS LLP
2100 Livingston Place, 222-3rd Avenue SW,
Calgary, ALBERTA, T2P0B4

TRADEMARK DETAILS

Pitch Black North

Trademark Type

Standard Characters

Goods

Class 30

coffee and tea

Application Number 2,051,314
Language of Application English

Filing Date 2020-09-12

APPLICANT DETAILS

Applicant

Paul Brigham
103-3108 Barons Rd
Nanaimo
BRITISH COLUMBIA
V9T4B5

TRADEMARK DETAILS

Trademark Type

Design

Visual Representation



Goods

Class 21

ceramic mugs; coffee cups; mugs

Services

Class 42

clothing design; computer aided graphic design; graphic design

Application Number 2,051,321
Language of Application English

Filing Date 2020-09-12

APPLICANT DETAILS

Applicant

Steven VanMeetelen
53419A RANGE ROAD 154
YELLOWHEAD COUNTY
ALBERTA
T7E3G9

TRADEMARK DETAILS

Cohaja

Trademark Type

Standard Characters

Goods

Class 16

cardboard packaging boxes in collapsible form; containers of cardboard for packaging; gift boxes; industrial packaging containers of paper; packaging boxes of cardboard; packaging boxes of paper; packaging containers of paper; paper bags for packaging; paper wine gift bags; paperboard boxes for industrial packaging

Application Number 2,051,325
Language of Application English

Filing Date 2020-09-13

APPLICANT DETAILS

Applicant

guanghua wang
chenghuaqu shuang lin nan zhi lu 10hao 2lou
8hao
chengdu shi, 610041
CHINA

TRADEMARK DETAILS

APHNUS

Trademark Type

Standard Characters

Goods

Class 25

cycling shoes; deck-shoes; dress shoes; esparto shoes or sandals; field hockey shoes; football shoes; golf shoes; grippers for curling shoes; gymnastic shoes; handball shoes; heel pieces for shoes; infants' shoes; infants' shoes and boots; insoles for shoes and boots; jogging shoes; leather shoes; leisure shoes; mountain bike shoes; mountaineering shoes; riding shoes; rubber shoes

Application Number 2,051,344
Language of Application English

Filing Date 2020-09-14

APPLICANT DETAILS

Applicant

Cong Han
5-38 Fudi Wanliuhui, Changping District
Beijing,
CHINA

TRADEMARK DETAILS

Rhea wigs

Trademark Type

Standard Characters

Goods

Class 26

clown wigs; hair pieces and wigs; wigs

Application Number 2,051,389
Language of Application English

Filing Date 2020-09-14

APPLICANT DETAILS

Applicant

Shenzhen LIKEXIN Technology Co., Ltd
9H-C2, Qiaofu building, News Road 57,
Lianhua Street Meiling community, Futian
Shenzhen, Guangdong, 518000
CHINA

TRADEMARK DETAILS

NKEOSN

Trademark Type

Standard Characters

Goods

Class 09

battery chargers for cell phones; cases adapted for mobile phones; computer hardware; computer networking hardware; connections for electric lines; connectors for electronic circuits; electric cables; electrical plugs; electronic circuits; electronic control systems for automobile brakes; high definition multimedia interface cables; integrated circuit modules; loudspeakers, headphones, microphones and cd players; power switches; tape measures

Application Number 2,051,412
Language of Application English

Filing Date 2020-09-14

APPLICANT DETAILS

Applicant

12271486 Canada Inc.
Mirak Impex Inc
204-8920 Woodbine Ave
Markham
ONTARIO
L3R9W9

TRADEMARK DETAILS

uSafe

Trademark Type

Standard Characters

Goods

Class 09

disposable gloves for laboratory use; dust protective goggles and masks; safety goggles

Application Number 2,051,446
Language of Application English

Filing Date 2020-09-14

APPLICANT DETAILS

Applicant

Jessie Arora
1205-4871 Shell Rd
Richmond
BRITISH COLUMBIA
V6X3Z6

TRADEMARK DETAILS

DF GROUP OF COMPANIES

Trademark Type

Standard Characters

Services

Class 42

architectural consultancy services; architectural services

Application Number 2,051,522
Language of Application English

Filing Date 2020-09-14

APPLICANT DETAILS

Applicant

Foshan Paryoe E-commerce Co., Ltd.
Unit 01, Rm. 22, No. 203, S.1st Blk.
Jingdongyue Rd. Section, leigang St., Foping
2nd Rd.
Jingdongyue Rd. Section, leigang St., Foping
2nd Rd.
Guicheng, Nanhai Dist., Guangdong
Foshan, 528000
CHINA

TRADEMARK DETAILS

Trademark Type

Design

Visual Representation



Goods

Class 08

electric and non-electric depilation appliances; electric beard trimmers; electric hair crimpers; electric hair straighteners; electric irons for styling hair; electric nasal hair trimmers; flat irons; hair clippers; manicure sets; pedicure implements

Application Number 2,051,523
Language of Application English

Filing Date 2020-09-14

APPLICANT DETAILS

Applicant

Cynthia Tsopdieu
13712 165 ave nw
Edmonton
ALBERTA
T6V0G9

TRADEMARK DETAILS

Cbastine

Trademark Type
Standard Characters

Goods

Class 18

handbags, purses and wallets

Application Number 2,051,529
Language of Application English

Filing Date 2020-09-14

APPLICANT DETAILS

Applicant

Shenzhen BeiErSiQi Technology Co.,Ltd.
A204, Block 27, Honghanyuan, Changkeng
West Road
Bantian Street, Longgang District
Shenzhen, 518000
CHINA

TRADEMARK DETAILS

Trademark Type

Design

Visual Representation



Goods

Class 18

all purpose sport bags; back packs; document cases; gym bags; handbags for ladies; handbags for men; hip bags; leather bags; pocketbooks; satchels; schoolbags; sport bags; travel cases; travelling bags

Application Number 2,051,543
Language of Application English

Filing Date 2020-09-15

APPLICANT DETAILS

Applicant

Qiantong Lin
Room 110, No. 532 Pinghu St. Phoenix
Community Neighborhood Committee
Pinghu Street Office, Longgang District
Shenzhen, Guangdong,
CHINA

TRADEMARK DETAILS

WVONMA

Trademark Type

Standard Characters

Goods

Class 16

art pictures; art prints; drawings; graphic art prints; hologram art prints; mounted and unmounted photographs; notebooks; oleographs; paintings; photographs; posters; watercolour finished paintings

Application Number 2,051,549
Language of Application English

Filing Date 2020-09-15

APPLICANT DETAILS

Applicant

Mad Empire Spirits, Inc
6-14845 Yonge St
PM #176
Aurora
ONTARIO
L4G6H8

TRADEMARK DETAILS

UNBUCKLEME

Trademark Type

Standard Characters

Goods

Class 08

hand tools; pincers; pincers being hand tools

Application Number 2,051,560
Language of Application English

Filing Date 2020-09-15

APPLICANT DETAILS

Applicant

Wang Yong
Room 201, Unit 2, Building 9 Yuandahuayuan
mishixiang Street,
Gongshu District, Hangzhou, Zhejiang, 310014
CHINA

TRADEMARK DETAILS

InFei

Trademark Type

Standard Characters

Goods

Class 24

banners of textile or plastic; bed linen; bunting of textile or plastic; coasters of textile; cotton fabrics; face towels of textile; flags of textile or plastic; handkerchiefs of textile; linen for household purposes; place mats of textile; printed calico cloth; table linen of textile; table napkins of textile; table runners of textile; tablemats of textile; textile fabrics; textile tablecloths; towels of textile; unfitted fabric furniture covers; upholstery fabrics

Application Number 2,051,561
Language of Application English

Filing Date 2020-09-15

APPLICANT DETAILS

Applicant

Jinyun County Aopu Lighting Co., Ltd.
3 unit 401, No.41, Jinzhong Rd, Wuyun St,
Jinyun
Lishui, Zhejiang, 321400
CHINA

TRADEMARK DETAILS

Coospider

Trademark Type

Standard Characters

Goods

Class 11

air cleaning units; aquarium lights; ceiling lights; desk lamps; floor lamps; fluorescent lamp tubes; fluorescent lamps; fluorescent lighting fixtures; germicidal lamps for purifying air; halogen lamps; halogen light bulbs; ice-cooling refrigerators for household purposes; infrared lamps; lamp shades; lampshade holders; LED flashlights; spotlights; ultraviolet light (UV) water purification device; UV halogen metal vapour lamps

Claims

Priority Filing Date: July 13, 2020, Country or Office: UNITED KINGDOM, Application No: UK00003511107 in association with the same kind of goods

Application Number 2,051,634
Language of Application English

Filing Date 2020-09-15

APPLICANT DETAILS

Applicant

CSC MARKETING LTD.
PO Box 67052 Rpo Northland Vlg
67052
Calgary
ALBERTA
T2L2L2

TRADEMARK DETAILS

csc strong

Trademark Type

Standard Characters

Goods

Class 20

footrests

Application Number 2,051,706
Language of Application English

Filing Date 2020-09-15

APPLICANT AND AGENT DETAILS

Applicant

Spinrite Inc.
199 Bay Street
Suite 4000
Commerce Court West
Toronto
ONTARIO
M5L1A9

Agent

COZEN O'CONNOR LLP
Bay Adelaide Centre - West Tower, 333 Bay
Street, Suite #1100, Toronto, ONTARIO,
M5H2R2

TRADEMARK DETAILS

O'GO

Trademark Type
Standard Characters

Goods

Class 23
yarn

Application Number 2,051,713
Language of Application English

Filing Date 2020-09-15

APPLICANT DETAILS

Applicant

Orane Anderson
501-2433 Finch Ave W
Toronto
ONTARIO
M9M2E5

TRADEMARK DETAILS

B2B Movers

Trademark Type

Standard Characters

Services

Class 35

(1) business administration in the field of transport and delivery; business management consultancy in the field of transport and delivery

Class 39

(2) moving services

Application Number 2,051,756
Language of Application English

Filing Date 2020-09-16

APPLICANT AND AGENT DETAILS

Applicant

Ning Feng
1403,Duty Free Business Bldg,No. 6
Fuhua One Rd,Futian Dist
Shenzhen City,Guangdong Province,
CHINA

Agent

LEI GAO
18 King Street East, Suite 1400, Toronto,
ONTARIO, M5C1C4

TRADEMARK DETAILS

Trademark Type

Design

Visual Representation



Goods

Class 16

drawing boards; file folders; gummed cloth for stationery purposes; kraft paper; note cards; note paper; office requisites in the form of finger-stalls; paint trays; painters' brushes; paper clips; paper stationery; pens; postcards and greeting cards; staplers; stickers; writing instruments

Application Number 2,051,797
Language of Application English

Filing Date 2020-09-16

APPLICANT DETAILS

Applicant

Heather Leaman
505-1330 15 Ave SW
Calgary
ALBERTA
T3C3N7

TRADEMARK DETAILS

The Tally Bean

Trademark Type
Standard Characters

Services

Class 35
bookkeeping services

Application Number 2,051,805
Language of Application English

Filing Date 2020-09-16

APPLICANT AND AGENT DETAILS

Applicant

Cayman Brands Ltd.
1102 - 323 Wellington Cres
Winnipeg
MANITOBA
R3M0A4

Agent

NADINE D'AGUIAR
Simpson Tower, 401 Bay Street, Suite 2100,
Mailbox #55, Toronto, ONTARIO, M5H2Y4

TRADEMARK DETAILS

CAYMAN BRANDS

Trademark Type

Standard Characters

Goods

Class 03

(1) adhesives for false eyelashes, hair and nails; bar soap; bath oils and bath salts; beauty masks; body scrub; dental rinse; sunscreen

Class 05

(2) antibacterial sprays; nasal rinse

Class 18

(3) all-purpose carrying bags; shoulder bags; sport bags; tote bags

Class 21

(4) cups; drink coasters; drinking bottles for sports; salt and pepper mills; salt and pepper shakers; salt cellars; spice mills; water bottles

Class 24

(5) dish towels for drying; hand towels; kitchen towels of textile; tea towels

Class 25

(6) aprons; caps; hats; sweatshirts; t-shirts

Class 29

(7) flavoured nuts; roasted nuts

Class 30

(8) biscuit mixes; biscuits; cookies; cooking salt; dried herbs for food purposes; salt; savoury and salted biscuits; seasoned salt; spices

Application Number 2,051,808
Language of Application English

Filing Date 2020-09-16

APPLICANT AND AGENT DETAILS

Applicant

Ammar Ali
808-441 Av Du Président-Kennedy
Montréal
QUEBEC
H3A0A4

Agent

SHOIB RABBANI
8585 boulevard Saint-Laurent, suite 230,
Montréal, QUEBEC, H2P2M9

TRADEMARK DETAILS

Leaping Panther

Trademark Type

Standard Characters

Services

Class 35

(1) business management consultancy and advisory services

Class 36

(2) financial analysis and research services; financial planning and investment advisory services; investment management; private equity fund investment services; real estate consultancy; real estate management; venture capital financing; venture capital fund management

Application Number 2,051,817
Language of Application English

Filing Date 2020-09-16

APPLICANT AND AGENT DETAILS

Applicant

Sailun Group Co., Ltd.
No. 588, Maoshan Road
Huangdao District, Qingdao
Shandong,
CHINA

Agent

MILLER THOMSON LLP
SCOTIA PLAZA, 40 KING STREET WEST,
SUITE 5800, P.O. BOX 1011, TORONTO,
ONTARIO, M5H3S1

TRADEMARK DETAILS

AGILITY

Trademark Type
Standard Characters

Goods

Class 12

tires

Application Number 2,051,819
Language of Application English

Filing Date 2020-09-16

APPLICANT AND AGENT DETAILS

Applicant

Willow Personal Development and End of Life
Education Enterprises
404-1855 Nelson St
Vancouver
BRITISH COLUMBIA
V6G1M9

Agent

HOFFER ADLER LLP
1102-595 Bay Street, Toronto, ONTARIO,
M5G2C2

TRADEMARK DETAILS

A Willow Workshop

Trademark Type

Standard Characters

Services

Class 41

(1) workshops and seminars in the field of will and estate planning

Class 45

(2) providing on-line information in the field of spirituality, self-help, and personal empowerment subject matters

Application Number 2,051,948
International Registration Number 1550186
Language of Application English

Filing Date 2020-03-10

APPLICANT AND AGENT DETAILS

Applicant

EMMI DESSERT ITALIA S.P.A.
Via Vittor Pisani 20
I-20124 MILANO
ITALY

Agent

ROBIC
630, boul. René-Lévesque Ouest, 20e étage,
Montréal, QUEBEC, H3B1S6

TRADEMARK DETAILS

Trademark Type

Design

Visual Representation



Foreign Character Translation

As provided by the applicant, the translation of the foreign words in the trademark is "DIVINE GOODNESS DELICIOUS CREATIONS".

Goods

Class 29

(1) Almond milk-based beverages; apple purée; preserved berries; beverages made from yogurt; bottled fruits; candied fruit snacks; Chantilly cream; coconut milk-based beverages; compotes; dairy cream; curd; dried fruit mixes; eggs, milk and milk products; frozen fruits; fruit purées; fruit salads; fruits, tinned; hazelnut spreads; jellies, jams, compotes; marmalade; mascarpone; milk and milk products; milk-based beverages containing coffee; milk-based beverages containing fruit juice; milk-based beverages containing fruits; milk-based beverages flavored with chocolate; nut-based spreads; white pudding; whipping cream; whipped cream; yogurt; panna cotta.

Class 30

(2) Almond paste; almond confectionery; brownies; bulgur, cake dough, cakes; caramels [sweets]; cheesecakes; chocolate; chocolate-based beverages; chocolate-based spreads; chocolate-based beverages with milk; chocolate desserts; chocolate mousses; cocoa-based beverages; coffee-based beverages; crème brûlée; crème caramels; dessert mousses [confectionery]; filled chocolates; frozen yogurt [confectionery ices]; ice cream; rice pudding; sorbets [ices]; sugar.

Claims

Priority Filing Date: February 28, 2020, Country or Office: ITALY, Application No:
302020000020731 in association with the same kind of goods

Application Number 2,052,055
International Registration Number 1551100
Language of Application English

Filing Date 2020-06-30

APPLICANT AND AGENT DETAILS

Applicant

INTERACTIVE MEDIA S.P.A.
Viale Città d'Europa 679
I-00144 Roma
ITALY

Agent

ROBIC
630, boul. René-Lévesque Ouest, 20e étage,
Montréal, QUEBEC, H3B1S6

TRADEMARK DETAILS

Trademark Type

Design

Visual Representation



Colour Claim

Colour is claimed as a feature of the trademark. The top circular design is in the colour blue. The bottom circular design is in the colour red. The overlap portion of the design is in the colour purple. The wording is in the colour black.

Goods

Class 09

Downloadable and recorded computer software platforms for database management; video conference software; computer telephony software; instant messaging software; gesture recognition software; speech recognition software; facial recognition software; facial analysis software; speech analytics software; database management software; downloadable and recorded image management software for organizing and viewing digital images and photographs; computer chatbot software for simulating conversations; virtual and augmented reality computer game software; computer software for interpreting fingerprints or palm prints; computer software for database management; intelligent character recognition [ICR] software; real-time collaborative editing [RTCE] platforms [software]; personal computer application software for document control systems; customer relation management [CRM] software; downloadable and recorded digital dashboard software for creating dashboards to view business data; artificial intelligence and machine learning software used in computer speech analysis programs; computer software to enable teleconferencing, videoconferencing and videophone services; computer software for audibly controlling a computer and the operation thereof; computer software for biometric systems for the identification and authentication of persons; downloadable and recorded software for processing images, graphics, audio, video and text; software for the planning, integration and optimisation of smart city applications; data and file management and database software; software for converting natural language into machine executable commands; software for the integration of

artificial intelligence and machine learning in the field of big data; artificial intelligence software for analysis of speech recognition; speech recognition software; biometric voice recognition systems; voice processing systems, namely voice recognition software, digital voice recorders and signal processors; speech processing equipment, namely speech analytics and recognition software, digital voice recorders and signal processors; downloadable and recorded authentication software for authenticating identity of users; electronic telephone exchanges; cloud servers; audio processing apparatus, namely audio analyzers, audio mixers and audio receivers; interface boards and cards for computers; computer programs for user interface design.

Services

Class 38

(1) Providing Internet chatrooms; providing Internet chatrooms; providing on-line chat rooms for social networking; voice mail services; telephone voice messaging services; providing voice chat services; voice over Internet protocol [VoIP] communication services; wireless PBX services; PBX dialing services; leasing of telephone circuits; provision of telecommunications connections to telephone chat lines; information, consultancy and advisory services relating to telecommunications, namely telephone voice messaging services, voice chat services and on-line chat rooms services; interactive telecommunications services, namely audio teleconferencing services, video conferencing services, teleconferencing services and web conferencing services; providing third party users with access to telecommunication infrastructure, namely telephone voice messaging services, voice chat services and on-line chat rooms services; provision of communications facilities for electronic interchange of electronic data, namely audio, video and voice data via telephone voice messaging services, voice chat services and on-line chat rooms services; operating of electronic communications systems, namely telephone voice messaging services, voice chat services and on-line chat rooms services; rental of communications systems, namely telephones, video conferencing equipment and modems.

Class 42

(2) Advisory services relating to man-machine interfaces for computer software; IT consultancy, advisory and information services, namely computer software technical support services and troubleshooting in the nature of diagnosing computer hardware and software problems; advisory and information services relating to the design and development of computer peripherals; remote server administration; computer system analysis; computer network configuration, hosting and rental of software; support and maintenance services for computer software; platform as a service [PaaS] provider featuring computer software platforms to develop software via a website; creation of cloud computing platforms for third parties; preparation of computer programs for data processing; software development, programming and implementation; software development; rental of software; computer software design; maintenance of software; programming of telecommunications software; custom design of software packages; software design and development; software as a service [SaaS] provider featuring online non-downloadable software for machine learning; testing of computer software; development of computer hardware and software; development of word processing software; feasibility study services relating to computer software; creation of computer programmes for data processing; design of software for embedded devices; design and development of virtual reality software; design of software for audio and video operators; advisory services relating to computer software design; computer programming of electronic data processing (EDP) software; programming of software for Internet portals, chatrooms, chat lines and Internet forums; development of software for automated business process discovery (ABPD); consultancy and information services relating to the design, programming and maintenance of computer software; computer services for the analysis of data,

namely computer security threat analysis for protecting data; software as a service [SaaS] using artificial intelligence, featuring online non-downloadable software programs for developing artificial intelligence technology for machine learning, deep learning and deep neural networks; cloud computing providing software for database management; providing virtual computer environments through cloud computing.

Claims

Priority Filing Date: May 18, 2020, Country or Office: EUIPO (EU), Application No: 018241524 in association with the same kind of goods and in association with the same kind of services

Application Number 2,052,056
International Registration Number 1551192
Language of Application English

Filing Date 2020-06-30

APPLICANT AND AGENT DETAILS

Applicant

INTERACTIVE MEDIA S.P.A.
Viale Città d'Europa 679
I-00144 Roma
ITALY

Agent

ROBIC
630, boul. René-Lévesque Ouest, 20e étage,
Montréal, QUEBEC, H3B1S6

TRADEMARK DETAILS

Trademark Type

Design

Visual Representation



Goods

Class 09

Downloadable and recorded computer software platforms for database management; video conference software; computer telephony software; instant messaging software; gesture recognition software; speech recognition software; facial recognition software; facial analysis software; speech analytics software; database management software; downloadable and recorded image management software for organizing and viewing digital images and photographs; computer chatbot software for simulating conversations; virtual and augmented reality computer game software; computer software for interpreting fingerprints or palm prints; computer software for database management; intelligent character recognition [ICR] software; real-time collaborative editing [RTCE] platforms [software]; personal computer application software for document control systems; customer relation management [CRM] software; downloadable and recorded digital dashboard software for creating dashboards to view business data; artificial intelligence and machine learning software used in computer speech analysis programs; computer software to enable teleconferencing, videoconferencing and videophone services; computer software for audibly controlling a computer and the operation thereof; computer software for biometric systems for the identification and authentication of persons; downloadable and recorded software for processing images, graphics, audio, video and text; software for the planning, integration and optimisation of smart city applications; data and file management and database software; software for converting natural language into machine executable commands; software for the integration of artificial intelligence and machine learning in the field of big data; artificial intelligence software for analysis of speech recognition; speech recognition software; biometric voice recognition systems; voice processing systems, namely voice recognition software, digital voice recorders and signal processors; speech processing equipment, namely speech analytics and recognition software, digital voice recorders and signal processors; downloadable and recorded authentication software for authenticating identity of users; electronic telephone exchanges; cloud servers; audio

processing apparatus, namely audio analyzers, audio mixers and audio receivers; interface boards and cards for computers; computer programs for user interface design.

Services

Class 38

(1) Providing Internet chatrooms; providing Internet chatrooms; providing on-line chat rooms for social networking; voice mail services; telephone voice messaging services; providing voice chat services; voice over Internet protocol [VoIP] communication services; wireless PBX services; PBX dialing services; leasing of telephone circuits; provision of telecommunications connections to telephone chat lines; information, consultancy and advisory services relating to telecommunications, namely telephone voice messaging services, voice chat services and on-line chat rooms services; interactive telecommunications services, namely audio teleconferencing services, video conferencing services, teleconferencing services and web conferencing services; providing third party users with access to telecommunication infrastructure, namely telephone voice messaging services, voice chat services and on-line chat rooms services; provision of communications facilities for electronic interchange of electronic data, namely audio, video and voice data via telephone voice messaging services, voice chat services and on-line chat rooms services; operating of electronic communications systems, namely telephone voice messaging services, voice chat services and on-line chat rooms services; rental of communications systems, namely telephones, video conferencing equipment and modems.

Class 42

(2) Advisory services relating to man-machine interfaces for computer software; IT consultancy, advisory and information services, namely computer software technical support services and troubleshooting in the nature of diagnosing computer hardware and software problems; advisory and information services relating to the design and development of computer peripherals; remote server administration; computer system analysis; computer network configuration, hosting and rental of software; support and maintenance services for computer software; platform as a service [PaaS] provider featuring computer software platforms to develop software via a website; creation of cloud computing platforms for third parties; preparation of computer programs for data processing; software development, programming and implementation; software development; rental of software; computer software design; maintenance of software; programming of telecommunications software; custom design of software packages; software design and development; software as a service [SaaS] provider featuring online non-downloadable software for machine learning]; testing of computer software; development of computer hardware and software; development of word processing software; feasibility study services relating to computer software; creation of computer programmes for data processing; design of software for embedded devices; design and development of virtual reality software; design of software for audio and video operators; advisory services relating to computer software design; computer programming of electronic data processing (EDP) software; programming of software for Internet portals, chatrooms, chat lines and Internet forums; development of software for automated business process discovery (ABPD); consultancy and information services relating to the design, programming and maintenance of computer software; computer services for the analysis of data, namely computer security threat analysis for protecting data; software as a service [SaaS] using artificial intelligence, featuring online non-downloadable software programs for developing artificial intelligence technology for machine learning, deep learning and deep neural networks; cloud computing providing software for database management; providing virtual computer environments through cloud computing.

Claims

Priority Filing Date: May 18, 2020, Country or Office: EUIPO (EU), Application No: 018241501 in association with the same kind of goods and in association with the same kind of services

Application Number 2,052,353
Language of Application French

Filing Date 2020-09-16

APPLICANT DETAILS

Applicant

Émilie Martel
1161 Rue De La Rocade
Saint-Dominique
QUÉBEC
J0H1L0

TRADEMARK DETAILS

in the woods

Trademark Type

Standard Characters

Goods

Class 03

cosmetic concealers; cosmetics; decorative cosmetics; cosmetics and make-up; cosmetics and make-up; cosmetics for use on the skin; beauty care cosmetics; body and beauty care cosmetics; eyebrow cosmetics; cosmetics in the form of lotions; eyebrow cosmetics; decorative cosmetics; cosmetics for personal use; cosmetics in the form of milks, lotions and emulsions; anti-aging creams for cosmetic purposes; creams for cellulite reduction for cosmetic purposes; anti-wrinkle creams for cosmetic purposes; after-sun creams for cosmetic purposes; cosmetic creams; cosmetic body creams; cosmetic massage creams; sun creams for cosmetic purposes; hair care creams for cosmetic purposes; cosmetic cleansing creams; exfoliant creams for cosmetic purposes; cosmetic cleansing creams; age spot reducing creams for cosmetic purposes; skin creams for cosmetic purposes; body creams for cosmetic purposes; face and body creams for cosmetic purposes; face creams for cosmetic use; lip creams for cosmetic purposes; cosmetic hand creams; nail creams for cosmetic purposes; eye creams for cosmetic purposes; cosmetic creams for firming skin around eyes; skin conditioning creams for cosmetic purposes; sunscreen creams for cosmetic purposes; cosmetic body scrubs; colognes, perfumes and cosmetics; aloe vera gel for cosmetic purposes; age retardant gels for cosmetic purposes; after-sun gels for cosmetic purposes; cosmetic creams and gels for the face, hands and body; eye gels for cosmetic purposes; hemp oil for cosmetic purposes; hemp seed oil for cosmetic purposes; lavender oil for cosmetic use; rose oil for cosmetic purposes; after-sun oils for cosmetic purposes; suntan oils for cosmetic purposes; body oils for cosmetic purposes; cosmetic oils; cosmetic oils for the epidermis; cosmetic oils for the epidermis; bath oils for cosmetic purposes; cosmetic bath oils; essential oils for cosmetic purposes; suntan oils for cosmetic purposes; oils for cosmetic purposes; cosmetic tanning and after-sun milks, gels and oils; facial moisturizers; cosmetic towelettes; pre-moistened cosmetic wipes; tissues impregnated with cosmetic lotions; age retardant lotions for cosmetic purposes; sunscreen lotions for cosmetic purposes; after-sun lotions for cosmetic purposes; cosmetic hair lotions; lotions for cellulite reduction for cosmetic purposes; cosmetic suntan lotions; cosmetic skin fresheners; sun block lotions for cosmetic purposes; sun care lotions for cosmetic purposes; hair care lotions for cosmetic purposes; cosmetic creams and lotions; cosmetic creams and lotions for face and body care; cosmetic skin lotions; bath lotions for cosmetic purposes; body

lotions for cosmetic purposes; face and body lotions for cosmetic purposes; cosmetic facial lotions; hand lotions for cosmetic purposes; cosmetic skin care lotions; lotions for face and body care for cosmetic purposes; eye lotions for cosmetic purposes; lotions for cosmetic purposes; cosmetic lotions for reducing the appearance of age spots and freckles; cosmetic powders, creams and lotions for the face, hands and body; cosmetic kits; gift baskets containing cosmetics; hair pomades for cosmetic purposes; stick pomades for cosmetic purposes; pomades for cosmetic purposes; body powders for cosmetic purposes; cosmetic face powders; face powder for cosmetic purposes; cosmetic creams, milks, lotions, gels and powders for the face, hands and body; cosmetic soaps; sunscreen for cosmetic purposes

Services**Class 35**

online sales of cosmetics

Application Number 2,052,356
Language of Application English

Filing Date 2020-09-16

APPLICANT AND AGENT DETAILS

Applicant

MEETS TOYS CO., LTD
UNIT G25 WATERFRONT STUDIOS, 1 DOCK
ROAD
LONDON, E16 1AH
UNITED KINGDOM

Agent

YURI CHUMAK
c/o Dickinson Wright LLP, 199 Bay Street,
Suite 2200, Toronto, ONTARIO, M5L1G4

TRADEMARK DETAILS

Trademark Type

Design

Visual Representation



HDSCUKK

Goods

Class 28

artificial Christmas trees; baby toys; bath toys; candle holders for Christmas trees; dolls; dolls for playing; dolls' clothes; European style dolls; fish hooks; fishing tackle; jigsaw puzzles; pet toys; puppets; stuffed toys; talking dolls; toy animals; toy cars; toy furniture; toy masks; toys for dogs

Application Number 2,052,362
Language of Application English

Filing Date 2020-09-16

APPLICANT AND AGENT DETAILS

Applicant

MEETS TOYS CO., LTD
UNIT G25 WATERFRONT STUDIOS, 1 DOCK
ROAD
LONDON, E16 1AH
UNITED KINGDOM

Agent

YURI CHUMAK
c/o Dickinson Wright LLP, 199 Bay Street,
Suite 2200, Toronto, ONTARIO, M5L1G4

TRADEMARK DETAILS

Trademark Type

Design

Visual Representation



Goods

Class 28

artificial Christmas trees; baby toys; bath toys; candle holders for Christmas trees; dolls; dolls for playing; dolls' clothes; European style dolls; fish hooks; fishing tackle; jigsaw puzzles; pet toys; puppets; stuffed toys; talking dolls; toy animals; toy cars; toy furniture; toy masks; toys for dogs

Application Number 2,052,378
Language of Application English

Filing Date 2020-09-17

APPLICANT DETAILS

Applicant

Scott Hager
29 Springfield Dr
Brantford
ONTARIO
N3R1N4

TRADEMARK DETAILS

Axe...and You Shall Receive

Trademark Type

Standard Characters

Goods

Class 09

(1) amplifiers for bass guitars; amplifiers for guitars; guitar amplifiers; guitar effects processors

Class 15

(2) acoustic guitars; electric basses; electric guitars; guitar pedals; guitars

Application Number 2,052,381
Language of Application English

Filing Date 2020-09-17

APPLICANT DETAILS

Applicant

Agile Sustainability Management Inc.
1842 West 14th Ave
Vancouver
BRITISH COLUMBIA
V6J2J9

TRADEMARK DETAILS

MAKING METALS WORK FOR US ALL

Trademark Type

Standard Characters

Goods

Class 14

badges of precious metal; bracelets; coins; figures of precious metal; gold; gold alloy ingots; gold and its alloys; gold bullion; gold ingots; jewellery; jewellery bracelets; jewellery brooches; jewellery plated with precious metals; jewelry; jewelry rings; lapel badges of precious metal; medallions; medals; metal jewellery; model figures ornaments of precious metal; precious metals; precious metals and alloys thereof; processed precious metals; silver; silver bullion; silver ingots; silver jewelry; statues of precious metals; unworked gold

Services

Class 35

advertising services for promoting public awareness of environmental issues and initiatives; business management planning; business planning; business risk assessment services; business risk management services; business strategic planning; business strategy development services; consultancy and advisory services in the field of business strategy; corporate identity services; corporate image development consultation; public relations; public relations consultancy; public relations services

Application Number 2,052,390
Language of Application English

Filing Date 2020-09-17

APPLICANT DETAILS

Applicant
MISSION HILL FOODS CO. LTD.
1529 Vineyard Dr
West Kelowna
BRITISH COLUMBIA
V4T2Y7

TRADEMARK DETAILS

ATU 9000

Trademark Type
Standard Characters

Goods

Class 30

candy; coffee; fruit jelly candy; tea; tea extracts; wild rice; yeast; yeast extracts; yeast powder

Application Number 2,052,391
Language of Application English

Filing Date 2020-09-17

APPLICANT AND AGENT DETAILS

Applicant

JIEHUA ELECTRONIC COMMERCE LIMITED
Room 702 Kowloon Building
555 Nathan Road
Kowloon
HONG KONG, 999077
HONG KONG

Agent

MILTONS IP/P.I.
15 Fitzgerald Rd, Suite 200, Ottawa,
ONTARIO, K2H9G1

TRADEMARK DETAILS

smartake

Trademark Type

Standard Characters

Goods

Class 21

baking mats; coffee services; comb cases; feather-dusters; food storage containers; garlic presses; hair for brushes; ice buckets; large-toothed combs for the hair; lunch boxes; non-electric waffle irons; nozzles for sprinkler hose; pouring spouts; shower caddies; soap holders; spatulas for kitchen use; sponge holders; toilet paper holders; towel rails and rings; vacuum bottles

Application Number 2,052,392
Language of Application English

Filing Date 2020-09-17

APPLICANT AND AGENT DETAILS

Applicant

KAILI COMMERCE TECHNOLOGY
(CANADA) LTD.
55 Administration Road Unit 12
Vaughan
ONTARIO
L4K4G9

Agent

YURI CHUMAK
c/o Dickinson Wright LLP, 199 Bay Street,
Suite 2200, Toronto, ONTARIO, M5L1G4

TRADEMARK DETAILS

Trademark Type

Design

Visual Representation

Paxdon

Goods

Class 06

aluminium; balustrades of metal; brackets of metal for furniture; building panels of metal; cabanas of metal; casement windows of metal; door frames of metal; doors of metal; fences of metal; folding doors of metal; frames of metal for sliding doors; gratings of metal; metal fittings for windows; metal trellises; metal window fittings; metal windows; palings of metal; poles of metal; pre-fabricated houses of metal; staircases of metal

Application Number 2,052,393
Language of Application English

Filing Date 2020-09-17

APPLICANT AND AGENT DETAILS

Applicant

Shenzhen Mingrui E-Commerce Co.,Ltd
Room 203, Building 6, Yungu 2nd Phase
Taoyuan Street, Nanshan District
Shenzhen, Guangdong, 518000
CHINA

Agent

MILTONS IP/P.I.
15 Fitzgerald Rd, Suite 200, Ottawa,
ONTARIO, K2H9G1

TRADEMARK DETAILS

JARLINK

Trademark Type

Standard Characters

Goods

Class 16

adhesive tape dispensers; almanacs; compasses for drawing; drawing pens; geographical maps; paintbrushes; paper bags for packaging; paper hole punches; paper shredders for office use; parchment paper; pen cases; pen holders; pencil sharpeners; pencils; photograph stands; rubber erasers; stickers; writing or drawing books

Application Number 2,052,466
Language of Application English

Filing Date 2020-09-17

APPLICANT DETAILS

Applicant

Christopher Valencia
38 Joe Shuster Way
Toronto
ONTARIO
M6k0a5

TRADEMARK DETAILS

Elevated Sport Nutrition

Trademark Type

Standard Characters

Goods

Class 05

nutritional supplements for general health and well-being

Application Number 2,052,467
Language of Application English

Filing Date 2020-09-17

APPLICANT DETAILS

Applicant

MSL
161 rue St-Paul
P.O. Box C.P.38
Louiseville
QUEBEC
J5V2L6

TRADEMARK DETAILS

SONOcrete

Trademark Type

Standard Characters

Goods

Class 17

(1) acoustical insulation; felt insulation

Class 19

(2) fiberboards

Application Number 2,052,468
Language of Application English

Filing Date 2020-09-17

APPLICANT DETAILS

Applicant

MSL
161 rue St-Paul
P.O. Box C.P.38
Louiseville
QUEBEC
J5V2L6

TRADEMARK DETAILS

SOUNDcrete

Trademark Type

Standard Characters

Goods

Class 17

(1) acoustical insulation; felt insulation

Class 19

(2) fiberboards

Application Number 2,052,470
Language of Application English

Filing Date 2020-09-17

APPLICANT DETAILS

Applicant

Furqan Shoaib
6252 Lisgar Drive
Mississauga
ONTARIO
L5N7V2

TRADEMARK DETAILS

Metgear

Trademark Type
Standard Characters

Goods

Class 20
computer furniture

Application Number 2,052,540
Language of Application English

Filing Date 2020-09-17

APPLICANT DETAILS

Applicant

C.G. Management & COmmunications
(conducting business as The CG Group)
175 Commerce Valley Drive West
Suite 220
Markham
ONTARIO
L3T7P6

TRADEMARK DETAILS

MAKING EVERY SECOND COUNT

Trademark Type

Standard Characters

Services

Class 35

(1) advertising agencies; advertising agency services; advertising and business management consultancy; advertising by transmission of on-line publicity for third parties through electronic communications networks; advertising copywriting; advertising flyer distribution; advertising flyer distribution for others; advertising on the Internet for others; advertising services for promoting public awareness of environmental issues and initiatives; advertising services for promoting public awareness of the benefits of physical activity; advertising the goods and services of others

Class 43

(2) housing services for seniors; providing temporary housing accommodations for seniors; retirement home services; retirement homes

Class 44

(3) convalescence homes; convalescent home services; convalescent homes; geriatric nursing services; home nursing aid services; home-visit nursing care; nursing home services; nursing homes; providing information relating to nursing care services; rest home services; rest homes

Application Number 2,052,541
Language of Application English

Filing Date 2020-09-17

APPLICANT DETAILS

Applicant

C.G. Management & COmmunications
(conducting business as The CG Group)
175 Commerce Valley Drive West
Suite 220
Markham
ONTARIO
L3T7P6

TRADEMARK DETAILS

LIVING THE SECOND DREAM

Trademark Type

Standard Characters

Services

Class 35

(1) advertising agencies; advertising agency services; advertising and business management consultancy; advertising by transmission of on-line publicity for third parties through electronic communications networks; advertising copywriting; advertising flyer distribution; advertising of commercial real estate for others; advertising of residential real estate for others; advertising on the Internet for others

Class 43

(2) housing services for seniors; providing temporary housing accommodations for seniors; retirement home services; retirement homes

Class 44

(3) convalescence homes; convalescent home services; convalescent homes; home nursing aid services; home-visit nursing care; nursing home services; nursing homes; rest home services; rest homes

Application Number 2,052,553
Language of Application English

Filing Date 2020-09-17

APPLICANT DETAILS

Applicant

Trihard, Inc
1013 Centre Rd Ste 403
Wilmington, DE 19805
UNITED STATES OF AMERICA

TRADEMARK DETAILS

TRIHARD

Trademark Type

Standard Characters

Goods

Class 03

after-shave balms; anti-perspirants and deodorants for personal use; bar soap; bath and shower gels; bath bombs; bath cream; bath crystals; beauty balm creams; body and beauty care cosmetics; body lotions; cosmetic creams and lotions; hair conditioners; hair shampoo; lip balm; shaving balm; sunscreen

Application Number 2,052,614
Language of Application English

Filing Date 2020-09-18

APPLICANT AND AGENT DETAILS

Applicant

Shenzhen Haowei Technology Co., Ltd
Room A2212, Rongde International Yuxin
Apartment
Henggang Street, Longgang District
Shenzhen, 518000
CHINA

Agent

MILTONS IP/P.I.
15 Fitzgerald Rd, Suite 200, Ottawa,
ONTARIO, K2H9G1

TRADEMARK DETAILS

TOOLSUPP

Trademark Type

Standard Characters

Goods

Class 09

baby monitors; camcorders; cameras; car video recorders; closed circuit television cameras; computer monitors; computer stands; liquid crystal display monitors; motion-activated cameras; rearview cameras for vehicles; security and fire alarms; thermal imaging cameras; touchscreen monitors; video camera stands; video monitors; wearable video display monitors

Application Number 2,052,669
Language of Application English

Filing Date 2020-09-18

APPLICANT DETAILS

Applicant

Petro Buster Inc.
1400 Penetanguishene Rd
Springwater
ONTARIO
L9X1Z3

TRADEMARK DETAILS

Petro Buster

Trademark Type

Standard Characters

Goods

Class 01

(1) petroleum dispersants

Class 03

(2) degreasing preparations for concrete

Services

Class 42

technical consultancy in the field of environmental science

Application Number 2,052,671
Language of Application English

Filing Date 2020-09-18

APPLICANT AND AGENT DETAILS

Applicant

Dynem Inc.
21 Overlea Boulevard
Toronto
ONTARIO
M4H1P2

Agent

ANITA MAR
dba Trademark Angel , Suite 521, 6-2557
Dougall Avenue, Windsor, ONTARIO, N8X1T5

TRADEMARK DETAILS

DYNEM

Trademark Type

Standard Characters

Goods

Class 25

caps; hooded pullovers; hooded sweatshirts; hooded tops; jogging pants; leg warmers; long-sleeved t-shirts; men's underwear; running shorts; shoes; short-sleeved t-shirts; shorts; skull caps; socks; sports bras; sports clothing; sportswear; t-shirts; tank tops; track suits; underwear; women's sportswear; women's underwear; yoga pants

Application Number 2,052,672
Language of Application English

Filing Date 2020-09-18

APPLICANT AND AGENT DETAILS

Applicant

Dynem Inc.
21 Overlea Boulevard
Toronto
ONTARIO
M4H1P2

Agent

ANITA MAR
dba Trademark Angel , Suite 521, 6-2557
Dougall Avenue, Windsor, ONTARIO, N8X1T5

TRADEMARK DETAILS

BE THE POWERHOUSE

Trademark Type

Standard Characters

Goods

Class 25

caps; hooded pullovers; hooded sweatshirts; hooded tops; jogging pants; leg warmers; long-sleeved t-shirts; men's underwear; running shorts; shoes; short-sleeved t-shirts; shorts; skull caps; socks; sports bras; sports clothing; sportswear; t-shirts; tank tops; track suits; underwear; women's sportswear; women's underwear; yoga pants

Application Number 2,052,702
Language of Application English

Filing Date 2020-09-18

APPLICANT AND AGENT DETAILS

Applicant

Willow Personal Development and End of Life
Education Enterprises
404-1855 Nelson St
Vancouver
BRITISH COLUMBIA
V6G1M9

Agent

HOFFER ADLER LLP
1102-595 Bay Street, Toronto, ONTARIO,
M5G2C2

TRADEMARK DETAILS

Willow EOL Educator

Trademark Type

Standard Characters

Services

Class 41

(1) workshops and seminars in the field of will and estate planning

Class 45

(2) providing on-line information in the field of spirituality, self-help, and personal empowerment subject matters

Application Number 2,052,705
Language of Application English

Filing Date 2020-09-18

APPLICANT DETAILS

Applicant

CHRCH Fitness Inc.
2-107 1st St W
North Vancouver
BRITISH COLUMBIA
V7M1B1

TRADEMARK DETAILS

Trademark Type

Design

Visual Representation

CHRCH

Services

Class 38

(1) providing streaming audio and video such as music, movies, television shows, music videos, news and sports webcasts via a website; streaming of audio and video via the Internet featuring music, movies, news, and sports

Class 41

(2) conducting fitness classes; developing fitness programs; fitness training; personal fitness training services; providing information in the field of exercise via an interactive website

Application Number 2,052,728
Language of Application English

Filing Date 2020-09-18

APPLICANT DETAILS

Applicant

4 Excellence
#404 1505 8th Ave NW
Calgary
ALBERTA
T2N4N7

TRADEMARK DETAILS

Make Shift Happen

Trademark Type

Standard Characters

Services

Class 35

business management consultancy as well as development of processes for the analysis and the implementation of strategy plans and management projects

Application Number 2,052,756
Language of Application English

Filing Date 2020-09-18

APPLICANT DETAILS

Applicant
ELN LIVING LTD.
3rd Floor - 422 Richards Street
Vancouver
BRITISH COLUMBIA
V6B2Z4

TRADEMARK DETAILS

Avagne

Trademark Type
Standard Characters

Goods

Class 20

(1) mattress toppers; pillows

Class 24

(2) comforters; duvets; pillow protectors

Application Number 2,052,774
Language of Application English

Filing Date 2020-09-18

APPLICANT DETAILS

Applicant

Dustin Loxterkamp
1163 West Fraser Rd
Quesnel
BRITISH COLUMBIA
V2J6G7

TRADEMARK DETAILS

ORBIS CHURCH

Trademark Type

Standard Characters

Services

Class 45

evangelistic ministerial services

Application Number 2,052,781
Language of Application English

Filing Date 2020-09-18

APPLICANT DETAILS

Applicant

Magnus Greaves
739 East 24th Avenue
Vancouver
BRITISH COLUMBIA
V5V2A6

TRADEMARK DETAILS

RACEWKND

Trademark Type
Standard Characters

Goods

Class 16

(1) magazines

Class 25

(2) casual clothing

Application Number 2,052,784
Language of Application English

Filing Date 2020-09-18

APPLICANT DETAILS

Applicant

ELN LIVING LTD.
3rd Floor - 422 Richards Street
Vancouver
BRITISH COLUMBIA
V6B2Z4

TRADEMARK DETAILS

Intuitive Fibre

Trademark Type

Standard Characters

Goods

Class 20

(1) mattress toppers; pillows

Class 22

(2) pillow fillings

Class 24

(3) comforters; duvets; pillow protectors

Application Number 2,052,785
Language of Application English

Filing Date 2020-09-18

APPLICANT DETAILS

Applicant

ELN LIVING LTD.
3rd Floor - 422 Richards Street
Vancouver
BRITISH COLUMBIA
V6B2Z4

TRADEMARK DETAILS

Refresh Fibre

Trademark Type

Standard Characters

Goods

Class 20

(1) mattress toppers; pillows

Class 22

(2) pillow fillings

Class 24

(3) comforters; duvets; pillow protectors

Application Number 2,052,803
Language of Application English

Filing Date 2020-09-18

APPLICANT DETAILS

Applicant

Jun feng Fu
Dongmen Industrial Area, Fengzhou Town,
No.902, Unit D, Building A, Huida Huayuan
362333
Quanzhou, 362333
CHINA

TRADEMARK DETAILS

Entchin

Trademark Type

Standard Characters

Goods

Class 18

back packs; fanny packs

Application Number 2,052,821
Language of Application English

Filing Date 2020-09-19

APPLICANT AND AGENT DETAILS

Applicant

IFRONT INDUSTRIES LIMITED
RM 2107, 21/F C C WU BLDG
302-308 HENNESSY RD
WANCHAI HK,
HONG KONG

Agent

MILTONS IP/P.I.
15 Fitzgerald Rd, Suite 200, Ottawa,
ONTARIO, K2H9G1

TRADEMARK DETAILS

YOOKAI

Trademark Type

Standard Characters

Goods

Class 07

agricultural cultivators; carburetors; chain saws; earth augers; electricity generators; engine cylinders; gas filters for engines; gaskets for engines; lawnmowers; marine engines and parts and fittings thereof; oil filters for engines; power operated hedge trimmers; snow blowers; starters for motors and engines; stators for machines

Application Number 2,052,838
Language of Application English

Filing Date 2020-09-21

APPLICANT DETAILS

Applicant

Xinze Chen
205, Bldg. 3, Zone 4, Buxin Garden, No. 1069,
Taibai Rd., Luohu Dist.
Shenzhen, Guangdong,
CHINA

TRADEMARK DETAILS

Coalreti

Trademark Type

Standard Characters

Goods

Class 03

abrasives for re-surfacing materials before painting; aromatic essential oils; breath freshening sprays; cosmetic pencils; cosmetics; facial beauty masks; facial cleansers; false eyelashes; fragrances; hair shampoo; hair tonics; laundry stain removers; lipsticks; nail lacquer; perfumes; skin care creams; soaps for household use; sunscreen; toothpaste; vaginal washes for personal sanitary or deodorant purposes

Application Number 2,052,840
Language of Application English

Filing Date 2020-09-21

APPLICANT DETAILS

Applicant

Xinze Chen
205, Bldg. 3, Zone 4, Buxin Garden, No. 1069,
Taibai Rd., Luohu Dist.
Shenzhen ,Guangdong,
CHINA

TRADEMARK DETAILS

Joifays

Trademark Type

Standard Characters

Goods

Class 28

arcade video game machines; archery bowstrings; balls for playing soccer; bobble head dolls; carnival masks; Christmas trees of synthetic material; electronic action toys; Go board games; kites; leashes used for mountain climbing; pet toys; play motor cars; playing cards; puppets; skateboards; sport gloves; stacking blocks; tennis rackets; treadmills

Application Number 2,052,844
Language of Application English

Filing Date 2020-09-21

APPLICANT DETAILS

Applicant

Fujian Quanzhou Bailida Footwear Co., Ltd.
Heshi Industrial Zone, Luojiang District,
Quanzhou,
CHINA

TRADEMARK DETAILS

Trademark Type

Design

Visual Representation

HAVANSIDY

Goods

Class 25

bathing drawers; bathing suits; boots; casual clothing; coats; dresses; jackets; jumpers; knit tops; pants; pyjamas; shirts; shoes; short-sleeve shirts; skirts; sports jerseys; sports shoes; sweaters; tee-shirts; vests

Application Number 2,052,845
Language of Application English

Filing Date 2020-09-21

APPLICANT DETAILS

Applicant

Haifeng Li
Room AF, Block 8B, Wanke Hanlingcheng
Longping Road West, Longgang District
ShenZhen, 518173
CHINA

TRADEMARK DETAILS

Sunzel

Trademark Type

Standard Characters

Goods

Class 25

bandanas; brassières; corsets; dresses; hats; neckerchiefs; panties; pyjamas; skirts; tee-shirts; trousers

Application Number 2,053,079
Language of Application English

Filing Date 2020-09-22

APPLICANT DETAILS

Applicant
AMLUK LAW PROFESSIONAL
CORPORATION
5600-100 King Street West
Toronto
ONTARIO
m5x1c9

TRADEMARK DETAILS

A Radically Client-Centric Law Firm

Trademark Type
Standard Characters

Services

Class 45

legal services

Application Number 2,053,085
Language of Application English

Filing Date 2020-09-22

APPLICANT DETAILS

Applicant
AMPRSND Inc.
101 Champagne Ave S
Ottawa
ONTARIO
K1S4P3

TRADEMARK DETAILS

AMPRSND

Trademark Type
Standard Characters

Services

Class 45

intellectual property consultancy

Application Number 2,053,093
Language of Application English

Filing Date 2020-09-22

APPLICANT AND AGENT DETAILS

Applicant

AT WORLD PROPERTIES, LLC
806 N Peoria St
Chicago, IL 60642
UNITED STATES OF AMERICA

Agent

FILLMORE RILEY LLP
1700 - 360 Main Street, Winnipeg, MANITOBA,
R3C3Z3

TRADEMARK DETAILS

@PROPERTIES

Trademark Type

Standard Characters

Services

Class 36

real estate brokerage

Application Number 2,053,190
Language of Application English

Filing Date 2020-09-23

APPLICANT DETAILS

Applicant

Majesty Igwenagu
427-629 King St W
Toronto
ONTARIO
M5V0G9

TRADEMARK DETAILS

6ixbraids

Trademark Type
Standard Characters

Services

Class 44

hair braiding services; hair styling services

Application Number 2,053,200
Language of Application English

Filing Date 2020-09-23

APPLICANT DETAILS

Applicant

Lisa Goodall
308 Hillcrest Dr SW
Airdrie
ALBERTA
T4B4C7

TRADEMARK DETAILS

FerroLiner

Trademark Type
Standard Characters

Goods

Class 03
cosmetics

Application Number 2,053,209
Language of Application English

Filing Date 2020-09-23

APPLICANT AND AGENT DETAILS

Applicant

Sanas Health Practice Ltd.
1164 Notre Dame Dr
P.O. Box 96
Petersburg
ONTARIO
N0B2H0

Agent

ANITA MAR
dba Trademark Angel , Suite 521, 6-2557
Dougall Avenue, Windsor, ONTARIO, N8X1T5

TRADEMARK DETAILS

QUEEN OF THE THRONES

Trademark Type

Standard Characters

Goods

Class 05

castor oil for medical purposes

Services

Class 41

meditation counselling; meditation training

Application Number 2,053,464
International Registration Number 1551864
Language of Application English

Filing Date 2020-06-23

APPLICANT AND AGENT DETAILS

Applicant

Moly-Cop Global Holdings Inc.
Level 2, Suite 270
2111 South 67th Street
Omaha NE 68106
UNITED STATES OF AMERICA

Agent

SMART & BIGGAR LLP
SUITE 900, 55 METCALFE STREET, P.O.
BOX 2999, STATION D, OTTAWA, ONTARIO,
K1P5Y6

TRADEMARK DETAILS

MOLYCOP

Trademark Type

Standard Characters

Goods

Class 06

Metal grinding media in the nature of metal balls, metal rods, metal cylpebs being tapered cylindrical grinding beads, metal slugs, and metal cones, all of the foregoing for use in grinding processes; steel alloy grinding balls for use in grinding processes.

Claims

Priority Filing Date: June 15, 2020, Country or Office: UNITED STATES OF AMERICA, Application No: 90001550 in association with the same kind of goods

Application Number 2,055,238
Language of Application English

Filing Date 2020-10-01

APPLICANT DETAILS

Applicant

CHRCH Fitness Inc.
2-107 1st St W
North Vancouver
BRITISH COLUMBIA
V7M1B1

TRADEMARK DETAILS

CHRCH Fitness

Trademark Type

Standard Characters

Services

Class 38

(1) providing streaming audio and video such as music, movies, television shows, music videos, news and sports webcasts via a website; streaming of audio and video via the Internet featuring music, movies, news, and sports

Class 41

(2) conducting fitness classes; developing fitness programs; fitness training; personal fitness training services; providing information in the field of exercise via an interactive website

Application Number 2,055,628
Language of Application English

Filing Date 2020-10-05

APPLICANT DETAILS

Applicant

Campus Intercept Inc. o/a Intercept Group
251 Consumers Rd
Suite 301
North York
ONTARIO
M2J4R3

TRADEMARK DETAILS

Tribe Blueprint

Trademark Type

Standard Characters

Services

Class 35

advice relating to the organisation and management of business; advisory services for business management; advisory services relating to business management; advisory services relating to business management and business operations; Assistance, advisory services and consultancy with regard to business organization; business efficiency services; business management advice; business management analysis; business management and advice; business management and enterprise organization consultancy; business management and organization consultancy; business management assistance; business management consultancy; business management consultancy and advisory services; business management consultancy as well as development of processes for the analysis and the implementation of strategy plans and management projects; business management consultancy services; business management consultation; business management consulting; business management planning; business management supervision; business strategic planning services; business strategy development services; business succession planning; consultancy relating to personnel management; consulting in the fields of business organization and management; consulting services in business organization and management; personnel management assistance services; personnel management consultancy; personnel management consultation; personnel management consulting; providing operational business assistance to enterprises; strategic business planning

Application Number 2,055,833
Language of Application English

Filing Date 2020-10-06

APPLICANT AND AGENT DETAILS

Applicant

Netflix Studios, LLC
5808 W. Sunset Blvd.
Los Angeles, CA 90028
UNITED STATES OF AMERICA

Agent

CLARK WILSON LLP
900 - 885 WEST GEORGIA STREET,
VANCOUVER, BRITISH COLUMBIA, V6C3H1

TRADEMARK DETAILS

LOST OLLIE

Trademark Type

Standard Characters

Services

Class 41

Entertainment services in the nature of a comedic drama television series; providing online non-downloadable video clips and multimedia entertainment recordings containing audio files, video files, artwork, and informational text from and related to a comedic drama television series

Application Number 2,055,930
Language of Application English

Filing Date 2020-10-06

APPLICANT AND AGENT DETAILS

Applicant

Parachute Digital Solutions Inc. / Parachute
Solutions Numériques Inc.
390 Bay Street
27th Floor
Toronto
ONTARIO
M5H2Y2

Agent

TORYS LLP
SUITE 3000, 79 WELLINGTON ST. W., BOX
270, TD CENTRE, TORONTO, ONTARIO,
M5K1N2

TRADEMARK DETAILS

Trademark Type

Design

Visual Representation



Services

Class 36

insurance services

Application Number 2,055,934
Language of Application English

Filing Date 2020-10-06

APPLICANT AND AGENT DETAILS

Applicant

Parachute Digital Solutions Inc. / Parachute
Solutions Numériques Inc.
390 Bay Street
27th Floor
Toronto
ONTARIO
M5H2Y2

Agent

TORYS LLP
SUITE 3000, 79 WELLINGTON ST. W., BOX
270, TD CENTRE, TORONTO, ONTARIO,
M5K1N2

TRADEMARK DETAILS

Trademark Type

Design

Visual Representation



Services

Class 36

insurance services

Application Number 2,056,352
International Registration Number 1554125
Language of Application English

Filing Date 2020-08-07

APPLICANT AND AGENT DETAILS

Applicant

GC Corporation
584-1, Nakahinata,
Oyama-cho, Suntou-gun
Shizuoka 410-1307
JAPAN

Agent

MARKS & CLERK
33 Yonge Street, , Suite 300, Toronto,
ONTARIO, M5E1G4

TRADEMARK DETAILS

G-CEM ONE

Trademark Type

Standard Characters

Goods

Class 05

Dental cements; dental composite materials; materials for repairing teeth; materials for repairing teeth and for dental crowns and bridges; dental restoration compounds; dental resins for temporary bridges, crowns and veneers; fixing materials for dental purposes; dental sealants; dental ceramics; materials for dental sealing purposes; dental impression materials; dental waxes.

Claims

Priority Filing Date: July 27, 2020, Country or Office: JAPAN, Application No: 2020-091941 in association with the same kind of goods

Application Number 2,056,493
International Registration Number 1554799
Language of Application English

Filing Date 2020-08-27

APPLICANT AND AGENT DETAILS

Applicant

Aerzener Maschinenfabrik GmbH
Reherweg 28
31855 Aerzen
GERMANY

Agent

SANDRINE PERNOD-BOULANGER
4847 Westmount Avenue, Westmount,
QUEBEC, H3Y1X9

TRADEMARK DETAILS

Trademark Type

Design

Visual Representation



Goods

Class 07

(1) Apparatus for air and gas conveyance and compression, namely, blowers, densifiers, air compressors, turbocompressors, rotary compressors, compressed gas coolers, rotary piston blowers for pressure and vacuum, rotary lobe pumps; densifiers and air compressors to maintain pressure and flow of gas within overland gas transport pipelines

Class 11

(2) Overland gas transport pipelines and parts therefor, namely barrier devices, valves, refrigerating and heating devices.

Services

Class 37

Construction of pipelines; laying, construction and repair of gas transport pipelines laid overland and undersea

Claims

Priority Filing Date: February 28, 2020, Country or Office: EUIPO (EU), Application No: 018203729
in association with the same kind of goods and in association with the same kind of services

Application Number 2,056,701
Language of Application English

Filing Date 2020-10-08

APPLICANT AND AGENT DETAILS

Applicant

Société des Produits Nestlé S.A.
Avenue Nestlé 55
1800 VEVEY,
SWITZERLAND

Agent

EMMANUELLE PARÉ
CP 161, Saint-Philippe BP, QUEBEC, J0L2K0

TRADEMARK DETAILS

FANCY FEAST GEMS

Trademark Type

Standard Characters

Goods

Class 31

Food for animals, namely, food for pets.

Application Number 2,056,981
Language of Application English

Filing Date 2020-10-10

APPLICANT DETAILS

Applicant

Maison De Mioche Inc.
1801-1 Yonge St
Toronto
ONTARIO
M5E1W7

TRADEMARK DETAILS

FROM DISASTERS EMERGE MASTERS

Trademark Type

Standard Characters

Goods

Class 18

(1) all-purpose athletic bags; animal leads; baby backpacks; baby changing bags; bags for carrying animals; clothing for animals; collars for dogs; dog apparel; duffle bags; infant carriers worn on the body; leashes for pets; schoolchildren's backpacks; wallets

Class 25

(2) adult sweatpants; athletic apparel; athletic footwear; baby clothing; bathing suits; children's clothing; children's footwear; hats; hooded sweatshirts; infant footwear; pyjamas; shorts; socks; sweatshirts; underwear

Services

Class 35

online sales of clothing; online sales of footwear; online sales of headwear

Application Number 2,057,427
International Registration Number 1555862
Language of Application English

Filing Date 2020-03-26

APPLICANT AND AGENT DETAILS

Applicant

WACOAL CORP.
29, Nakajima-cho,
Kisshoin,
Minami-ku,
Kyoto-shi
Kyoto 601-8530
JAPAN

Agent

SMART & BIGGAR LLP
SUITE 900, 55 METCALFE STREET, P.O.
BOX 2999, STATION D, OTTAWA, ONTARIO,
K1P5Y6

TRADEMARK DETAILS

Trademark Type

Design

Visual Representation

The logo for Wacoal, featuring the word "Wacoal" in a bold, sans-serif font. The letter 'W' is significantly larger and more stylized than the other letters, which are in a standard weight.

Goods

Class 25

Clothing, namely, bikini tops, fleece tops, knit tops, tennis tops, tube tops; non-Japanese style outerclothing, namely, jackets, overcoats; coats; sweaters; cardigans; vests; shirts; nightwear; underwear; swimming caps; camisoles; tank-tops; tee-shirts; Japanese traditional clothing; sleep masks; aprons; socks; puttees and gaiters; fur stoles; shawls; scarves; Japanese style socks (tabi); Japanese style socks covers (tabi covers); gloves and mittens; neckties; neckerchieves; bandanas; thermal supporters being clothing, namely, thermal underwear, thermal socks, thermal belly support bands, knee warmers; mufflers as neck scarves; ear muffs; nightcaps; headgear for wear, namely, sun visors, toques, balaclavas; garters; sock suspenders; suspenders; waistbands; belts being clothing; footwear, except orthopedic footwear, namely, outdoor winter footwear, tips for footwear, welts for footwear; shoes and boots; Japanese style wooden clogs (geta); Japanese style sandals (zori); masquerade costumes; special footwear for sports, other than horse-riding boots and windsurfing shoes; horse-riding boots; shoes for windsurfing; clothes for sports; clothes for water sports; brassieres; bralettes; shapewear; foundation garments; girdles; shorts; panties; lingerie; slippers; clothing for gymnastics; tights for sports; sports bras; shorts for sports; beach clothes; pajamas; body stockings; casual trousers; skirts; jackets being clothing; swimwear; sports socks; sports jackets; sport shirts; pumps being footwear; sneaker; hoods, namely, ski hoods, fleece hoods; sedge hats (suge-gasa); tongue or pullstrap for shoes and boots; housecoats; belly band; bibs for babies, not of paper; corsets being underclothing; petticoats; sweat-absorbent underwear; leg warmers; tights; spats; bra straps being parts of clothing; removable bra straps being parts of clothing; padded underwear for body shape adjustment used by wrapping around the waist against the top of the hip; removable breast enhancer pads being parts of clothing; nipple

cover formed by applying an adhesive and sticking a release paper being parts of clothing; seals for adherent plaster-like nipple to be affixed to human nipple being parts of clothing; helmet liners [headwear]; swimsuits; body shapers; body suits; body briefs; sandals; bra-slips; half slips; negligees; bathrobes; night gowns; house coats; lounge coats; leggings; slippers; caps being headwear; hats; outerwear, namely, rain boots, rain suits; dresses; one-piece dresses; blouses; pants; dresses to wear over swimsuits; tunics and kaftans to wear over swimsuits; sarongs and pareos to wear over swimsuits; extenders for brassieres being parts of clothing

Services

Class 35

Retail or wholesale services for woven fabrics and beddings; retail or wholesale services for clothing; retail or wholesale services for headgear; retail or wholesale services for diapers; retail or wholesale services for footwear, other than special footwear for sports; retail or wholesale services for bags and pouches; retail or wholesale services for personal articles, namely, absorbent pads for incontinence, perspiration absorbent underwear clothing, towels of textile and handkerchiefs, insignias for wear, not of precious metal, insignias for wear of precious metal, buckles for clothing [clothing buckles], ornamental badges for wear, brooches for clothing, ornamental adhesive patches for jackets, brassards, cuff links, buttons for clothing; retail or wholesale services for furniture; retail or wholesale services for kitchen equipment, cleaning tools and washing utensils; retail or wholesale services for cosmetics, toiletries, dentifrices, soaps and detergents; retail or wholesale services for stationery; retail or wholesale services for toys, dolls, game machines and apparatus; retail or wholesale services for fragrant sachets; retail or wholesale services for laundry basket and laundry net; retail or wholesale services for sanitary shorts; retail or wholesale services for appliques being haberdashery; retail or wholesale services for underwear body shape adjustment pad used by wrapping around the waist against the top of the hip; retail or wholesale services for removable breast enhancer pads used in a bra, fasteners for bras being lingerie accessories, bra strap extenders being lingerie accessories and bra straps being parts of clothing; retail or wholesale services for lingerie accessories, namely, removable shoulder straps for use with bras; retail or wholesale services for removable shoulder straps for use with bra; retail or wholesale services for lingerie accessories, namely, nipple covering pads formed by applying an adhesive and sticking a release paper; retail or wholesale services for lingerie accessories, namely, seals for adherent plaster-like nipple to be affixed to human nipple; retail or wholesale services for bra pads for clothing, underwear body shape adjustment pads used by wrapping around the waist against the top of the hip for clothing, fasteners for bras and removable shoulder straps for use with bras for clothing; retail or wholesale services for hip pads, bra strap extenders, removable shoulder straps for use with bras; retail or wholesale services for bra straps being parts of clothing; presentation in the nature of promotion of goods for others on communication media via the Internet, social media, for retail purposes; administration of consumer loyalty programs; providing user reviews of goods and services for commercial or advertising purposes in the field of clothing, footwear, headwear, and bags; consultancy relating to sales promotions; sales promotion for others by means of privileged user cards; arranging of advertising and promotion contracts for third parties; provision of an online marketplace for buyers and sellers of goods and services; business consulting on sales of underwear utilizing a instruction on how to wear underwear; advertising of goods and services of others via local and global computer networks; organization of trade show exhibitions in the field of clothing, footwear, headwear, and bags for commercial or advertising purposes; organization of fashion shows for promotional purposes; business management analysis or business consultancy; business management; marketing research or analysis; providing business information concerning commercial sales in the field of clothing, footwear, headwear and bags; providing commercial information and advice for consumers in the

choice of products and services in the field of clothing, footwear, headwear, and bags; providing advice or information on purchasing the best products for consumers in the field of clothing, footwear, headwear, and bags; providing advice and information on choosing underwear for consumers; retail and wholesale services for underwear; retail and wholesale services for brassieres; retail and wholesale services for bralettes; retail and wholesale services for shapewear; retail and wholesale services for foundation garments; retail and wholesale services for girdles; retail and wholesale services for shorts; retail and wholesale services for panties; retail and wholesale services for lingerie; retail and wholesale services for camisoles; retail and wholesale services for slippers; retail and wholesale services for garters; retail and wholesale services for sports clothing, not as athletic equipment; retail and wholesale services for gymnastic clothing, not as athletic equipment; retail and wholesale services for sports tights, not as athletic equipment; retail and wholesale services for sports bras; retail and wholesale services for sports shorts; retail and wholesale services for swimwear; retail and wholesale services for swimsuits; retail and wholesale services for beach clothes; retail and wholesale services for nightwear; retail or wholesale services for tights

Claims

Priority Filing Date: March 02, 2020, Country or Office: JAPAN, Application No: 2020-022634 in association with the same kind of goods and in association with the same kind of services

Application Number 2,057,428
International Registration Number 1555897
Language of Application English

Filing Date 2020-03-26

APPLICANT AND AGENT DETAILS

Applicant

WACOAL CORP.
29, Nakajima-cho,
Kisshoin,
Minami-ku,
Kyoto-shi
Kyoto 601-8530
JAPAN

Agent

SMART & BIGGAR LLP
SUITE 900, 55 METCALFE STREET, P.O.
BOX 2999, STATION D, OTTAWA, ONTARIO,
K1P5Y6

TRADEMARK DETAILS

Trademark Type

Design

Visual Representation



Goods

Class 25

Clothing, namely, bikini tops, fleece tops, knit tops, tennis tops, tube tops; non-Japanese style outerclothing, namely, jackets, overcoats; coats; sweaters; cardigans; vests; shirts; nightwear; underwear; swimming caps; camisoles; tank-tops; tee-shirts; Japanese traditional clothing; sleep masks; aprons; socks; puttees and gaiters; fur stoles; shawls; scarves; Japanese style socks (tabi); Japanese style socks covers (tabi covers); gloves and mittens; neckties; neckerchieves; bandanas; thermal supporters being clothing, namely, thermal underwear, thermal socks, thermal belly support bands, knee warmers; mufflers as neck scarves; ear muffs; nightcaps; headgear for wear, namely, sun visors, toques, balaclavas; garters; sock suspenders; suspenders; waistbands; belts being clothing; footwear, except orthopedic footwear, namely, outdoor winter footwear, tips for footwear, welts for footwear; shoes and boots; Japanese style wooden clogs (geta); Japanese style sandals (zori); masquerade costumes; special footwear for sports, other than horse-riding boots and windsurfing shoes; horse-riding boots; shoes for windsurfing; clothes for sports; clothes for water sports; brassieres; bralettes; shapewear; foundation garments; girdles; shorts; panties; lingerie; slippers; clothing for gymnastics; tights for sports; sports bras; shorts for sports; beach clothes; pajamas; body stockings; casual trousers; skirts; jackets being clothing; swimwear; sports socks; sports jackets; sport shirts; pumps being footwear; sneaker; hoods, namely, ski hoods,

fleece hoods; sedge hats (suge-gasa); tongue or pullstrap for shoes and boots; housecoats; belly band; bibs for babies, not of paper; corsets being underclothing; petticoats; sweat-absorbent underwear; leg warmers; tights; spats; bra straps being parts of clothing; removable bra straps being parts of clothing; padded underwear for body shape adjustment used by wrapping around the waist against the top of the hip; removable breast enhancer pads being parts of clothing; nipple cover formed by applying an adhesive and sticking a release paper being parts of clothing; seals for adherent plaster-like nipple to be affixed to human nipple being parts of clothing; helmet liners [headwear]; swimsuits; body shapers; body suits; body briefs; sandals; bra-slips; half slips; negligees; bathrobes; night gowns; house coats; lounge coats; leggings; slippers; caps being headwear; hats; outerwear, namely, rain boots, rain suits; dresses; one-piece dresses; blouses; pants; dresses to wear over swimsuits; tunics and kaftans to wear over swimsuits; sarongs and pareos to wear over swimsuits; extenders for brassieres being parts of clothing

Services

Class 35

Retail or wholesale services for woven fabrics and beddings; retail or wholesale services for clothing; retail or wholesale services for headgear; retail or wholesale services for diapers; retail or wholesale services for footwear, other than special footwear for sports; retail or wholesale services for bags and pouches; retail or wholesale services for personal articles, namely, absorbent pads for incontinence, perspiration absorbent underwear clothing, towels of textile and handkerchiefs, insignias for wear, not of precious metal, insignias for wear of precious metal, buckles for clothing [clothing buckles], ornamental badges for wear, brooches for clothing, ornamental adhesive patches for jackets, brassards, cuff links, buttons for clothing; retail or wholesale services for furniture; retail or wholesale services for kitchen equipment, cleaning tools and washing utensils; retail or wholesale services for cosmetics, toiletries, dentifrices, soaps and detergents; retail or wholesale services for stationery; retail or wholesale services for toys, dolls, game machines and apparatus; retail or wholesale services for fragrant sachets; retail or wholesale services for laundry basket and laundry net; retail or wholesale services for sanitary shorts; retail or wholesale services for appliques being haberdashery; retail or wholesale services for underwear body shape adjustment pad used by wrapping around the waist against the top of the hip; retail or wholesale services for removable breast enhancer pads used in a bra, fasteners for bras being lingerie accessories, bra strap extenders being lingerie accessories and bra straps being parts of clothing; retail or wholesale services for lingerie accessories, namely, removable shoulder straps for use with bras; retail or wholesale services for removable shoulder straps for use with bra; retail or wholesale services for lingerie accessories, namely, nipple covering pads formed by applying an adhesive and sticking a release paper; retail or wholesale services for lingerie accessories, namely, seals for adherent plaster-like nipple to be affixed to human nipple; retail or wholesale services for bra pads for clothing, underwear body shape adjustment pads used by wrapping around the waist against the top of the hip for clothing, fasteners for bras and removable shoulder straps for use with bras for clothing; retail or wholesale services for hip pads, bra strap extenders, removable shoulder straps for use with bras; retail or wholesale services for bra straps being parts of clothing; presentation in the nature of promotion of goods for others on communication media via the Internet, social media, for retail purposes; administration of consumer loyalty programs; providing user reviews of goods and services for commercial or advertising purposes in the field of clothing, footwear, headwear, and bags; consultancy relating to sales promotions; sales promotion for others by means of privileged user cards; arranging of advertising and promotion contracts for third parties; provision of an online marketplace for buyers and sellers of goods and services; business consulting on sales of underwear utilizing a instruction on how to wear underwear; advertising of goods and services of others via local and global computer networks; organization of

trade show exhibitions in the field of clothing, footwear, headwear, and bags for commercial or advertising purposes; organization of fashion shows for promotional purposes; business management analysis or business consultancy; business management; marketing research or analysis; providing business information concerning commercial sales in the field of clothing, footwear, headwear and bags; providing commercial information and advice for consumers in the choice of products and services in the field of clothing, footwear, headwear, and bags; providing advice or information on purchasing the best products for consumers in the field of clothing, footwear, headwear, and bags; providing advice and information on choosing underwear for consumers; retail and wholesale services for underwear; retail and wholesale services for brassieres; retail and wholesale services for bralettes; retail and wholesale services for shapewear; retail and wholesale services for foundation garments; retail and wholesale services for girdles; retail and wholesale services for shorts; retail and wholesale services for panties; retail and wholesale services for lingerie; retail and wholesale services for camisoles; retail and wholesale services for slips; retail and wholesale services for garters; retail and wholesale services for sports clothing, not as athletic equipment; retail and wholesale services for gymnastic clothing, not as athletic equipment; retail and wholesale services for sports tights, not as athletic equipment; retail and wholesale services for sports bras; retail and wholesale services for sports shorts; retail and wholesale services for swimwear; retail and wholesale services for swimsuits; retail and wholesale services for beach clothes; retail and wholesale services for nightwear; retail or wholesale services for tights

Claims

Priority Filing Date: March 02, 2020, Country or Office: JAPAN, Application No: 2020-022635 in association with the same kind of goods and in association with the same kind of services

Application Number 2,057,891
Language of Application English

Filing Date 2020-10-15

APPLICANT AND AGENT DETAILS

Applicant

The Delfield Company LLC
980 South Isabella Road
Mount Pleasant, Michigan 48858
UNITED STATES OF AMERICA

Agent

MILLER IP LAW
84 Neilson Drive, Toronto, ONTARIO, M9C1V7

TRADEMARK DETAILS

FLEXITOP

Trademark Type

Standard Characters

Goods

Class 11

Single tier hot shelves; single tier cold shelves; dual tier hot shelves; dual tier cold shelves; heated food display and serving units; refrigerated food supply and serving units

Claims

Priority Filing Date: October 14, 2020, Country or Office: UNITED STATES OF AMERICA,
Application No: 90/253,892 in association with the same kind of goods

Application Number 2,059,074
International Registration Number 1556863
Language of Application French

Filing Date 2020-08-14

APPLICANT AND AGENT DETAILS

Applicant

Onward Therapeutics SA
4, route de la Corniche, bat. SC-A
CH-1066 Epalinges
SUISSE

Agent

GOWLING WLG (CANADA) LLP
1 PLACE VILLE MARIE, 37TH FLOOR/37E
ETAGE, MONTREAL, QUÉBEC, H3B3P4

TRADEMARK DETAILS

ONWARD THERAPEUTICS

Trademark Type

Standard Characters

Goods

Class 05

Pharmaceutical preparations for the treatment of oncological diseases and disorders; pharmaceutical preparations for use in oncology; biopharmaceuticals for the prevention and treatment of cancer; preparations for detecting genetic predispositions, for medical use; chemical, biochemical and biological preparations for detecting genetic predispositions, for medical use; chemical and biological diagnostic reagents for medical use; clinical diagnostic reagents; medical diagnostic reagents; reactive preparations for medical diagnosis; chemical reagents and diagnostic products for clinical and medical laboratories, namely chemical and biopharmaceuticals preparations used on laboratories for diagnosing cancer; diagnostic preparations for clinical and medical laboratories; reactive preparations for clinical and medical laboratories; chemical diagnostic reagents for medical use; clinical diagnostic reagents; medical diagnostic reagents.

Services

Class 42

Scientific and technological research in the field of oncology; scientific research regarding cancer; product development services in the fields of science, biology, medicine and pharmaceuticals; scientific and technological research for the development of diagnostic tests related to oncology; scientific and technological research for the development of diagnostic tests for cancer detection. .

Claims

Priority Filing Date: May 08, 2020, Country or Office: SWITZERLAND, Application No: 750635 in association with the same kind of goods and in association with the same kind of services

Application Number 2,059,113
International Registration Number 1556643
Language of Application English

Filing Date 2020-08-25

APPLICANT AND AGENT DETAILS

Applicant

Zanoprima Lifesciences Limited
5th Floor Charles House,
108/110 Finchley Road
London NW3 5JJ
UNITED KINGDOM

Agent

OYEN WIGGS GREEN & MUTALA LLP
480-THE STATION, 601 WEST CORDOVA
STREET, VANCOUVER, BRITISH
COLUMBIA, V6B1G1

TRADEMARK DETAILS

SYNIC

Trademark Type

Standard Characters

Goods

Class 01

(1) Chemicals for use in the electronic cigarette industry; chemicals for use in the manufacture of nicotine solutions; active pharmaceutical ingredients for use in the manufacture of synthetic nicotine; synthetic nicotine for use in the manufacture of electronic smoking vaporizer refills

Class 05

(2) Synthetic nicotine patches for use as aids to stop smoking; synthetic nicotine gum for use as an aid to stop smoking; synthetic nicotine lozenges for use as aids to stop smoking; synthetic nicotine for use as an aid to stop smoking

Class 34

(3) Liquid nicotine solutions for electronic cigarettes; synthetic nicotine solutions for electronic cigarettes; smokers' oral vaporizer refill cartridges for electronic cigarettes; electronic nicotine inhalation devices, namely electronic cigarettes; electronic smoking pipes; electronic heaters to facilitate inhalation of nicotine containing aerosol; electronic handheld generators for inhalation of nicotine containing aerosol; electronic vaporizers for inhalation of nicotine containing aerosol; electronic cigarettes for inhalation of nicotine containing aerosol; oral vaporizers for smokers; electronic cigarettes; electric vaporizers for the vaporization of tobacco; tobacco free oral nicotine pouches (not for medical use); electronic cigarette refill liquids; smokeless cigarette vaporizer pipes; tobacco substitutes in liquid solution form other than for medical purposes for electronic cigarettes; electronic cigarette components in the nature of electronic nicotine inhalation devices comprised of electronic cigarette refill cartridges, electronic cigarette atomizers and refill liquid nicotine solutions distributed as a unit; electronic cigarette accessories, namely, electronic cigarette cases, electronic cigarette mouth guards and electronic cigarette adapters; cartridges sold filled with synthetic liquid nicotine for electronic cigarettes; ampoules, cartridges and refill cartridges for electronic smoking pipes and electronic cigarettes; cases and holders for electronic nicotine inhalation devices, namely, electronic heaters to facilitate inhalation of nicotine containing aerosol and electronic handheld generators for inhalation of nicotine containing aerosol

Claims

Priority Filing Date: July 07, 2020, Country or Office: UNITED KINGDOM, Application No: UK00003509057 in association with the same kind of goods

Application Number 2,060,737
International Registration Number 1557951A
Language of Application English

Filing Date 2020-07-07

APPLICANT AND AGENT DETAILS

Applicant

Nintendo of America Inc.
4600 150th Avenue NE
Redmond WA 98052
UNITED STATES OF AMERICA

Agent

SMART & BIGGAR LLP
2300 - 1055 West Georgia Street, P.O. Box
11115, Vancouver, BRITISH COLUMBIA,
V6E3P3

TRADEMARK DETAILS

EXCITE TRUCK

Trademark Type

Standard Characters

Goods

Class 09

Recorded electronic game programs; downloadable electronic game programs; recorded video game programs; downloadable video game programs; video game cartridges; memory cards for video game machines; cases for smartphones; covers for smartphones; recorded computer game software; downloadable computer games; downloadable image files containing artwork, text, audio, videos relating to video games; downloadable music files; downloadable electronic publications, namely fiction stories, booklets, manuals and newsletters in the field of video games; headphones; earphones.

Claims

Priority Filing Date: May 12, 2020, Country or Office: JAPAN, Application No: 2020-058984 in association with the same kind of goods

Application Number 2,060,738
International Registration Number 1557914A
Language of Application English

Filing Date 2020-07-07

APPLICANT AND AGENT DETAILS

Applicant

Nintendo of America Inc.
4600 150th Avenue NE
Redmond WA 98052
UNITED STATES OF AMERICA

Agent

SMART & BIGGAR LLP
2300 - 1055 West Georgia Street, P.O. Box
11115, Vancouver, BRITISH COLUMBIA,
V6E3P3

TRADEMARK DETAILS

Trademark Type

Design

Visual Representation

The image shows the 'Wii U' logo in a light gray, sans-serif font. The 'W' is the largest, followed by 'ii' and 'U'. The 'i's have dots, and the 'U' has a small notch at the bottom.

Goods

Class 09

(1) Recorded electronic game programs; downloadable electronic game programs; recorded video game programs; downloadable video game programs; video game cartridges; memory cards for video game machines; cases for smartphones; covers for smartphones; recorded computer game software; downloadable computer games; downloadable image files containing artwork, text, audio, videos relating to video games; downloadable music files; downloadable electronic publications, namely fiction stories, booklets, manuals and newsletters in the field of video games; headphones; earphones; electric batteries for home video game machines.

Class 28

(2) Games, namely card games, promotional game cards, puzzles, trading card games; toys, namely toy balls, toy key chains, toy figures, water toys, plush toys, inflatable toys, party favors in the nature of small toys, toy balloons, toy building blocks, toy vehicle; portable games with liquid crystal displays; protective films adapted for screens for portable games; video game machines; controllers for game consoles; hand-held units for playing video games; arcade video game machines; ornaments for Christmas trees, except lights, candles and confectionery; protective carrying cases specially adapted for handheld video games.

Services

Class 41

Entertainment services, namely providing non-downloadable images featuring images of characters and scenes from an electronic game via a global computer network and wireless networks; entertainment services, namely providing non-downloadable prerecorded music and sounds in the field of video games, all on-line via a global computer network; entertainment

services, namely providing temporary use of non-downloadable video games; providing entertainment information on video games and related video gaming products; providing non-downloadable online electronic publications namely, online journals and interactive online blogs featuring user generated or specified content in the field of video games and online publication of electronic books and magazines; providing non-downloadable online videos featuring video games via the Internet; providing non-downloadable music via the Internet; rental of game machines; toy rental; providing online video gaming services; organization of electronic game competitions for entertainment purposes; providing amusement arcade services.

Claims

Priority Filing Date: May 12, 2020, Country or Office: JAPAN, Application No: 2020-058987 in association with the same kind of goods and in association with the same kind of services

Application Number 2,060,740
International Registration Number 1557775A
Language of Application English

Filing Date 2020-07-09

APPLICANT AND AGENT DETAILS

Applicant

Nintendo of America Inc.
4600 150th Avenue NE
Redmond WA 98052
UNITED STATES OF AMERICA

Agent

SMART & BIGGAR LLP
2300 - 1055 West Georgia Street, P.O. Box
11115, Vancouver, BRITISH COLUMBIA,
V6E3P3

TRADEMARK DETAILS

FACE RAIDERS

Trademark Type

Standard Characters

Goods

Class 09

Recorded electronic game programs; downloadable electronic game programs; recorded video game programs; downloadable video game programs; video game cartridges; memory cards for video game machines; cases for smartphones; covers for smartphones; downloadable computer games; recorded computer game software; headphones; downloadable image files containing artwork, text, audio, videos relating to video games; downloadable music files; downloadable electronic publications, namely fiction stories, booklets, manuals and newsletters in the field of video games.

Claims

Priority Filing Date: January 15, 2020, Country or Office: JAPAN, Application No: 2020-004183 in association with the same kind of goods

Application Number 2,060,743
International Registration Number 1557823A
Language of Application English

Filing Date 2020-07-09

APPLICANT AND AGENT DETAILS

Applicant

Nintendo of America Inc.
4600 150th Avenue NE
Redmond WA 98052
UNITED STATES OF AMERICA

Agent

SMART & BIGGAR LLP
2300 - 1055 West Georgia Street, P.O. Box
11115, Vancouver, BRITISH COLUMBIA,
V6E3P3

TRADEMARK DETAILS

SUPER MARIO WORLD

Trademark Type

Standard Characters

Goods

Class 09

Recorded electronic game programs; downloadable electronic game programs; recorded video game programs; downloadable video game programs; video game cartridges; memory cards for video game machines; cases for smartphones; covers for smartphones; downloadable computer games; recorded computer game software; headphones; downloadable image files containing artwork, text, audio, videos relating to video games; downloadable music files; downloadable electronic publications, namely fiction stories, booklets, manuals and newsletters in the field of video games.

Claims

Priority Filing Date: January 15, 2020, Country or Office: JAPAN, Application No: 2020-004208 in association with the same kind of goods

Application Number 2,060,747
International Registration Number 1557702A
Language of Application English

Filing Date 2020-07-13

APPLICANT AND AGENT DETAILS

Applicant

Nintendo of America Inc.
4600 150th Avenue NE
Redmond WA 98052
UNITED STATES OF AMERICA

Agent

SMART & BIGGAR LLP
2300 - 1055 West Georgia Street, P.O. Box
11115, Vancouver, BRITISH COLUMBIA,
V6E3P3

TRADEMARK DETAILS

MARIO VS. DONKEY KONG MINIS MARCH AGAIN!

Trademark Type

Standard Characters

Goods

Class 09

Recorded electronic game programs; downloadable electronic game programs; recorded video game programs; downloadable video game programs; video game cartridges; memory cards for video game machines; cases for smartphones; covers for smartphones; downloadable computer games; recorded computer game software; headphones; downloadable image files containing artwork, text, audio, videos relating to video games; downloadable music files; downloadable electronic publications, namely fiction stories, booklets, manuals and newsletters in the field of video games.

Claims

Priority Filing Date: January 15, 2020, Country or Office: JAPAN, Application No: 2020-004195 in association with the same kind of goods

Application Number 2,061,881
International Registration Number 1558840
Language of Application English

Filing Date 2020-06-05

APPLICANT AND AGENT DETAILS

Applicant

Quicksilver Midco Limited
Ascot Business Park,
50 Longbridge Lane
Derby DE24 8UJ
UNITED KINGDOM

Agent

CABINET JURIDIQUE ST. LAWRENCE S.E.N.
C.R.L.
2301, Saint-Patrick Street, Suite B6, Montreal,
QUEBEC, H3K1B3

TRADEMARK DETAILS

INCORA

Trademark Type

Standard Characters

Goods

Class 09

Supply chain management software in the aerospace and defence, aviation maintenance, repair and overhaul, government, automotive and truck OEM, industrial and commercial manufacturing, consumer electronics, energy, food and beverage, pharmaceutical and healthcare industries, software for the procurement of goods and services, inventory management software, parts and fittings for the aforesaid goods.

Services

Class 35

(1) Supply chain management services, inventory management of parts and components, outsourcing services in the nature of procuring parts and components for others, outsourcing services in the nature of arranging procurement of goods for others; procurement of goods on behalf of other businesses, all of the aforesaid services for aerospace and defence, aviation maintenance, repair and overhaul, government, automotive and truck OEM, industrial and commercial manufacturing, consumer electronics, energy, food and beverage, pharmaceutical and healthcare industries, information, advisory and consultancy services relating to all the aforementioned services.

Class 39

(2) Packaging, storage and delivery of goods for others by air, rail, ship or truck; supply chain logistics and reverse logistics services consisting of the storage, transportation and delivery of goods for others by air, rail, ship or truck, information, advisory and consultancy services relating to all the aforementioned services.

Class 40

(3) Disposal of hazardous waste; treatment of hazardous waste; information, advice and consultancy services relating to the treatment and disposal of hazardous waste.

Claims

Priority Filing Date: February 07, 2020, Country or Office: UNITED KINGDOM, Application No: UK00003465056 in association with the same kind of goods and in association with the same kind of services

Application Number 2,062,228
Language of Application English

Filing Date 2020-11-04

APPLICANT AND AGENT DETAILS

Applicant

MAG CANADA BEVERAGE LTD.
Unit 100 - 565 Great Northern Way
Vancouver
BRITISH COLUMBIA
V5T0H8

Agent

GOWLING WLG (CANADA) LLP
550 BARRARD STREET, SUITE 2300,
VANCOUVER, BRITISH COLUMBIA, V6C2B5

TRADEMARK DETAILS

LEMON LIFE HARD LEMONADE SELTZER

Trademark Type

Standard Characters

Goods

Class 32

(1) ale; beer; beer-based cocktails; flavoured beers; lager; porter; stout;

Class 33

(2) alcoholic cocktails; alcoholic cocktails in the form of chilled gelatins; alcoholic coolers; alcoholic fruit drinks; alcoholic lemonade; alcoholic malt-based coolers; alcoholic punches; alcoholic seltzer; hard seltzer; vodka seltzer;

Application Number 2,062,722
Language of Application English

Filing Date 2020-11-09

APPLICANT AND AGENT DETAILS

Applicant

Joshua Turner
3854 Centennial Dr
Saskatoon
SASKATCHEWAN
S7L5K9

Agent

RYAN SHEBELSKI
Locus Law, 114-310 Wall Street W, Saskatoon,
SASKATCHEWAN, S7K1N7

TRADEMARK DETAILS

Trademark Type

Design

Visual Representation



Goods

Class 25

athletic shoes; baseball caps and hats; boots; casual shoes; gloves; hats; hiking shoes; jackets; long-sleeved t-shirts; pajamas; pants; sandals; sandals and beach shoes; scarves; short-sleeved t-shirts; socks; sweaters; t-shirts; thong sandals; toques; underwear

Application Number 2,063,561
International Registration Number 1556852
Language of Application English

Filing Date 2020-10-28

APPLICANT AND AGENT DETAILS

Applicant

Bertram (1958) Co., Ltd.
37 Soi Ladprao 80 (Chantima) Ladprao Road,
Wangthonglang Sub-district,
Wangthonglang District
10310 Bangkok
THAILAND

Agent

BENNETT JONES LLP
4500 BANKERS HALL EAST, 855 - 2ND
STREET S.W., CALGARY, ALBERTA, T2P4K7

TRADEMARK DETAILS

Trademark Type

Design

Visual Representation



Goods

Class 05

Analgesic balms; mosquito repellents; Medicated inhalants, namely, inhalers with eucalyptus oil and menthol for cold and flu relief; Liquid balms for medical purposes, namely, for the relief of aches, pains and strains; medicated liquid inhalants for cold relief

Application Number 2,066,828
International Registration Number 1562490
Language of Application English

Filing Date 2020-09-02

APPLICANT AND AGENT DETAILS

Applicant

Fujian Sijia Industrial Material Co.,Ltd.
(NO.288 Huanxi Street)
Sijia Industrial Park,
Huanxi Industrial Zone,
Jin'an District, Fuzhou City
Fujian Province
CHINA

Agent

MILTONS IP/P.I.
15 Fitzgerald Rd, Suite 200, Ottawa,
ONTARIO, K2H9G1

TRADEMARK DETAILS

Trademark Type

Design

Visual Representation



Goods

Class 19

(1) Stair-treads [steps] of Thermoplastic polyurethane and Polypropylene; agglomerated cork for building; floor panels of plastic; glass slabs for use in building; non-metal duckboards; non-metallic paving tiles and paving slabs; plastic floorboards; plastic landscape edgings; rubber bearings for seismic isolation of buildings; rubber flooring

Class 27

(2) Anti-static floor mats; carpet underlay; carpets; decorative slip-resistant floor coverings in sheet form; floor mats; non-slip floor mats; non-textile wall hangings; rubber mats; vinyl floor coverings; wallpaper

Application Number 2,066,849
International Registration Number 1561395
Language of Application English

Filing Date 2020-09-08

APPLICANT AND AGENT DETAILS

Applicant

Optos plc
Queensferry House,
Carnegie Business Campus,
Queensferry Road
Dunfermline, Fife KY11 8GR
UNITED KINGDOM

Agent

FASKEN MARTINEAU DUMOULIN LLP
333 BAY STREET, SUITE 2400, BAY
ADELAIDE CENTRE, BOX 20, TORONTO,
ONTARIO, M5H2T6

TRADEMARK DETAILS

SILVERSTONE

Trademark Type

Standard Characters

Goods

Class 09

(1) Surgical microscopes.

Class 10

(2) Ophthalmoscopes; diagnostic optical, optometry and ophthalmic medical apparatus for the detection, diagnosis, management and treatment of eye disease, for the visualisation and documentation of the retina, and for the visualisation of the retina for the detection and management of eye disease, namely, eye testing machines and apparatus, medical eye examination apparatus, scanning laser ophthalmoscopes, optical coherence tomography scanners, ultrasonic medical diagnostic apparatus and medical imaging apparatus incorporating medical imaging software; retinal examination equipment for the detection, diagnosis, management and treatment of eye disease; retinal imaging systems for the detection, diagnosis, management and treatment of eye disease; medical eye examination apparatus for the detection, diagnosis, management and treatment of eye disease; optical inspection apparatus for the detection, diagnosis, management and treatment of eye disease; medical imaging apparatus for the detection, diagnosis, management and treatment of eye disease; medical imaging apparatus comprising optical coherence tomography and ophthalmoscopes for the detection, diagnosis, management and treatment of eye disease; laser beam delivery apparatus for the detection, diagnosis, management and treatment of eye disease; medical apparatus incorporating lasers for the detection, diagnosis, management and treatment of eye disease; medical apparatus incorporating lasers for the detection, diagnosis, management and treatment of eye disease; surgical apparatus, instruments, equipment and devices for the treatment of eye disease; ophthalmic corneal cross-linking devices, photocoagulators, ultrasound retinal scanners, visual acuity systems and perimeters for the detection, diagnosis, management and treatment of eye disease; surgical microscopes; optometric instruments; optomedical examination instruments for the detection, diagnosis, management and treatment of eye disease.

Claims

Priority Filing Date: March 11, 2020, Country or Office: UNITED KINGDOM, Application No: UK00003474198 in association with the same kind of goods

Application Number 2,067,867
International Registration Number 1563390
Language of Application English

Filing Date 2020-09-03

APPLICANT AND AGENT DETAILS

Applicant

ALEXANDROS BEKETOV
3500 S. DuPont Hwy
Dover DE 19901
UNITED STATES OF AMERICA

Agent

NEOMARK LTD.
7450 rue Saint-Hubert, Montréal, QUEBEC,
H2R2N3

TRADEMARK DETAILS

Trademark Type

Design

Visual Representation



Goods

Class 03

(1) Non-medicated cosmetics; hair colorants; after-shave balms; balms to conceal skin imperfections; beauty balm creams; hair balms; lip balms; non-medicated paw balms for pets; non-medicated skin balms for use on pets; shaving balms; hair conditioners; beard dyes; cosmetic hair dyes; bath soaps; beauty soaps; body soaps; cosmetic soaps; cream soaps; facial soaps; granulated soaps; hand soaps; liquid hand soaps; liquid soaps for hands, face and body; liquid soaps for laundry; shower soaps; skin soaps; soaps for household use; soaps for personal use; soaps for toilet purposes; beauty masks; hair lotions; toothpaste; lotions for cosmetic purposes; shampoos; shaving preparations; deodorants for human beings; deodorants for pets; after-shave lotions; cosmetics; mascara; dry shampoos.

Class 05

(2) Analgesic balms; medicated after-shave balms; medicated antiseptic balms; multi-purpose medicated analgesic balms; skin lubricating balms to prevent chaffing; medicated antiperspirant soap; medicated soap for the treatment of rosacea; medicated soaps for babies; anti-fly lotions;

antibacterial hand lotions; athlete's foot lotions; barrier lotions for protection against poisonous plants; barrier lotions for protection from toxic oils of poisonous plants; calamine lotions; insect repellent lotions; medicated after-shave lotions; medicated diaper rash lotions; medicated lotions for sunburn; medicated nappy rash lotions; medicated sunburn lotions; pharmaceutical preparations for treating dandruff; pharmaceutical preparations for hydrating the skin during pregnancy; pharmaceutical preparations for preventing skin blemishes during pregnancy; pharmaceutical preparations for the treatment of bacterial skin infections, fungal skin infections, viral skin infections and parasitic skin infections; pharmaceutical preparations for the treatment of skin irritations, namely bee stings, sunburn, rashes, sores, corns, calluses, and acne; pharmaceutical preparations for treating and preventing skin and nail diseases; pharmaceutical preparations for treating dry skin caused by pregnancy; pharmaceutical preparations for use in dermatology, namely dermatitis, skin pigmentation diseases and treatment of acne; medicinal hair growth preparations; dietary supplements consisting of trace elements; food supplements consisting of trace elements; injectable solutions of trace elements for paediatric use; medicated anti-dandruff shampoos; medicated anti grey hair shampoos;; medicated anti-dandruff hair lotions; medicated anti grey hair lotions;; air deodorants; bathroom deodorants; car deodorants; deodorants for refrigerators; deodorants for upholstery; deodorizers for carpets; deodorizers for garbage disposals; deodorizers for litter trays; room deodorants; shoe deodorizers; toilet deodorants.

Application Number 2,068,197
Language of Application English

Filing Date 2020-12-02

APPLICANT DETAILS

Applicant

Shenzhen Yafei Electronic Commerce Co. LTD
Building 1401, Building 11, Tianan Yungu
Industrial Park Phase II (Lot 02-08)
Gangtou Community, Bantian Street,
Longgang District
Shenzhen, Guangdong,
CHINA

TRADEMARK DETAILS

Trademark Type

Design

Visual Representation



Goods

Class 25

children's clothing; coats; crop tops; dress clothing; gloves; hats; knit tops; masquerade costumes; pants; shoes; socks; sweaters; swimming costumes; undergarments; waist belts

Application Number 2,068,428
Language of Application English

Filing Date 2020-12-03

APPLICANT AND AGENT DETAILS

Applicant

Netflix Studios, LLC
5808 W. Sunset Blvd.
Los Angeles, CA 90028
UNITED STATES OF AMERICA

Agent

CLARK WILSON LLP
900 - 885 WEST GEORGIA STREET,
VANCOUVER, BRITISH COLUMBIA, V6C3H1

TRADEMARK DETAILS

WAFFLES & MOCHI

Trademark Type

Standard Characters

Services

Class 41

Entertainment services in the nature of a comedic drama television series; providing online non-downloadable video clips and multimedia entertainment recordings containing audio files, video files, artwork, and informational text from and related to a comedic drama television series

Claims

Priority Filing Date: June 05, 2020, Country or Office: JAMAICA, Application No: 80569 in association with the same kind of services

Application Number 2,070,887
Language of Application English

Filing Date 2020-12-14

APPLICANT AND AGENT DETAILS

Applicant

K Vintners, L.L.C.
820 Mill Creek Road
Walla Walla, WA 99362
UNITED STATES OF AMERICA

Agent

CLARK WILSON LLP
900 - 885 WEST GEORGIA STREET,
VANCOUVER, BRITISH COLUMBIA, V6C3H1

TRADEMARK DETAILS

K VINE

Trademark Type

Standard Characters

Goods

Class 33

Wines

Claims

Priority Filing Date: June 17, 2020, Country or Office: UNITED STATES OF AMERICA, Application No: 90/007,193 in association with the same kind of goods

Application Number 2,071,324
Language of Application English

Filing Date 2020-12-16

APPLICANT AND AGENT DETAILS

Applicant

CONSORTIUM FOR COMMON FOOD
NAMES HOLDINGS INC.
2107 WILSON BLVD, SUITE 600
ARLINGTON, VA 22201
UNITED STATES OF AMERICA

Agent

RICHARDS BUELL SUTTON LLP
Suite 700-401 West Georgia Street,
Vancouver, BRITISH COLUMBIA, V6B5A1

TRADEMARK DETAILS

Trademark Type

Design

Visual Representation



Goods

Class 29

Cheese;

Application Number 2,071,329
Language of Application English

Filing Date 2020-12-16

APPLICANT AND AGENT DETAILS

Applicant

CONSORTIUM FOR COMMON FOOD
NAMES HOLDINGS INC.
2107 WILSON BLVD, SUITE 600
ARLINGTON, VA 22201
UNITED STATES OF AMERICA

Agent

RICHARDS BUELL SUTTON LLP
Suite 700-401 West Georgia Street,
Vancouver, BRITISH COLUMBIA, V6B5A1

TRADEMARK DETAILS

Trademark Type

Design

Visual Representation



Goods

Class 29

Cheese;

Application Number 2,071,756
International Registration Number 1469820A
Language of Application English

Filing Date 2020-11-17

APPLICANT AND AGENT DETAILS

Applicant

Nintendo of America Inc.
4600 150th Avenue NE
Redmond WA 98052
UNITED STATES OF AMERICA

Agent

SMART & BIGGAR LLP
2300 - 1055 West Georgia Street, P.O. Box
11115, Vancouver, BRITISH COLUMBIA,
V6E3P3

TRADEMARK DETAILS

SUPER MARIO

Trademark Type

Standard Characters

Goods

Class 09

(1) Recorded electronic game programs; downloadable electronic game programs; recorded video game programs; downloadable video game programs; video game cartridges; cases for smartphones; covers for smartphones; covers for tablet computers; laptop sleeves; blank integrated circuit cards; mouse pads; recorded computer game software; downloadable computer game software; downloadable image files containing artwork, text, audio, videos relating to video games; downloadable music files; downloadable electronic publications, namely fiction stories, booklets, manuals and newsletters in the field of video games; headphones; electric batteries for home video game machines; eyeglasses; sunglasses.

Class 14

(2) Key rings; key chains; charms for key rings; jewelry boxes; coins; earrings; tie pins; medals; ornamental pins; jewelry; jewelry charms; shoe jewelry; watches; clocks; watch bands.

Class 16

(3) Stencils; paper bags and sacks; wrapping paper; place mats of paper; coasters of paper; table napkins of paper; paper towels; tablecloths of paper; writing stationery; notebooks; pencils; stickers; pen cases; rubber erasers; writing materials, namely pens; postcards; greeting cards; printed matter, namely calendars, children's activities books, magazines and manuals in the field of video games; books in the field of children's entertainment, fiction stories, and video games; computer game instruction manuals; posters; pictures; photograph stands; office requisites, namely stationery binders and file folders; pencil sharpeners.

Class 18

(4) Clothing for pets; collars for pets; bags, namely book bags, carry-on bags, shoulder bags, handbags, backpacks, drawstring pouches, travel bags, and luggage; school bags; rucksacks; suitcases; card cases; purses; wallets; key cases; luggage tags; garment bags for travel; bags for sports; unfitted vanity cases; umbrellas.

Class 21

(5) Hair brushes; brushes for washing up; combs for the hair; toothbrushes; floss for dental purposes; electric tooth brushes; cosmetic utensils, namely cosmetic brushes; toilet cases; fitted vanity cases; containers for household or kitchen use, namely beverage containers, food storage containers, pail containers, thermal insulated containers for food or beverages, drinking flasks, glass bowls, and soup bowls; utensils for kitchen and cleaning purposes, namely serving spoons, serving forks, and chopsticks; mugs; cups; dishes; plates; soup bowls; serving trays; lunch boxes; drinking bottles for sports; drinking straws; coasters, not of paper or textile, namely drink coasters; waste baskets; coin banks; soap holders.

Class 28

(6) Games, namely card games, promotional game cards, puzzles, trading card games; toys, namely toy balls, toy key chains, toy figures, water toys, plush toys, inflatable toys, party favors in the nature of small toys, toy balloons, toy building blocks, toy vehicle; stuffed toys; dolls; portable games with liquid crystal displays; protective films adapted for screens for portable games; video game machines; controllers for game consoles; arcade video game machines; board games; playing cards; protective carrying cases specially adapted for handheld video games; amusement park rides; ornaments for Christmas trees, except lights, candles and confectionery; paper party hats.

Class 29

(7) Milk products; yogurt; frozen fruits; jellies for food; jams; peanut butter.

Class 30

(8) Tea; tea-based beverages; coffee; coffee-based beverages; cocoa; cocoa-based beverages; sugar confectionery; candies; ice cream; cookies; chocolate; popcorn; chewing gum; bread and buns; sandwiches; pizzas; pies; cakes; pancakes; frozen yogurt; crackers; mints for breath freshening; seasonings; ketchup; dressings for salad; cereal preparations, namely oatmeal, corn flakes, breakfast cereals, cereal-based snack foods, and cereal bars; oatmeal; corn flakes; noodles; pasta sauce.

Class 32

(9) Soft drinks; fruit juice; vegetable juices; cola beverages; carbonated water; table waters.

Services

Class 41

Entertainment services, namely providing non-downloadable images featuring images of characters and scenes from an electronic game via a global computer network and wireless networks; entertainment services, namely providing non-downloadable prerecorded music and sounds in the field of video games, all on-line via a global computer network; entertainment services, namely providing temporary use of non-downloadable video games; providing entertainment information on video games and related video gaming products; providing non-downloadable online electronic publications namely, online journals and interactive online blogs featuring user generated or specified content in the field of video games and online publication of electronic books and magazines; providing non-downloadable online videos featuring video games via the Internet; providing non-downloadable music via the Internet; providing online video gaming services; organization of electronic game competitions for entertainment purposes; providing amusement arcade services.

Application Number 2,073,500
International Registration Number 1566563
Language of Application English

Filing Date 2020-10-26

APPLICANT AND AGENT DETAILS

Applicant

PHARMA COSMETICS LABORATORIES LTD.
4 Nirim Street
6706041 Tel-Aviv
ISRAEL

Agent

WENDY D. RIEL
(RIEL PROFESSIONAL CORPORATION), c/o
MDK Business Law Professional Corporation,
441 MacLaren Street, Suite 200B, Ottawa,
ONTARIO, K2P2H3

TRADEMARK DETAILS

PERFECT TIME

Trademark Type

Standard Characters

Goods

Class 03

Facial soap, facial serums for cosmetic purposes, facial and skin creams, cosmetic creams, wrinkle-minimizing cosmetic preparations for topical facial use, cosmetic creams for firming facial skin and around eyes, cosmetic skin and facial masks.

Application Number 2,075,681
International Registration Number 1569898
Language of Application English

Filing Date 2020-09-03

APPLICANT AND AGENT DETAILS

Applicant

Elite IP Holdings, LLC
1600 N. Park Drive
Weston FL 33326
UNITED STATES OF AMERICA

Agent

WILSON LUE LLP
250 University Avenue, 5th Floor, Toronto,
ONTARIO, M5H3E5

TRADEMARK DETAILS

KILL SHOT

Trademark Type

Standard Characters

Goods

Class 05

(1) Dietary supplement drink mixes for general health and well-being; Dietary supplemental drinks for general health and well-being; Dietary and nutritional supplements for general health and well-being; Liquid nutritional supplement for general health and well-being; Nutritional supplement meal replacement bars to provide energy; Nutritional supplements for general health and well-being; Nutritional and dietary supplements for general health and well-being formed and packaged as bars; Powdered nutritional supplement drink mix for general health and well-being

Class 32

(2) Energy drinks; isotonic drinks; non-alcoholic drinks, namely, energy shots; sports drinks.

Claims

Priority Filing Date: April 16, 2020, Country or Office: UNITED STATES OF AMERICA, Application No: 88875480 in association with the same kind of goods

Application Number 2,076,149
Language of Application English

Filing Date 2021-01-07

APPLICANT AND AGENT DETAILS

Applicant

SHENZHEN CHUJIN NETWORK
TECHNOLOGY CO.,LTD
301(305), Bldg 3, TOD Tech Center, Lipu Rd 7
Dafapushequ, Bantian St., Longgang Dist.
shenzhen,
CHINA

Agent

XIN XU
(JONES & CO.), 67 Yonge Street, Suite 602,
TORONTO, ONTARIO, M5E1J8

TRADEMARK DETAILS

Bediffer

Trademark Type

Standard Characters

Goods

Class 12

anti-skid chains for vehicle tires; anti-skid studs for vehicle tires; anti-theft alarms for vehicles; anti-theft devices for motor cars; automotive shock absorbing springs; barges; boats; brake linings for vehicles; brakes for vehicles; canoes; davits for boats; direction signals for vehicles; disengaging gear for boats; doors for vehicles; horns for motor vehicles; hubs for vehicle wheels; luggage carriers for vehicles; luggage nets for vehicles; masts for boats; motorboats; oars; paddles for canoes; rowlocks; rudders for vessels; seat covers for vehicles; ships; sleeping berths for vehicles; stern oars; valves for vehicle tires; vehicle seats; wheels of automobiles; windscreen wipers; windscreens; yachts

Application Number 2,076,152
Language of Application English

Filing Date 2021-01-07

APPLICANT AND AGENT DETAILS

Applicant

SHENZHEN CHUJIN NETWORK
TECHNOLOGY CO.,LTD
301(305), Bldg 3, TOD Tech Center, Lipu Rd 7
Dafapushequ, Bantian St., Longgang Dist.
shenzhen,
CHINA

Agent

XIN XU
(JONES & CO.), 67 Yonge Street, Suite 602,
TORONTO, ONTARIO, M5E1J8

TRADEMARK DETAILS

Kadimendium

Trademark Type

Standard Characters

Goods

Class 07

abrasive discs for power operated grinders; adhesive bands for pulleys; aerated beverage making machines; air drills; air filters for automobile engines; anti-pollution catalytic converters for motors and engines; ball rings for bearings; ball valves being parts of machines; belts for farm vehicle machines; blowing machines for the compression, exhaustion and transport of gases; bobbins for sewing machines; carburettors; centering drilling bits being parts of machines; centrifuges; chucks for power drills; compressed air pumps; cone brakes being parts of machines; electric door closer; electric door openers; engines and motors for the generation of electricity; machine bearings; machine bellows; membrane filters for use as parts of machines; pneumatic hammers; pneumatic nail guns; reciprocating vacuum pumps

Application Number 2,076,374
Language of Application English

Filing Date 2021-01-07

APPLICANT AND AGENT DETAILS

Applicant

SHENZHEN CHUJIN NETWORK
TECHNOLOGY CO.,LTD
301(305), Bldg 3, TOD Tech Center, Lipu Rd 7
Dafapushequ, Bantian St., Longgang Dist.
shenzhen,
CHINA

Agent

XIN XU
(JONES & CO.), 67 Yonge Street, Suite 602,
TORONTO, ONTARIO, M5E1J8

TRADEMARK DETAILS

DAUERHAFT

Trademark Type

Standard Characters

Goods

Class 09

anti-intrusion alarms; audio-video receivers; bags for cameras and photographic equipment; cameras; car video recorders; computer memory expansion modules; computer monitors; electric door bells; electronic burglar alarms; emergency signal transmitters; fingerprint door locks; flashing safety lights for traffic cones; magnifying peepholes for doors; megaphones; microphones; personal headphones for use with sound transmitting systems; photographic racks; push buttons for bells; reflective safety vests; selfie stick; shoes for protection against accidents, irradiation and fire; speaking tubes; video telephones; webcams

Application Number 2,076,375
Language of Application English

Filing Date 2021-01-07

APPLICANT AND AGENT DETAILS

Applicant

SHENZHEN CHUJIN NETWORK
TECHNOLOGY CO.,LTD
301(305), Bldg 3, TOD Tech Center, Lipu Rd 7
Dafapushequ, Bantian St., Longgang Dist.
shenzhen,
CHINA

Agent

XIN XU
(JONES & CO.), 67 Yonge Street, Suite 602,
TORONTO, ONTARIO, M5E1J8

TRADEMARK DETAILS

FOLOSAFENAR

Trademark Type

Standard Characters

Goods

Class 09

anti-intrusion alarms; audio-video receivers; bags for cameras and photographic equipment; cameras; car video recorders; computer memory expansion modules; computer monitors; electric door bells; electronic burglar alarms; emergency signal transmitters; fingerprint door locks; flashing safety lights for traffic cones; magnifying peepholes for doors; megaphones; microphones; personal headphones for use with sound transmitting systems; photographic racks; push buttons for bells; reflective safety vests; selfie stick; shoes for protection against accidents, irradiation and fire; speaking tubes; video telephones; webcams

Application Number 2,076,391
Language of Application English

Filing Date 2021-01-08

APPLICANT AND AGENT DETAILS

Applicant

SHENZHEN CHUJIN NETWORK
TECHNOLOGY CO.,LTD
301(305), Bldg 3, TOD Tech Center, Lipu Rd 7
Dafapushequ, Bantian St., Longgang Dist.
shenzhen,
CHINA

Agent

XIN XU
(JONES & CO.), 67 Yonge Street, Suite 602,
TORONTO, ONTARIO, M5E1J8

TRADEMARK DETAILS

Fybida

Trademark Type

Standard Characters

Goods

Class 03

baby powder; beard dyes; cosmetic cotton wool; cosmetics for animals; dental bleaching gel; deodorant soap; depilatories; eyebrow cosmetics; eyebrow pencils; facial cleansing milk; false nails; hair conditioner; hair lotions; hair tonics; jasmine oil; laundry stain removers; lip cream; lip glosses; mascaras; mustache wax; nail varnish; perfumes; polishing paper; scented wood; skin whitening creams; soda lye; sunscreen preparations; tissues impregnated with cosmetic lotions; vanilla perfumery

Application Number 2,076,395
Language of Application English

Filing Date 2021-01-08

APPLICANT AND AGENT DETAILS

Applicant

SHENZHEN CHUJIN NETWORK
TECHNOLOGY CO.,LTD
301(305), Bldg 3, TOD Tech Center, Lipu Rd 7
Dafapushequ, Bantian St., Longgang Dist.
shenzhen,
CHINA

Agent

XIN XU
(JONES & CO.), 67 Yonge Street, Suite 602,
TORONTO, ONTARIO, M5E1J8

TRADEMARK DETAILS

Jeanoko

Trademark Type

Standard Characters

Goods

Class 09

acidimeters for batteries; alidades; ammeters; anemometers; audio-video receivers; barometers; biometric hand scanners; cabinets for loudspeakers; calipers; carpenters' rules; chronographs for use as specialized time recording apparatus; computer hardware; computer interface boards; computer interface cards; electronic card readers; electronic control gears [ECGs] for LED lamps and light fixtures; electronic scoreboards; horns for loudspeakers; loud speakers; measuring cups; measuring rules; megaphones; micrometers; parking meters; screw-tapping gauges; slide calipers; styli for record players; surveying instruments; tyre-pressure measurers; USB card readers

Application Number 2,076,411
Language of Application English

Filing Date 2021-01-08

APPLICANT AND AGENT DETAILS

Applicant

SHENZHEN CHUJIN NETWORK
TECHNOLOGY CO.,LTD
301(305), Bldg 3, TOD Tech Center, Lipu Rd 7
Dafapushequ, Bantian St., Longgang Dist.
shenzhen,
CHINA

Agent

XIN XU
(JONES & CO.), 67 Yonge Street, Suite 602,
TORONTO, ONTARIO, M5E1J8

TRADEMARK DETAILS

KUIDAMOS

Trademark Type

Standard Characters

Goods

Class 20

baby changing mats; baby changing platforms; beds; beds for household pets; booster seats; bottle racks; clothes hangers; costume stands; cots; cots for babies; cradles; cupboards; dog kennels; fodder racks; folding seats; garden furniture; hat stands; high chairs for babies; infant walkers; inflatable furniture; kennels for household pets; kitchen furniture; lawn furniture; living room furniture; mats for infant playpens; mattresses; moses baskets; nesting boxes for animals; nesting boxes for household pets; office furniture; outdoor furniture; pet cushions; playpens for babies; scratching posts for cats; shower seats; writing desks

Application Number 2,080,482
International Registration Number 1572454
Language of Application English

Filing Date 2020-12-14

APPLICANT AND AGENT DETAILS

Applicant

LIBERTY PROCUREMENT CO. INC.
650 Liberty Avenue
Union NJ 07083
UNITED STATES OF AMERICA

Agent

GOWLING WLG (CANADA) LLP
1 MAIN STREET WEST, HAMILTON,
ONTARIO, L8P4Z5

TRADEMARK DETAILS

H FOR HAPPY

Trademark Type

Standard Characters

Goods

Class 03

(1) Air fragrance reed diffusers; non-medicated liquid soap; hand lotions; scented oils.

Class 05

(2) Antibacterial soap.

Class 09

(3) Measuring cups.

Class 21

(4) Canister sets; drinking straws; salt and pepper shakers; spoon rests; silicone cupcake baking liners; pot holders; cookie cutters.

Class 28

(5) Balloons.

Services

Class 35

Retail store services and on-line retail store services featuring a wide variety of consumer goods of others.

Application Number 2,081,245
Language of Application English

Filing Date 2021-02-01

APPLICANT AND AGENT DETAILS

Applicant

Market Track, LLC
24 E Washington St Ste 1200
Chicago, IL 60602-1757
UNITED STATES OF AMERICA

Agent

SMART & BIGGAR LLP
1100-150 York street, TORONTO, ONTARIO,
M5H3S5

TRADEMARK DETAILS

OMNISHARE

Trademark Type

Standard Characters

Goods

Class 09

Computer application software for mobile phones, handheld computers and tablets, namely, software for database management, providing a database and an on-line database in the field of transaction processing to upload transaction data, provide statistical analysis, and produce notifications and reports; Computer software for application and database integration, creating searchable databases of information and data, evaluating the effectiveness of advertisements in retailer circulars, the collection, editing, organizing, modifying, book marking, transmission, storage and sharing of data and information, and for researching sales and advertising trends and advertising effectiveness; Database management software for market assessment, analysis of market and marketing research data and statistics: Downloadable computer software that provides real-time, integrated business management intelligence by combining information from various databases and presenting it in an easy-to-understand user interface: Generating market reports and studies, conducting business market and marketing research, tracking consumer behavior and consumer trend analysis, tracking and reporting of retailer advertisements

Services

Class 35

(1) Advice and information about customer services and product management and prices on internet sites in connection with purchases made over the internet; Analysis of market and marketing research data and statistics; Analyzing and compiling business data; Business consultancy services, namely, competitive business analysis and monitoring of competitors' sales activities at all levels of distribution; Business consulting and information services in the field of business intelligence; Business information management; Business research and data analysis services in the field of retailing; Business research services, namely, tracking competitive advertising for others; Business services, namely, administration of a program for providing business intelligence services; Management and compilation of computerized databases; Systemization of information into computer databases; Collection of market and marketing research information; Compilation of statistics; Analysis of market research data and statistics; Statistical analysis and reporting services for business purposes; Computerized market and marketing research services; Conducting business and market and marketing research surveys

and studies for others; Consulting in the nature of analyzing and reporting sales activities at all levels of distribution; Consumer market and marketing research and consulting related thereto; Market and marketing analysis and research services; Market and marketing assessment services; Market and marketing reports and studies; Market and marketing research and business analyses, namely, business management analysis, business profit analysis, and strategic business analysis; Market and marketing research and market and marketing intelligence services; Market and marketing research by means of a computer database; Market and marketing research consultation, services and studies; Market and marketing segmentation consultation; Market and marketing study and analysis of market and marketing studies; Marketing and consulting services in the field of promoting and tracking the goods, services, and brands of others through all public communication means and/or in the field of conducting consumer tracking behavior research, consumer trend analysis and consumer market and marketing research; Online business research services that allow users to obtain market and marketing data, analysis, and reports; Preparation of business reports; Promoting, advertising and marketing the online databases and electronic publications of others; Providing an on-line computer database in the field of locating products, describing products, rating products, pricing products and comparing prices of products; Providing business, market and marketing intelligence services; Providing data analytics and business intelligence for marketing and management purposes; Providing market and marketing research services for others in the form of tracking and reporting advertisements placed by retailers in print, radio and television and on the internet in various markets; Providing pricing information about the goods and services of others via the global computer network; Providing market and marketing research information and market and marketing reports; Statistical analysis and reporting services for business purposes; Statistical evaluations of market and marketing data

Class 42

(2) Brand protection services, namely, anti-counterfeiting consulting in the fields of brand monitoring and protection, to protect against counterfeiting, tampering, and diversion, and to ensure the integrity of genuine products and documents; Data mining services in the fields of price information and market availability, electronic data storage; Online computer services, namely, providing a search engine for obtaining information and data relating to intellectual property abuse and seller advertising violations from websites on a global computer network; Providing temporary use of on-line non-downloadable software for data analysis in the field of retailing and for researching sales and advertising trends and advertising effectiveness via a website; Providing online non-downloadable Internet-based system application featuring technology enabling users to research, analyze, and generate reports related to consumer market and marketing data; Providing online nondownloadable software for information and data collection, measurement, analytics and manipulation in the fields of market research, marketing research, market intelligence, marketing intelligence, business intelligence, business analytics and business reporting and for market research, marketing research and business intelligence; Providing software as a service (SAAS) featuring software for providing business, market and marketing analytics, competitive business analysis, information management, data management, information integration, business intelligence functions, monitoring, analyzing, and reporting on information available about other companies for business purposes, for analyzing business data for purposes of business intelligence analytics and reporting, for data analysis in the field of retail, and for the visual and analytic review of promotional, brand and e-commerce activity in a variety of media types in the field of market and marketing research; Providing software research tool, namely, research in the field of software design; Providing temporary use of non-downloadable computer software for evaluating the effectiveness of all individual ad blocks within each retailer circular; Web based programs that provide business intelligence, namely, providing temporary use of online

non-downloadable software to search and analyze promotional advertising information and associated reports and graphs; Providing temporary use of web-based software application and user interface that provides real-time product information; Data feeds and API data integration tools, namely, computer systems integration services used to provide data sets to integrate with third party systems and client specific databases and software; Services, namely, providing temporary use of online software applications that alert and provide insights for new product introductions and product lifecycle stages within the retail marketplace; Services, namely, providing temporary use of online software applications that provide recommendations and workflow and action management tools in areas, namely, adding products to a retailer's assortment, purchasing and placing advertising/media and search engine optimization within retailer sites; Services, namely, providing temporary use of online software that provides data and market estimates for sales-share and consumer demand across online retailers and for omni-channel; Services, namely, providing temporary use of online software for retailers to manage promotional advertising requests, approvals, placement, and production workflows from their brand supplier partners; Services, namely, providing temporary use of online software applications that incorporate consumer viewing habits and provide media targeting and advertising services to measure impact of advertising campaigns; Services, namely, providing temporary use of online software applications that analyze consumer behavioral data and create prediction methods and engines that forecast or predict consumer behavior or impact; Providing temporary use of web based programs that provide business intelligence, namely, providing an online computer database in the field of promotional advertising information and associated reports and graphs; Web based subscription to online non-downloadable software that allows users access to retail product and price intelligence

Claims

Priority Filing Date: November 24, 2020, Country or Office: UNITED STATES OF AMERICA, Application No: 90340378 in association with the same kind of goods and in association with the same kind of services

Application Number 2,081,260
Language of Application English

Filing Date 2021-02-01

APPLICANT AND AGENT DETAILS

Applicant

Market Track, LLC
24 E Washington St Ste 1200
Chicago, IL 60602-1757
UNITED STATES OF AMERICA

Agent

SMART & BIGGAR LLP
1100-150 York street, TORONTO, ONTARIO,
M5H3S5

TRADEMARK DETAILS

OMNISPEND

Trademark Type

Standard Characters

Goods

Class 09

Computer application software for mobile phones, handheld computers and tablets, namely, software for database management, providing a database and an on-line database in the field of transaction processing to upload transaction data, provide statistical analysis, and produce notifications and reports; Computer software for application and database integration, creating searchable databases of information and data, evaluating the effectiveness of advertisements in retailer circulars, the collection, editing, organizing, modifying, book marking, transmission, storage and sharing of data and information, and for researching sales and advertising trends and advertising effectiveness; Database management software for market assessment, analysis of market and marketing research data and statistics: Downloadable computer software that provides real-time, integrated business management intelligence by combining information from various databases and presenting it in an easy-to-understand user interface: Generating market reports and studies, conducting business market and marketing research, tracking consumer behavior and consumer trend analysis, tracking and reporting of retailer advertisements

Services

Class 35

(1) Advice and information about customer services and product management and prices on internet sites in connection with purchases made over the internet; Analysis of market and marketing research data and statistics; Analyzing and compiling business data; Business consultancy services, namely, competitive business analysis and monitoring of competitors' sales activities at all levels of distribution; Business consulting and information services in the field of business intelligence; Business information management; Business research and data analysis services in the field of retailing; Business research services, namely, tracking competitive advertising for others; Business services, namely, administration of a program for providing business intelligence services; Management and compilation of computerized databases; Systemization of information into computer databases; Collection of market and marketing research information; Compilation of statistics; Analysis of market research data and statistics; Statistical analysis and reporting services for business purposes; Computerized market and marketing research services; Conducting business and market and marketing research surveys

and studies for others; Consulting in the nature of analyzing and reporting sales activities at all levels of distribution; Consumer market and marketing research and consulting related thereto; Market and marketing analysis and research services; Market and marketing assessment services; Market and marketing reports and studies; Market and marketing research and business analyses, namely, business management analysis, business profit analysis, and strategic business analysis; Market and marketing research and market and marketing intelligence services; Market and marketing research by means of a computer database; Market and marketing research consultation, services and studies; Market and marketing segmentation consultation; Market and marketing study and analysis of market and marketing studies; Marketing and consulting services in the field of promoting and tracking the goods, services, and brands of others through all public communication means and/or in the field of conducting consumer tracking behavior research, consumer trend analysis and consumer market and marketing research; Online business research services that allow users to obtain market and marketing data, analysis, and reports; Preparation of business reports; Promoting, advertising and marketing the online databases and electronic publications of others; Providing an on-line computer database in the field of locating products, describing products, rating products, pricing products and comparing prices of products; Providing business, market and marketing intelligence services; Providing data analytics and business intelligence for marketing and management purposes; Providing market and marketing research services for others in the form of tracking and reporting advertisements placed by retailers in print, radio and television and on the internet in various markets; Providing pricing information about the goods and services of others via the global computer network; Providing market and marketing research information and market and marketing reports; Statistical analysis and reporting services for business purposes; Statistical evaluations of market and marketing data

Class 42

(2) Brand protection services, namely, anti-counterfeiting consulting in the fields of brand monitoring and protection, to protect against counterfeiting, tampering, and diversion, and to ensure the integrity of genuine products and documents; Data mining services in the fields of price information and market availability, electronic data storage; Online computer services, namely, providing a search engine for obtaining information and data relating to intellectual property abuse and seller advertising violations from websites on a global computer network; Providing temporary use of on-line non-downloadable software for data analysis in the field of retailing and for researching sales and advertising trends and advertising effectiveness via a website; Providing online non-downloadable Internet-based system application featuring technology enabling users to research, analyze, and generate reports related to consumer market and marketing data; Providing online nondownloadable software for information and data collection, measurement, analytics and manipulation in the fields of market research, marketing research, market intelligence, marketing intelligence, business intelligence, business analytics and business reporting and for market research, marketing research and business intelligence; Providing software as a service (SAAS) featuring software for providing business, market and marketing analytics, competitive business analysis, information management, data management, information integration, business intelligence functions, monitoring, analyzing, and reporting on information available about other companies for business purposes, for analyzing business data for purposes of business intelligence analytics and reporting, for data analysis in the field of retail, and for the visual and analytic review of promotional, brand and e-commerce activity in a variety of media types in the field of market and marketing research; Providing software research tool, namely, research in the field of software design; Providing temporary use of non-downloadable computer software for evaluating the effectiveness of all individual ad blocks within each retailer circular; Web based programs that provide business intelligence, namely, providing temporary use of online

non-downloadable software to search and analyze promotional advertising information and associated reports and graphs; Providing temporary use of web-based software application and user interface that provides real-time product information; Data feeds and API data integration tools, namely, computer systems integration services used to provide data sets to integrate with third party systems and client specific databases and software; Services, namely, providing temporary use of online software applications that alert and provide insights for new product introductions and product lifecycle stages within the retail marketplace; Services, namely, providing temporary use of online software applications that provide recommendations and workflow and action management tools in areas, namely, adding products to a retailer's assortment, purchasing and placing advertising/media and search engine optimization within retailer sites; Services, namely, providing temporary use of online software that provides data and market estimates for sales-share and consumer demand across online retailers and for omni-channel; Services, namely, providing temporary use of online software for retailers to manage promotional advertising requests, approvals, placement, and production workflows from their brand supplier partners; Services, namely, providing temporary use of online software applications that incorporate consumer viewing habits and provide media targeting and advertising services to measure impact of advertising campaigns; Services, namely, providing temporary use of online software applications that analyze consumer behavioral data and create prediction methods and engines that forecast or predict consumer behavior or impact; Providing temporary use of web based programs that provide business intelligence, namely, providing an online computer database in the field of promotional advertising information and associated reports and graphs; Web based subscription to online non-downloadable software that allows users access to retail product and price intelligence

Claims

Priority Filing Date: November 24, 2020, Country or Office: UNITED STATES OF AMERICA, Application No: 90340358 in association with the same kind of goods and in association with the same kind of services

Application Number 2,081,459
Language of Application English

Filing Date 2021-02-02

APPLICANT DETAILS

Applicant

Emendeez LLC
501 Silverside Road
Suite 102
Wilmington, DE 19809
UNITED STATES OF AMERICA

TRADEMARK DETAILS

Trademark Type

Design

Visual Representation



Goods

Class 24

bed sheets; comforters; duvet covers

Claims

Priority Filing Date: December 29, 2020, Country or Office: UNITED STATES OF AMERICA,
Application No: 90424860 in association with the same kind of goods

Application Number 2,082,388
Language of Application English

Filing Date 2021-02-03

APPLICANT AND AGENT DETAILS

Applicant

Yufen Zhou
No. 84, Xinguang Village, Meitang Town
Puning City, Guangdong, 515342
CHINA

Agent

JERRY CHEN
166 Berwick Cres, Richmond Hill, ONTARIO,
L4C0B4

TRADEMARK DETAILS

KIPBELIF

Trademark Type

Standard Characters

Goods

Class 18

All-purpose carrying bags; bags for carrying animals; backpacks; book bags; sports bags; bum bags; wallets; Handbags; beach bags; canvas bags for shopping; clutch purses; cosmetic bags sold empty; daypacks; flight bags; gym bags; kit bags; compression cubes adapted for luggage; make-up bags sold empty; overnight bags; key pouches; rucksacks; toiletry bags sold empty; travel bags; wash bags for carrying toiletries

Application Number 2,082,586
Language of Application English

Filing Date 2021-02-04

APPLICANT AND AGENT DETAILS

Applicant

LG Household & Health Care Ltd.
58, Saemunan-ro, Jongno-gu
Seoul, 03184
REPUBLIC OF KOREA

Agent

BORDEN LADNER GERVAIS LLP
World Exchange Plaza, 100 Queen Street,
Suite 1300, Ottawa, ONTARIO, K1P1J9

TRADEMARK DETAILS

Trademark Type

Design

Visual Representation



Goods

Class 03

Cosmetics; skin milk lotions; perfumes; colognes; eau de toilette; body mist; perfumes in solid form; perfumed soap; perfumed powder; fragrances for personal use; cosmetic cleansing creams; bath soaps; lipsticks; shampoos; eye shadows; dentifrices; hair rinses; hair essence namely, perfumed oils for hair; sunscreen lotions; foundation creams; cheek blush; eye liner; nail polish; cosmetic skin nourishing creams; mask pack for cosmetic purposes; cosmetic body care soaps; lip gloss; massage cream; body lotions; bath gels; shower gels; massage oil; enamel for nails; varnish-removing preparations; cosmetic bath powder; perfumed powder for personal use; hair lotions; body creams; skin cleansing foams; skin cleansing lotions; body cleanser; sun care preparations; nail care preparations; hair care preparations; skin care preparations; body care preparations, namely, body and beauty care cosmetics

Application Number 2,089,073
International Registration Number 1579080
Language of Application French

Filing Date 2020-12-31

APPLICANT DETAILS

Applicant
L'OREAL
14 rue Royale
F-75008 Paris
FRANCE

TRADEMARK DETAILS

DREAM IT, LOVE IT, REFILL IT

Trademark Type
Standard Characters

Goods

Class 03

Makeup.

Services

Class 44

Hygiene and beauty care information and advisory services provided to consumers for the selection of cosmetic products, beauty products and makeup products.

Claims

Priority Filing Date: July 01, 2020, Country or Office: FRANCE, Application No: 4662342 in association with the same kind of goods and in association with the same kind of services

Application Number 2,089,075
International Registration Number 1579386
Language of Application English

Filing Date 2020-12-31

APPLICANT DETAILS

Applicant

Riton USA, LLC
1025 N. Huntington Park
Tucson AZ 85710
UNITED STATES OF AMERICA

TRADEMARK DETAILS

Trademark Type

Design

Visual Representation



Trademark Description

The mark consists of a shield outline with the left side formed by a stylized "R", and with the right side of the letter formed by a curved line that protrudes in the middle of the shield.

Goods

Class 09

(1) Telescopic riflescopes; spotting scopes; binoculars; range finders for use with firearms; laser pointing devices for use with firearms; game cameras.

Class 13

(2) Non-telescopic gun sights for firearms.

Services

Class 35

On-line retail store services featuring hunting and outdoor gear, namely, telescopic riflescopes, spotting scopes, binoculars, range finders for use with firearms, laser pointing devices for use with firearms, game cameras, and non-telescopic gun sights for firearms.

Claims

Priority Filing Date: July 15, 2020, Country or Office: UNITED STATES OF AMERICA, Application No: 90054169 in association with the same kind of goods and in association with the same kind of services

Application Number 2,089,136
International Registration Number 1579074
Language of Application French

Filing Date 2021-01-12

APPLICANT DETAILS

Applicant
Medela Holding AG
Lättichstrasse 4b
CH-6340 Baar
SUISSE

TRADEMARK DETAILS

Trademark Type
Design

Visual Representation



Goods

Class 10

Breast pumps and parts thereof; breast pump membranes; breast pump valves; breast shields.

Claims

Priority Filing Date: September 29, 2020, Country or Office: SWITZERLAND, Application No: 757614 in association with the same kind of goods

Application Number 2,089,137
International Registration Number 1578891
Language of Application French

Filing Date 2021-01-12

APPLICANT DETAILS

Applicant
BORIE MANOUX
88 Quai de Bacalan
F-33300 BORDEAUX
FRANCE

TRADEMARK DETAILS

ORIGINS BORIE MANOUX

Trademark Type
Standard Characters

Goods

Class 33

Wines with the protected designations of origin from the Bordelais.

Application Number 2,089,170
International Registration Number 1579053
Language of Application French

Filing Date 2021-01-13

APPLICANT DETAILS

Applicant

Enduristan GmbH
Kirchgasse 23
CH-8472 Seuzach
SUISSE

TRADEMARK DETAILS

Enduristan

Trademark Type

Standard Characters

Goods

Class 12

(1) Special boxes for motorcycles.

Class 18

(2) Luggage.

Claims

Priority Filing Date: December 04, 2020, Country or Office: SWITZERLAND, Application No: 757654 in association with the same kind of goods

Application Number 2,089,177
International Registration Number 1579111
Language of Application English

Filing Date 2021-01-15

APPLICANT DETAILS

Applicant

Oberon Technologies, Inc.
2232 S. Main Street, Suite #454
Ann Arbor MI 48103
UNITED STATES OF AMERICA

TRADEMARK DETAILS

Trademark Type

Design

Visual Representation



Trademark Description

The mark consists of the stylized word "TITANIA" with a butterfly like design to the left of the word.

Services

Class 42

Software as a service (SaaS) services featuring enterprise content delivery software platform designed for the web portal delivery of enterprise digital content, namely, textual, graphical, video, extended reality (XR), virtual reality (VR), augmented reality (AR) and mixed reality (MR).

Claims

Priority Filing Date: July 17, 2020, Country or Office: UNITED STATES OF AMERICA, Application No: 90059271 in association with the same kind of services

Application Number 2,089,188
International Registration Number 1578791
Language of Application English

Filing Date 2021-01-17

APPLICANT DETAILS

Applicant

Lifetracks Events Pty Ltd
2 Gibson Road
Mosman NSW 2088
AUSTRALIA

TRADEMARK DETAILS

Trademark Type

Design

Visual Representation

MIXOPIA

Services

Class 41

Music arranging services; compilation of digital music based time based events and playlists in the nature of curating soundtracks for music playlists; organizing and conducting competitions providing digital music; music soundtrack compilation services in the nature of curating soundtracks for music playlists.

Application Number 2,089,195
International Registration Number 1578964
Language of Application English

Filing Date 2021-01-18

APPLICANT DETAILS

Applicant

Finsight Group Inc
530 7th Ave, 27th Fl
New York NY 10018
UNITED STATES OF AMERICA

TRADEMARK DETAILS

Verisend

Trademark Type

Standard Characters

Services

Class 42

File sharing services, namely, providing a website featuring technology enabling users to upload and download electronic files.

Application Number 2,090,871
International Registration Number 1579714
Language of Application English

Filing Date 2020-12-23

APPLICANT DETAILS

Applicant

LegalZoom.com, Inc.
101 N. Brand Blvd., 11th Floor
Glendale CA 91203
UNITED STATES OF AMERICA

TRADEMARK DETAILS

Trademark Type

Design

Visual Representation



Trademark Description

The mark consists of the stylized capital letter "L" overlapping the letter "Z" with shading to emphasize the letters "L" and "Z" to the left of the word LEGALZOOM.

Services

Class 45

Legal services; legal document preparation services and providing general legal information via a website on global computer networks; providing general legal information via a website on global computer networks and via attorney consultation.

Claims

Priority Filing Date: June 29, 2020, Country or Office: UNITED STATES OF AMERICA, Application No: 90025351 in association with the same kind of services

Application Number 2,090,938
International Registration Number 1579943
Language of Application English

Filing Date 2021-01-08

APPLICANT DETAILS

Applicant

Glaxo Group Limited
980 Great West Road
Brentford, Middlesex TW8 9GS
UNITED KINGDOM

TRADEMARK DETAILS

RILZOVA

Trademark Type

Standard Characters

Goods

Class 05

Pharmaceutical preparations for use as anti-infectives; pharmaceutical preparations for the treatment of viral conditions, namely human immunodeficiency virus (hiv), human papilloma virus, respiratory syncytial virus, hepatitis, herpes genitalis, herpes labialis, herpes simplex virus, varicella-zoster virus, epstein-barr virus and cytomegalovirus; pharmaceutical preparations for the treatment and prevention of respiratory diseases and disorders and their symptoms; pharmaceutical preparations for the treatment of immune system related diseases and disorders, namely immunosuppressants; pharmaceutical preparations for the treatment of immunologic diseases and disorders namely, autoimmune diseases and disorders; pharmaceutical preparations for the treatment of atherosclerosis; pharmaceutical preparations for the treatment of viral conditions namely human immunodeficiency virus (hiv), hpv, rsv, hepatitis, herpes genitalis, herpes labialis, herpes simplex virus, varicella-zoster virus, epstein-barr virus and cytomegalovirus; pharmaceutical preparations for the treatment and prevention of metabolic related diseases and disorders namely disorders of the endocrine system, namely growth and thyroid disorders, diabetes, metabolic syndrome, obesity, weight loss and weight management; pharmaceutical preparations for the treatment and prevention of cardiovascular, cardiopulmonary, cardio-renal and renal diseases and disorders; pharmaceutical preparations for the prevention and treatment of oncological diseases and disorders; pharmaceutical preparations for the treatment of inflammation and inflammatory related diseases and disorders namely arthritis, rheumatoid arthritis, inflammatory bowel diseases, inflammatory connective tissue diseases, vasculitis, synovitis; pharmaceutical preparations for the prevention and treatment of sequelae of oncologic diseases and their treatment namely nausea and vomiting, hematologic depression, mucositis, cachexia, pain, bone pain and fatigue; pharmaceutical preparations for the treatment of blood-related diseases and disorders namely thrombocytopenia, coagulation disorders, bleeding disorders, platelet disorders, blood vessel disorders, sickle-cell disease and its related disorders, anemias, sepsis and infections in and of the blood; pharmaceutical preparations for the treatment of musculoskeletal diseases, disorders and injuries namely connective tissue diseases, bone diseases, osteoporosis, spinal diseases, back pain, gout, fractures, sprains, sports injuries,

osteogenesis imperfecta, muscle wasting (cachexia), renal osteodystrophy, cartilage injuries, joint replacement and osteoarthritis; pharmaceutical preparations for use in ophthalmology; pharmaceutical preparations for the treatment of dermatological diseases and disorders namely dermatitis, skin and skin structure infections namely bacterial skin infections, fungal skin infections, viral skin infections and parasitic skin infections, psoriasis, eczema and sexually transmitted diseases; pharmaceutical preparations for the treatment of hormonal related diseases and disorders namely hypogonadism, testosterone/androgen disorders and estrogen disorders; pharmaceutical preparations for the treatment of gastrointestinal related diseases and disorders namely irritable bowel disorders and symptoms, digestive disorders and acid-related disorders; pharmaceutical preparations for the treatment of sexual dysfunction namely erectile dysfunction, male and female sexual dysfunction disorders namely arousal disorder, pain disorder, desire disorder and orgasm disorder; pharmaceutical preparations for the treatment of genitourinary diseases namely urological diseases and disorders; pharmaceutical preparations for the treatment of gynaecological diseases and disorders namely amenorrhoea, dysmenorrhoea and infertility; pharmaceutical hormonal preparations namely corticosteroids, hormone replacement therapy preparations, oral contraceptives, thyroid hormone preparations; pharmaceutical preparations for the treatment of incontinence, prostate diseases and disorders, bladder diseases and disorders; pharmaceutical preparations for the treatment of sexually transmitted diseases, inflammatory pelvic diseases, vasomotor/menopausal symptoms, endometriosis/uterine fibroids, leiomyoma, endourology/stone, pre-eclampsia and pre-term labour; pharmaceutical preparations for the treatment of prostatitis, nephritis, cystitis, vaginitis, renal disease; pharmaceutical preparations for the treatment of premenstrual dysphoric disorder, premenstrual syndrome, male hypogonadism and hormonal disorders namely polycystic ovary syndrome; pharmaceutical preparations for the treatment of hepatological related diseases namely hepatitis, non-alcoholic fatty liver disease (nafld), non-alcoholic steatohepatitis (nash), liver fibroids, and cirrhosis; pharmaceutical preparations for the treatment of alopecia and androgenic alopecia (male pattern baldness); pharmaceutical preparations for the treatment of psychiatric diseases and disorders namely mood disorders, anxiety disorders, cognitive disorders, schizophrenia, and psychoses; pharmaceutical preparations for the treatment of damaged skin and tissue namely bee stings, sunburn, rashes, sores, corns, calluses and acne; pharmaceutical preparations for the treatment of inflammatory connective tissue diseases and injuries; pharmaceutical preparations for the treatment of malaria; pharmaceutical preparations for the treatment of tuberculosis; allergy medications; vaccines namely prophylactic and therapeutic vaccines for humans; pharmaceutical preparations for the treatment of neurological diseases and disorders namely parkinsons disease, alzheimers disease, huntingtons disease, dementia, migraine, cerebral palsy, brain injury, spinal cord injury, seizure disorders, epilepsy, restless legs syndrome, pain, neuropathic pain, inflammatory-related pain, fibromyalgia, stroke, multiple sclerosis, insomnia; pharmaceutical preparations for the treatment of central nervous system diseases and disorders namely central nervous system infections, brain diseases, central nervous system movement disorders, ocular motility disorders, spinal cord diseases, depression and anxiety and their related disorders namely schizophrenia and psychoses; pharmaceutical preparations for the treatment of muscular dystrophy.

Claims

Priority Filing Date: December 18, 2020, Country or Office: UNITED KINGDOM, Application No: UK00003569631 in association with the same kind of goods

Application Number 2,090,965
International Registration Number 1580427
Language of Application English

Filing Date 2021-01-12

APPLICANT DETAILS

Applicant
Walberg Urban Safehouse Holding GmbH
Alter Wandrahm 6
20457 Hamburg
GERMANY

TRADEMARK DETAILS

Captain Electric

Trademark Type
Standard Characters

Goods

Class 18

Luggage, handbags, backpacks, suitcases, wallets and carrying bags; leather and imitations of leather.

Claims

Priority Filing Date: November 17, 2020, Country or Office: GERMANY, Application No: 30 2020 025 165 in association with the same kind of goods

Application Number 2,090,995
International Registration Number 1579947
Language of Application English

Filing Date 2021-01-15

APPLICANT DETAILS

Applicant

Oberon Technologies, Inc.
2232 S. Main Street, Suite #454
Ann Arbor MI 48103
UNITED STATES OF AMERICA

TRADEMARK DETAILS

TITANIA

Trademark Type

Standard Characters

Services

Class 42

Software as a service (SaaS) services featuring enterprise content delivery software platform designed for the web portal delivery of enterprise digital content, namely, textual, graphical, video, extended reality (XR), virtual reality (VR), augmented reality (AR) and mixed reality (MR).

Claims

Priority Filing Date: July 17, 2020, Country or Office: UNITED STATES OF AMERICA, Application No: 90059268 in association with the same kind of services

Application Number 2,091,005
International Registration Number 1580068
Language of Application English

Filing Date 2020-04-01

APPLICANT DETAILS

Applicant

Smarfi s.r.l.

Via Giuseppe di Vagno 14/A

I-70017 Putignano (BA)

ITALY

TRADEMARK DETAILS

SMARFI

Trademark Type

Standard Characters

Services

Class 36

Financial planning; financial planning and investment advisory services; financial valuations; financial analysis; financial management.

Application Number 2,091,022
International Registration Number 1580178
Language of Application English

Filing Date 2021-01-19

APPLICANT AND AGENT DETAILS

Applicant

MAFCO Worldwide LLC
300 Jefferson Street
Camden NJ 08104
UNITED STATES OF AMERICA

Agent

BORDEN LADNER GERVAIS LLP
World Exchange Plaza, 100 Queen Street,
Suite 1300, Ottawa, ONTARIO, K1P1J9

TRADEMARK DETAILS

MAGNABOOST

Trademark Type

Standard Characters

Goods

Class 30

Flavorings, other than essential oils, namely salt flavor enhancers for food and beverage products.

Claims

Priority Filing Date: January 01, 2021, Country or Office: UNITED STATES OF AMERICA,
Application No: 90443888 in association with the same kind of goods

Application Number 2,091,070
International Registration Number 1579664
Language of Application English

Filing Date 2021-01-23

APPLICANT DETAILS

Applicant

Qualgear LLC
1500 Precision Drive
Suite 100 TX 75074
UNITED STATES OF AMERICA

TRADEMARK DETAILS

nextergo

Trademark Type

Standard Characters

Goods

Class 20

Chairs; desks; height adjustable tables; office desks; standing desks.

Application Number 2,091,071
International Registration Number 1580734
Language of Application English

Filing Date 2021-01-25

APPLICANT DETAILS

Applicant
TEE-2-GREEN CORPORATION
29975 S BARLOW RD
CANBY OR 97013
UNITED STATES OF AMERICA

TRADEMARK DETAILS

Trademark Type
Design

Visual Representation



Colour Claim

The color(s) black and green is/are claimed as a feature of the mark. The mark consists of the letters "Pd" with the letter "P" in black and letter "d" consisting of a half circle in black and blade of green grass.

Goods

Class 31

Grass seed.

Claims

Priority Filing Date: July 31, 2020, Country or Office: UNITED STATES OF AMERICA, Application No: 90087104 in association with the same kind of goods

Application Number 2,091,075
International Registration Number 1580361
Language of Application English

Filing Date 2021-01-25

APPLICANT DETAILS

Applicant
TEE-2-GREEN CORPORATION
29975 S Barlow Rd
Canby OR 97013
UNITED STATES OF AMERICA

TRADEMARK DETAILS

Trademark Type
Design

Visual Representation



Goods
Class 31
Grass seed.

Claims
Priority Filing Date: July 31, 2020, Country or Office: UNITED STATES OF AMERICA, Application No: 90087111 in association with the same kind of goods

Application Number 2,091,077
International Registration Number 1580110
Language of Application English

Filing Date 2021-01-25

APPLICANT AND AGENT DETAILS

Applicant

Polis Educational Solutions Inc.
One Mifflin Place, Suite 400
Cambridge MA 02138
UNITED STATES OF AMERICA

Agent

SUSANNAH ROLSTON
(GOWLING WLG (Canada) LLP), SUITE 1600,
1 FIRST CANADIAN PLACE, 100 KING
STREET WEST, TORONTO, ONTARIO,
M5X1G5

TRADEMARK DETAILS

POLIS

Trademark Type

Standard Characters

Goods

Class 09

Downloadable computer application software for mobile phones, namely, software for providing students online access to educators, tutoring, mentoring, academic advisory.

Services

Class 42

Software as a service (SAAS) services featuring software for providing students online access to educators, tutoring, mentoring, academic advisory, all via a website.

Claims

Priority Filing Date: July 23, 2020, Country or Office: UNITED STATES OF AMERICA, Application No: 90068940 in association with the same kind of goods and in association with the same kind of services

Application Number 2,091,088
International Registration Number 1580522
Language of Application English

Filing Date 2021-01-26

APPLICANT DETAILS

Applicant
CLICKRIGHT CONSULTING, LLC
41 Woodland St.
Natick MA 01760
UNITED STATES OF AMERICA

TRADEMARK DETAILS

PetnPurr

Trademark Type
Standard Characters

Goods

Class 20

(1) Cat scratching posts; beds for household pets.

Class 21

(2) Cat litter boxes; pet bowls; pet drinking bowls; pet feeding and drinking bowls.

Application Number 2,091,105
International Registration Number 1580372
Language of Application English

Filing Date 2021-01-27

APPLICANT AND AGENT DETAILS

Applicant

Custom Orchards, Inc.
One Oneonta Way
Wenatchee WA 98801
UNITED STATES OF AMERICA

Agent

JANINE A. MACNEIL
(Fasken Martineau DuMoulin LLP), 2900 - 550
Burrard Street, Vancouver, BRITISH
COLUMBIA, V6C0A3

TRADEMARK DETAILS

Trademark Type

Design

Visual Representation



Trademark Description

The mark consists of an apple, a leaf, and a curvy line through the apple to suggest the shape of yin and yang, followed by the word KARMA in stylized lower case letters.

Goods

Class 31

Fresh apples; raw apples; unprocessed apples.

Claims

Priority Filing Date: December 21, 2020, Country or Office: UNITED STATES OF AMERICA,
Application No: 90398349 in association with the same kind of goods

Application Number 2,091,168
International Registration Number 1579996
Language of Application English

Filing Date 2021-02-03

APPLICANT AND AGENT DETAILS

Applicant

YETI COOLERS, LLC
7601 Southwest Pkwy
Austin TX 78735
UNITED STATES OF AMERICA

Agent

CASSELS BROCK & BLACKWELL LLP
SCOTIA PLAZA, SUITE 2100, 40 KING
STREET WEST, TORONTO, ONTARIO,
M5H3C2

TRADEMARK DETAILS

YETI

Trademark Type

Standard Characters

Goods

Class 24

Sleeping bags.

Claims

Priority Filing Date: August 04, 2020, Country or Office: UNITED STATES OF AMERICA,
Application No: 90092391 in association with the same kind of goods

Application Number 2,092,075
Language of Application French

Filing Date 2021-03-16

APPLICANT AND AGENT DETAILS

Applicant

FROMAGERIE BERGERON INC.
3837 Rte Marie-Victorin
Saint-Antoine-de-Tilly
QUÉBEC
G0S2C0

Agent

STEPHANE LAMONDE
(O'BRIEN AVOCATS), 140 GRANDE-ALLEE
EST, BUREAU 600, QUEBEC, QUÉBEC,
G1R5M8

TRADEMARK DETAILS

Trademark Type

Design

Visual Representation



Colour Claim

Colour is claimed as a feature of the trademark. The arched rectangle with rounded edges containing the word FROMAGERIE and the cheese wheel with a portion cut out of it (1/4), both of which are contained in a black circle located at the top of the mark, are red (Pantone* PMS 186). The line around the edge of the black circle at the top of the mark containing the words FROMAGERIE BERGERON is yellow (Pantone* PMS 136). The circle in the upper half of the ellipse, and inside which is written the word PREMIUM, is yellow (Pantone* PMS 136). The words LOUIS CYR in the ellipse at the bottom of the mark are yellow (Pantone* PMS 136). The fine line at the outer edge of the circle bounding the mark is red (Pantone* PMS 186). The other elements, including the background and the lettering, are white or black (Pantone * PMS black). * Pantone is a registered trademark.

Disclaimer

The right to the exclusive use of the words "FROMAGE À PÂTE FERME AFFINÉ" and "RIPENED FIRM CHEESE" is disclaimed apart from the trademark.

Goods

Class 29
Cheeses.

Application Number 2,092,473
Language of Application English

Filing Date 2021-03-17

APPLICANT DETAILS

Applicant

YANG LI

5-5505 Rue De Chambery

Brossard

QUEBEC

J4Z0N8

TRADEMARK DETAILS

LeCASE

Trademark Type

Standard Characters

Services

Class 35

online sales of clothing; online sales of home entertainment electronics; online sales of housewares; online sales of sporting goods; online sales of toys

Application Number 2,092,557
International Registration Number 1581540
Language of Application English

Filing Date 2020-10-27

APPLICANT DETAILS

Applicant

Iscar Ltd.
P.O. Box 11
2495900 Tefen
ISRAEL

TRADEMARK DETAILS

JETCROWN

Trademark Type

Standard Characters

Goods

Class 07

Cutting tools for use with power operated machines, namely, cooling accessories for parting tools, grooving tools and turning tools.

Claims

Priority Filing Date: September 08, 2020, Country or Office: ISRAEL, Application No: 331250 in association with the same kind of goods

Application Number 2,092,563
International Registration Number 1581580
Language of Application English

Filing Date 2020-10-27

APPLICANT DETAILS

Applicant

Iscar Ltd.
P.O. Box 11
2495900 Tefen
ISRAEL

TRADEMARK DETAILS

ISOYTURN

Trademark Type

Standard Characters

Goods

Class 07

Cutting tools for use with power operated machines, namely, turning tools and cutting inserts therefor.

Claims

Priority Filing Date: September 08, 2020, Country or Office: ISRAEL, Application No: 331247 in association with the same kind of goods

Application Number 2,092,564
International Registration Number 1581571
Language of Application English

Filing Date 2020-10-27

APPLICANT DETAILS

Applicant

Iscar Ltd.
P.O. Box 11
2495900 Tefen
ISRAEL

TRADEMARK DETAILS

NEOSWISS

Trademark Type

Standard Characters

Goods

Class 07

Cutting tools for use with power operated machines, namely, turning tools and cutting inserts therefor.

Claims

Priority Filing Date: September 08, 2020, Country or Office: ISRAEL, Application No: 331252 in association with the same kind of goods

Application Number 2,092,565
International Registration Number 1581567
Language of Application English

Filing Date 2020-10-27

APPLICANT DETAILS

Applicant

Iscar Ltd.
P.O. Box 11
2495900 Tefen
ISRAEL

TRADEMARK DETAILS

NEOGUN

Trademark Type

Standard Characters

Goods

Class 07

Cutting tools for use with power operated machines, namely, drills, drill holders, and cutting inserts therefor.

Claims

Priority Filing Date: September 08, 2020, Country or Office: ISRAEL, Application No: 331248 in association with the same kind of goods

Application Number 2,092,566
International Registration Number 1581566
Language of Application English

Filing Date 2020-10-27

APPLICANT DETAILS

Applicant

Iscar Ltd.
P.O. Box 11
2495900 Tefen
ISRAEL

TRADEMARK DETAILS

NEOLOGIQ

Trademark Type

Standard Characters

Goods

Class 07

Cutting tools for use with power operated machines, namely, milling tools, turning tools, grooving tools, parting tools, drilling tools, and cutting inserts therefor; collets for milling and drilling tools.

Claims

Priority Filing Date: September 08, 2020, Country or Office: ISRAEL, Application No: 331242 in association with the same kind of goods

Application Number 2,092,567
International Registration Number 1581563
Language of Application English

Filing Date 2020-10-27

APPLICANT DETAILS

Applicant

Iscar Ltd.
P.O. Box 11
2495900 Tefen
ISRAEL

TRADEMARK DETAILS

NEOPICCO

Trademark Type

Standard Characters

Goods

Class 07

Cutting tools for use with power operated machines, namely, turning tools and cutting inserts therefor.

Claims

Priority Filing Date: September 08, 2020, Country or Office: ISRAEL, Application No: 331253 in association with the same kind of goods

Application Number 2,092,619
International Registration Number 1581830
Language of Application English

Filing Date 2020-11-27

APPLICANT DETAILS

Applicant

MEGINE INDUSTRIES SDN BHD
B-05-02, The Vertical Business Suites 8,
Jalan Kerinchi, Bangsar South
59200 WILAYAH PERSEKUTUAN
KUALA LUMPUR
MALAYSIA

TRADEMARK DETAILS

Trademark Type

Design

Visual Representation

The logo for Amadex features a stylized four-leaf clover symbol to the left of the word "Amadex" in a bold, sans-serif font.

Goods

Class 10

Compression gloves; disposable gloves for medical purposes; disposable gloves for surgical purposes; disposable gloves for veterinary purposes; examination gloves for medical purposes; gloves for dental purposes; gloves for massage; gloves for medical purposes; gloves for veterinary purposes; latex gloves for dental use; latex gloves for medical purposes; latex gloves for surgical purposes; massage gloves; surgical gloves.

Claims

Priority Filing Date: June 01, 2020, Country or Office: MALAYSIA, Application No: TM2020009719 in association with the same kind of goods

Application Number 2,092,715
International Registration Number 1581298
Language of Application English

Filing Date 2021-01-08

APPLICANT AND AGENT DETAILS

Applicant

Aztec Financial LLC
556 W. Confluence Avenue
Murray UT 84123
UNITED STATES OF AMERICA

Agent

RIDOUT & MAYBEE LLP
11 Holland Avenue, Suite 601 , Ottawa,
ONTARIO, K1Y4S1

TRADEMARK DETAILS

AZTEC FLEET SALES

Trademark Type

Standard Characters

Services

Class 35

(1) Retail and wholesale services for commercial vehicles.

Class 36

(2) Providing extended warranties on vehicles.

Class 37

(3) Commercial vehicle customization services, namely, installation of structural parts and accessories into vehicles used for commercial purposes.

Application Number 2,092,716
International Registration Number 1581200
Language of Application English

Filing Date 2021-01-08

APPLICANT AND AGENT DETAILS

Applicant

Aztec Financial LLC
556 W. Confluence Avenue
Murray UT 84123
UNITED STATES OF AMERICA

Agent

RIDOUT & MAYBEE LLP
11 Holland Avenue, Suite 601 , Ottawa,
ONTARIO, K1Y4S1

TRADEMARK DETAILS

Aztec Financial & Fleet Sales

Trademark Type

Standard Characters

Services

Class 35

(1) Retail and wholesale services for commercial vehicles.

Class 36

(2) Providing extended warranties on vehicles.

Class 37

(3) Commercial vehicle customization services, namely, installation of structural parts and accessories into vehicles used for commercial purposes.

Application Number 2,092,734
International Registration Number 1581552
Language of Application English

Filing Date 2021-01-13

APPLICANT DETAILS

Applicant

Otte Gear LLC
641 Shunpike Road #200
Chatham NJ 07928
UNITED STATES OF AMERICA

TRADEMARK DETAILS

Trademark Type

Design

Visual Representation



Trademark Description

The mark consists of the word "OTTE" in pixelated form above the word "GEAR", and to the left of the word "GEAR" is a circle with a cross inside.

Goods

Class 18

(1) Tote bags, backpacks, range bags, namely, general purpose duffel bags for use at the rifle range, utility pouches, luggage inserts, namely, packing cubes, all for use in connection with military and law enforcement activities, marketed to military and law enforcement personnel.

Class 25

(2) Military-grade waterproof, abrasion resistant, wind-resistant, cold-resistant clothing, namely, jackets, pants, gaiters, and gloves, all for use in connection with military and law enforcement activities, marketed to military and law enforcement personnel.

Application Number 2,092,768
International Registration Number 1582003
Language of Application English

Filing Date 2021-01-20

APPLICANT DETAILS

Applicant

Forsyth Barr Group Limited
Forsyth Barr House,
Cnr Octagon & Stuart Street
Dunedin 9054
NEW ZEALAND

TRADEMARK DETAILS

TEMPO

Trademark Type

Standard Characters

Goods

Class 16

Printed matter, namely, publications, brochures and information leaflets that relate specifically to investing in funds and stocks (but not including any insurance services advice) and that is provided to customers via a tool that is accessed by a web and mobile phone based app.

Services

Class 35

(1) Advisory and consultancy services, namely, business management, research, market analysis and compilation of statistics that relate specifically to investing in funds and stocks (but not including any insurance services or advice) and that is provided to customers via a tool that is accessed by a web and mobile phone based app.

Class 36

(2) Providing advice and information on the investing in funds and stocks (but not including any insurance services or advice) via or in relation to a tool that is accessed by a web and mobile phone based app.

Class 41

(3) Education and training services, namely, the arranging and conducting of seminars, conferences, exhibitions and workshops and publication services in relation to investing in funds and stocks (but not including any insurance services or advice) and that is provided to customers via a tool that is accessed by a web and mobile phone based app.

Application Number 2,092,789
International Registration Number 1581892
Language of Application English

Filing Date 2021-01-22

APPLICANT DETAILS

Applicant

StaCyc, Inc.
6795 Corporation Pkwy, Suite 200
Fort Worth TX 76126
UNITED STATES OF AMERICA

TRADEMARK DETAILS

Trademark Type

Design

Visual Representation



Disclaimer

The right to the exclusive use of the words "STABILITY CYCLE" is disclaimed apart from the trademark.

Goods

Class 12

Electric bicycles and structural parts therefor; Electric bicycle parts and accessories, namely, handlebar throttles, footrests and stationary stands.

Application Number 2,092,797
International Registration Number 1581840
Language of Application English

Filing Date 2021-01-25

APPLICANT DETAILS

Applicant

Central Payments, L.L.C.
2301 Independence Blvd.
Kansas City MO 64124
UNITED STATES OF AMERICA

TRADEMARK DETAILS

CENTRAL PAYMENTS

Trademark Type

Standard Characters

Services

Class 36

Financial services, namely, issuing virtual and non-virtual prepaid debit cards and prepaid debit card services, namely, processing of prepaid debit card payments, prepaid debit card transaction processing services; payroll card services, namely, issuing virtual and non-virtual prepaid debit cards to enable users to access funds loaded into a card account in cash or by an employer or other benefits provider via direct deposit.

Claims

Priority Filing Date: July 28, 2020, Country or Office: UNITED STATES OF AMERICA, Application No: 90077696 in association with the same kind of services

Application Number 2,092,837
International Registration Number 1581044
Language of Application English

Filing Date 2021-01-28

APPLICANT DETAILS

Applicant
AKIRA20 LLC
6954 NW 113 PL
Doral FL 33178
UNITED STATES OF AMERICA

TRADEMARK DETAILS

Trademark Type
Design

Visual Representation



Trademark Description

The mark consists of the letters "DELM" in gray surrounded by a gray rectangle with irregular lines. The mark is on a white background.

Goods

Class 07

Electric milk frothers.

Application Number 2,092,863
International Registration Number 1581770
Language of Application English

Filing Date 2021-02-01

APPLICANT DETAILS

Applicant

Entrepreneurs' Organization
Suite 700,
500 Montgomery Street
Alexandria VA 22314
UNITED STATES OF AMERICA

TRADEMARK DETAILS

Trademark Type

Design

Visual Representation



Trademark Description

The mark consists of the letters EO with the O consisting of five, broken line, concentric circles.

Services

Class 35

Association services, namely, promoting the interests of entrepreneurs.

Claims

Priority Filing Date: August 19, 2020, Country or Office: UNITED STATES OF AMERICA,
Application No: 90123630 in association with the same kind of services

Application Number 2,092,867
International Registration Number 1396662
Language of Application English

Filing Date 2021-02-01

APPLICANT AND AGENT DETAILS

Applicant

Makey Makey LLC
1060 River St., Unit 108
Santa Cruz CA 95060
UNITED STATES OF AMERICA

Agent

OSLER, HOSKIN & HARCOURT LLP
SUITE 6200, P.O. BOX 50, 1 FIRST
CANADIAN PLACE, TORONTO, ONTARIO,
M5X1B8

TRADEMARK DETAILS

MAKEY MAKEY

Trademark Type

Standard Characters

Services

Class 41

(1) Conducting workshops and seminars in science, technology, engineering and mathematics (STEM) education; developing education lesson plans for others in the field of science, technology, engineering and mathematics (STEM) education; educational services, namely, conducting informal programs in the fields of science, technology, engineering and mathematics (STEM) education, using on-line activities and interactive exhibits, and printable materials distributed therewith

Class 42

(2) Hosting an on-line community website featuring inventions that use invention kits and computing devices; creating an on-line community for individuals using computing devices for invention and creation

Application Number 2,092,874
International Registration Number 1581409
Language of Application English

Filing Date 2021-02-02

APPLICANT DETAILS

Applicant

Barn2Door, Inc.
1300 North Northlake Way, Suite 200
Seattle WA 98103
UNITED STATES OF AMERICA

TRADEMARK DETAILS

BARN2DOOR

Trademark Type

Standard Characters

Goods

Class 09

Downloadable computer software, namely, software for the purpose of farm management, inventory management, online sales management, shipping management, purchase processing management, accounting management, taxes tracking and management; downloadable computer software, namely, software applications for the purpose of farm management, inventory management, online sales management, shipping management, purchase processing management, accounting management, taxes tracking and management.

Services

Class 35

(1) Business administration services in connection with farm management, produce sales, flower sales, dairy sales, poultry sales, protein sales, subscription and regenerative sales for others; business administration services in connection with online sales of farm products for others; business administration services in connection with shipping management for others; business administration services in connection with processing purchase orders for others; business administration services in connection with customer support for others; business management and organization consultancy.

Class 41

(2) Providing on-line non-downloadable training videos and worksheets in the fields of farm management, website management, social media management, email and newsletter management, online order management, shipping management, inventory management, accounting management, taxes tracking and management.

Class 42

(3) Providing online non-downloadable computer software for use in farm management, inventory management, online sales management, shipping management, purchase processing management, accounting management, taxes tracking and management for others; hosting online software of others for use in farm management, inventory management, online sales management,

shipping management, purchase processing management, accounting management, taxes tracking and management.

Claims

Priority Filing Date: August 07, 2020, Country or Office: UNITED STATES OF AMERICA,
Application No: 90100771 in association with the same kind of goods and in association with the same kind of services

Application Number 2,092,875
International Registration Number 1581345
Language of Application English

Filing Date 2021-02-02

APPLICANT DETAILS

Applicant

Barn2Door, Inc.
1300 North Northlake Way, Suite 200
Seattle WA 98103
UNITED STATES OF AMERICA

TRADEMARK DETAILS

Trademark Type

Design

Visual Representation



Trademark Description

The mark consists of a stylized letter "B" containing an arrow pointing right within the letter.

Goods

Class 09

Downloadable computer software, namely, software for the purpose of farm management, inventory management, online sales management, shipping management, purchase processing management, accounting management, taxes tracking and management; downloadable computer software, namely, software applications for the purpose of farm management, inventory management, online sales management, shipping management, purchase processing management, accounting management, taxes tracking and management.

Services

Class 35

(1) Business administration services in connection with farm management, produce sales, flower sales, dairy sales, poultry sales, protein sales, subscription and regenerative sales for others;

business administration services in connection with online sales of farm products for others; business administration services in connection with shipping management for others; business administration services in connection with processing purchase orders for others; business administration services in connection with customer support for others; business management and organization consultancy.

Class 41

(2) Providing on-line non-downloadable training videos and worksheets in the fields of farm management, website management, social media management, email and newsletter management, online order management, shipping management, inventory management, accounting management, taxes tracking and management.

Class 42

(3) Providing online non-downloadable computer software for use in farm management, inventory management, online sales management, shipping management, purchase processing management, accounting management, taxes tracking and management for others; hosting online software of others for use in farm management, inventory management, online sales management, shipping management, purchase processing management, accounting management, taxes tracking and management.

Claims

Priority Filing Date: August 07, 2020, Country or Office: UNITED STATES OF AMERICA, Application No: 90100773 in association with the same kind of goods and in association with the same kind of services

Application Number 2,092,926
International Registration Number 1581967
Language of Application English

Filing Date 2021-02-08

APPLICANT DETAILS

Applicant

Applied Materials, Inc.
3050 Bowers Avenue
Santa Clara CA 95054
UNITED STATES OF AMERICA

TRADEMARK DETAILS

SIGNET

Trademark Type

Standard Characters

Goods

Class 17

Dielectric films and coatings for use in semiconductor manufacturing.

Claims

Priority Filing Date: February 03, 2021, Country or Office: UNITED STATES OF AMERICA,
Application No: 90508261 in association with the same kind of goods

Application Number 2,092,931
International Registration Number 1581674
Language of Application English

Filing Date 2021-02-09

APPLICANT DETAILS

Applicant

Anheuser-Busch InBev S.A.
Grand-Place 1
B-1000 Brussels
BELGIUM

TRADEMARK DETAILS

FRITES ARTOIS

Trademark Type

Standard Characters

Services

Class 43

Services for providing food and drink, namely bar and restaurant services.

Claims

Priority Filing Date: September 30, 2020, Country or Office: Benelux Office for IP (BOIP),
Application No: 1426072 in association with the same kind of services

Application Number 2,092,936
International Registration Number 1581751
Language of Application English

Filing Date 2021-02-10

APPLICANT AND AGENT DETAILS

Applicant

Groma, LLC
31 New Chardon Street
Boston MA 02114
UNITED STATES OF AMERICA

Agent

ROBIC
630, boul. René-Lévesque Ouest, 20e étage,
Montréal, QUEBEC, H3B1S6

TRADEMARK DETAILS

GROMA

Trademark Type

Standard Characters

Services

Class 36

(1) Real estate management services; real estate investment services.

Class 37

(2) Real estate development services; real estate development services in the field of development of residential communities and development of commercial and mixed-use properties.

Application Number 2,092,937
International Registration Number 1581689
Language of Application English

Filing Date 2021-02-10

APPLICANT DETAILS

Applicant

Brooklinen, Inc.
81 Prospect Street
Brooklyn NY 11201
UNITED STATES OF AMERICA

TRADEMARK DETAILS

BROOKLINEN

Trademark Type

Standard Characters

Goods

Class 20

Bed pillows.

Application Number 2,092,939
International Registration Number 1581665
Language of Application English

Filing Date 2021-02-10

APPLICANT AND AGENT DETAILS

Applicant

Stryker Corporation
2825 Airview Boulevard
Kalamazoo MI 49002
UNITED STATES OF AMERICA

Agent

RZESZUTEK, KATHY
(c/o Novadaq Technologies ULC/Stryker), 8329
Eastlake Drive, Unit 101, Burnaby, BRITISH
COLUMBIA, V5A4W2

TRADEMARK DETAILS

SLX300

Trademark Type

Standard Characters

Goods

Class 10

Lighting systems for medical use, namely, lights for medical examination, and parts and fittings therefor.

Claims

Priority Filing Date: August 28, 2020, Country or Office: UNITED STATES OF AMERICA,
Application No: 90145062 in association with the same kind of goods

Application Number 2,092,943
International Registration Number 1581330
Language of Application English

Filing Date 2021-02-10

APPLICANT DETAILS

Applicant

Brooklinen, Inc.
81 Prospect Street
Brooklyn NY 11201
UNITED STATES OF AMERICA

TRADEMARK DETAILS

BROOKLITTLES

Trademark Type

Standard Characters

Goods

Class 20

(1) Bed pillows.

Class 24

(2) Bed linen, namely, sheets, pillowcases, blankets, quilts, and comforters; throw blankets; swaddling blankets.

Class 28

(3) Stuffed toy animals.

Application Number 2,092,945
International Registration Number 1581283
Language of Application English

Filing Date 2021-02-10

APPLICANT DETAILS

Applicant

Brooklinen, Inc.
81 Prospect Street
Brooklyn NY 11201
UNITED STATES OF AMERICA

TRADEMARK DETAILS

SPACES BY BROOKLINEN

Trademark Type

Standard Characters

Services

Class 35

Online retail stores services featuring home furnishings, décor, rugs, lighting, furniture, and art.

Application Number 2,092,946
International Registration Number 1581250
Language of Application English

Filing Date 2021-02-10

APPLICANT DETAILS

Applicant

Brooklinen, Inc.
77 Sands Street
Brooklyn NY 11201
UNITED STATES OF AMERICA

TRADEMARK DETAILS

BROOKLINEN COMFORT CREW

Trademark Type

Standard Characters

Disclaimer

The right to the exclusive use of the word "CREW" is disclaimed apart from the trademark.

Services

Class 35

Providing incentive award programs for customers through the distribution of reward points which can be redeemed for discounts, select products, or donated to a charity, all for the purpose of promoting and rewarding loyalty.

Application Number 2,092,948
International Registration Number 1581195
Language of Application English

Filing Date 2021-02-10

APPLICANT DETAILS

Applicant

Brooklinen, Inc.
81 Prospect Street
Brooklyn NY 11201
UNITED STATES OF AMERICA

TRADEMARK DETAILS

BROOKLINEN

Trademark Type

Standard Characters

Goods

Class 24

Throw blankets, comforters, duvets, and duvet covers.

Application Number 2,092,949
International Registration Number 1581167
Language of Application English

Filing Date 2021-02-10

APPLICANT DETAILS

Applicant

FIGS, Inc.
2834 Colorado Avenue, Suite 100
Santa Monica CA 90404
UNITED STATES OF AMERICA

TRADEMARK DETAILS

FIGS

Trademark Type

Standard Characters

Goods

Class 10

Sanitary masks made of cloth for reduction in the spread of disease.

Claims

Priority Filing Date: August 10, 2020, Country or Office: UNITED STATES OF AMERICA,
Application No: 90103641 in association with the same kind of goods

Application Number 2,092,950
International Registration Number 1581112
Language of Application English

Filing Date 2021-02-10

APPLICANT DETAILS

Applicant

Brooklinen, Inc.
81 Prospect Street
Brooklyn NY 11201
UNITED STATES OF AMERICA

TRADEMARK DETAILS

BROOKLINEN

Trademark Type

Standard Characters

Goods

Class 24

(1) Bath towels.

Class 27

(2) Bath mats.

Application Number 2,092,951
International Registration Number 1581111
Language of Application English

Filing Date 2021-02-10

APPLICANT DETAILS

Applicant

Brooklinen, Inc.
81 Prospect Street
Brooklyn NY 11201
UNITED STATES OF AMERICA

TRADEMARK DETAILS

BROOKLINEN

Trademark Type

Standard Characters

Goods

Class 04

Candles.

Application Number 2,092,952
International Registration Number 1581110
Language of Application English

Filing Date 2021-02-10

APPLICANT DETAILS

Applicant

Brooklinen, Inc.
33 NASSAU AVENUE
Brooklyn NY 11222
UNITED STATES OF AMERICA

TRADEMARK DETAILS

Brooklinen

Trademark Type

Standard Characters

Goods

Class 24

Bed linen.

Application Number 2,092,953
International Registration Number 1582156
Language of Application English

Filing Date 2021-02-10

APPLICANT DETAILS

Applicant

Adaptive Spectrum and Signal Alignment, Inc.
203 Redwood Shores Parkway, Suite 100
Redwood City CA 94065
UNITED STATES OF AMERICA

TRADEMARK DETAILS

WORKPUT

Trademark Type

Standard Characters

Goods

Class 09

Downloadable software for assessing the value of an employee's productivity related to electronic communication; downloadable software for assigning a score for an employee's productivity related to electronic communication.

Services

Class 42

Software as a service (SAAS) services featuring software for assessing the value of an employee's productivity related to electronic communication; software as a service (SAAS) services featuring software for assigning a score for an employee's productivity related to electronic communication.

Claims

Priority Filing Date: August 20, 2020, Country or Office: UNITED STATES OF AMERICA,
Application No: 90127534 in association with the same kind of goods and in association with the same kind of services

Application Number 2,092,958
International Registration Number 1581154
Language of Application English

Filing Date 2021-02-11

APPLICANT DETAILS

Applicant
Samtec Inc.
520 Park East Blvd.
New Albany IN 47151
UNITED STATES OF AMERICA

TRADEMARK DETAILS

SUPERNOVA

Trademark Type
Standard Characters

Goods

Class 09

Electrical connectors.

Claims

Priority Filing Date: August 26, 2020, Country or Office: UNITED STATES OF AMERICA,
Application No: 90138701 in association with the same kind of goods

Application Number 2,092,959
International Registration Number 1582159
Language of Application English

Filing Date 2021-02-11

APPLICANT AND AGENT DETAILS

Applicant

Kollmorgen Corporation
203A West Rock Road
Radford VA 24141
UNITED STATES OF AMERICA

Agent

ROBIC
630, boul. René-Lévesque Ouest, 20e étage,
Montréal, QUEBEC, H3B1S6

TRADEMARK DETAILS

SAFEMOTION

Trademark Type

Standard Characters

Goods

Class 09

Recorded computer software and firmware for drives used in controlling electric motors and electromechanical brakes; downloadable computer software and firmware for drives used in controlling electric motors and electromechanical brakes.

Claims

Priority Filing Date: September 08, 2020, Country or Office: UNITED STATES OF AMERICA,
Application No: 90165283 in association with the same kind of goods

Application Number 2,092,988
International Registration Number 1026391
Language of Application English

Filing Date 2021-02-26

APPLICANT DETAILS

Applicant

Alima Cosmetics, Inc.
1601 NW Savier Street
Portland OR 97209
UNITED STATES OF AMERICA

TRADEMARK DETAILS

ALIMA PURE

Trademark Type

Standard Characters

Disclaimer

"PURE".

Goods

Class 03

Cosmetics and make-up.

Application Number 2,092,990
International Registration Number 1580586
Language of Application English

Filing Date 2021-03-01

APPLICANT DETAILS

Applicant

Wayfarer Entertainment, LLC
4223 Glencoe Ave Suite B-130
Marina Del Rey CA 90292
UNITED STATES OF AMERICA

TRADEMARK DETAILS

MAN ENOUGH

Trademark Type

Standard Characters

Services

Class 41

Entertainment services in the nature of development, creation, production, distribution, and post-production of a continuing television series featuring issues of particular interest to or impacting men; entertainment services in the nature of production of a television talk show featuring issues of particular interest to or impacting men; entertainment services, namely, production and distribution of ongoing television programs featuring issues of particular interest to or impacting men; entertainment, namely, a continuing television show featuring issues of particular interest to or impacting men, broadcast over television, satellite, audio, and video media; production and distribution of motion pictures; production of television programs; production of cable television programs; production of radio and television programmes; production of radio and television programs; production of radio or television programs; publishing of books, e-books, audio books, music and illustrations; entertainment services, namely, ongoing radio program production in the field of masculinity and other topics pertaining to men; entertainment services, namely, production of podcasts in the field of masculinity and other topics for men; entertainment services, namely, production of video podcasts in the field of masculinity and other topics pertaining to men; television show production; education and entertainment services in the nature of ongoing television public service announcements and ongoing television programs in the field of topics affecting men, masculinity or personal relationships; entertainment in the nature of ongoing television programs in the field of masculinity and personal relationships; entertainment media production services for motion pictures, television and internet; entertainment services in the nature of an ongoing reality based television program; entertainment services in the nature of creation, development, and production of television programming.

Application Number 2,092,991
International Registration Number 1565792
Language of Application English

Filing Date 2021-03-01

APPLICANT DETAILS

Applicant
TERRA VISTA GESTORA DE RECURSOS
LTDA
Avenida Brigadeiro Faria Lima 3144,
3° andar
01451-000 São Paulo
BRAZIL

TRADEMARK DETAILS

Trademark Type
Design

Visual Representation



MO.SS

Services

Class 36

Brokerage of carbon credits; crowdfunding; investment of funds; capital investment.

Application Number 2,092,993
International Registration Number 1394685
Language of Application English

Filing Date 2021-03-01

APPLICANT DETAILS

Applicant

BridgehouseLaw Alliance, LLC
112 South Tryon St., Suite 1100
Charlotte NC 28284
UNITED STATES OF AMERICA

TRADEMARK DETAILS

Trademark Type

Design

Visual Representation



Trademark Description

The mark consists of a circle divided into two uneven sections in the center by the silhouette of a single span of an arch bridge followed by the phrase "BridgehouseLaw" all of which appears in maroon.

Colour Claim

The color maroon is claimed as a feature of the mark. The mark consists of a circle divided into two uneven sections in the center by the silhouette of a single span of an arch bridge followed by the phrase "BridgehouseLaw" all of which appears in maroon.

Services

Class 45

Legal services.

Application Number 2,093,621
Language of Application English

Filing Date 2021-03-22

APPLICANT AND AGENT DETAILS

Applicant

MEETS TOYS CO., LTD
UNIT G25 WATERFRONT STUDIOS, 1 DOCK
ROAD
LONDON, E16 1AH
UNITED KINGDOM

Agent

YURI CHUMAK
c/o Dickinson Wright LLP, 199 Bay Street,
Suite 2200, Toronto, ONTARIO, M5L1G4

TRADEMARK DETAILS

limbs

Trademark Type

Standard Characters

Goods

Class 28

artificial Christmas trees; baby toys; bath toys; candle holders for Christmas trees; dolls; dolls for playing; dolls' clothes; European style dolls; fish hooks; fishing tackle; jigsaw puzzles; pet toys; puppets; stuffed toys; talking dolls; toy animals; toy cars; toy furniture; toy masks; toys for dogs

Application Number 2,093,622
Language of Application English

Filing Date 2021-03-22

APPLICANT AND AGENT DETAILS

Applicant

MEETS TOYS CO., LTD
UNIT G25 WATERFRONT STUDIOS, 1 DOCK
ROAD
LONDON, E16 1AH
UNITED KINGDOM

Agent

YURI CHUMAK
c/o Dickinson Wright LLP, 199 Bay Street,
Suite 2200, Toronto, ONTARIO, M5L1G4

TRADEMARK DETAILS

hair

Trademark Type

Standard Characters

Goods

Class 28

artificial Christmas trees; baby toys; bath toys; candle holders for Christmas trees; dolls; dolls for playing; dolls' clothes; European style dolls; fish hooks; fishing tackle; jigsaw puzzles; pet toys; puppets; stuffed toys; talking dolls; toy animals; toy cars; toy furniture; toy masks; toys for dogs

Application Number 2,093,623
Language of Application English

Filing Date 2021-03-22

APPLICANT AND AGENT DETAILS

Applicant

MEETS TOYS CO., LTD
UNIT G25 WATERFRONT STUDIOS, 1 DOCK
ROAD
LONDON, E16 1AH
UNITED KINGDOM

Agent

YURI CHUMAK
c/o Dickinson Wright LLP, 199 Bay Street,
Suite 2200, Toronto, ONTARIO, M5L1G4

TRADEMARK DETAILS

Full body

Trademark Type

Standard Characters

Goods

Class 28

artificial Christmas trees; baby toys; bath toys; candle holders for Christmas trees; dolls; dolls for playing; dolls' clothes; European style dolls; fish hooks; fishing tackle; jigsaw puzzles; pet toys; puppets; stuffed toys; talking dolls; toy animals; toy cars; toy furniture; toy masks; toys for dogs

Application Number 2,094,382
International Registration Number 1582482
Language of Application English

Filing Date 2020-11-10

APPLICANT DETAILS

Applicant

Fernwayer LLC
2106 Divisadero St.
San Francisco CA 94115
UNITED STATES OF AMERICA

TRADEMARK DETAILS

FERNWAYER

Trademark Type

Standard Characters

Goods

Class 09

Computer software for allowing users to engage in social networking and share travel stories with one another that may be downloaded from a global computer network; Downloadable mobile applications for booking travel; Downloadable mobile applications for custom travel planning, designing travel itineraries and tracking travel goals; Downloadable computer application software for mobile phones, namely, software for use in booking travel; Downloadable computer application software for mobile phones, namely, software for use in custom travel planning, designing travel itineraries and tracking travel goals; Downloadable computer application software for mobile devices, namely, software for custom travel planning, designing travel itineraries and tracking travel goals.

Services

Class 42

Computer services, namely, creating an on-line community for registered users to engage in social networking and share travel stories; Providing on-line non-downloadable software for use in custom travel; Providing on-line non-downloadable software for planning, designing travel itineraries and tracking travel goals; Providing an online non-downloadable Internet-based system application featuring technology enabling users to customize travel planning, design travel itineraries and track travel goals.

Application Number 2,094,385
International Registration Number 1583047
Language of Application English

Filing Date 2020-11-11

APPLICANT DETAILS

Applicant
SALTO SYSTEMS, S.L.
Arkotz, 9
E-20180 OIARTZUN (Guipúzcoa)
SPAIN

TRADEMARK DETAILS

SALTONEOXX

Trademark Type
Standard Characters

Goods

Class 09

Electronic door locks; padlocks, electronic; cloud-based server software enabling interaction with electronic locks and padlocks; downloadable software applications enabling interaction with electronic locks and padlocks.

Application Number 2,094,401
International Registration Number 1583336
Language of Application English

Filing Date 2020-11-20

APPLICANT DETAILS

Applicant

TIBCO Software Inc.
3303 Hillview Avenue
Palo Alto CA 94304
UNITED STATES OF AMERICA

TRADEMARK DETAILS

GatherSmart

Trademark Type

Standard Characters

Goods

Class 09

Downloadable mobile applications for businesses to provide consumers with information relating to public safety and for consumers to provide feedback, ratings, reviews, and recommendations.

Services

Class 42

(1) Providing non-downloadable computer software enabling users to aggregate regulations and guidelines relating to public safety via a website.

Class 45

(2) Providing regulations and guidelines in the field of public safety via a website.

Claims

Priority Filing Date: May 22, 2020, Country or Office: UNITED STATES OF AMERICA, Application No: 88930217 in association with the same kind of goods and in association with the same kind of services

Application Number 2,094,467
International Registration Number 1582292
Language of Application English

Filing Date 2020-12-22

APPLICANT DETAILS

Applicant

Pilkington Group Limited
European Technical Centre,
Hall Lane, Lathom, Nr. Ormskirk
Lancashire L40 5UF
UNITED KINGDOM

TRADEMARK DETAILS

Trademark Type

Design

Visual Representation



Goods

Class 09

Calibration devices for calibrating an advanced driver assistance system; optical apparatus and instruments for calibrating an advanced driver assistance system; programmable electronic apparatus for calibrating an advanced driver assistance system; measuring apparatus for calibrating an advanced driver assistance system; measuring instruments for calibrating an advanced driver assistance system; vehicle automatic driving control devices for calibrating an advanced driver assistance system.

Services

Class 37

Vehicle maintenance and repair; vehicle window replacement services, namely advisory and consultancy services related to the replacement of vehicle windows; vehicle windscreen replacement services, namely advisory and consultancy services related to the replacement of vehicle windscreens; advisory services relating to vehicle repair, vehicle repair including the fitting of replacement vehicle windows; vehicle repair including the fitting of replacement vehicle windscreens; vehicle repair and maintenance including the fitting of replacement windows in motor vehicles; vehicle repair and maintenance including the fitting of replacement windscreens in motor vehicles; information and consultancy services relating to vehicle repair; installation of parts for vehicles; installation of windscreens; providing information relating to the repair or maintenance of automobiles; provision of information relating to the repair of vehicles.

Claims

Priority Filing Date: July 24, 2020, Country or Office: UNITED KINGDOM, Application No: UK00003515426 in association with the same kind of goods and in association with the same kind of services

Application Number 2,094,477
International Registration Number 1583287
Language of Application English

Filing Date 2020-12-25

APPLICANT DETAILS

Applicant

Xiamen Sungiven Foods Holding Co., Ltd.
Unit 01, 02,
Hudu Century Building 24F,
No.7 Yilan Road, Siming District,
Xiamen City
361000 Fujian Province
CHINA

TRADEMARK DETAILS

Trademark Type

Design

Visual Representation



Goods

Class 32

(1) Tomato juice beverages; seltzer water; non-alcoholic beverages flavoured with coffee; non-alcoholic beverages flavoured with tea; pineapple juice beverages; orange juice beverages; non-alcoholic carbonated beverages; soft drinks; table waters; non-alcoholic vegetable juice beverages; fruit juices; mineral water; beer; soda water; non-alcoholic fruit juice beverages.

Class 33

(2) Alcoholic fruit cocktail drinks; yellow rice wine; aperitifs; rice alcohol; wine; sake.

Application Number 2,094,495
International Registration Number 1582806
Language of Application English

Filing Date 2021-01-06

APPLICANT DETAILS

Applicant

Conveyal LLC
64 Pleasant Street
Watertown MA 02472
UNITED STATES OF AMERICA

TRADEMARK DETAILS

Conveyal

Trademark Type

Standard Characters

Services

Class 42

Software design and development; architectural design services in the fields of traffic and transportation; software as a service (SAAS) services featuring software for transportation planning.

Application Number 2,094,520
International Registration Number 1582240
Language of Application English

Filing Date 2021-01-14

APPLICANT AND AGENT DETAILS

Applicant

Biorchestra Co., Ltd.
116/216, Venture-dong, KRIBB
125 Gwahak-ro, Yuseong-gu
Daejeon 34141
REPUBLIC OF KOREA

Agent

SMART & BIGGAR LLP
1000 RUE DE LA GAUCHETIERE OUEST,
BUREAU 3300, MONTREAL, QUEBEC,
H3B4W5

TRADEMARK DETAILS

TRANSTRA

Trademark Type

Standard Characters

Goods

Class 01

(1) Chemical reagents for cellular transfection of RNA, peptides, and chemical compounds, for scientific and research use, not for medical or veterinary purposes.

Class 05

(2) Drug delivery agents in the form of compounds in the nature of liquid solutions and lyophilized powder that facilitate delivery of injectable pharmaceutical and veterinary pharmaceutical preparations.

Claims

Priority Filing Date: July 27, 2020, Country or Office: UNITED STATES OF AMERICA, Application No: 90075824 in association with the same kind of goods

Application Number 2,094,551
International Registration Number 1582243
Language of Application English

Filing Date 2021-01-25

APPLICANT DETAILS

Applicant
TEE-2-GREEN CORPORATION
29975 S BARLOW RD
CANBY OR 97013
UNITED STATES OF AMERICA

TRADEMARK DETAILS

Trademark Type
Design

Visual Representation



Trademark Description

The mark consists of the letters PS inside of a circle.

Goods

Class 31

Grass seed.

Claims

Priority Filing Date: July 31, 2020, Country or Office: UNITED STATES OF AMERICA, Application No: 90087112 in association with the same kind of goods

Application Number 2,094,553
International Registration Number 1582221
Language of Application English

Filing Date 2021-01-25

APPLICANT DETAILS

Applicant

Central Payments, L.L.C.
2301 Independence Blvd.
Kansas City MO 64124
UNITED STATES OF AMERICA

TRADEMARK DETAILS

Trademark Type

Design

Visual Representation



Trademark Description

The mark consists of a diamond-shaped logo followed by the words Central Payments.

Services

Class 36

Financial services, namely, issuing virtual and non-virtual prepaid debit cards and prepaid debit card services, namely, processing of prepaid debit card payments, prepaid debit card transaction processing services; payroll card services, namely, issuing virtual and non-virtual prepaid debit cards to enable users to access funds loaded into a card account in cash or by an employer or other benefits provider via direct deposit.

Claims

Priority Filing Date: July 28, 2020, Country or Office: UNITED STATES OF AMERICA, Application No: 90077754 in association with the same kind of services

Application Number 2,094,592
International Registration Number 1582534
Language of Application English

Filing Date 2021-02-01

APPLICANT DETAILS

Applicant

Entrepreneurs' Organization
Suite 700,
500 Montgomery Street
Alexandria VA 22314
UNITED STATES OF AMERICA

TRADEMARK DETAILS

Trademark Type

Design

Visual Representation



Trademark Description

The mark consists of five, broken line, concentric circles.

Services

Class 35

Association services, namely, promoting the interests of entrepreneurs.

Claims

Priority Filing Date: August 19, 2020, Country or Office: UNITED STATES OF AMERICA,
Application No: 90123551 in association with the same kind of services

Application Number 2,094,594
International Registration Number 1383371
Language of Application English

Filing Date 2021-02-01

APPLICANT AND AGENT DETAILS

Applicant

Makey Makey LLC
1060 River St., Unit 108
Santa Cruz CA 95060
UNITED STATES OF AMERICA

Agent

OSLER, HOSKIN & HARCOURT LLP
SUITE 6200, P.O. BOX 50, 1 FIRST
CANADIAN PLACE, TORONTO, ONTARIO,
M5X1B8

TRADEMARK DETAILS

Trademark Type

Design

Visual Representation



Trademark Description

The mark consists of a keyboard key with a banana on it, followed by the words "MAKEY MAKEY" in a stylized font.

Services

Class 41

(1) Conducting workshops and seminars in science, technology, engineering and mathematics (STEM) education; developing education lesson plans for others in the field of science, technology, engineering and mathematics (STEM) education; educational services, namely, conducting informal programs in the fields of science, technology, engineering and mathematics (STEM) education, using on-line activities and interactive exhibits, and printable materials distributed therewith.

Class 42

(2) Hosting an on-line community website featuring inventions that use invention kits and computing devices; creating an on-line community for individuals using computing devices for invention and creation.

Application Number 2,094,602
International Registration Number 1582194
Language of Application English

Filing Date 2021-02-01

APPLICANT DETAILS

Applicant
LOWA Sportschuhe GmbH
Hauptstraße 19
85305 Jetzendorf
GERMANY

TRADEMARK DETAILS

COMBAT BOOT MK2

Trademark Type
Standard Characters

Goods

Class 25

Footwear, in particular lace boots, boots as well as walking shoes.

Claims

Priority Filing Date: September 15, 2020, Country or Office: GERMANY, Application No: 30 2020 112 731 in association with the same kind of goods

Application Number 2,094,604
International Registration Number 1582191
Language of Application English

Filing Date 2021-02-01

APPLICANT DETAILS

Applicant
LOWA Sportschuhe GmbH
Hauptstraße 19
85305 Jetzendorf
GERMANY

TRADEMARK DETAILS

BREACHER

Trademark Type
Standard Characters

Goods

Class 25

Footwear, in particular lace boots, boots as well as walking shoes.

Claims

Priority Filing Date: September 15, 2020, Country or Office: GERMANY, Application No: 30 2020 112 732 in association with the same kind of goods

Application Number 2,094,607
International Registration Number 1582884
Language of Application English

Filing Date 2021-02-02

APPLICANT DETAILS

Applicant
ALICE CESARINI; CHIARA CESARINI
Via Fonte Luglio, 2A
I-06035 GUALDO CATTANEO (PG)
ITALY

TRADEMARK DETAILS

ROSSOBASTARDO

Trademark Type
Standard Characters

Goods

Class 33

Alcoholic beverages namely wine, alcoholic cocktails, alcoholic bitters.

Application Number 2,094,611
International Registration Number 1582418
Language of Application English

Filing Date 2021-02-02

APPLICANT DETAILS

Applicant

Siemens Healthcare GmbH
Henkestraße 127
91052 Erlangen
GERMANY

TRADEMARK DETAILS

MAGNETOM Free.RT

Trademark Type

Standard Characters

Goods

Class 10

Medical instruments and apparatus and parts therefor, in particular magnetic resonance imaging devices.

Claims

Priority Filing Date: August 20, 2020, Country or Office: EUIPO (EU), Application No: 018294206 in association with the same kind of goods

Application Number 2,094,613
International Registration Number 1582404
Language of Application English

Filing Date 2021-02-02

APPLICANT DETAILS

Applicant

Siemens Healthcare GmbH
Henkestraße 127
91052 Erlangen
GERMANY

TRADEMARK DETAILS

MAGNETOM Free.Elite

Trademark Type

Standard Characters

Goods

Class 10

Medical instruments and apparatus and parts therefor, in particular magnetic resonance imaging devices.

Claims

Priority Filing Date: August 20, 2020, Country or Office: EUIPO (EU), Application No: 018294205 in association with the same kind of goods

Application Number 2,094,621
International Registration Number 1582178
Language of Application English

Filing Date 2021-02-03

APPLICANT DETAILS

Applicant

BDE Capital Pty Ltd
84 McKinnon Road
McKinnon VIC 3204
AUSTRALIA

TRADEMARK DETAILS

Hey Bud

Trademark Type

Standard Characters

Goods

Class 03

Beauty masks.

Claims

Priority Filing Date: December 30, 2020, Country or Office: AUSTRALIA, Application No: 2144026
in association with the same kind of goods

Application Number 2,094,632
International Registration Number 1582708
Language of Application English

Filing Date 2021-02-05

APPLICANT DETAILS

Applicant
INSURIFY INC
222 3RD ST, SUITE 4000
CAMBRIDGE MA 02142
UNITED STATES OF AMERICA

TRADEMARK DETAILS

INSURIFY

Trademark Type
Standard Characters

Services

Class 35

(1) Insurance lead collection and matching services, namely, matching consumer requests for insurance policy quotes collected over the internet to pre-qualified insurance brokers, agents and agencies interested in those requests.

Class 36

(2) Insurance agencies; Insurance information and consultancy; Providing insurance premium rate quotes via on-line, telephone and mail means.

Application Number 2,094,640
International Registration Number 1583058
Language of Application English

Filing Date 2021-02-08

APPLICANT AND AGENT DETAILS

Applicant

Blue Note Therapeutics, Inc.
No. 55709,
548 Market Street
San Francisco CA 94104-5401
UNITED STATES OF AMERICA

Agent

SMART & BIGGAR LLP
1100-150 York street, TORONTO, ONTARIO,
M5H3S5

TRADEMARK DETAILS

ATTUNE

Trademark Type

Standard Characters

Goods

Class 09

Downloadable computer software for diagnosing and treating comorbidities of cancer.

Claims

Priority Filing Date: September 02, 2020, Country or Office: UNITED STATES OF AMERICA,
Application No: 90152967 in association with the same kind of goods

Application Number 2,094,660
International Registration Number 1582957
Language of Application English

Filing Date 2021-02-11

APPLICANT DETAILS

Applicant

Editions de Parfums LLC
767 Fifth Avenue
New York NY 10153
UNITED STATES OF AMERICA

TRADEMARK DETAILS

ROSE TONNERRE

Trademark Type

Standard Characters

Goods

Class 03

Cosmetics; fragrances for personal use; non-medicated skin care preparations.

Claims

Priority Filing Date: January 29, 2021, Country or Office: UNITED STATES OF AMERICA,
Application No: 90497895 in association with the same kind of goods

Application Number 2,094,662
International Registration Number 1582665
Language of Application English

Filing Date 2021-02-11

APPLICANT AND AGENT DETAILS

Applicant

Corteva Agriscience LLC
9330 Zionsville Road
Indianapolis IN 46268
UNITED STATES OF AMERICA

Agent

BERESKIN & PARR LLP/S.E.N.C.R.L., S.R.L.
SCOTIA PLAZA, 40 KING STREET WEST,
40th FLOOR, TORONTO, ONTARIO, M5H3Y2

TRADEMARK DETAILS

JEMVELVA

Trademark Type

Standard Characters

Goods

Class 05

Insecticide.

Claims

Priority Filing Date: February 08, 2021, Country or Office: UNITED STATES OF AMERICA,
Application No: 90518208 in association with the same kind of goods

Application Number 2,094,663
International Registration Number 1582664
Language of Application English

Filing Date 2021-02-11

APPLICANT AND AGENT DETAILS

Applicant

Corteva Agriscience LLC
9330 Zionsville Road
Indianapolis IN 46268
UNITED STATES OF AMERICA

Agent

BERESKIN & PARR LLP/S.E.N.C.R.L., S.R.L.
SCOTIA PLAZA, 40 KING STREET WEST,
40th FLOOR, TORONTO, ONTARIO, M5H3Y2

TRADEMARK DETAILS

QALCOVA

Trademark Type

Standard Characters

Goods

Class 05

Insecticide.

Claims

Priority Filing Date: February 08, 2021, Country or Office: UNITED STATES OF AMERICA,
Application No: 90518220 in association with the same kind of goods

Application Number 2,094,665
International Registration Number 1582578
Language of Application English

Filing Date 2021-02-11

APPLICANT AND AGENT DETAILS

Applicant

Blisslights, LLC
2625 Temple Heights Drive, Unit A
Oceanside CA 92056
UNITED STATES OF AMERICA

Agent

GOWLING WLG (CANADA) LLP
1 PLACE VILLE MARIE, 37TH FLOOR/37E
ETAGE, MONTREAL, QUEBEC, H3B3P4

TRADEMARK DETAILS

Trademark Type

Design

Visual Representation



Trademark Description

The mark consists of the word "ARK" underneath an arch having a notch on the right side.

Goods

Class 11

Laser light projector for home, personal or recreational use.

Claims

Priority Filing Date: August 12, 2020, Country or Office: UNITED STATES OF AMERICA,
Application No: 90110659 in association with the same kind of goods

Application Number 2,094,666
International Registration Number 1582477
Language of Application English

Filing Date 2021-02-11

APPLICANT DETAILS

Applicant
VIGNOBLES SULLIVAN, LLC
844 ALTON RD.
MIAMI BEACH FL 33139
UNITED STATES OF AMERICA

TRADEMARK DETAILS

CHATEAU AUGUSTE

Trademark Type
Standard Characters

Disclaimer
The right to the exclusive use of the word "CHATEAU" is disclaimed apart from the trademark.

Goods

Class 33
Wines and grape wines.

Application Number 2,094,667
International Registration Number 1582459
Language of Application English

Filing Date 2021-02-11

APPLICANT DETAILS

Applicant
VIGNOBLES SULLIVAN, LLC
844 ALTON RD.
MIAMI BEACH FL 33139
UNITED STATES OF AMERICA

TRADEMARK DETAILS

CHATEAU Du PARC

Trademark Type
Standard Characters

Disclaimer
The right to the exclusive use of the word "CHATEAU" is disclaimed apart from the trademark.

Goods

Class 33
Wines and grape wine.

Application Number 2,094,669
International Registration Number 1582333
Language of Application English

Filing Date 2021-02-12

APPLICANT AND AGENT DETAILS

Applicant

Langmeil Pty Ltd
Cnr Langmeil and Para Roads
Tanunda SA 5352
AUSTRALIA

Agent

PALMER IP INC.
704 - 1478 Hastings St. West, Vancouver,
BRITISH COLUMBIA, V6G3J6

TRADEMARK DETAILS

BIG SKY COUNTRY

Trademark Type

Standard Characters

Goods

Class 33

Wine.

Application Number 2,094,673
International Registration Number 1583201
Language of Application English

Filing Date 2021-02-12

APPLICANT DETAILS

Applicant
HOLISTIC HEALTH, INC.
9070 GLEANNLOCH FOREST DRIVE,
SUITE 100
SPRING TX 77379
UNITED STATES OF AMERICA

TRADEMARK DETAILS

Trademark Type
Design

Visual Representation



Trademark Description

The mark consists of a graphic stylized logo with the letters "T" and "F" framed by an incomplete hexagon with three breaks, one break is located in the left center, the second break is located in the right center, and the last is located at the top of the hexagon.

Goods

Class 25

Clothing, namely, t-shirts, tank tops, shirts, long-sleeved shirts, shorts, pants, jackets, athletic apparel, namely, pullover hoodies, sweatshirts, jogging pants, leggings, hats and caps, and windbreakers.

Claims

Priority Filing Date: September 01, 2020, Country or Office: UNITED STATES OF AMERICA, Application No: 90151087 in association with the same kind of goods

Application Number 2,094,675
International Registration Number 1583097
Language of Application English

Filing Date 2021-02-12

APPLICANT DETAILS

Applicant

HALO LIFE, LLC
Suite 1402D
1375 Corporate Center Parkway
Santa Rosa CA 95407
UNITED STATES OF AMERICA

TRADEMARK DETAILS

Trademark Type

Design

Visual Representation



HALO
LIFE

Trademark Description

The mark consists of the mark HALOLIFE depicted in a stacked format with the word HALO over the word LIFE, and with a halo hovering over the letter O.

Goods

Class 10

Sanitary masks for medical wellness purposes; sanitary masks for protection against viral infection; sanitary masks made of cloth for protection against viral infection; fashion masks being sanitary masks for protection against viral infection; reusable sanitary masks for protection against viral infection.

Claims

Priority Filing Date: August 12, 2020, Country or Office: UNITED STATES OF AMERICA, Application No: 90110434 in association with the same kind of goods

Application Number 2,094,679
International Registration Number 1582836
Language of Application English

Filing Date 2021-02-12

APPLICANT DETAILS

Applicant

JJ Acquisition, LLC
8501 Fallbrook Avenue, #370
West Hills CA 91304
UNITED STATES OF AMERICA

TRADEMARK DETAILS

DILLENIA

Trademark Type

Standard Characters

Goods

Class 10

Glass dildos.

Claims

Priority Filing Date: August 12, 2020, Country or Office: UNITED STATES OF AMERICA,
Application No: 90109417 in association with the same kind of goods

Application Number 2,094,684
International Registration Number 1582718
Language of Application English

Filing Date 2021-02-15

APPLICANT DETAILS

Applicant
BASF SE
Carl-Bosch-Str. 38
Ludwigshafen am Rhein
GERMANY

TRADEMARK DETAILS

AXA

Trademark Type
Standard Characters

Goods

Class 05

Insecticides.

Claims

Priority Filing Date: August 25, 2020, Country or Office: GERMANY, Application No: 30 2020 018 215 in association with the same kind of goods

Application Number 2,094,687
International Registration Number 1583259
Language of Application English

Filing Date 2021-02-16

APPLICANT AND AGENT DETAILS

Applicant

FASHION SEAL CORPORATION
101 Convention Center Drive, Suite 850
Las Vegas NV 89109
UNITED STATES OF AMERICA

Agent

LAVERY, DE BILLY, LLP
1 Place Ville Marie, Suite 4000, Montréal,
QUEBEC, H3B4M4

TRADEMARK DETAILS

FASHION SEAL HEALTHCARE

Trademark Type

Standard Characters

Goods

Class 10

(1) Medical apparel in the nature of tops, bottoms, pants for use in medical examination and treatment; medical treatment apparel; operating room apparel; surgical scrub pants; surgical scrub tops.

Class 25

(2) Medical, hospital and professional uniforms, aprons, blouses, boots, caps, coats, dresses, gloves, gowns, jackets, capes, pinafores, robes, shirts, skirts, smocks, suits and trousers.

Application Number 2,094,691
International Registration Number 1583145
Language of Application English

Filing Date 2021-02-16

APPLICANT DETAILS

Applicant

CenturyLink Communications, LLC
100 CenturyLink Drive
Monroe LA 71203
UNITED STATES OF AMERICA

TRADEMARK DETAILS

DDoS HYPER

Trademark Type

Standard Characters

Services

Class 42

Computer network security services, namely, monitoring, filtering, blocking and routing of network traffic for security purposes, for purposes of preventing distributed denial of service (DDoS) attacks on computer servers connected to the Internet; computer security service, namely, restricting suspicious or malicious traffic intended to disrupt the performance or availability of customers' Internet connections, web-facing systems or web-facing applications.

Claims

Priority Filing Date: August 21, 2020, Country or Office: UNITED STATES OF AMERICA,
Application No: 90129638 in association with the same kind of services

Application Number 2,094,692
International Registration Number 1583093
Language of Application English

Filing Date 2021-02-16

APPLICANT DETAILS

Applicant

Yomali Labs Limited
The Academy, Suite 1000,
42 Pearse Street,
Dublin
D02 YX88
IRELAND

TRADEMARK DETAILS

Trademark Type

Design

Visual Representation



Trademark Description

The mark consists of a zigzag line forming the letters M and W which are overlapping.

Services

Class 42

Platform as a Service (PaaS) services featuring online non-downloadable software for the creation, deployment, management and tracking of affiliate marketing campaigns.

Claims

Priority Filing Date: December 31, 2020, Country or Office: UNITED STATES OF AMERICA,
Application No: 90440893 in association with the same kind of services

Application Number 2,094,694
International Registration Number 1582879
Language of Application English

Filing Date 2021-02-16

APPLICANT DETAILS

Applicant
KOVAL Inc.
4241 N Ravenswood Ave
Chicago IL 60613
UNITED STATES OF AMERICA

TRADEMARK DETAILS

Susan for President

Trademark Type
Standard Characters

Goods

Class 33

Brandy; gin; liqueurs; whiskey.

Application Number 2,094,695
International Registration Number 1582858
Language of Application English

Filing Date 2021-02-16

APPLICANT AND AGENT DETAILS

Applicant

FASHION SEAL CORPORATION
101 Convention Center Drive, Suite 850
Las Vegas NV 89109
UNITED STATES OF AMERICA

Agent

LAVERY, DE BILLY, LLP
1 Place Ville Marie, Suite 4000, Montréal,
QUEBEC, H3B4M4

TRADEMARK DETAILS

HIGH PERFORMANCE IDENTITY

Trademark Type

Standard Characters

Services

Class 42

Uniform design services, in the nature of clothing design, for others; website design services for others.

Application Number 2,094,696
International Registration Number 1582833
Language of Application English

Filing Date 2021-02-16

APPLICANT DETAILS

Applicant

Esturiones Del Rio Negro S.A.
Of. 102, Tomás Basañez 1211
C.P.11300 Montevideo
URUGUAY

TRADEMARK DETAILS

BLACK RIVER CAVIAR

Trademark Type

Standard Characters

Goods

Class 29

Caviar; fish meat, namely, fresh and smoked sturgeon meat.

Claims

Priority Filing Date: August 18, 2020, Country or Office: UNITED STATES OF AMERICA,
Application No: 90120747 in association with the same kind of goods

Application Number 2,094,705
International Registration Number 1583313
Language of Application English

Filing Date 2021-02-17

APPLICANT AND AGENT DETAILS

Applicant

Magnifi U, Inc.
6 North Main Street, Suite 235
Fairport NY 14450
UNITED STATES OF AMERICA

Agent

MILLER THOMSON LLP
SCOTIA PLAZA, 40 KING STREET WEST,
SUITE 5800, P.O. BOX 1011, TORONTO,
ONTARIO, M5H3S1

TRADEMARK DETAILS

MAGNIFIU

Trademark Type

Standard Characters

Goods

Class 09

Downloadable computer software featuring a digital teaching and learning platform for use in the field of leadership development.

Services

Class 42

Platform as a service (PAAS) featuring a computer software online learning platform for providing access to instructional course content in the field of leadership development.

Claims

Priority Filing Date: August 31, 2020, Country or Office: UNITED STATES OF AMERICA,
Application No: 90148639 in association with the same kind of goods and in association with the same kind of services

Application Number 2,094,710
International Registration Number 1582856
Language of Application English

Filing Date 2021-02-17

APPLICANT AND AGENT DETAILS

Applicant

CID Resources, Inc.
601 S. Royal Lane, Suite 100
Coppell TX 75019
UNITED STATES OF AMERICA

Agent

LAVERY, DE BILLY, LLP
1 Place Ville Marie, Suite 4000, Montréal,
QUEBEC, H3B4M4

TRADEMARK DETAILS

WONDERFLEX

Trademark Type

Standard Characters

Goods

Class 10

(1) Medical wearing apparel, namely, surgical scrub tops and bottoms; medical wearing apparel, namely, surgical pants for emergency medical personnel.

Class 25

(2) Nurse's apparel, namely, tops and bottoms, uniforms, lab coats, knit tees, t-shirts, jackets, pants, cargo pants, tank tops; scrub tops and bottoms not for surgical purposes.

Application Number 2,094,715
International Registration Number 1583095
Language of Application English

Filing Date 2021-02-18

APPLICANT DETAILS

Applicant

PHITONEX, Inc.
701 West Main St., Suite 200
Durham NC 27701
UNITED STATES OF AMERICA

TRADEMARK DETAILS

NOVAFLUOR

Trademark Type

Standard Characters

Goods

Class 01

Fluorescent dyes for scientific and research use.

Application Number 2,094,721
International Registration Number 1583234
Language of Application English

Filing Date 2021-02-19

APPLICANT DETAILS

Applicant

Mischievous LLC
1 Grandview Avenue
Cornwall on Hudson NY 12520
UNITED STATES OF AMERICA

TRADEMARK DETAILS

HEATHROW

Trademark Type

Standard Characters

Goods

Class 18

Luggage; backpacks; briefcases and attache cases; train cases.

Application Number 2,094,723
International Registration Number 1583092
Language of Application English

Filing Date 2021-02-19

APPLICANT DETAILS

Applicant

JJ Acquisition, LLC
8501 Fallbrook Avenue, #370
West Hills CA 91304
UNITED STATES OF AMERICA

TRADEMARK DETAILS

ERSA

Trademark Type

Standard Characters

Goods

Class 10

Sexual aids, namely, anal plugs; sex toys.

Claims

Priority Filing Date: August 21, 2020, Country or Office: UNITED STATES OF AMERICA,
Application No: 90129699 in association with the same kind of goods

Application Number 2,094,724
International Registration Number 1583063
Language of Application English

Filing Date 2021-02-19

APPLICANT DETAILS

Applicant

JJ Acquisition, LLC
8501 Fallbrook Avenue, #370
West Hills CA 91304
UNITED STATES OF AMERICA

TRADEMARK DETAILS

KORE

Trademark Type

Standard Characters

Goods

Class 10

Sexual aids, namely, cock rings; sex toys.

Claims

Priority Filing Date: August 21, 2020, Country or Office: UNITED STATES OF AMERICA,
Application No: 90129715 in association with the same kind of goods

Application Number 2,094,725
International Registration Number 1583028
Language of Application English

Filing Date 2021-02-19

APPLICANT DETAILS

Applicant

JJ Acquisition, LLC
8501 Fallbrook Avenue, #370
West Hills CA 91304
UNITED STATES OF AMERICA

TRADEMARK DETAILS

DEIMOS

Trademark Type

Standard Characters

Goods

Class 10

Sexual aids, namely, cock rings; sex toys.

Claims

Priority Filing Date: August 21, 2020, Country or Office: UNITED STATES OF AMERICA,
Application No: 90129737 in association with the same kind of goods

Application Number 2,094,726
International Registration Number 1583011
Language of Application English

Filing Date 2021-02-19

APPLICANT DETAILS

Applicant

The Oncor Corporation
10420 Pioneer Boulevard
Santa Fe Springs CA 90670
UNITED STATES OF AMERICA

TRADEMARK DETAILS

DMK MD

Trademark Type

Standard Characters

Disclaimer

The right to the exclusive use of the word "MD" is disclaimed apart from the trademark.

Goods

Class 03

(1) Cosmetic preparations for skin care; non-medicated skin care preparations for treatment of hyperpigmentation.

Class 10

(2) Occlusive masks for medical purposes, namely therapeutic facial masks.

Claims

Priority Filing Date: August 25, 2020, Country or Office: UNITED STATES OF AMERICA,
Application No: 90136327 in association with the same kind of goods

Application Number 2,094,727
International Registration Number 1582878
Language of Application English

Filing Date 2021-02-19

APPLICANT AND AGENT DETAILS

Applicant

Fenty Skin LLC
425 Market Street, 19th Floor
San Francisco CA 94105
UNITED STATES OF AMERICA

Agent

OSLER, HOSKIN & HARCOURT LLP
SUITE 6200, P.O. BOX 50, 1 FIRST
CANADIAN PLACE, TORONTO, ONTARIO,
M5X1B8

TRADEMARK DETAILS

PRE-SHOW GLOW

Trademark Type

Standard Characters

Goods

Class 03

Non-medicated skin care preparations.

Claims

Priority Filing Date: August 27, 2020, Country or Office: UNITED STATES OF AMERICA,
Application No: 90142790 in association with the same kind of goods

Application Number 2,094,737
International Registration Number 1582974
Language of Application English

Filing Date 2021-02-24

APPLICANT DETAILS

Applicant

Titania Sea OU.
Uue-Semeri
EE-66298 Tindi kula, Rouge vald
ESTONIA

TRADEMARK DETAILS

Trademark Type

Design

Visual Representation



Goods

Class 29

Frozen fish; frozen seafood.

Claims

Priority Filing Date: October 12, 2020, Country or Office: EUIPO (EU), Application No: 018320145
in association with the same kind of goods

Application Number 2,094,761
International Registration Number 1583339
Language of Application English

Filing Date 2021-03-05

APPLICANT DETAILS

Applicant

Expense Check Pty Ltd
36/38 Gipps Street
COLLINGWOOD VIC 3066
AUSTRALIA

TRADEMARK DETAILS

KANOPI

Trademark Type

Standard Characters

Services

Class 36

Insurance brokerage and agency services.

Claims

Priority Filing Date: September 17, 2020, Country or Office: AUSTRALIA, Application No: 2121307
in association with the same kind of services

Application Number 2,094,763
International Registration Number 1583221
Language of Application English

Filing Date 2021-03-05

APPLICANT DETAILS

Applicant

Taylor's Wines Pty Limited
Shed 72, 4F Huntley Street
Alexandria NSW 2015
AUSTRALIA

TRADEMARK DETAILS

MASTERSTROKE

Trademark Type

Standard Characters

Goods

Class 33

Wines

Claims

Priority Filing Date: September 08, 2020, Country or Office: AUSTRALIA, Application No: 2118310
in association with the same kind of goods

Application Number 2,096,187
International Registration Number 1584227
Language of Application English

Filing Date 2020-06-30

APPLICANT AND AGENT DETAILS

Applicant

Speartip, LLC
refer notices to Riezman Berger,
1714 Deer Tracks Trail #150
Saint Louis MO 63131
UNITED STATES OF AMERICA

Agent

ERIN MCEWEN
Nelligan O'Brien Payne LLP, 50 O'Connor
Street, Suite 300, Ottawa, ONTARIO, K1P6L2

TRADEMARK DETAILS

SPEARTIP

Trademark Type

Standard Characters

Services

Class 42

Monitoring of computer systems for detecting unauthorized access or data breach; provision of systems for the management of computer and network threats, namely, providing on-line non-downloadable software for surveillance and monitoring of vulnerability and security problems in computer hardware, networks, and software; computer security consultancy services, namely, implementing plans for improving computer and network security and preventing criminal activity for businesses and governmental agencies.

Claims

Priority Filing Date: December 31, 2019, Country or Office: UNITED STATES OF AMERICA,
Application No: 88743089 in association with the same kind of services

Application Number 2,096,258
International Registration Number 1583599
Language of Application French

Filing Date 2020-11-09

APPLICANT DETAILS

Applicant

Jörg Kistner; Julia Kistner
Rebacherstrasse 28
CH-8955 Oetwil an der Limmat
SUISSE

TRADEMARK DETAILS

KitchenCover

Trademark Type

Standard Characters

Goods

Class 11

Flame-retardant and non-flammable covers made of fiberglass fabric specially adapted to cooktops for protection against dirt.

Claims

Priority Filing Date: June 15, 2020, Country or Office: SWITZERLAND, Application No: 754245 in association with the same kind of goods

Application Number 2,096,290
International Registration Number 1583612
Language of Application English

Filing Date 2020-11-27

APPLICANT DETAILS

Applicant
SHENZHEN CAPITAL GROUP CO., LTD.
Zone B, F11, Investment Building,
No.4009 Shennan Road,
Futian District, Shenzhen
Guangdong
CHINA

TRADEMARK DETAILS

Trademark Type
Design

Visual Representation

SCGC

Services

Class 36

Capital investment; capital investment advisory; capital investment services; investment of funds; private equity fund investment services; venture capital funding.

Application Number 2,096,422
International Registration Number 1584099
Language of Application French

Filing Date 2021-01-26

APPLICANT AND AGENT DETAILS

Applicant
GUERLAIN
68 avenue des Champs Elysées
F-75008 Paris
FRANCE

Agent
BERESKIN & PARR LLP/S.E.N.C.R.L., S.R.L.
SCOTIA PLAZA, 40 KING STREET WEST,
40th FLOOR, TORONTO, ONTARIO, M5H3Y2

TRADEMARK DETAILS

VIVRE PLUSIEURS VIES EN BEAUTÉ

Trademark Type
Standard Characters

Goods

Class 03

Cosmetics for skin, body, face, nail and hair care; creams, milks, lotions, gels and powders for non-medical use for the face, body and hands.

Claims

Priority Filing Date: July 27, 2020, Country or Office: FRANCE, Application No: 4669918 in association with the same kind of goods

Application Number 2,096,443
International Registration Number 1584516
Language of Application French

Filing Date 2021-01-29

APPLICANT DETAILS

Applicant

NICOLAS François-Xavier
ZAC des Crémades,
400 rue du Portugal
F-84100 Orange
FRANCE

TRADEMARK DETAILS

LE JARDIN DES PAPES

Trademark Type

Standard Characters

Foreign Character Translation

THE GARDEN OF THE POPES.

Goods

Class 33

Wines with the protected designation of origin "Châteauneuf-du-Pape".

Claims

Priority Filing Date: August 01, 2020, Country or Office: FRANCE, Application No: 4671539 in association with the same kind of goods

Application Number 2,096,446
International Registration Number 1584414
Language of Application English

Filing Date 2021-02-01

APPLICANT DETAILS

Applicant

Howard Park Wines Pty Ltd
PO BOX 180
North Fremantle WA 6159
AUSTRALIA

TRADEMARK DETAILS

Trademark Type

Design

Visual Representation



MAD FISH

Goods

Class 33

Wine; still wine; sparkling wine.

Claims

Priority Filing Date: September 23, 2020, Country or Office: AUSTRALIA, Application No: 2122426
in association with the same kind of goods

Application Number 2,096,448
International Registration Number 1584260
Language of Application English

Filing Date 2021-02-01

APPLICANT AND AGENT DETAILS

Applicant

Liingo Eyewear, Inc.
261 West Data Drive
Draper UT 84020
UNITED STATES OF AMERICA

Agent

SMART & BIGGAR LLP
SUITE 900, 55 METCALFE STREET, P.O.
BOX 2999, STATION D, OTTAWA, ONTARIO,
K1P5Y6

TRADEMARK DETAILS

LIINGO

Trademark Type

Standard Characters

Goods

Class 09

(1) Downloadable software application for reading, transmitting, and managing eyeglass prescriptions; eye glass cases; eye glasses; eyewear; sun glasses.

(2) Downloadable software application for reading, transmitting, and managing eyeglass prescriptions

Services

Class 42

Providing temporary use of online non-downloadable software for allowing users to virtually try on eyeglasses, eyewear, and sunglasses; providing temporary use of online non-downloadable software for measuring pupillary distance; providing temporary use of online non-downloadable software for measuring and assessing fit of eyeglasses, eyewear, and sunglasses

Claims

Priority Filing Date: August 03, 2020, Country or Office: UNITED STATES OF AMERICA, Application No: 90089362 in association with the same kind of goods (2) and in association with the same kind of services

Application Number 2,096,449
International Registration Number 1584077
Language of Application English

Filing Date 2021-02-01

APPLICANT AND AGENT DETAILS

Applicant
MONTENEGRO S.R.L.
Via Enrico Fermi 4
I-40069 ZOLA PREDOSA, BOLOGNA
ITALY

Agent
ROBIC
630, boul. René-Lévesque Ouest, 20e étage,
Montréal, QUEBEC, H3B1S6

TRADEMARK DETAILS

EDGAR SOPPER

Trademark Type
Standard Characters

Goods

Class 33

Gin.

Claims

Priority Filing Date: January 26, 2021, Country or Office: ITALY, Application No: 302021000012212 in association with the same kind of goods

Application Number 2,096,465
International Registration Number 1583381
Language of Application English

Filing Date 2021-02-02

APPLICANT DETAILS

Applicant

NKW Products, LLC
25 Stone Paddock Place
Bedford NY 10506
UNITED STATES OF AMERICA

TRADEMARK DETAILS

#NotKidFriendly

Trademark Type

Standard Characters

Goods

Class 25

Baseball caps and hats; bathing suits; hats; hats for infants, babies, toddlers and children; shirts; shirts and short-sleeved shirts; socks; stockings; sweatpants; sweatshirts; tank-tops; tank tops; athletic apparel, namely, shirts, pants, jackets, footwear, hats and caps, athletic uniforms; athletic shirts; body stockings; children's and infants' apparel, namely, jumpers, overall sleepwear, pajamas, rompers and one-piece garments; collared shirts; graphic T-shirts; hooded sweatshirts; hooded sweat shirts; knee-high stockings; night shirts; short-sleeve shirts; short-sleeved or long-sleeved t-shirts; sleep shirts; socks and stockings; sport stockings; sports shirts; sports shirts with short sleeves; T-shirts; tee shirts; tee-shirts.

Application Number 2,096,466
International Registration Number 1583374
Language of Application English

Filing Date 2021-02-02

APPLICANT DETAILS

Applicant

NKW Products, LLC
25 Stone Paddock Place
Bedford NY 10506
UNITED STATES OF AMERICA

TRADEMARK DETAILS

NKW

Trademark Type

Standard Characters

Goods

Class 25

Baseball caps and hats; bathing suits; hats; hats for infants, babies, toddlers and children; shirts; shirts and short-sleeved shirts; socks; stockings; sweatpants; sweatshirts; tank-tops; tank tops; athletic apparel, namely, shirts, pants, jackets, footwear, hats and caps, athletic uniforms; athletic shirts; body stockings; children's and infants' apparel, namely, jumpers, overall sleepwear, pajamas, rompers and one-piece garments; collared shirts; graphic T-shirts; hooded sweatshirts; hooded sweat shirts; knee-high stockings; night shirts; short-sleeve shirts; short-sleeved or long-sleeved t-shirts; sleep shirts; socks and stockings; sport stockings; sports shirts; sports shirts with short sleeves; T-shirts; tee shirts; tee-shirts.

Application Number 2,096,467
International Registration Number 1584489
Language of Application English

Filing Date 2021-02-02

APPLICANT AND AGENT DETAILS

Applicant

Apple Inc.
One Apple Park Way
Cupertino CA 95014
UNITED STATES OF AMERICA

Agent

BAKER & MCKENZIE LLP
BROOKFIELD PLACE, 181 BAY STREET,
SUITE 2100, P.O. BOX 874, TORONTO,
ONTARIO, M5J2T3

TRADEMARK DETAILS

Nevuary Radio

Trademark Type

Standard Characters

Services

Class 41

(1) Entertainment services, namely, providing an ongoing radio program and compiling and publishing music playlists in the field of urban, rap, hip hop, and pop music.

(2) entertainment services, namely providing an ongoing radio program in the field of music; production and distribution of radio programs, podcasts and sound recordings in the field of music; entertainment services, namely providing ongoing podcasts in the fields of entertainment and music; provision of information relating to music; entertainment services, namely curating songs for music playlists; entertainment services, namely compiling and publishing music playlists; providing non-downloadable customized music playlists via the internet and other communications networks; selecting non-downloadable music recordings to create musical playlists for others and publishing those musical playlists; providing a website portal featuring links to musical sound recordings; provision of live entertainment, namely, musical performances

Claims

Priority Filing Date: August 04, 2020, Country or Office: JAMAICA, Application No: 81107 in association with the same kind of services (2)

Application Number 2,096,470
International Registration Number 1583576
Language of Application English

Filing Date 2021-02-03

APPLICANT DETAILS

Applicant

Siemens Healthcare GmbH
Henkestraße 127
91052 Erlangen
GERMANY

TRADEMARK DETAILS

MAGNETOM Free

Trademark Type

Standard Characters

Goods

Class 10

Medical instruments and apparatus and parts therefor, in particular magnetic resonance imaging devices.

Claims

Priority Filing Date: August 20, 2020, Country or Office: EUIPO (EU), Application No: 018293962 in association with the same kind of goods

Application Number 2,096,482
International Registration Number 1583882
Language of Application English

Filing Date 2021-02-05

APPLICANT DETAILS

Applicant

Lifespan Integration, LLC
2014 Fir St.
Port Townsend WA 98368
UNITED STATES OF AMERICA

TRADEMARK DETAILS

LIFESPAN INTEGRATION

Trademark Type

Standard Characters

Disclaimer

The right to the exclusive use of the word "INTEGRATION" is disclaimed apart from the trademark.

Services

Class 41

Education services, namely, providing mentoring, tutoring, classes, lectures, seminars and workshops in the field of psychotherapy.

Application Number 2,096,494
International Registration Number 1583601
Language of Application English

Filing Date 2021-02-08

APPLICANT DETAILS

Applicant
MAX AND MILLER PTY LTD
210B / 3 Nagurra Place
Rozelle NSW 2039
AUSTRALIA

TRADEMARK DETAILS

Max & Miller

Trademark Type
Standard Characters

Goods

Class 09
Sunglasses.

Application Number 2,096,508
International Registration Number 1584001
Language of Application French

Filing Date 2021-02-10

APPLICANT DETAILS

Applicant

F. Hoffmann-La Roche AG
Grenzacherstrasse 124
CH-4070 Basel
SUISSE

TRADEMARK DETAILS

GOTIMU

Trademark Type

Standard Characters

Goods

Class 05

Pharmaceutical preparations for use in oncology.

Claims

Priority Filing Date: February 09, 2021, Country or Office: SWITZERLAND, Application No: 759187
in association with the same kind of goods

Application Number 2,096,516
International Registration Number 1584441
Language of Application English

Filing Date 2021-02-11

APPLICANT DETAILS

Applicant

Fifty-Six Hope Road Music Limited
Aquamarine House, Cable Beach
Nassau
BAHAMAS

TRADEMARK DETAILS

Trademark Type

Design

Visual Representation



Trademark Description

The mark consists of the term ROMARLEY in all capital letters, with the letter "O" stylized with a line through the mid-point of the "O" with the term below the image of reclining male lion in body profile facing to the right but with the head and face of the lion facing forward.

Goods

Class 30

Coffee.

Claims

Priority Filing Date: December 04, 2020, Country or Office: UNITED STATES OF AMERICA,
Application No: 90360026 in association with the same kind of goods

Application Number 2,096,524
International Registration Number 1583373
Language of Application English

Filing Date 2021-02-11

APPLICANT AND AGENT DETAILS

Applicant

Blisslights, LLC
2625 Temple Heights Drive, Unit A
Oceanside CA 92056
UNITED STATES OF AMERICA

Agent

GOWLING WLG (CANADA) LLP
1 PLACE VILLE MARIE, 37TH FLOOR/37E
ETAGE, MONTREAL, QUEBEC, H3B3P4

TRADEMARK DETAILS

ARK

Trademark Type

Standard Characters

Goods

Class 11

Laser light projector for home, personal or recreational use.

Application Number 2,096,525
International Registration Number 1584491
Language of Application English

Filing Date 2021-02-11

APPLICANT DETAILS

Applicant

Fifty-Six Hope Road Music Limited
Aquamarine House, Cable Beach
Nassau
BAHAMAS

TRADEMARK DETAILS

Trademark Type

Design

Visual Representation



Trademark Description

The mark consists of the term ROMARLEY in all capital letters, with the letter "O" stylized with a line through the mid-point of the "O" with the term below the image of reclining male lion in body profile facing to the right but with the head and face of the lion facing forward.

Services

Class 41

Night clubs; entertainment services, namely, cabarets.

Claims

Priority Filing Date: December 04, 2020, Country or Office: UNITED STATES OF AMERICA,
Application No: 90360043 in association with the same kind of services

Application Number 2,096,526
International Registration Number 1584474
Language of Application English

Filing Date 2021-02-11

APPLICANT DETAILS

Applicant

National Sleep Foundation
1010 North Glebe Road, Suite 420
Arlington VA 22201
UNITED STATES OF AMERICA

TRADEMARK DETAILS

National Sleep Foundation

Trademark Type

Standard Characters

Disclaimer

The right to the exclusive use of the word "FOUNDATION" is disclaimed apart from the trademark.

Services

Class 35

Advertising services to promote public awareness of the need for sufficient, restful sleep for individual and societal health and safety.

Application Number 2,096,528
International Registration Number 1584449
Language of Application English

Filing Date 2021-02-11

APPLICANT DETAILS

Applicant

Fifty-Six Hope Road Music Limited
Aquamarine House, Cable Beach
Nassau
BAHAMAS

TRADEMARK DETAILS

Trademark Type

Design

Visual Representation



Trademark Description

The mark consists of the term ROMARLEY in all capital letters, with the letter "O" stylized with a line through the mid-point of the "O" with the term below the image of reclining male lion in body profile facing to the right but with the head and face of the lion facing forward.

Services

Class 43

Bar services; restaurant and café services.

Claims

Priority Filing Date: December 04, 2020, Country or Office: UNITED STATES OF AMERICA,
Application No: 90360048 in association with the same kind of services

Application Number 2,096,553
International Registration Number 1584348
Language of Application English

Filing Date 2021-02-16

APPLICANT AND AGENT DETAILS

Applicant

Quadion LLC
1100 Xenium Lane North
Minneapolis MN 55441
UNITED STATES OF AMERICA

Agent

RIDOUT & MAYBEE LLP
250 University Avenue, 5th Floor, Toronto,
ONTARIO, M5H3E5

TRADEMARK DETAILS

Trademark Type

Design

Visual Representation



Trademark Description

The mark consists of the word "Quniton" with the inner circumference of the letter "Q" forming four inward protruding lobes.

Goods

Class 07

(1) Precision parts made of fluoroelastomers, namely, seals in the nature of O-rings and four-lobed sealing rings, all of the foregoing being parts of machines.

Class 17

(2) Precision parts made of fluoroelastomers, namely, seals in the nature of O-rings and four-lobed sealing rings, all of the foregoing being for industrial use.

Application Number 2,096,554
International Registration Number 1584204
Language of Application English

Filing Date 2021-02-16

APPLICANT DETAILS

Applicant

Yomali Labs Limited
The Academy, Suite 1000,
42 Pearse Street,
Dublin
D02 YX88
IRELAND

TRADEMARK DETAILS

Trademark Type

Design

Visual Representation



Trademark Description

The mark consists of the stylized letter K with the top stroke forming the K extending past the lower portion in an arc and coming to a point. The entire letter is divided into two sections by negative space between upper and lower strokes which continues through the vertical stroke.

Services

Class 42

Platform as a Service (PaaS) featuring online non-downloadable software for customer relation management (CRM), sales tracking, payment and commission processing, affiliate marketing management, product fulfillment, and customer support relating to the foregoing.

Claims

Priority Filing Date: December 31, 2020, Country or Office: UNITED STATES OF AMERICA, Application No: 90440405 in association with the same kind of services

Application Number 2,096,555
International Registration Number 1584119
Language of Application English

Filing Date 2021-02-16

APPLICANT DETAILS

Applicant

TETRAMYTHOS ABELOURGIKI
INOPIITIKIETERIA PERIORISMENIS
EFTHINIS
8o kil. Pounta-Kalavrita
GR-250 03 Ano Diakopto
GREECE

TRADEMARK DETAILS

TETRAMYTHOS

Trademark Type

Standard Characters

Goods

Class 33

Wine.

Application Number 2,096,565
International Registration Number 1584345
Language of Application English

Filing Date 2021-02-17

APPLICANT AND AGENT DETAILS

Applicant

Invaio Sciences, Inc.
75 Moulton Street
Cambridge MA 02138
UNITED STATES OF AMERICA

Agent

RIDOUT & MAYBEE LLP
250 University Avenue, 5th Floor, Toronto,
ONTARIO, M5H3E5

TRADEMARK DETAILS

GROVE OF THE FUTURE

Trademark Type

Standard Characters

Goods

Class 05

Chemical preparations for the control of insects for agricultural use, namely, immune modulating agents for insects, insect growth inhibiting agents, biocides, insecticides, acaricides, pesticides, miticides, insect growth regulators, insect fertility regulators, chemical agents for inhibiting or improving insect health, and biological agents for inhibiting or improving insect health.

Claims

Priority Filing Date: August 17, 2020, Country or Office: UNITED STATES OF AMERICA,
Application No: 90118307 in association with the same kind of goods

Application Number 2,096,639
International Registration Number 1534354
Language of Application English

Filing Date 2021-02-27

APPLICANT DETAILS

Applicant

Tug Pet Products, LLC.
Suite 287, 4441-106 Six Forks Road
Raleigh NC 27609
UNITED STATES OF AMERICA

TRADEMARK DETAILS

Trademark Type

Design

Visual Representation

The image shows the word "TUG" in a very bold, black, sans-serif font. The letters are thick and blocky, with a slightly irregular, hand-drawn appearance. The 'T' is the tallest, followed by the 'U' and then the 'G'. The 'G' has a small tail that curves slightly to the right.

Trademark Description

The mark consists of the word "TUG" in a stylized font.

Goods

Class 18

Dog leashes.

Application Number 2,096,649
International Registration Number 1487870
Language of Application English

Filing Date 2021-03-03

APPLICANT DETAILS

Applicant
Granberg AS
Bjoavegen 1442
N-5584 Bjoa
NORWAY

TRADEMARK DETAILS

POWERFIT

Trademark Type
Standard Characters

Goods

Class 09

Gloves for protection against accidents or injuries.

Application Number 2,096,651
International Registration Number 1583907
Language of Application English

Filing Date 2021-03-03

APPLICANT DETAILS

Applicant
Nokian Tyres plc
Pirkkalaistie 7
FI-37100 Nokia
FINLAND

TRADEMARK DETAILS

Nokian Tyres SilentDrive

Trademark Type
Standard Characters

Goods

Class 12

Tyres.

Claims

Priority Filing Date: September 21, 2020, Country or Office: EUIPO (EU), Application No: 018311407 in association with the same kind of goods

Application Number 2,096,652
International Registration Number 1583613
Language of Application English

Filing Date 2021-03-03

APPLICANT DETAILS

Applicant

Grip Star Australia Pty Ltd
Unit 4/5 Ace Cres
Tuggerah 2259
AUSTRALIA

TRADEMARK DETAILS

Grip Star

Trademark Type

Standard Characters

Goods

Class 25

Bed socks; footless socks; slipper socks; socks; sports socks.

Application Number 2,096,668
International Registration Number 0514495
Language of Application French

Filing Date 2021-03-08

APPLICANT DETAILS

Applicant

Egetürk Wurst- und Fleischwarenfabrikation
GmbH & Co. KG
Feldkasselerweg 5
50769 Cologne
ALLEMAGNE

TRADEMARK DETAILS

Trademark Type

Design

Visual Representation

EGETÜRK

Goods

Class 29

Meat, sausages, poultry; canned meat, sausages.

Application Number 2,098,071
International Registration Number 1585013
Language of Application English

Filing Date 2021-02-16

APPLICANT AND AGENT DETAILS

Applicant

Quadion LLC
1100 Xenium Lane North
Minneapolis MN 55441
UNITED STATES OF AMERICA

Agent

RIDOUT & MAYBEE LLP
250 University Avenue, 5th Floor, Toronto,
ONTARIO, M5H3E5

TRADEMARK DETAILS

QUNITON

Trademark Type

Standard Characters

Goods

Class 07

(1) Precision parts made of fluoroelastomers, namely, seals in the nature of O-rings and four-lobed sealing rings, all of the foregoing being parts of machines.

Class 17

(2) Precision parts made of fluoroelastomers, namely, seals in the nature of O-rings and four-lobed sealing rings, all of the foregoing being for industrial use.

Application Number 2,100,026
Language of Application French

Filing Date 2021-04-14

APPLICANT AND AGENT DETAILS

Applicant

FROMAGERIE BERGERON INC.
3837 Rte Marie-Victorin
Saint-Antoine-de-Tilly
QUÉBEC
G0S2C0

Agent

STEPHANE LAMONDE
(O'BRIEN AVOCATS), 140 GRANDE-ALLEE
EST, BUREAU 600, QUEBEC, QUÉBEC,
G1R5M8

TRADEMARK DETAILS

Trademark Type

Design

Visual Representation

PATTE BLANCHE

Goods

Class 29

cheese

Application Number 2,100,754
Language of Application English

Filing Date 2021-04-19

APPLICANT AND AGENT DETAILS

Applicant

Netflix Studios, LLC
5808 W. Sunset Blvd.
Los Angeles, CA 90028
UNITED STATES OF AMERICA

Agent

CLARK WILSON LLP
900 - 885 WEST GEORGIA STREET,
VANCOUVER, BRITISH COLUMBIA, V6C3H1

TRADEMARK DETAILS

FLORIDA MAN

Trademark Type

Standard Characters

Services

Class 41

Entertainment services in the nature of a comedic drama television series; providing online non-downloadable video clips and multimedia entertainment recordings containing audio files, video files, artwork, and informational text from and related to a comedic drama television series

Application Number 2,101,484
International Registration Number 1587802
Language of Application English

Filing Date 2021-02-03

APPLICANT DETAILS

Applicant

Siemens Healthcare GmbH
Henkestraße 127
91052 Erlangen
GERMANY

TRADEMARK DETAILS

MAGNETOM Free.Max

Trademark Type

Standard Characters

Goods

Class 10

Medical instruments and apparatus and parts therefor, in particular magnetic resonance imaging devices.

Claims

Priority Filing Date: August 20, 2020, Country or Office: EUIPO (EU), Application No: 018294204 in association with the same kind of goods

Application Number 2,101,485
International Registration Number 1587821
Language of Application English

Filing Date 2021-02-03

APPLICANT DETAILS

Applicant

Siemens Healthcare GmbH
Henkestraße 127
91052 Erlangen
GERMANY

TRADEMARK DETAILS

MAGNETOM Free.Star

Trademark Type

Standard Characters

Goods

Class 10

Medical instruments and apparatus and parts therefor, in particular magnetic resonance imaging devices.

Claims

Priority Filing Date: August 20, 2020, Country or Office: EUIPO (EU), Application No: 018294203
in association with the same kind of goods

Application Number 2,101,493
International Registration Number 1587408
Language of Application French

Filing Date 2021-02-08

APPLICANT AND AGENT DETAILS

Applicant

Arxada AG
Lonzastrasse 2
CH-3930 Visp
SUISSE

Agent

BERESKIN & PARR LLP/S.E.N.C.R.L., S.R.L.
SCOTIA PLAZA, 40 KING STREET WEST,
40th FLOOR, TORONTO, ONTARIO, M5H3Y2

TRADEMARK DETAILS

PRIMACURE

Trademark Type

Standard Characters

Goods

Class 01

Aromatic diamines as chain extenders or hardeners for polyurethanes, polyureas and epoxy resins for aerospace, automotive and industrial applications.

Claims

Priority Filing Date: January 26, 2021, Country or Office: SWITZERLAND, Application No: 759068 in association with the same kind of goods

Application Number 2,104,347
Language of Application English

Filing Date 2021-05-04

APPLICANT DETAILS

Applicant

eko technologies canada inc.
216-7250 Keele St
Concord
ONTARIO
L4K1Z8

TRADEMARK DETAILS

eko jet wave

Trademark Type

Standard Characters

Goods

Class 11

bidets; toilet seats

Application Number 2,104,348
Language of Application English

Filing Date 2021-05-04

APPLICANT DETAILS

Applicant

eko technologies Canada Inc.
216-7250 Keele St
Concord
ONTARIO
L4K1Z8

TRADEMARK DETAILS

eko microjet

Trademark Type

Standard Characters

Goods

Class 11

bidet taps; bidets; taps for bidets

Application Number 2,106,685
International Registration Number 1590913
Language of Application English

Filing Date 2021-03-15

APPLICANT DETAILS

Applicant
YAMAHA HATSUDOKI KABUSHIKI KAISHA
2500 Shingai, Iwata-shi
Shizuoka-ken 438-8501
JAPAN

TRADEMARK DETAILS

AeroSCO

Trademark Type
Standard Characters

Goods

Class 07

Outboard motors and parts and fittings thereof.

Claims

Priority Filing Date: February 26, 2021, Country or Office: JAPAN, Application No: 2021-022948 in association with the same kind of goods

Application Number 2,107,864
Language of Application English

Filing Date 2021-05-18

APPLICANT AND AGENT DETAILS

Applicant

Netflix Studios, LLC
5808 W. Sunset Blvd.
Los Angeles, CA 90028
UNITED STATES OF AMERICA

Agent

CLARK WILSON LLP
900 - 885 WEST GEORGIA STREET,
VANCOUVER, BRITISH COLUMBIA, V6C3H1

TRADEMARK DETAILS

GOD'S FAVORITE IDIOT

Trademark Type

Standard Characters

Services

Class 41

Entertainment services in the nature of a comedic drama television series; providing online non-downloadable video clips and multimedia entertainment recordings containing audio files, video files, artwork, and informational text from and related to a comedic drama television series

Claims

Priority Filing Date: November 30, 2020, Country or Office: UNITED STATES OF AMERICA, Application No: 90348713 in association with the same kind of services

Application Number 2,110,720
Language of Application French

Filing Date 2021-05-31

APPLICANT AND AGENT DETAILS

Applicant

Mr. Sunshine (Lord Guzzo) Corporation Inc.
1055 chemin du Côteau
Terrebonne
QUÉBEC
J6W5Y8

Agent

ROBIC
630, boul. René-Lévesque Ouest, 20e étage,
Montréal, QUÉBEC, H3B1S6

TRADEMARK DETAILS

LITTLE MS SUNSHINE ROSSELLA GUZZO

Trademark Type

Standard Characters

Goods

Class 29

(1) Potato chips, plantain chips, fruit chips, vegetable chips, nut-based snacks, salted nuts, fruit-based snacks.

Class 30

(2) Popcorn, candy, chocolate bars, chocolates, chocolate bites, fruit jelly candy, gummy candy, sweets, snack mixes consisting of crackers, pretzels and popcorn, chocolate-covered nuts, chocolate-based snack foods, frozen desserts and cakes, ice desserts.

Application Number 2,110,723
Language of Application French

Filing Date 2021-05-31

APPLICANT AND AGENT DETAILS

Applicant

Mr. Sunshine (Lord Guzzo) Corporation Inc.
1055 chemin du Côteau
Terrebonne
QUÉBEC
J6W5Y8

Agent

ROBIC
630, boul. René-Lévesque Ouest, 20e étage,
Montréal, QUÉBEC, H3B1S6

TRADEMARK DETAILS

Trademark Type

Design

Visual Representation



Colour Claim

Colour is claimed as a feature of the trademark. The words LITTLE and ROSSELLA GUZZO are pink. The words MS SUNSHINE are black. The dot on the "i" in the word SUNSHINE is represented by a flower with yellow petals and a black centre.

Goods

Class 29

(1) Potato chips, plantain chips, fruit chips, vegetable chips, nut-based snacks, salted nuts, fruit-based snacks.

Class 30

(2) Popcorn, candy, chocolate bars, chocolates, chocolate bites, fruit jelly candy, gummy candy, sweets, snack mixes consisting of crackers, pretzels and popcorn, chocolate-covered nuts, chocolate-based snack foods, frozen desserts and cakes, ice desserts.

Application Number 2,110,858
Language of Application English

Filing Date 2021-06-01

APPLICANT AND AGENT DETAILS

Applicant

Top 2 Merchandise Inc.
3780 14th Ave Unit 104
Markham
ONTARIO
L3R9Y5

Agent

MARK W. TIMMIS
(MARK TIMMIS LAW CORPORATION), 2595
CAVENDISH AVENUE, VICTORIA, BRITISH
COLUMBIA, V8R2G5

TRADEMARK DETAILS

Cooler Power

Trademark Type

Standard Characters

Goods

Class 09

cases for diskettes and compact disks; central processing unit [CPU] coolers; computer cables; computer carrying cases; computer heat sinks; computer keyboards; computer mouse; computer mouse mats; computer mouse pads; computer network adapters; computer network hubs; computer networking hardware; computer power supplies; computers; computers and computer hardware; disk drives for computers; electricity meters; electronic control circuits for electric fans; electronic control circuits for electric heaters; electronic control gears [ECGs] for LED lamps and light fixtures; electronic controllers for furnaces; electronic speed controllers; headsets for use with computers; heat sinks for use in computers; high-frequency switching power supplies; internal cooling fans for computers; uninterruptible power supplies

Application Number 2,114,003
Language of Application English

Filing Date 2021-06-15

APPLICANT AND AGENT DETAILS

Applicant

SHENZHEN CHUJIN NETWORK
TECHNOLOGY CO.,LTD
301(305), Bldg 3, TOD Tech Center, Lipu Rd 7
Dafapu shequ, Bantian St., Longgang Dist.
Shenzhen, 518100
CHINA

Agent

XIN XU
(JONES & CO.), 67 Yonge Street, Suite 602,
TORONTO, ONTARIO, M5E1J8

TRADEMARK DETAILS

BOLORAMO

Trademark Type

Standard Characters

Goods

Class 21

bathroom pails; bowls; bread bins; carpet sweepers; ceramic jugs; ceramic mugs; cleaning cloth; cleaning mitts; clothes pegs; cloths for cleaning; crumb-sweepers; dishwashing brushes; electrical toothbrushes; flower-pot covers; garbage cans; gardening gloves; gloves for household purposes; indoor terrariums for plants; ironing boards; kitchen mitts; lazy susans; mops; perfume burners; sprinklers for watering flowers and plants; syringes for watering flowers and plants; tea caddies; tea-caddies; tie presses; toilet paper dispensers; toilet paper holders; vases; washing boards; water bottles; window boxes

Application Number 2,114,004
Language of Application English

Filing Date 2021-06-15

APPLICANT AND AGENT DETAILS

Applicant

SHENZHEN CHUJIN NETWORK
TECHNOLOGY CO.,LTD
301(305), Bldg 3, TOD Tech Center, Lipu Rd 7
Dafapu shequ, Bantian St., Longgang Dist.
Shenzhen, 518100
CHINA

Agent

XIN XU
(JONES & CO.), 67 Yonge Street, Suite 602,
TORONTO, ONTARIO, M5E1J8

TRADEMARK DETAILS

CUTULAMO

Trademark Type

Standard Characters

Goods

Class 21

bathroom pails; bowls; bread bins; carpet sweepers; ceramic jugs; ceramic mugs; cleaning cloth; cleaning mitts; clothes pegs; cloths for cleaning; crumb-sweepers; dishwashing brushes; electrical toothbrushes; flower-pot covers; garbage cans; gardening gloves; gloves for household purposes; indoor terrariums for plants; ironing boards; kitchen mitts; lazy susans; mops; perfume burners; sprinklers for watering flowers and plants; syringes for watering flowers and plants; tea caddies; tea-caddies; tie presses; toilet paper dispensers; toilet paper holders; vases; washing boards; water bottles; window boxes

Application Number 2,116,592
International Registration Number 1597872
Language of Application English

Filing Date 2021-05-19

APPLICANT AND AGENT DETAILS

Applicant

Neuroderm LTD
3 Pekeris Street
7670212 Rehovot
ISRAEL

Agent

BENNETT JONES LLP
SUITE 3400, ONE FIRST CANADIAN PLACE,
P.O. BOX 130, TORONTO, ONTARIO,
M5X1A4

TRADEMARK DETAILS

TWEEKO

Trademark Type

Standard Characters

Goods

Class 10

Medical devices, namely, infusion pumps for the subcutaneous delivery of drugs.

Claims

Priority Filing Date: May 18, 2021, Country or Office: ISRAEL, Application No: 339468 in association with the same kind of goods

Application Number 2,116,594
International Registration Number 1597763
Language of Application English

Filing Date 2021-05-19

APPLICANT AND AGENT DETAILS

Applicant

Neuroderm LTD
3 Pekeris Street
7670212 Rehovot
ISRAEL

Agent

BENNETT JONES LLP
SUITE 3400, ONE FIRST CANADIAN PLACE,
P.O. BOX 130, TORONTO, ONTARIO,
M5X1A4

TRADEMARK DETAILS

JUBEE

Trademark Type

Standard Characters

Goods

Class 10

Medical devices, namely, infusion pumps for the subcutaneous delivery of drugs.

Claims

Priority Filing Date: May 18, 2021, Country or Office: ISRAEL, Application No: 334150 in association with the same kind of goods

Application Number 2,117,429
Language of Application English

Filing Date 2021-06-29

APPLICANT DETAILS

Applicant

eko technologies Canada Inc.
216-7250 Keele St
Concord
ONTARIO
L4K1Z8

TRADEMARK DETAILS

eko slimjet

Trademark Type

Standard Characters

Goods

Class 11

bidets

Application Number 2,118,834
Language of Application English

Filing Date 2021-07-06

APPLICANT AND AGENT DETAILS

Applicant

Shenzhen Famulei E-commerce Co.,Ltd

Rm 504, Dongsifang No.88, Baishi Street
Shahe Street
Nanshan District
Shenzhen, Guangdong,
CHINA

Agent

JERRY CHEN

166 Berwick Cres, Richmond Hill, ONTARIO,
L4C0B4

TRADEMARK DETAILS

Famulily

Trademark Type

Standard Characters

Goods

Class 24

bath linen; bath towels; bed blankets; bed covers; bed linen; bed quilts; bed sheet sets; bed spreads; cloth towels; cotton towels; face towels of textiles; felt and non-woven textile fabrics; felt cloth; hand towels; handkerchiefs of textile; individual place mats made of textile; kitchen linen; kitchen towels of textile; large bath towels; linen cloth; pillow cases; pillow shams; place mats of textile; quilts of textile; quilts of towel; sheets; table cloths of textile; textile fabrics; textile napkins; towels of textile; woven felt

Application Number 2,123,124
Language of Application English

Filing Date 2021-07-27

APPLICANT AND AGENT DETAILS

Applicant

VOLCANOES-ELECTRONICS. CO., LTD.
3335 WHITE CLOUD DRIVE
HACIENDA HIEGHTS
LOS ANGELES, CA 91745
UNITED STATES OF AMERICA

Agent

JERRY CHEN
166 Berwick Cres, Richmond Hill, ONTARIO,
L4C0B4

TRADEMARK DETAILS

INNERNEED

Trademark Type

Standard Characters

Goods

Class 21

Hair brushes; Toilet brushes; Toothbrushes; clothes brushes; cosmetic brushes; household scrubbing brushes; Ship-scrubbing brushes; Dishwashing brushes; Glove stretchers; gloves for household purposes; Abrasive sponges for scrubbing the skin; cloths for cleaning; exfoliating brushes; make-up sponges; facial cleansing sponges; kitchen cleaning sponges; scouring sponges; all purpose scouring sponges; bath sponges

Application Number 2,130,175
Language of Application English

Filing Date 2021-08-30

APPLICANT AND AGENT DETAILS

Applicant

Cheng Z Li
1819 Flushing Ave, Suite #8 Ridgewood
New York, NY 11385
UNITED STATES OF AMERICA

Agent

JERRY CHEN
166 Berwick Cres, Richmond Hill, ONTARIO,
L4C0B4

TRADEMARK DETAILS

AmeriTop

Trademark Type

Standard Characters

Goods

Class 11

- (1) desk lamps; led light bulbs; lighting fixtures
- (2) solar garden lights; security sensor lights.

Application Number 2,132,680
Language of Application English

Filing Date 2021-09-10

APPLICANT DETAILS

Applicant

Shenzhen Xiaowei Technology Co.,Ltd.
401, No.1, Lane No.7, Linggenxia, Shangmugu
Community Pinghu Street
Longgang District
Shenzhen, 518000
CHINA

TRADEMARK DETAILS

Mingnos

Trademark Type

Standard Characters

Goods

Class 09

(1) car video recorders; cases for smartphones; computer keyboards; computer mice; digital door locks; echo sounding devices; global positioning system (GPS) receivers; headsets; home cinema projectors; keyboards for mobile phones; LED displays; mobile phone chargers; protective films adapted for smartphone screens; smart glasses; smart watches; smartphones; USB chargers; wireless speakers

Class 11

(2) air humidifiers; christmas light projectors; Christmas tree lights; electric lights for christmas trees; electric night lights; fairy lights for festive decoration; head lamps; LED flashlights; led lamps; led landscape lights; led light bulbs; led luminaires; lights for bicycles; projector lamps; safety lamps; string lights for festive decoration; table lamps

Application Number 2,135,416
International Registration Number 1614265
Language of Application English

Filing Date 2021-07-23

APPLICANT DETAILS

Applicant

Liberty Procurement Co. Inc.
650 Liberty Avenue
Union NJ 07083
UNITED STATES OF AMERICA

TRADEMARK DETAILS

BRING YOUR STORY TO LIFE

Trademark Type

Standard Characters

Goods

Class 04

(1) Scented candles.

Class 05

(2) Insect repellents for humans and pets.

Class 11

(3) Lamp shades; table lamps.

Class 14

(4) Jewelry organizers.

Class 16

(5) Wall decor, namely, art pictures and prints, printed art reproductions and paintings and collages.

Class 18

(6) Bath organizers sold empty.

Class 20

(7) Bed pillows; decorative pillows.

Class 21

(8) Cocktail shakers; dinnerware, namely, plates, bowls, cups and saucers; dispensers for liquid soap; drinking cups; drinking glasses; flower pots; flower vases and bowls; mugs; napkin rings; pitchers.

Class 24

(9) Bath towels; bed blankets; curtains; table linen of textile, namely, coasters, napkins, place mats; shower curtain liners.

Class 26

(10) Artificial flower arrangements; artificial flower arrangements in containers; artificial flower wreaths.

Class 27

(11) Bath mats; bath rugs.

Class 34

(12) Matches.

Claims

Priority Filing Date: July 08, 2021, Country or Office: UNITED STATES OF AMERICA, Application No: 90817162 in association with the same kind of goods

Application Number 2,135,870
Language of Application English

Filing Date 2021-09-24

APPLICANT AND AGENT DETAILS

Applicant

Netflix Studios, LLC
5808 W. Sunset Blvd.
Los Angeles, CA 90028
UNITED STATES OF AMERICA

Agent

CLARK WILSON LLP
900 - 885 WEST GEORGIA STREET,
VANCOUVER, BRITISH COLUMBIA, V6C3H1

TRADEMARK DETAILS

FREERIDGE

Trademark Type

Standard Characters

Services

Class 41

Entertainment services in the nature of a comedic drama television series; providing online non-downloadable video clips and multimedia entertainment recordings containing audio files, video files, artwork, and informational text from and related to a comedic drama television series

Application Number 2,140,217
International Registration Number 1618987
Language of Application English

Filing Date 2021-08-31

APPLICANT DETAILS

Applicant

LegalZoom.com, Inc.
101 N. Brand Blvd., 11th Floor
Glendale CA 91203
UNITED STATES OF AMERICA

TRADEMARK DETAILS

LEGALZOOM LET'S MAKE IT OFFICIAL

Trademark Type

Standard Characters

Services

Class 45

Legal services; legal document preparation services and providing general legal information via a website on global computer networks; providing general legal information via a website on global computer networks and via attorney consultation.

Application Number 2,146,338
International Registration Number 1624924
Language of Application French

Filing Date 2021-07-07

APPLICANT DETAILS

Applicant
NOVARTIS AG
CH-4002 Basel
SUISSE

TRADEMARK DETAILS

Trademark Type
Design

Visual Representation



Goods

Class 05

Pharmaceutical preparations for the prevention and treatment of the central nervous system, namely, central nervous system infections, brain diseases, central nervous system movement disorders, ocular motility disorders, spinal cord diseases; pharmaceutical preparations for the prevention and treatment of immunological diseases, namely, autoimmune diseases, immune deficiency syndromes; pharmaceutical preparations for the prevention and treatment of cardiovascular diseases; pharmaceutical preparations for the prevention and treatment of diabetes; pharmaceutical preparations for the prevention and treatment of metabolic disorders, namely, diabetes, obesity, hyperlipidemia, insulin resistance, metabolic syndrome; anti-inflammatory; pharmaceutical preparations for the prevention and treatment of disorders of the respiratory system; pharmaceutical preparations for the prevention and treatment of disorders of the musculo-skeletal system, namely, connective tissue diseases, bone diseases, spinal diseases, back pain, fractures, sprains, cartilage injuries; pharmaceutical preparations for the prevention and treatment of genitourinary diseases, namely, urological diseases, infertility, sexually transmitted diseases, inflammatory pelvic diseases; pharmaceutical preparations for use in dermatology, namely, dermatitis, skin pigmentation diseases, sexually transmitted diseases; pharmaceutical preparations for use in oncology; pharmaceutical preparations for use in hematology, namely for the treatment of blood disorders; pharmaceutical preparations for use in tissue and organ

transplantation; pharmaceutical preparations for use in ophthalmology; pharmaceutical preparations for use in gastroenterology; pharmaceutical preparations for prevention and treatment of ocular disorders and diseases; anti-infectives, antibacterials, antivirals, antibiotics, systemic and topical antifungals.

Claims

Priority Filing Date: July 06, 2021, Country or Office: SWITZERLAND, Application No: 766320 in association with the same kind of goods

Application Number 2,146,734
Language of Application French

Filing Date 2021-11-11

APPLICANT AND AGENT DETAILS

Applicant

FROMAGERIE BERGERON INC.
3837 Rte Marie-Victorin
Saint-Antoine-de-Tilly
QUÉBEC
G0S2C0

Agent

STEPHANE LAMONDE
(O'BRIEN AVOCATS), 140 GRANDE-ALLEE
EST, BUREAU 600, QUEBEC, QUÉBEC,
G1R5M8

TRADEMARK DETAILS

Trademark Type

Design

Visual Representation

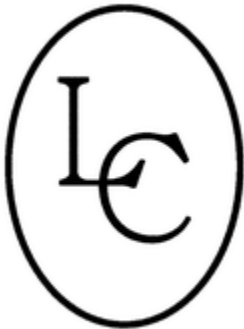

Goods

Class 29

cheese

Application Number 2,146,736
Language of Application French

Filing Date 2021-11-11

APPLICANT AND AGENT DETAILS

Applicant

FROMAGERIE BERGERON INC.
3837 Rte Marie-Victorin
Saint-Antoine-de-Tilly
QUÉBEC
G0S2C0

Agent

STEPHANE LAMONDE
(O'BRIEN AVOCATS), 140 GRANDE-ALLEE
EST, BUREAU 600, QUEBEC, QUÉBEC,
G1R5M8

TRADEMARK DETAILS

Trademark Type

Design

Visual Representation



Goods

Class 29

cheese

Application Number 2,149,199
Language of Application English

Filing Date 2021-11-23

APPLICANT DETAILS

Applicant

Bevin Chen,
Wayne Wai Yin Law
22-505 Hood Rd
Markham
ONTARIO
L3R5V6

TRADEMARK DETAILS

Trademark Type

Design

Visual Representation

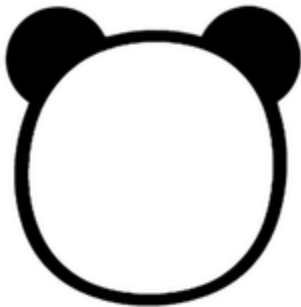

Goods

Class 09

audio speaker enclosures; audio speakers; audio/video cable connectors; audio/video cables; bags and cases specially adapted for holding or carrying portable telephones and telephone equipment and accessories; batteries for cell phones; batteries for mobile phones; battery cases; battery chargers for cell phones; battery chargers for cellular phones; beeper carrying cases; blank USB cards; blank USB flash drives; cable connectors; camcorder cases; camera cases; carrying cases for cell phones; carrying cases for cellular phones; cases adapted for cellular phones; cases adapted for mobile phones; cases for mobile phones; cell phone antennas; cell phone batteries; cell phone battery chargers; cell phone battery chargers for use in vehicles; cell phone cases; cell phone cases made of leather or imitations of leather; cell phone covers; cell phone holders; cell phone straps; cell phones; cellular phone batteries; cellular phone battery chargers for use in vehicles; cellular phone cases; cellular phone straps; cellular phones; clear protective covers adapted for cellular phones; clear protective covers adapted for mobile phones; computer keyboards; computer mouse; computer mouse mats; computer mouse pads; computer speakers;

covers for cellular phones; covers for tablet computers; digital tablets; digitizer tablets; digitizing tablets; display screen filters adapted for use with tablet computers; docking stations for cell phones; docking stations for cellular phones; docking stations for mobile phones; ear phones; earphones; earphones and headphones; flip covers for smart phones; hands free kits for phones; hands-free headsets for cellular phones; hands-free headsets for mobile phones; hands-free holders for cell phones; hands-free holders for mobile phones; hands-free kits for cellular phones; hands-free microphones for cell phones; hands-free microphones for mobile phones; headsets for cell phones; headsets for mobile phones; keyboards for cellular phones; keyboards for computers; keyboards for mobile phones; keyboards for mobile telephones; keypads for cell phones; keypads for mobile phones; lanyards for cell phones; lanyards for mobile phones; leather cases for cell phones; leather cases for mobile phones; mobile phone batteries; mobile phone chargers; mobile phone covers; mobile phone straps; mobile phones; mouse mats; mouse pads; mousepads; multifunction computer keyboards; multifunction keyboards; protective cases for cell phones; protective cases for cellular phones; protective cases for mobile phones; protective films adapted for smart phones; screen savers; smart phones; speakers for computers; stands adapted for mobile phones; straps for cellular phones; straps for mobile phones; telephone sets with screen and keyboard; USB cables for cellular phones; USB cables for mobile phones; wireless computer mice; wireless headsets for use with mobile phones; wrist rests for use with computer keyboards

Application Number 2,150,416
Language of Application English

Filing Date 2021-11-29

APPLICANT DETAILS

Applicant

MOCOR PRO PTE. LTD.
3 FRASER STREET #05-25
DUO TOWER, 189352,
SINGAPORE

TRADEMARK DETAILS

MEXC Global

Trademark Type

Standard Characters

Services

Class 36

Currency exchange, namely virtual currency exchange transaction services for transferrable electronic cash equivalent units having a specified cash value; currency exchange services; currency trading; money transfer; electronic transfer of money; currency exchange; electronic funds transfer by telecommunications; financial services, namely provision of a cryptocurrency blockchain for digital currency exchange and trading services; securities brokerage; conducting foreign exchange transactions for others; currency trading and exchange services; issuance of debit cards; financial management of digital asset services; transfer agency services for pooled funds; electronic banking via a global computer network.

Application Number 2,153,339
Language of Application English

Filing Date 2021-12-09

APPLICANT DETAILS

Applicant
ORANGE CUP OF CANADA LIMITED
3235 14th Ave
Markham
ONTARIO
L3R0H3

TRADEMARK DETAILS

REFUEL

Trademark Type
Standard Characters

Services

Class 43
coffee and juice bar services

Application Number 2,153,345
Language of Application English

Filing Date 2021-12-09

APPLICANT DETAILS

Applicant
ORANGE CUP OF CANADA LIMITED
3235 14th Ave
Markham
ONTARIO
L3R0H3

TRADEMARK DETAILS

REFUEL

Trademark Type
Standard Characters

Services

Class 43
coffee and juice bar services

Application Number 2,153,346
Language of Application English

Filing Date 2021-12-09

APPLICANT DETAILS

Applicant

Orange Cup of Canada Limited
3235 14th Ave
Markham
ONTARIO
L3R0H3

TRADEMARK DETAILS

Crave Desserts

Trademark Type

Standard Characters

Goods

Class 30

cakes

Application Number 2,158,317
International Registration Number 1637765
Language of Application English

Filing Date 2021-10-05

APPLICANT DETAILS

Applicant
KIWICO, INC.
140 East Dana Street
Mountain View CA 94041
UNITED STATES OF AMERICA

TRADEMARK DETAILS

YUMMY CRATE

Trademark Type
Standard Characters

Goods

Class 16

Children's educational kits sold as a unit in the fields of science and cooking consisting primarily of printed recipe cards, books, pamphlets, stickers, printed science experiment instructions and also including a cooking implement, being kitchen utensils and containers.

Claims

Priority Filing Date: July 09, 2021, Country or Office: UNITED STATES OF AMERICA, Application No: 90820715 in association with the same kind of goods

Application Number 2,160,405
Language of Application English

Filing Date 2022-01-14

APPLICANT AND AGENT DETAILS

Applicant

Netflix Studios, LLC
5808 W. Sunset Blvd.
Los Angeles, CA 90028
UNITED STATES OF AMERICA

Agent

CLARK WILSON LLP
900 - 885 WEST GEORGIA STREET,
VANCOUVER, BRITISH COLUMBIA, V6C3H1

TRADEMARK DETAILS

THAT '90S SHOW

Trademark Type

Standard Characters

Services

Class 41

Entertainment services in the nature of a comedic drama television series; providing online non-downloadable video clips and multimedia entertainment recordings containing audio files, video files, artwork, and informational text from and related to a comedic drama television series.

Claims

Priority Filing Date: October 08, 2021, Country or Office: JAMAICA, Application No: 084517 in association with the same kind of services

Application Number 2,163,962
International Registration Number 1641232
Language of Application English

Filing Date 2021-11-29

APPLICANT AND AGENT DETAILS

Applicant

Novavax, Inc.
21 Firstfield Road
Gaithersburg MD 20878
UNITED STATES OF AMERICA

Agent

SMART & BIGGAR LLP
1100-150 York street, TORONTO, ONTARIO,
M5H3S5

TRADEMARK DETAILS

Trademark Type

Design

Visual Representation



Goods

Class 05

Vaccines for the treatment and prevention of Covid-19

Services

Class 42

Providing medical and scientific research information in the field of Covid-19 vaccines, and clinical trials and post-market trials related to Covid-19 vaccines; consulting services in the field of research and development of Covid-19 vaccines; Covid-19 vaccine research and development

Claims

Priority Filing Date: July 06, 2021, Country or Office: UNITED STATES OF AMERICA, Application No: 90813423 in association with the same kind of services; July 06, 2021, Country or Office: UNITED STATES OF AMERICA, Application No: 90813420 in association with the same kind of goods

Application Number 2,181,174
Language of Application English

Filing Date 2022-04-22

APPLICANT AND AGENT DETAILS

Applicant
MAHOLI INC.
42 Hollinger Rd
East York
ONTARIO
M4B3G6

Agent
NADINE D'AGUIAR
Simpson Tower, 401 Bay Street, Suite 2100,
Mailbox #55, Toronto, ONTARIO, M5H2Y4

TRADEMARK DETAILS

Trademark Type
Design

Visual Representation



Goods

Class 18

(1) all-purpose carrying bags; backpacks; jewelry bags; luggage; purses; sport bags; suitcases; toiletry and cosmetic cases sold empty; tote bags; traveling bags; travelling trunks; wallets

Class 20

(2) feather beds; mattress pads; mattress toppers; neck pillows; neck support cushions; pillows

Class 24

(3) bath linen; bath sheets; bath towels; bed blankets; bed covers; bed linen; bed skirts; bed throws; blankets for children; duvet covers; duvets; pillow shams; pillowcases; sheets; table linen; tablecloths

Services

Class 35

mail order services in the field of bedding; mail order services in the field of housewares; on-line retail store services featuring tableware; on-line wholesale store services featuring tableware; online retail sale of bedding; online sale of purses and bags; online sales of housewares; retail

sale of bedding; retail sale of purses and bags; retail store and online retail store services featuring bags and luggage; retail store services featuring tableware; wholesale sale of bedding; wholesale sale of housewares; wholesale services featuring bags

Application Number 2,194,853
Language of Application English

Filing Date 2022-06-29

APPLICANT AND AGENT DETAILS

Applicant

MB Squared LLC
239 2nd Ave S
Second Floor
Saint Petersburg, FL 33701
UNITED STATES OF AMERICA

Agent

DAVID S. LIPKUS
(KESTENBERG SIEGAL LIPKUS LLP), 65
Granby Street, Toronto, ONTARIO, M5B1H8

TRADEMARK DETAILS

Risqué

Trademark Type

Standard Characters

Goods

Class 10

(1) nipple protectors

Class 26

(2) breast lift tapes; garment tapes; lingerie tapes; silicone bra pads for clothing

Application Number 2,194,941
Language of Application English

Filing Date 2022-06-29

APPLICANT AND AGENT DETAILS

Applicant

MB Squared LLC
239 2nd Ave S
Second Floor
Saint Petersburg, FL 33701
UNITED STATES OF AMERICA

Agent

DAVID S. LIPKUS
(KESTENBERG SIEGAL LIPKUS LLP), 65
Granby Street, Toronto, ONTARIO, M5B1H8

TRADEMARK DETAILS

Epic Elements

Trademark Type

Standard Characters

Goods

Class 10

(1) nipple protectors

Class 26

(2) breast lift tapes; garment tapes; lingerie tapes; silicone bra pads for clothing

Applications to extend the statement of goods or services

Application Number 1,426,536(01)
Registration Number TMA768,872
Language of Application English

Filing Date 2019-05-08

APPLICANT AND AGENT DETAILS**Applicant**

9138-4529 QUÉBEC INC.
330, rue de la Jacques-Cartier,
Victoriaville,
QUÉBEC
G6T1Y3

Agent

BROUILLETTE LEGAL INC.
1050, Côte du Beaver Hall, Bureau 1500,
MONTREAL, QUÉBEC, H2Z0A5

TRADEMARK DETAILS**Trademark Type**

Design

Visual Representation**Goods****Class 09**

Solar cells, solar recharging battery pack for digital cameras, Photovoltaic solar modules for production of electricity; Electric and electronic video surveillance installations, Electronic video surveillance products, namely, electronic components of security systems; Digital cameras, Digital video cameras, Global positioning system (GPS) navigation device ; Electronic wireless backup system comprised of microprocessor, flash card reader and radio-frequency hardware restrained into a water-resistant housing that provides an automatic recovery of data, picture or movie files between electronic equipment mostly used in hunting, wildlife and surveillance such as game camera, trail camera, scouting camera and other motion activated monitoring systems, allowing users to retrieve data wirelessly while staying away from the monitored area; Downloadable application for mobile phones and tablet computers for receiving and display meteorological data and Global Positioning System (GPS), Downloadable application for mobile phones and tablet pcs for photo storage, sorting and filing, Downloadable application for mobile phones and tablet computers for remote monitoring, operation and control of cameras mainly used in the field of hunting and wildlife, such as hunting cameras, trail cameras and other motion-activated surveillance systems that allows the user to retrieve and remotely send wireless data while staying away from the monitored area, Facial recognition software, Downloadable mobile applications using artificial intelligence for facial recognition

Application Number 1,533,791(01)
Registration Number TMA827,291
Language of Application English

Filing Date 2019-06-14

APPLICANT AND AGENT DETAILS

Applicant

LOCKERROOM MARKETING LTD.
694 Derwent Way
Delta
BRITISH COLUMBIA
V3M5P8

Agent

SMART & BIGGAR LLP
2300 - 1055 West Georgia Street, P.O. Box
11115, Vancouver, BRITISH COLUMBIA,
V6E3P3

TRADEMARK DETAILS

JUNGLE JUICE

Trademark Type

Word

Goods

Class 01

(2) Chemical compositions consisting of alkyl nitrates for use in the adult industry.

Class 03

(1) Leather cleaners.

Application Number 1,533,792(01)
Registration Number TMA827,288
Language of Application English

Filing Date 2019-06-14

APPLICANT AND AGENT DETAILS

Applicant

LOCKERROOM MARKETING LTD.
694 Derwent Way
Delta
BRITISH COLUMBIA
V3M5P8

Agent

SMART & BIGGAR LLP
2300 - 1055 West Georgia Street, P.O. Box
11115, Vancouver, BRITISH COLUMBIA,
V6E3P3

TRADEMARK DETAILS

MANSCENT

Trademark Type

Word

Goods

Class 01

(2) Chemical compositions consisting of alkyl nitrates for use in the adult industry.; Chemical compositions consisting of alkyl nitrites of use in the adult industry.

Class 03

(1) Leather cleaners.

Application Number 1,533,793(01)
Registration Number TMA827,287
Language of Application English

Filing Date 2019-06-14

APPLICANT AND AGENT DETAILS

Applicant

LOCKERROOM MARKETING LTD.
694 Derwent Way
Delta
BRITISH COLUMBIA
V3M5P8

Agent

SMART & BIGGAR LLP
2300 - 1055 West Georgia Street, P.O. Box
11115, Vancouver, BRITISH COLUMBIA,
V6E3P3

TRADEMARK DETAILS

BLUE BOY

Trademark Type

Word

Goods

Class 03

Leather cleaners.

Application Number 1,556,053(01)
Registration Number TMA1,009,684
Language of Application English

Filing Date 2019-01-18

APPLICANT AND AGENT DETAILS

Applicant

Digital Metal AB
c/o Höganäs AB
Bruksgatan 35
263 83 HÖGANÄS
SWEDEN

Agent

RIDOUT & MAYBEE LLP
250 University Avenue, 5th Floor, Toronto,
ONTARIO, M5H3E5

TRADEMARK DETAILS

DIGITAL METAL

Trademark Type

Word

Goods

Class 07

(1) Machines, namely, additive, rapid, direct, instant, laser sintering and on-demand manufacturing machines and machine tools, namely, heat treating machine tools and sintering machine tools for manufacturing of products, prototypes, models, tools, parts and components from three dimensional models of metal powder.

Class 09

(2) Scientific, photographic, cinematographic and optical apparatus and instruments, namely, cameras, computer printers, smart printers and ink jet printers for additive manufacturing; lasers for additive manufacturing; computers for preparing computer software for process control; computer software for operating system programs used in additive, rapid, direct, instant, laser sintering and on-demand manufacturing machines.

Public notices under section 9 of the *Trademarks Act*

Application Number 927,530

PROHIBITED MARK DETAILS**The Conduit**

The Registrar hereby gives public notice under subparagraph 9(1)(n)(ii) of the Trademarks Act, of the adoption and use by Ryerson University of the badge, crest, emblem or mark shown here.

Application Number 927,633

PROHIBITED MARK DETAILS

Torontomu

The Registrar hereby gives public notice under subparagraph 9(1)(n)(ii) of the Trademarks Act, of the adoption and use by RYERSON UNIVERSITY doing business as TORONTO METROPOLITAN UNIVERSITY of the badge, crest, emblem or mark shown here.

Application Number 927,707

PROHIBITED MARK DETAILS

THE IMAGE CENTRE

The Registrar hereby gives public notice under subparagraph 9(1)(n)(ii) of the Trademarks Act, of the adoption and use by RYERSON UNIVERSITY doing business as TORONTO METROPOLITAN UNIVERSITY of the badge, crest, emblem or mark shown here.

Application Number 927,708

PROHIBITED MARK DETAILS

**THE
IMAGE
CENTRE**

The Registrar hereby gives public notice under subparagraph 9(1)(n)(ii) of the Trademarks Act, of the adoption and use by RYERSON UNIVERSITY doing business as TORONTO METROPOLITAN UNIVERSITY of the badge, crest, emblem or mark shown here.

Application Number 926,579

PROHIBITED MARK DETAILS



The Registrar hereby gives public notice under subparagraph 9(1)(n)(iii) of the Trademarks Act, of the adoption and use in Canada by Municipalité de Saint-Wenceslas of the mark shown here, as an official mark for goods and services.

Description

Yellow, blue, light green, dark green and red are described as elements of the mark. The words "Municipalité de Saint-Wenceslas", the gear part and the two figures are black. The sun is yellow. There are green trees in front of the sun. There are three houses on the left of the trees. The house on the left has a red roof. The house in the middle has a blue roof. The house on the right has a red wall. A green silo is located on the right of the church. There is a red barn in front of the silo. The field in front of the barn features green and yellow stripes. The sky on the right of the sun features horizontal blue stripes. There are three maple leaves under the blue stripes. The maple leaf on the left is dark green, the maple leaf on the right is red, and the one on the bottom is light green.

Application Number 927,011

PROHIBITED MARK DETAILS

MARIOS

The Registrar hereby gives public notice under subparagraph 9(1)(n)(iii) of the Trademarks Act, of the adoption and use in Canada by Alberta Innovates of the mark shown here, as an official mark for services.

Application Number 927,299

PROHIBITED MARK DETAILS



The Registrar hereby gives public notice under subparagraph 9(1)(n)(iii) of the Trademarks Act, of the adoption and use in Canada by CITY OF REGINA of the mark shown here, as an official mark for goods and services.

Description

The colours blue, yellow, brown and white are described as an element of the mark. The Maltese cross design is blue and yellow. The coat of arms is yellow, light blue, brown and white. The fire hydrant, the ladder, and the words "REGINA", "FIRE", "PREVENTION", "PROTECTION" and "PROFESSIONALISM" are white.

Application Number 927,301

PROHIBITED MARK DETAILS



The Registrar hereby gives public notice under subparagraph 9(1)(n)(iii) of the Trademarks Act, of the adoption and use in Canada by CITY OF REGINA of the mark shown here, as an official mark for goods and services.

Description

The colours orange, yellow, red, blue and grey are described as an element of the mark. A stylized "R" transitions from the colours orange to yellow, dark blue and transitioning to light blue. The word "REGINA" appears in grey.

Application Number 927,303

PROHIBITED MARK DETAILS



The Registrar hereby gives public notice under subparagraph 9(1)(n)(iii) of the Trademarks Act, of the adoption and use in Canada by CITY OF REGINA of the mark shown here, as an official mark for goods and services.

Description

The colours white, red, orange, yellow, green, blue and purple are described as an element of the official mark. The elements "I", "R" and "I LOVE REGINA" are white and the heart design is red, orange, yellow, green, blue, and purple.

Application Number 927,547

PROHIBITED MARK DETAILS



The Registrar hereby gives public notice under subparagraph 9(1)(n)(iii) of the Trademarks Act, of the adoption and use in Canada by SASKATCHEWAN MUNICIPAL HAIL INSURANCE ASSOCIATION of the mark shown here, as an official mark for goods and services.

Description

The colours yellow and dark blue are described as an element of the official mark. The wheat sheaf design appears in yellow and the letters MHI appear in dark blue.

Application Number 927,665

PROHIBITED MARK DETAILS

ROM IMMORTAL

The Registrar hereby gives public notice under subparagraph 9(1)(n)(iii) of the Trademarks Act, of the adoption and use in Canada by THE ROYAL ONTARIO MUSEUM of the mark shown here, as an official mark for goods and services.

Application Number 927,666

PROHIBITED MARK DETAILS

ROM INTEMPOREL

The Registrar hereby gives public notice under subparagraph 9(1)(n)(iii) of the Trademarks Act, of the adoption and use in Canada by The Royal Ontario Museum of the mark shown here, as an official mark for goods and services.