

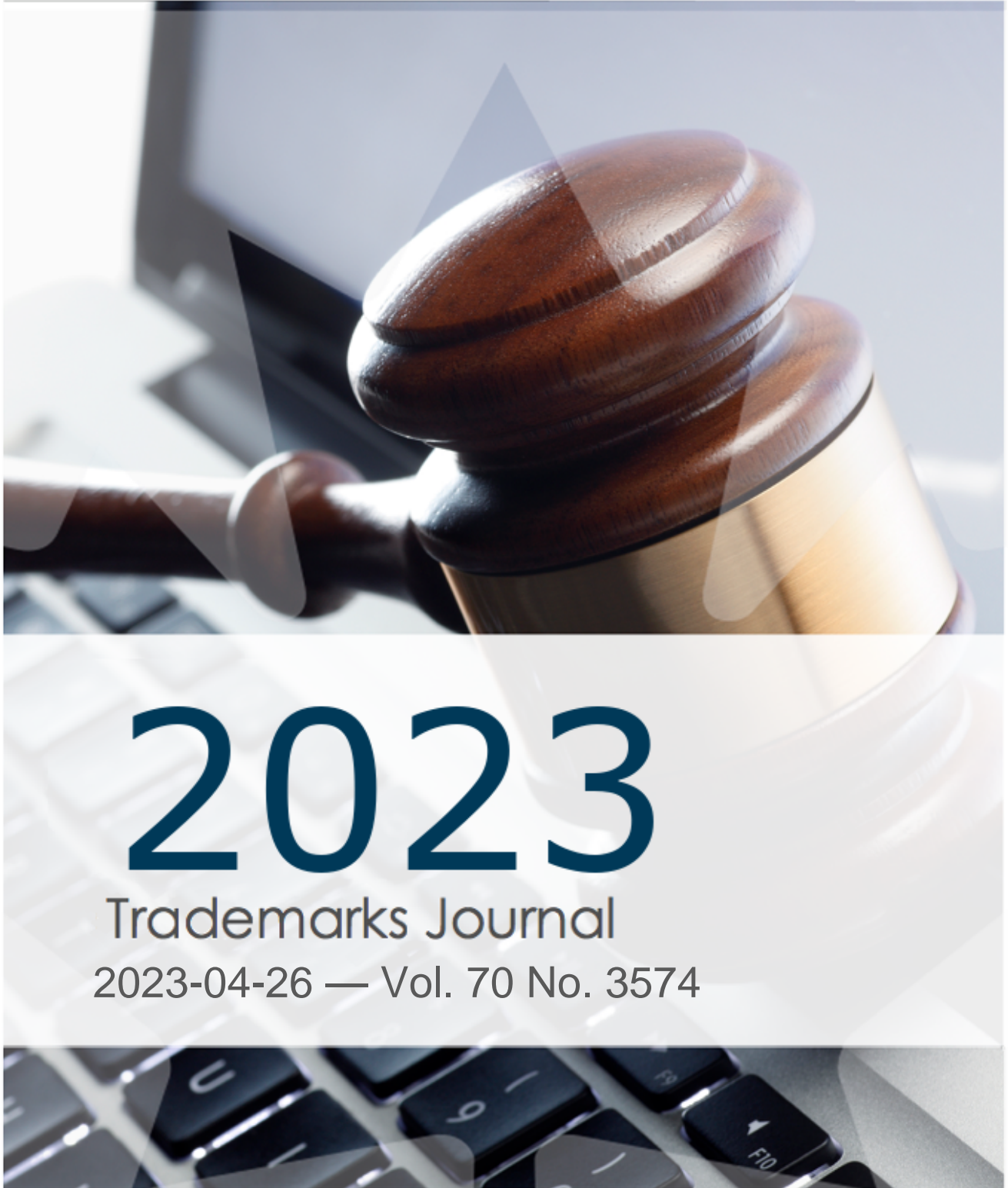

Innovation, Sciences et  
Développement économique Canada  
Office de la propriété intellectuelle du Canada

Innovation, Science and  
Economic Development Canada  
Canadian Intellectual Property Office



# 2023

## Trademarks Journal

2023-04-26 — Vol. 70 No. 3574

# Trademarks Journal

## Vol. 70 No. 3574

---

### General Information

---

The *Trademarks Journal* (the “*Journal*”) is published on the website of the Canadian Intellectual Property Office (<http://cipo.gc.ca>). The *Journal* lists trademark applications advertised under subsection 37(1) of the *Trademarks Act* (the “*Act*”), public notices of prohibited marks under section 9 of the *Act*, statements of the Minister in respect of geographical indications under subsection 11.12(2) of the *Act*, as well as erratums to previous volumes.

---

### Electronic *Trademarks Journal*

---

The *Journal* is available in PDF format and can be downloaded free of charge and viewed and printed with Adobe Acrobat Reader. The *Journal* is also available in a printable HTML format as an alternate official version that contains a search function to narrow and customize the content. The electronic form of the *Journal* is the official version.

---

### Official Languages

---

The *Journal* is available in English and French. The details displayed for each application are based on the language of the application. If the language of the application is English, the goods, services, or other text and description appearing in the English version of the *Journal* are in the language filed by the applicant. If the language of the application is French, the goods, services, or other text and description appearing in the English version of the *Journal* have been translated. Any registration resulting from the application will be restricted to these goods or services as described in the language of the application.

---

### Filing Dates

---

The filing date of each trademark application (including those to extend the statement of goods or services of an existing registration) is shown in the YYYY-MM-DD format.

---

## Nice Classification

---

Where applicable and required, the *Journal* lists the goods or services of each application grouped according to the classes of the Nice Classification, each group being preceded by the number of the class of the Nice Classification to which that group of goods or services belongs and presented in the order of the classes of the Nice Classification.

---

## Opposition

---

Any person who has a valid ground of opposition (see section 38 of the *Act* for the grounds of opposition) to any application for registration of a trademark or to any application for registration of a trademark extending the statement of goods or services advertised in this *Journal* may file a statement of opposition with the Registrar of Trademarks within two months from the date of issue of this publication. The prescribed fee must accompany the statement of opposition.

ISSN 0041-0438 (printed)

ISSN 1701-4751 (online)

---

## Table of contents

---

---

Advertised applications ..... 5

---

Applications to extend the statement of goods or services ..... 1482

---

Erratum ..... 1485

---



---

**Advertised applications**

---

**Application Number** 1,808,561  
**Language of Application** English

**Filing Date** 2016-11-09

**APPLICANT AND AGENT DETAILS****Applicant**

Gregg Distributors Co. Ltd.  
16215 - 118 Avenue NW  
Edmonton  
ALBERTA  
T5V1C7

**Agent**

GOWLING WLG (CANADA) LLP  
550 BURRARD STREET, SUITE 2300,  
VANCOUVER, BRITISH COLUMBIA, V6C2B5

**TRADEMARK DETAILS****ROUGHNECK****Trademark Type**

Standard Characters

**Goods****Class 04**

(1) Oil field drilling pipe thread spray; Cutting oils; Industrial greases; Industrial lubricants; Industrial lubricating oils; Industrial oils

**Class 17**

(2) Absorbent pads for use with oil and hazardous substances, namely, melt blown absorbent pads, laminated absorbent pads, universal glycol pads, sonic bonded absorbent pads; Booms, namely, spill containment booms; Rugs, namely spill containment rugs; Towels, namely spill containment towels

**Application Number** 1,858,439  
**Language of Application** English

**Filing Date** 2017-09-20

## APPLICANT AND AGENT DETAILS

### Applicant

Benchmark Animal Health Limited  
8 Smithy Wood Drive  
Sheffield S35 1QN  
UNITED KINGDOM

### Agent

BERESKIN & PARR LLP/S.E.N.C.R.L., S.R.L.  
SCOTIA PLAZA, 40 KING STREET WEST,  
40th FLOOR, TORONTO, ONTARIO, M5H3Y2

## TRADEMARK DETAILS

# CLEANTREAT

### Trademark Type

Word

### Goods

#### Class 11

Equipment for use in commercial salmon farming, namely water purification and filtration apparatus and filters therefor to process bath treatment water for sea lice and/or to remove contaminants.

### Services

#### Class 40

Water conditioning, purification, filtration and treatment services for the aquaculture industry, namely to process bath treatment water for sea lice and/or to remove contaminants; rental of water treatment and filtration equipment for the aquaculture industry to process bath treatment water for sea lice and/or to remove contaminants.

### Claims

Priority Filing Date: March 22, 2017, Country or Office: UNITED KINGDOM, Application No: 3220335 in association with the same kind of goods and in association with the same kind of services

**Application Number** 1,865,298  
**Language of Application** English

**Filing Date** 2017-10-30

## APPLICANT AND AGENT DETAILS

### Applicant

Town Brewery Inc.  
1632 Charles Street  
Whitby  
ONTARIO  
L1N1B9

### Agent

MILLER THOMSON LLP  
SCOTIA PLAZA, 40 KING STREET WEST,  
SUITE 5800, P.O. BOX 1011, TORONTO,  
ONTARIO, M5H3S1

## TRADEMARK DETAILS

# TOWN BREWERY

### Trademark Type

Word

### Goods

#### Class 25

(1) hats; sweaters; t-shirts

#### Class 32

(2) beer

### Services

#### Class 40

brewery services

**Application Number** 1,871,421  
**Language of Application** English

**Filing Date** 2017-12-05

## APPLICANT AND AGENT DETAILS

### Applicant

Paul Williams  
55 Ridgevale Avenue  
Halifax  
NOVA SCOTIA  
B3A3L8

### Agent

DAVID A. COPP  
12 Armshore Drive, Halifax, NOVA SCOTIA,  
B3N1M5

## TRADEMARK DETAILS

# INTERNET ESSENTIALS

### Trademark Type

Word

### Goods

#### Class 09

(1) computer software to enable secure connection to Internet service providers; computer accessories, namely, computer mouse pads; computer hardware, namely, blank USB flash drives; decorative emblems for magnetic attachment;

#### Class 20

(2) drinking glass and coffee mugs;

#### Class 21

(5) coasters for drinking glasses;

#### Class 24

(3) decorative printed emblems for self-adhesive attachment;

#### Class 25

(4) clothing, namely, caps, golf shirts and T-shirts;

### Services

#### Class 35

(1) business management consulting services concerning the Internet;

#### Class 42

(2) Internet security and computer system protection services; website development and design services.

**Application Number** 1,878,550  
**Language of Application** English

**Filing Date** 2018-01-19

## APPLICANT AND AGENT DETAILS

### Applicant

Maxar Technologies Holdings Inc.  
Suite 4025 Spear Tower  
One Market Plaza  
San Francisco, CA 94105  
UNITED STATES OF AMERICA

### Agent

SMART & BIGGAR LP  
1100-150 York street, TORONTO, ONTARIO,  
M5H3S5

## TRADEMARK DETAILS

# MAXAR

### Trademark Type

Word

### Goods

#### Class 09

(1) satellites and computer software for the operation and monitoring of the aforesaid goods; telecommunications hardware, namely, satellite and telecommunications systems comprised of satellite transmitters, satellite receivers, and computer software for the operation and monitoring of the aforesaid goods; antennas, namely, satellite antennas; satellite payload systems composed of network repeaters, transponders, microwave receivers, RF multiplexers and switches, waveguide, power amplifiers, channel processing computer hardware and automatic switching apparatus, namely, antennas, namely, satellite antennas, reflectors, diplexers, triplexers, satellite antenna feeds and feed networks, comprised of antenna feed horns, support structure and pointing mechanisms, harnesses and cables, modulators, demodulators, frequency converters and generators, interface units, satellite processors, and thermal control subsystem comprised of optical couplers and antenna filters; robots, namely, laboratory robots and computer software for the operation and monitoring of the aforesaid goods; robotics equipment, namely, acceleration, proximity, and temperature sensors, electronic computer hardware and computer anti-virus software, electronic controls for machines, structural parts for laboratory robots and replacement parts for laboratory robots sold together as a unit; robotic systems comprised of laboratory robots, robot arms, and software to operate robot and robot arms; satellite telemetry tracking and control systems comprised of satellite transmitters and receivers, and computer software for the operation and monitoring of the aforesaid goods; radar apparatus and radar systems comprised of radar detectors, signal processors, signal display screens, and signal processing and signal analysis software

#### Class 12

(2) Spacecraft, namely, space vehicles, apparatus for locomotion by air and space, namely, airborne platforms for maintenance and repair of satellites and space vehicles and structural components thereof; unmanned aerial vehicles

### Services

#### Class 35

(1) Online retail store services featuring imagery of the earth; subscription-based order fulfillment service in the field of photography and video recordings of the earth taken by aircraft and satellites; business-to business electronic retail and wholesale image provider services, namely, providing retail and wholesale store services featuring geographic and earth images captured by aircraft and satellite

#### **Class 37**

(2) Installation and maintenance of signal processors, signal display screen, radar sensors and detectors, radar apparatus and radar hardware systems and computer hardware components of satellites that are part of satellite ground systems and computer hardware for satellite ground systems, namely, satellite receiving dishes and antenna, satellite signal data processing hardware and software, video monitors, magnetic media for storage of data, electronic recording devices, radio receivers, radar sensor, radio signal transmitters, radio signal receivers, radio wave antennas, transducers, signal processors, signal display screens, radar sensors and detectors, radar apparatus and radar hardware systems

#### **Class 38**

(3) Telecommunications services, namely, electronic transmission of tracking, telemetry and control data of communication satellites for others; electronic delivery of data acquired from satellites, namely, images, photographs and maps

#### **Class 39**

(4) Treatment of materials in the nature of metals, graphite, aluminum, copper, and insulation and sealing materials in the nature of rubber, silicone, metals, plastic, and polyethylene

#### **Class 40**

(5) Treatment of materials in the nature of metals, graphite, aluminum, copper, and insulation and sealing materials in the nature of rubber, silicone, metals, plastic, and polyethylene

#### **Class 41**

(6) Digital imaging services; photography services

#### **Class 42**

(7) Engineering, design, and development of satellites, namely aerospace engineering and mechanical engineering, satellite systems and satellite components, robots, and robotic systems and robot components; space-based earth monitoring, namely, monitoring of space-based computer systems by remote access to ensure proper functioning and photography services; interpretation of digital aerial and satellite images of the earth for others for scientific and research purposes; photogrammetry services; geospatial services, namely, making maps and scale drawings from aerial and satellite photographs; computer modeling services, namely, evaluating algorithms for object detection from remotely sensed imagery of earth; software as a service (SAAS) services featuring software for receiving, collecting, displaying, processing, and analyzing data from satellites and space-based robotic systems; software as a service (SAAS) services featuring software in the field of digital imagery for use in connection with the collection, manipulation, processing, electronic formatting and distribution of aerial, geographic, and satellite imagery; software as a service (SAAS) services featuring software in the field of geospatial information and data, geocoding information, geographic information systems, satellite imagery, photogrammetry, mapping, location intelligence and location monitoring, namely, software for accessing, downloading, analyzing, searching, organizing, sharing, distributing, updating, purchasing, integrating, and monitoring imagery, geospatial information, geospatial content, and location-specific information; providing an online computer database in the field of geospatial

imagery for producing satellite imagery, namely, a historical archive of high resolution satellite imagery of a geographic location for comparison with satellite images of the same location following a natural disaster, man-made disaster or other event of high interest to provide historical context plus follow up with imagery of the geography; provision of databases of maps; providing a website featuring a database containing remotely sensed earth imagery; hosting a website software tools for manipulating, searching, filtering, annotating, bookmarking, alerting, and monitoring geospatial imagery; providing a website featuring on-line non-downloadable software tools for image editing and manipulation; providing scientific information in the fields of geospatial information and intelligence related to a database of images and geographic measurements of the earth; providing information services in the nature of satellite imagery and geographic information by the collection, manipulation, interpretation, electronic formatting and distribution of data obtained via satellite; providing information services in the fields of location intelligence and geospatial intelligence; scientific research and development and consultation related thereto in the fields of geospatial information and data, geo-coding information, geographic information systems, location intelligence, location-specific information, and location monitoring; analysis services for others, namely, analysis and integration of cartography and mapping information in the field of geospatial information and consultation related thereto; computer services in the nature of electronic imaging of aerial, geographic, and satellite images; computer services, namely, hosting a website featuring technology enabling users to conduct geographic information analysis; management of an online community of registered users, namely, hosting and maintaining a website for an online community of registered users where users utilize the website to analyze and provide information regarding satellite images of the earth; creating an online community of registered users for providing incentives for users to participate in the online community in order to utilize the website to analyze and provide information regarding satellite images of the earth; scientific advice and consultancy, namely, technology consultancy in the field of defense and military capability, command and control mission planning, computer technology, data processing, national security, aerospace, cyber security, avionics, warfare and weapons, and surveillance systems related to the foregoing

### **Claims**

Priority Filing Date: July 20, 2017, Country or Office: TONGA, Application No: TO/M/17/03415 in association with the same kind of goods and in association with the same kind of services

**Application Number** 1,892,995  
**Language of Application** English

**Filing Date** 2018-04-11

## APPLICANT AND AGENT DETAILS

### Applicant

World Wrestling Entertainment, Inc.  
1241 East Main Street  
Stamford, CT 06902  
UNITED STATES OF AMERICA

### Agent

GOWLING WLG (CANADA) LLP  
SUITE 2600, 160 ELGIN STREET, OTTAWA,  
ONTARIO, K1P1C3

## TRADEMARK DETAILS

# AJ STYLES

### Trademark Type

Word

### Authorisation For Use

Consent from Allen Neal Jones is of record.

### Goods

#### Class 03

(1) Aftershave, antiperspirants, essential oils for aromatherapy, baby lotion, bar soap, bath soap, bath oil, beauty creams, body lotion, body spray, all-purpose cleaning preparations, cologne, perfume, cosmetic preparations, namely, cosmetics, cotton balls, household detergents, eye makeup, face powder, hair care preparations, shampoo, hand lotions, hand soap, body soap, lip stick, lip gloss, lotions for face and body care, make-up for the face and body, mouthwash, nail polish, scented oils, toothpaste, all for use in conjunction with wrestling, wrestlers and wrestling sport entertainment only; cosmetics, cotton balls, household detergents, eye makeup, face powder, hair care preparations, shampoo, hand lotions, hand soap, body soap, lip stick, lip gloss, lotions for face and body care, make-up for the face and body, mouthwash, nail polish, scented oils, toothpaste, all for use in conjunction with wrestling, wrestlers and wrestling sport entertainment only; temporary tattoo transfers for use in conjunction with wrestling, wrestlers and wrestling sport entertainment only.

#### Class 07

(2) Gum machines, candy bowl mechanical dispensers, and stick gum dispensers, all for use in conjunction with wrestling, wrestlers and wrestling sport entertainment only.

#### Class 09

(3) Motion pictures in conjunction with wrestling, wrestlers and wrestling sport entertainment only; downloadable ring tones, graphics and music via a global computer network and wireless devices, namely, mobile phones, pagers, tablet computers, laptop computers, portable handheld digital music players, and personal digital assistants (PDAs) all for use in conjunction with wrestling, wrestlers and wrestling sport entertainment only; interactive video games, video games, video and computer game tapes, video and computer game discs, video and computer game cassettes, video and computer game cartridges, video and computer game CD-ROMs, video output game machines for use with televisions, video game machines and hand-held video game machines, software for playing video games and computer games, coin-fed amusement gaming machines,



interactive multimedia computer games on all platforms comprised of computer hardware and computer game software, electronic games that involve interaction with a user interface to generate visual feedback on a video device all for use in conjunction with wrestling, wrestlers and wrestling sport entertainment only; pre-recorded compact discs, pre-recorded video tapes, pre-recorded video cassette tapes and pre-recorded DVDs featuring television programs pre-recorded compact discs, prerecorded video tapes, pre-recorded video cassette tapes, pre-recorded DVDs and pre-recorded audio cassettes, all containing audio and video in the field of sports entertainment, namely, wrestling sports entertainment; videos in the field of wrestling sports entertainment; pre-recorded phonograph records, prerecorded compact discs, pre-recorded video tapes, pre-recorded video cassette tapes, pre-recorded DVDs and pre-recorded audio cassettes, all containing audio and video in the field of sports entertainment, namely, wrestling sports entertainment; decorative refrigerator magnets, mouse pads, disposable cameras all for use in conjunction with wrestling, wrestlers and wrestling sport entertainment only; sunglasses, sunglass cases, prescription eye glasses, optical cases, namely, cases for spectacles and sunglasses all for use in conjunction with wrestling, wrestlers and wrestling sport entertainment only; walkie talkies, and sports helmets, both for use in conjunction with wrestling, wrestlers and wrestling sport entertainment only; Bowling ball accessories, namely, wrist supports for use in conjunction with wrestling, wrestlers and wrestling sport entertainment only; video game cartridges and cassettes featuring wrestling, for use in conjunction with wrestling, wrestlers and wrestling sport entertainment only.

(4) Mobile phone cases for use in conjunction with wrestling, wrestlers and wrestling sport entertainment only.

#### **Class 11**

(5) Christmas lights for use in conjunction with wrestling, wrestlers and wrestling sport entertainment only.

#### **Class 12**

(6) Push, pedal, motor, and electric scooters for use in conjunction with wrestling, wrestlers and wrestling sport entertainment only.

#### **Class 14**

(7) Leather key chains for use in conjunction with wrestling, wrestlers and wrestling sport entertainment only.

(8) Pendants for use in conjunction with wrestling, wrestlers and wrestling sport entertainment only.

#### **Class 16**

(9) Paper hangtags, cardboard hangtags all for use in conjunction with wrestling, wrestlers and wrestling sport entertainment only; packaging, namely blister cards, paper for wrapping and packaging, paper pouches for packaging, plastic bags for packaging, plastic bubble packs for wrapping or packaging all for use in conjunction with wrestling, wrestlers and wrestling sport entertainment only; collector albums, namely, for sticker collectable cards, photo collectables all for use in conjunction with wrestling, wrestlers and wrestling sport entertainment only; mounted and unmounted photographs; framed pictures all for use in conjunction with wrestling, wrestlers and wrestling sport entertainment only; cardboard standups all for use in conjunction with wrestling, wrestlers and wrestling sport entertainment only; labels, namely, printed paper labels, printed shipping labels; return address labels not of textile all for use in conjunction with wrestling, wrestlers and wrestling sport entertainment only; folders, namely, file folders, stationery folders and hanging folders all for use in conjunction with wrestling, wrestlers and wrestling sport entertainment only; plastic bags for general use all for use in conjunction with wrestling, wrestlers

and wrestling sport entertainment only; paper tableware, namely, paper place mats, paper table mats, paper napkins, paper table linens, paper tablecloths all for use in conjunction with wrestling, wrestlers and wrestling sport entertainment only; paper lunch bags all for use in conjunction with wrestling, wrestlers and wrestling sport entertainment only; stickers, bumper stickers, and window decals all for use in conjunction with wrestling, wrestlers and wrestling sport entertainment only; paper book markers, pens, pencils, pencil sharpeners, pencil cases, chalk, erasers, namely, rubber erasers, chalk erasers, blackboard erasers all for use in conjunction with wrestling, wrestlers and wrestling sport entertainment only; posters, trading cards, calendars, photographs, framed picture, photographic prints, pictures, photo albums all for use in conjunction with wrestling, wrestlers and wrestling sport entertainment only; brochures, newsletters, magazines, and newspapers all for use in conjunction with wrestling, wrestlers and wrestling sport entertainment only; postcards and greeting cards both for use in conjunction with wrestling, wrestlers and wrestling sport entertainment only; coloring books, notebooks, children's activity books, souvenir and event programs relating to sports entertainment, books concerning sports entertainment, books featuring pictorial biographies, autograph books, comic books, picture books, sticker albums, book covers, and paper book markers all for use in conjunction with wrestling, wrestlers and wrestling sport entertainment only; envelopes, bookplates, note pads, memo pads, scribble pads, date books, address books, agenda books, rubber stamps, stamp pads, collector stamps (specifically excluding postage stamps), and collectible prepaid telephone cards not magnetically encoded all for use in conjunction with wrestling, wrestlers and wrestling sport entertainment only; customized personal cheques and cheque book covers both for use in conjunction with wrestling, wrestlers and wrestling sport entertainment only; paper banners and printed paper signs for doors both for use in conjunction with wrestling, wrestlers and wrestling sport entertainment only; stencils for tracing designs onto paper, drawing rulers, and lithographs all for use in conjunction with wrestling, wrestlers and wrestling sport entertainment only; indoor ornaments of paper, paper party bags, paper party favors, namely, paper hats, paper gift wrap, and paper cake decorations all for use in conjunction with wrestling, wrestlers and wrestling sport entertainment only; paper, stationery, namely, paper, and envelopes, all for use in conjunction with wrestling, wrestlers and wrestling sport entertainment only; Identification tags of paper for use in conjunction with wrestling, wrestlers and wrestling sport entertainment only; face painting sets for use in conjunction with wrestling, wrestlers and wrestling sport entertainment only.

### **Class 18**

(10) Backpacks, luggage, barrel bags, beach bags, duffel bags, gym bags, athletic bags, all-purpose sport bags, book bags, school bags, travel bags, travelling bags, cosmetic bags sold empty, garment bags for travel, fanny packs, wallets, credit card cases, change purses, purses, and soft luggage, all for use in conjunction with wrestling, wrestlers and wrestling sport entertainment only; Tote bags all for use in conjunction with wrestling, wrestlers and wrestling sport entertainment only.

### **Class 21**

(11) Beverage ware, namely, cups, drinking glasses, mugs, portable beverage coolers, bottle openers, plastic coasters, and thermal insulated containers for food and beverages, all for use in conjunction with wrestling, wrestlers and wrestling sport entertainment only; lunch boxes, commemorative plates, decorative plates, cookie jars, dinnerware, namely, plates, cups, saucers, bowls, snack trays, sports bottles sold empty, and non-metal piggy banks all for use in conjunction with wrestling, wrestlers and wrestling sport entertainment only; china figurines, porcelain figurines, china statuettes, porcelain statuettes, holiday ornaments of ceramic (not tree ornaments), and holiday ornaments of porcelain (not tree ornaments) all for use in conjunction with wrestling, wrestlers and wrestling sport entertainment only; toothbrushes for use in conjunction with

wrestling, wrestlers and wrestling sport entertainment only; Tin money banks for use in conjunction with wrestling, wrestlers and wrestling sport entertainment only.

### **Class 25**

(12) Clothing, namely, pajamas, robes, lingerie, nightgowns, bras, tank tops, fleece tops, hooded tops, halter tops, warm-up tops, sport shirts, dress shirts, polo shirts, undershirts, sweatshirts, sweaters, pullovers, blouses, yoga/exercise wear, lounge wear, raincoats, overcoats, topcoats, coats, trousers, jeans, jogging suits, exercise pants, exercise suits, sweatpants, boxer shorts, socks, shirts, jackets, pants, shorts, underwear, men's briefs, boxer shorts, socks, clothing ties, neck ties, and leather thongs, all for use in conjunction with wrestling, wrestlers and wrestling sport entertainment only; footwear, namely, shoes, sneakers, slippers, and boots all for use in conjunction with wrestling, wrestlers and wrestling sport entertainment only; headwear, namely, bandannas all for use in conjunction with wrestling, wrestlers and wrestling sport entertainment only; Halloween and masquerade costumes for use in conjunction with wrestling, wrestlers and wrestling sport entertainment only; belts, leather belts, replica championship belts, replica title belts, mini replica championship belts, mini replica title belts, and belt buckles all for use in conjunction with wrestling, wrestlers and wrestling sport entertainment only.

(13) T-shirts, for use in conjunction with wrestling, wrestlers and wrestling sport entertainment only.

(14) Gloves for use in conjunction with wrestling, wrestlers and wrestling sport entertainment only.

(15) Hats, caps, and wrist bands, all for use in conjunction with wrestling, wrestlers and wrestling sport entertainment only.

### **Class 28**

(16) Costume masks for use in conjunction with wrestling, wrestlers and wrestling sport entertainment only; Costume masks for use in conjunction with wrestling, wrestlers and wrestling sport entertainment only; Toy belts, toy championship belts, toy wrestling rings, dolls, toy action figure accessories, cases for action figures, bendable toys, toy miniature dolls, bobble-head dolls, puppets, collectible toy figures, doll furniture, porcelain dolls, and fantasy character toys, all for use in conjunction with wrestling, wrestlers and wrestling sport entertainment only; toy vehicles, cases for toy vehicles, skateboards all for use in conjunction with wrestling, wrestlers and wrestling sport entertainment only; board games, jigsaw puzzles, card games, and playing cards, all for use in conjunction with wrestling, wrestlers and wrestling sport entertainment only; kites, and aerodynamic discs for use in playing catching games, both for use in conjunction with wrestling, wrestlers and wrestling sport entertainment only; toy spinning tops, windup toys, and return toy tops, all for use in conjunction with wrestling, wrestlers and wrestling sport entertainment only; standalone video output game machines featuring wrestling, arcade game machines related to wrestling, pinball games and machines related to wrestling, hand-held units for playing electronic games, and tabletop action skill games related to wrestling, all for use in conjunction with wrestling, wrestlers and wrestling sport entertainment only; stuffed toy animals, and bean bag bears both for use in conjunction with wrestling, wrestlers and wrestling sport entertainment only; electronic toy guitars for use in conjunction with wrestling, wrestlers and wrestling sport entertainment only; water guns, inflatable pools, vinyl pool products, namely, pillow back lounge chair, one and two-man inflatable boats, personal watercraft, rafts, inner tubes, and foot pumps, all for use in conjunction with wrestling, wrestlers and wrestling sport entertainment only; Christmas tree decorations and Christmas stockings both for use in conjunction with wrestling, wrestlers and wrestling sport entertainment only; toy rockets, toy robots, and remote control robots, all for use in conjunction with wrestling, wrestlers and wrestling sport entertainment only; costume masks for use in conjunction with wrestling, wrestlers and wrestling sport entertainment only; party favors, namely, crackers and noisemakers both for use in conjunction with wrestling, wrestlers and

wrestling sport entertainment only; toy model kits, and plastic model kits, both for use in conjunction with wrestling, wrestlers and wrestling sport entertainment only; bowling balls and accessories, namely, bowling pins, bowling gloves, specially adapted bowling ball bags all for use in conjunction with wrestling, wrestlers and wrestling sport entertainment only; knee and elbow pads for athletic use for use in conjunction with wrestling, wrestlers and wrestling sport entertainment only; tin carrying cases especially adapted for play action figure accessories for use in conjunction with wrestling, wrestlers and wrestling sport entertainment only; toy foam hands for use in conjunction with wrestling, wrestlers and wrestling sport entertainment only; toy gum figure maker for use in conjunction with wrestling, wrestlers and wrestling sport entertainment only.

(17) Toy action figures and action figure clothing, both for use in conjunction with wrestling, wrestlers and wrestling sport entertainment only.

## **Services**

### **Class 38**

(1) Entertainment services, namely, television broadcasting services, pay-per-view television transmission services, and web television broadcasting services all for use in conjunction with wrestling, wrestlers and wrestling sport entertainment only; Entertainment in the form of video-on-demand television shows for use in conjunction with wrestling, wrestlers and wrestling sport entertainment only; provision of information via television broadcast in the field of video games for use in conjunction with wrestling, wrestlers and wrestling sports entertainment only; providing online chat rooms and electronic bulletin boards for transmission of messages among computer users in the field of video games for use in conjunction with wrestling, wrestlers and wrestling sport entertainment only.

(2) Providing online chat rooms and electronic bulletin boards for transmission of messages among computer users in the field of video games for use in conjunction with wrestling, wrestlers and wrestling sport entertainment only; providing an online community forum for transmission of messages among computer user members of a fan club for use in conjunction with wrestling, wrestlers and wrestling sport entertainment only.

### **Class 41**

(3) Entertainment provided over a global computer network, namely, streaming audio and video via the Internet featuring music, movies, television programs, web television programs, news, sports, and video games all for use in conjunction with wrestling, wrestlers and wrestling sport entertainment only; Entertainment in the form of television shows and web television programs provided over a global computer network all for use in conjunction with wrestling, wrestlers and wrestling sport entertainment only; entertainment services, namely, a television show about sports entertainment all for use in conjunction with wrestling, wrestlers and wrestling sport entertainment only; entertainment in the form of television programs for use in conjunction with wrestling, wrestlers and wrestling sport entertainment only; entertainment services, namely, a television show about professional wrestling; entertainment services, namely wrestling-related on-going reality based television program; entertainment in the form of television shows for use in conjunction with wrestling, wrestlers and wrestling sport entertainment only; entertainment in the form of web television shows all for use in conjunction with wrestling, wrestlers and wrestling sport entertainment only; entertainment in the form of reality television shows for use in conjunction with wrestling, wrestlers and wrestling sport entertainment only; provision of entertainment and sporting news and information via the Internet in the field of video games all for use in conjunction with wrestling, wrestlers and wrestling sport entertainment only; providing video games and sports entertainment through a website in the field of wrestling, wrestlers and wrestling sport entertainment only; providing online computer games and information about computer games

through the operation of a website for use in conjunction with wrestling, wrestlers and wrestling sport entertainment only; entertainment services, namely, provision of wrestling sports entertainment rendered live and through broadcast media, namely, television, radio, and via the internet; entertainment services, namely, providing online video games for use in conjunction with wrestling, wrestlers and wrestling sport entertainment only; entertainment services, namely, online temporary use of non-downloadable video games for use in conjunction with wrestling, wrestlers and wrestling sport entertainment only.

(4) Entertainment services, namely, the production and exhibition of professional wrestling events rendered live and through broadcast media, namely, television, radio, and via the internet; providing wrestling news and information via a global computer network for use in conjunction with wrestling, wrestlers and wrestling sports entertainment; provision of entertainment and sporting news and information via the Internet and television broadcast in the field of wrestling sport entertainment; providing information in the field of sports entertainment, namely, professional wrestling, and sports entertainment via an online community portal for use in conjunction with wrestling, wrestlers and wrestling sports entertainment only; providing information in the field of sports entertainment, namely, providing entertainment news and information in the field of television entertainment, reality television entertainment, motion picture entertainment, web television entertainment, and wrestling sports entertainment via the Internet and portable and wireless communication devices, all for use in conjunction with wrestling, wrestlers and wrestling sport entertainment only; providing sports entertainment via a website for use in conjunction with wrestling, wrestlers and wrestling sport entertainment only; fan club services, namely, organizing and staging events with fan club members, encouraging participation of fan club members for use in conjunction with wrestling, wrestlers and wrestling sport entertainment only, promoting the interest and participation of fan club members; publication of online newsletters in the fields of sports entertainment for use in conjunction with wrestling, wrestlers and wrestling sport entertainment only; publication of online journals via weblogs, in the fields of sports entertainment, for use in conjunction with wrestling, wrestlers and wrestling sport entertainment only.

#### **Class 45**

(5) Provision of online social networking services in the field of sports and entertainment for use in conjunction with wrestling, wrestlers and wrestling sport entertainment only.

**Application Number** 1,903,621  
**Language of Application** English

**Filing Date** 2018-06-11

## APPLICANT AND AGENT DETAILS

### Applicant

SERVIZI CONSORTILI COSTA SMERALDA S.  
p.A.  
CASA 1/A, IL GINEPRO  
PORTO CERVO, 07021 ARZACHENA,  
SASSARI  
ITALY

### Agent

SMART & BIGGAR LP  
SUITE 900, 55 METCALFE STREET, P.O.  
BOX 2999, STATION D, OTTAWA, ONTARIO,  
K1P5Y6

## TRADEMARK DETAILS

### Trademark Type

Design

### Visual Representation



# COSTA SMERALDA

### Goods

#### Class 03

(1) eau de Cologne; lavender water; toilet water; scented water; nail art stickers; adhesives for affixing false hair; adhesives for affixing false eyelashes; scouring solutions; starch glaze for laundry purposes; fabric softeners for laundry use; canned pressurized air for cleaning and dusting purposes; astringents for cosmetic purposes; lipstick cases; hair conditioners; bases for flower perfumes; joss sticks; cotton sticks for cosmetic purposes; whitening; laundry blueing; Javelle water; polishing paper; emery paper; sandpaper; abrasive paper; volcanic ash for cleaning; non-slipping wax for floors; shoemakers' wax; depilatory wax; mustache wax; polishing wax; floor wax; wax for

parquet floors; tailors' wax; shoe wax; polish for furniture and flooring; false eyelashes; make-up powder; mouthwashes, not for medical purposes; hair dyes; corundum [abrasive]; cosmetics; cosmetics for animals; cosmetics for children; cosmetic preparations for eyelashes; eyebrow cosmetics; cosmetic creams; shoe cream; creams for leather; polishing creams; skin whitening creams; bleaching preparations [decolorants] for cosmetic purposes; dentifrices; deodorants for pets; deodorants for animals; vaginal washes for personal sanitary or deodorant purposes; air fragrance reed diffusers; badian essence; mint essence [essential oil]; oil of turpentine for degreasing; bergamot oil; drying agents for dishwashing machines; petroleum jelly for cosmetic purposes; dental bleaching gels; geraniol; cleaning chalk; incense; ionone [perfumery]; hair spray; almond milk for cosmetic purposes; cleansing milk for toilet purposes; scented wood; non-slipping liquids for floors; windshield cleaning liquids; soda lye; after-shave lotions; hair lotions; lotions for cosmetic purposes; lip glosses; shoe polish; mascara; beauty masks; eyebrow pencils; cosmetic pencils; mint for perfumery; decorative transfers for cosmetic purposes; musk [perfumery]; cosmetic kits; neutralizers for permanent waving; essential oils of cedarwood; essential oils of lemon; essential oils of citron; gaultheria oil; jasmine oil; lavender oil; almond oil; rose oil; oils for perfumes and scents; oils for cosmetic purposes; cotton wool for cosmetic purposes; pastes for razor strops; cobblers' wax; hydrogen peroxide for cosmetic purposes; polishing stones; pumice stone; shaving stones [astringents]; pomades for cosmetic purposes; potpourris [fragrances]; sun-tanning preparations [cosmetics]; collagen preparations for cosmetic purposes; douching preparations for personal sanitary or deodorant purposes [toiletries]; descaling preparations for household purposes; laundry glaze; preparations for cleaning dentures; hair straightening preparations; hair waving preparations; denture polishes; sunscreen preparations; preparations for unblocking drain pipes; cosmetic preparations for slimming purposes; cosmetic preparations for skin care; depilatory preparations; antiperspirants [toiletries]; preparations to make the leaves of plants shiny; laundry bleach; dry-cleaning preparations; make-up preparations; preservatives for leather [polishes]; nail care preparations; shaving preparations; laundry soaking preparations; sachets for perfuming linen; wallpaper cleaning preparations; rust removing preparations; leather bleaching preparations; make-up removing preparations; paint stripping preparations; lacquer-removing preparations; varnish-removing preparations; perfumes; air fragrancing preparations; lipsticks; polishing rouge; safrol; laundry starch; bath salts, not for medical purposes; bleaching salts; tissues impregnated with make-up removing preparations; almond soap; shaving soap; cakes of toilet soap; soap for foot perspiration; antiperspirant soap; deodorant soap; soap for brightening textile; shampoos; shampoos for pets [non-medicated grooming preparations]; shampoos for animals [non-medicated grooming preparations]; dry shampoos; nail polish; emery; bleaching soda; nail varnish removers; breath freshening sprays; breath freshening strips; teeth whitening strips; cloths impregnated with a detergent for cleaning; floor wax removers [scouring preparations]; talcum powder, for toilet use; abrasive cloth; emery cloth; glass cloth [abrasive cloth]; terpenes [essential oils]; beard dyes; tissues impregnated with cosmetic lotions; turpentine for degreasing; tripoli stone for polishing; make-up; false nails

### **Class 09**

(2) Abacuses; bullet-proof clothing; particle accelerators; accelerometers; acoustic couplers; accumulators, electric; accumulators, electric, for vehicles; adding machines; aerometers; electronic agendas; needles for surveying compasses; stills for laboratory experiments; alcoholmeters; alidades; altimeters; loudspeakers; ammeters; retorts' stands; smart rings; anemometers; anticathodes; apertometers [optics]; chromatography apparatus for laboratory use; cameras [photography]; coin-operated musical automata [juke boxes]; appliances for measuring the thickness of leather; apparatus for measuring the thickness of skins; radios; vehicle radios; breathing apparatus for underwater swimming; demagnetizing apparatus for magnetic tapes; selfie

sticks [hand-held monopods]; containers for contact lenses; eyeglass cases; containers for microscope slides; actinometers; fire engines; automatic indicators of low pressure in vehicle tires; fire alarms; rods for water diviners; fire boats; barometers; joysticks for use with computers, other than for video games; weighbridges; fire beaters; batteries for electronic cigarettes; betatrons; scales with body mass analysers; bathroom scales; baby scales; binoculars; biochips; electromagnetic coils; coils, electric; snorkels; marking buoys; life buoys; signalling buoys; bags adapted for laptops; encoded identification bracelets, magnetic; tone arms for record players; directional compasses; marine compasses; electric wire harnesses for automobiles; decorative magnets; pocket calculators; calipers; slide calipers; screw-tapping gauges; calorimeters; shoes for protection against accidents, irradiation and fire; juke boxes for computers; decompression chambers; signal bells; electric door bells; telescopic sights for firearms; telescopic sights for Page 3 of 15 artillery; Petri dishes; life-saving capsules for natural disasters; toner cartridges, unfilled, for printers and photocopiers; video game cartridges; protective helmets for sports; riding helmets; virtual reality headsets; cabinets for loudspeakers; battery boxes; eyeglass chains; surveying chains; cathodes; coaxial cables; starter cables for motors; cables, electric; fiber optic cables; galvanic cells; photovoltaic cells; laboratory centrifuges; radio pagers; USB flash drives; cyclotrons; cinematographic film, exposed; cinematographic cameras; cell phone straps; life belts; integrated circuits; printed circuits; egg timers [sandglasses]; electronic collars to train animals; road signs, luminous or mechanical; comparators; computer hardware; laptop computers; thin client computers; optical condensers; electricity conduits; acoustic conduits; traffic cones; connections for electric lines; thread counters; pedometers; converters, electric; fire blankets; covers for smartphones; covers for electric outlets; eyeglass cords; digital photo frames; covers for personal digital assistants [PDAs]; covers for tablet computers; measuring spoons; headphones; sleeves for laptops; cases for smartphones; densimeters; densitometers; slide projectors; dynamometers; light-emitting diodes [LED]; baby monitors; electric and electronic effects units for musical instruments; video baby monitors; hemline markers; ticket dispensers; dictating machines; hand-held electronic dictionaries; dosage dispensers; computers; epidiascopes; ergometers; exposure meters [light meters]; fire extinguishers; electronic tags for goods; downloadable music files; plumb lines; identification threads for electric wires; copper wire, insulated; wires, electric; fuse wire; magnetic wires; telephone wires; telegraph wires; filters for respiratory masks; filters for ultraviolet rays, for photography; signalling whistles; dog whistles; sports whistles; flash-bulbs [photography]; flowmeters; furnaces for laboratory use; photocopiers [photographic, electrostatic, thermic]; photometers; frequency meters; galvanometers; gasometers [measuring instruments]; reflective safety vests; knee-pads for workers; record players; bullet-proof waistcoats; life jackets; downloadable graphics for mobile phones; grids for batteries; identification sheaths for electric wires; sheaths for electric cables; asbestos gloves for protection against accidents; gloves for protection against X-rays for industrial purposes; gloves for protection against accidents; gloves for divers; hydrometers; hygrometers; sprinkler systems for fire protection; signals, luminous or mechanical; incubators for bacteria culture; water level indicators; gasoline gauges; vacuum gauges; asbestos clothing for protection against fire; clothing for protection against fire; clothing for protection against irradiation and fire; clothing especially made for laboratories; digital signs; signs, luminous; mechanical signs; electric installations for the remote control of industrial operations; circuit closers; circuit breakers; hands-free kits for telephones; darkroom lamps [photography]; fire hose nozzles; signal lanterns; rescue laser signalling flares; lactodensimeters; electronic interactive whiteboards; contact lenses; correcting lenses [optics]; magnifying glasses [optics]; optical lenses; spectacle lenses; selfie lenses; cassette players; bar code readers; compact disc players; disk drives for computers; DVD players; optical character readers; electronic book readers; spirit levels; surveyors' levels; voting machines; money counting and sorting machines; punched card machines for offices; wind socks for indicating wind direction; fire hose; resuscitation



mannequins [teaching apparatus]; crash test dummies; junction sleeves for electric cables; pressure gauges; divers' masks; solderers' helmets; electronic pens [visual display units]; coin-operated mechanisms for television sets; megaphones; dressmakers' measures; metronomes; microphones; micrometers; microprocessors; microscopes; microtomes; time switches, automatic; viewfinders, photographic; ring sizers; finger sizers; satellite finder meters; audio mixers; furniture especially made for laboratories; modems; wearable video display monitors; eyeglass frames; videotapes; notebook computers; lenses for astrophotography; pince-nez; anti-glare glasses; sunglasses; goggles for sports; smartglasses; eyeglasses; 3D spectacles; ohmmeters; holograms; wavemeters; smartwatches; time clocks [time recording devices]; oscillographs; octants; ozonisers [ozonators]; levelling staffs [surveying instruments]; meteorological balloons; personal digital assistants [PDAs]; solar panels for the production of electricity; mouth guards for sports; lightning rods; lens hoods; spark-guards; head guards for sports; asbestos screens for firemen; parking meters; protective films adapted for computer screens; protective films adapted for smartphones; X-ray films, exposed; films, exposed; periscopes; acid hydrometers; acidimeters for batteries; lactometers; letter scales; salinometers; wafers for integrated circuits; galvanic batteries; solar batteries; plumb bobs; sounding leads; pipettes; pyrometers; plates for batteries; planimeters; wrist rests for use with computers; polarimeters; fire pumps; electronic key fobs being remote control apparatus; speaking tubes; computer operating programs, recorded; test tubes; push buttons for bells; light-emitting electronic pointers; needles for record players; square rulers for measuring; switchboards; current rectifiers; electrified fences; tape recorders; kilometer recorders for vehicles; cash registers; voltage surge protectors; speed regulators for record players; voltage regulators for vehicles; light dimmers [regulators], electric; stage lighting regulators; slide-rules; circular slide rules; relays, electric; rheostats; resistances, electric; respirators for filtering air; nets for protection against accidents; screens for photoengraving; chargers for electronic cigarettes; walkie-talkies; audio- and video-receivers; telephone receivers; refractometers; personal stereos; smoke detectors; counterfeit coin detectors; metal detectors for industrial or military purposes; laboratory robots; security surveillance robots; humanoid robots with artificial intelligence; electrified rails for mounting spot lights; saccharometers; sounding lines; satellites for scientific purposes; diving suits; fire escapes; marine depth finders; junction boxes [electricity]; printed circuit boards; memory cards for video game Page 4 of 15 machines; projection screens; fluorescent screens; workmen's protective face-shields; answering machines; semi-conductors; sirens; electronic access control systems for interlocking doors; smartphones; computer game software; computer screen saver software, recorded or downloadable; sulfimeters; sonars; electronic sheet music, downloadable; egg-candlers; spectrograph apparatus; spectrosopes; peepholes [magnifying lenses] for doors; automated teller machines [ATM]; carpenters' rules; T-squares for measuring; printers for use with computers; charging stations for electric vehicles; digital weather stations; radiotelephony sets; radiotelegraphy sets; stereoscopes; retorts; nose clips for divers and swimmers; stroboscopes; meteorological instruments; surveying instruments; subwoofers; downloadable ring tones for mobile phones; holders for electric coils; tablet computers; tachometers; ear plugs for divers; mouse pads; pressure indicator plugs for valves; taximeters; computer keyboards; plane tables [surveying instruments]; frames for photographic transparencies; teleprompters; rearview cameras for vehicles; facsimile machines; cellular phones; cordless telephones; telescopes; teleprinters; theodolites; interactive touch screen terminals; thermal imaging cameras; thermo-hygrometers; thermostats; thermostats for vehicles; masts for wireless aerials; totalizators; wearable activity trackers; electronic pocket translators; transistors [electronic]; step-up transformers; telephone transmitters; transponders; tripods for cameras; vehicle breakdown warning triangles; triodes; horns for loudspeakers; discharge tubes, electric, other than for lighting; capillary tubes; Pitot tubes; neon signs; protective suits for aviators; magnetic tape units for computers; urinometers; amplifying tubes; solenoid valves [electromagnetic switches]; thermionic tubes; variometers;

battery jars; laboratory trays; verniers; optical glass; camcorders; video cassettes; video screens; electronic notice boards; video telephones; viscosimeters; visors for helmets; micrometer screws for optical instruments; voltmeters; life-saving rafts; lighting ballasts

## Class 12

(3) Cigar lighters for automobiles; aeroplanes; amphibious airplanes; aircraft; masts for boats; transmission shafts for land vehicles; sun-blinds adapted for automobiles; anti-theft alarms for vehicles; ambulances; suspension shock absorbers for vehicles; shock absorbers for automobiles; brake segments for vehicles; anti theft devices for vehicles; head-rests for vehicle seats; trailer hitches for vehicles; railway couplings; motor buses; motor homes; motor coaches; motor racing cars; golf carts [vehicles]; robotic cars; sports cars; cars; panniers adapted for bicycles; vehicle joysticks; boats; tipping bodies for trucks; concrete mixing vehicles; bicycles; electric bicycles; flanges for railway wheel tires; bags adapted for pushchairs; saddlebags adapted for bicycles; panniers adapted for motorcycles; sculls; cars for cable transport installations; gear boxes for land vehicles; inner tubes for pneumatic tires; inner tubes for bicycle tires; vans [vehicles]; rubbish trucks; trucks; bicycle bells; canoes; hoods for vehicles; automobile hoods; stroller hoods; caravans; two-wheeled trolleys; roll cage trolleys; hose carts; fishing trolleys; forklift trucks; tilt trucks; shopping trolleys; handling carts; bogies for railway cars; tow trucks; wheelbarrows; wheelchairs; bodies for vehicles; automobile bodies; strollers; rolling stock for funicular railways; anti-skid chains; bicycle chains; driving chains for land vehicles; transmission chains for land vehicles; automobile chains; motorcycle chains; bicycle kickstands; motorcycle kickstands; brake shoes for vehicles; rims for vehicle wheels; tires for vehicle wheels; rims for bicycle wheels; baskets adapted for bicycles; barges; spikes for tires; mopeds; security harness for vehicle seats; safety belts for vehicle seats; hydraulic circuits for vehicles; stroller covers; casings for pneumatic tires [tyres]; spare wheel covers; saddle covers for motorcycles; sleeping berths for vehicles; hoods for vehicle engines; lug nuts for vehicle wheels; reduction gears for land vehicles; hub caps; brake discs for vehicles; steering gears for ships; disengaging gear for boats; dredgers [boats]; civilian drones; camera drones; military drones; saddle covers for bicycles; seat covers for vehicles; covers for vehicle steering wheels; bicycle brakes; brakes for vehicles; funnels for locomotives; funnels for ships; funiculars; delivery tricycles; bands for wheel hubs; solid tires for vehicle wheels; davits for boats; brake linings for vehicles; upholstery for vehicles; hydroplanes; seaplanes; gears for bicycles; sprinkling trucks; locomotives; driving motors for land vehicles; bicycle cranks; bicycle handlebars; motorcycle handlebars; rolling stock for railways; transmissions for land vehicles; shock absorbing springs for vehicles; vehicle suspension springs; hot air balloons; push scooters [vehicles]; motorcycles; jet engines for land vehicles; motor scooters; mobility scooters; bicycle motors; motorcycle engines; engines for land vehicles; tyre mousse inserts; hubs for vehicle wheels; hubs for bicycle wheels; ships; portholes; omnibuses; paddles for canoes; airships; fenders for ships; windscreens; parachutes; bicycle mudguards; mudguards; vehicle bumpers; bumpers for automobiles; brake pads for automobiles; bicycle pedals; spars for ships; inclined ways for boats; balance weights for vehicle wheels; pneumatic tires; automobile tires; bicycle tyres; pumps for bicycle tires; pontoons; luggage carriers for vehicles; rowlocks; ski carriers for cars; doors for vehicles; ashtrays for automobiles; vehicle running boards; screw-propellers; screw-propellers for boats; boat hooks; spokes for bicycle wheels; axle journals; oars; buffers for railway rolling stock; luggage nets for vehicles; dress guards for bicycles; rearview mirrors; bicycle trailers; trailers for transporting bicycles; adhesive rubber patches for repairing inner tubes; mine cart wheels; bicycle wheels; fitted footmuffs for prams; fitted footmuffs for pushchairs; tilting-carts; ship hulls; repair outfits for inner tubes; ski lifts; safety seats for children, for vehicles; vehicle seats; ejector seats for aircraft; chairlifts; reversing alarms for vehicles; bicycle saddles; motorcycle saddles; kick sledges; bellows for articulated buses; side view mirrors for

vehicles; spoilers for vehicles; treads for retreading tires; engine mounts for land vehicles; caps for vehicle fuel tanks; vehicle chassis; automobile chassis; bicycle frames; motorcycle frames; spoke clips for wheels; windshield wipers; headlight wipers; tractors; undercarriages for vehicles; tricycles; tubeless tires for bicycles; mine cars; railway carriages; refrigerated railway wagons; sleeping cars; dining cars; valves for vehicle tires; air cushion vehicles; autonomous underwater vehicles for seabed inspections; armored vehicles; snowmobiles; space vehicles; windows for vehicles; tramcars; driverless cars [autonomous cars]; steering wheels for vehicles; yachts; fitted stroller mosquito nets

#### **Class 14**

(4) Agates; jet, unwrought or semi-wrought; amulets [jewelry]; split rings of precious metal for keys; spun silver [silver wire]; silver, unwrought or beaten; shoe jewelry; hat jewelry; bracelets [jewelry]; bracelets made of embroidered textile [jewellery]; watch bands; busts of precious metal; cabochons; watch cases [parts of watches]; clock cases; watch chains; clasps for jewelry; jewellery charms; charms for key rings; necklaces [jewelry]; crucifixes as jewelry; chronometers; stopwatches; chronoscopes; diamonds; tie clips; figurines [statuettes] of precious metal; gold thread [jewelry]; silver thread [jewelry]; jewelry findings; cuff links; copper tokens; jewelry; ivory jewelry; cloisonné jewelry; jewelry of yellow amber; badges of precious metal; iridium; clock hands; watch hands; alloys of precious metal; ingots of precious metals; movements for clocks and watches; medals; lockets [jewelry]; precious metals, unwrought or semi-wrought; misbaha [prayer beads]; watch springs; coins; works of art of precious metal; olivine [gems]; earrings; ornaments of jet; gold, unwrought or beaten; clocks; atomic clocks; wristwatches; watches; control clocks [master clocks]; clocks and watches, electric; osmium; palladium; pearls made of ambroid [pressed amber]; pearls [jewelry]; beads for making jewelry; semi-precious stones; precious stones; platinum [metal]; key rings [split rings with trinket or decorative fob]; sundials; rhodium; rosaries; clockworks; ruthenium; presentation boxes for jewelry; boxes of precious metal; jewelry boxes; presentation boxes for watches; tie pins; ornamental pins; spinel [precious stones]; statues of precious metal; paste jewelry [costume jewelry]; alarm clocks; watch glasses

#### **Class 16**

(5) Etchings; aquarelles; adhesives [glues] for stationery or household purposes; franking machines for office use; almanacs; cigar bands; hand-rests for painters; modelling clay; bookbinding material; towels of paper; stencil cases; cases for stamps [seals]; atlases; stickers [stationery]; banknotes; ink sticks; chart pointers, non-electronic; bibs of paper; adhesive bands for stationery or household purposes; table linen of paper; musical greeting cards; greeting cards; drawing pads; spools for inking ribbons; retractable reels for name badge holders [office requisites]; architects' models; wristbands for the retention of writing instruments; etching needles; tracing needles for drawing purposes; envelopes [stationery]; inkwells; tracing patterns; calendars; writing board erasers; song books; hat boxes of cardboard; printing type; paper; carbon paper; copying paper [stationery]; paper for medical examination tables; wrapping paper; writing paper; silver paper; tracing paper; wood pulp paper; rice paper; filter paper; toilet paper; luminous paper; sewing patterns; waxed paper; paper for recording machines; drawer liners of paper, perfumed or not; electrocardiograph paper; parchment paper; papers for painting and calligraphy; paper for radiograms; papier mâché; geographical maps; desk mats; folders for papers; signboards of paper or cardboard; placards of paper or cardboard; posters; postcards; cardboard; perforated cards for Jacquard looms; catalogues; tags for index cards; painters' easels; animation cels; tablemats of paper; sealing wax; letter trays; hectographs; mimeograph apparatus and machines; electrotypes; printing blocks; pen clips; clips for name badge holders [office requisites]; starch paste [adhesive] for stationery or household purposes; glue for stationery or household purposes; compasses for drawing; covers of paper for flower pots; chromolithographs [chromos]; adhesive tape dispensers

[office requisites]; finger-stalls [office requisites]; elastic bands for offices; labels of paper or cardboard; marking pens [stationery]; handkerchiefs of paper; paperweights; staples for offices; page holders; bunting of paper; figurines [statuettes] of papier mâché; cords for bookbinding; paper coffee filters; paper bows, other than haberdashery or hair decorations; plastic bubble packs for wrapping or packaging; absorbent sheets of paper or plastic for foodstuff packaging; paper sheets [stationery]; sheets of reclaimed cellulose for wrapping; viscose sheets for wrapping; humidity control sheets of paper or plastic for foodstuff packaging; photographs [printed]; photo-engravings; postage stamps; comic books; flags of paper; paper clasps; marking chalk; tailors' chalk; writing chalk; spray chalk; chalk for lithography; newspapers; rubber erasers; paper-clips; bottle wrappers of paper or cardboard; stuffing of paper or cardboard; pictures; graphic prints; ink; Indian inks; bottle envelopes of paper or cardboard; engraving plates; address plates for addressing machines; blackboards; writing slates; steel letters; booklets; books; printers' reglets; correcting fluids [office requisites]; lithographs; typewriters, electric or non-electric; envelope sealing machines for offices; stapling presses [office requisites]; addressing machines; pencil sharpening machines, electric or non-electric; manuals [handbooks]; terrestrial globes; stencils [stationery]; stencil plates; packaging material made of starches; packing [cushioning, stuffing] materials of paper or cardboard; sealing compounds for stationery purposes; plastics for modelling; pencils; charcoal pencils; slate pencils; stencils; pencil leads; handwriting specimens for copying; adhesive tapes for stationery or household purposes; self-adhesive tapes for stationery or household purposes; correcting tapes [office requisites]; paper ribbons, other than haberdashery or hair decorations; inking ribbons for computer printers; inking ribbons; typewriter ribbons; pen wipers; engravings; lithographic works of art; oleographs; pamphlets; printed timetables; announcement cards [stationery]; modelling paste; pastels [crayons]; plastic film for wrapping; plastic cling film, extensible, for palletization; pens [office requisites]; paintbrushes; writing brushes; painters' brushes; nibs of gold; steel pens; office perforators; periodicals; graining combs; bibs, sleeved, of paper; blueprints; artists' watercolor saucers; cream containers of paper; paper creasers [office requisites]; lithographic stones; ink stones [ink reservoirs]; money clips; paintings [pictures], framed or unframed; polymer modelling clay; advertisement boards of paper or cardboard; holders for cheque books; chalk holders; pencil lead holders; passport holders; penholders; pen cases; credit card imprinters, non-electric; prospectuses; drawing pins; writing or drawing books; loose-leaf binders; bookends; ledgers [books]; indexes; drawing rulers; square rulers for drawing; portraits; magazines [periodicals]; house painters' rollers; table runners of paper; bags [envelopes, pouches] of paper or plastics, for packaging; conical paper bags; paper bags for use in the sterilization of medical instruments; plastic bags for pet waste disposal; bags for microwave cooking; garbage bags of paper or of plastics; face towels of paper; boxes of paper or cardboard; paint boxes [articles for use in school]; index cards [stationery]; bookmarkers; inkstands; place mats of paper; biological samples for use in microscopy [teaching materials]; histological sections for teaching purposes; balls for ball-point pens; stands for pens and pencils; mats for beer glasses; coasters of paper; printed sheet music; T-squares for drawing; squares for drawing; molds for modelling clays [artists' materials]; fountain pens; fabrics for bookbinding; paper tapes and cards for the recordal of computer programmes; banners of paper; drawing instruments; writing instruments; French curves; photograph stands; stamp stands; note books; paper knives [letter openers]; paper cutters [office requisites]; printed coupons; blotters; stamp pads; inking pads; typewriter keys; drawing boards; clipboards; palettes for painters; tracing cloth; bookbinding cloth; inking sheets for document reproducing machines; inking sheets for duplicators; gummed cloth for stationery purposes; canvas for painting; pencil sharpeners, electric or non-electric; trading cards, other than for games; address stamps; sealing stamps; drawing pens; tablecloths of paper; dental tray covers of paper; table napkins of paper; tissues of paper for removing make-up; transparencies [stationery]; paper shredders for office use; cardboard tubes; paint trays; trays for

sorting and counting money; flyers; washi

### **Class 18**

(6) Clothing for pets; umbrella rings; saddle trees; saddlery; key cases; fastenings for saddles; harness for animals; mountaineering sticks; hiking sticks; walking sticks; umbrella sticks; vanity cases, not fitted; trunks [luggage]; travelling trunks; bags [envelopes, pouches] of leather, for packaging; saddlebags; beach bags; bags for sports; shopping bags; wheeled shopping bags; chain mesh purses; purses; handbags; tool bags, empty; reins for guiding children; bridoons; straps for soldiers' equipment; kid; briefcases; conference folders; school satchels; leatherboard; cases of leather or leatherboard; halters; girths of leather; shoulder belts [straps] of leather; collars for animals; horse collars; horse blankets; leather laces; leather straps; straps of leather [saddlery]; harness straps; straps for skates; compression cubes adapted for luggage; leather, unworked or semi-worked; labels of leather; horseshoes; leather thread; umbrella covers; whips; knee-pads for horses; casings, of leather, for springs; covers for horse saddles; pads for horse saddles; trimmings of leather for furniture; leather leashes; sling bags for carrying infants; imitation leather; walking stick handles; grips for holding shopping bags; umbrella handles; suitcase handles; slings for carrying infants; pouch baby carriers; cat o' nine tails; chin straps, of leather; bits for animals [harness]; parasols; umbrellas; fur; goldbeaters' skin; animal skins; cattle skins; curried skins; chamois leather, other than for cleaning purposes; parts of rubber for stirrups; business card cases; credit card cases [wallets]; card cases [notecases]; pocket wallets; music cases; randsels [Japanese school satchels]; net bags for shopping; furniture coverings of leather; haversacks; nose bags [feed bags]; bags for campers; travelling bags; bags for climbers; boxes of leather or leatherboard; boxes of vulcanized fiber; hat boxes of leather; walking stick seats; riding saddles; saddlecloths for horses; stirrups; stirrup leathers; umbrella or parasol ribs; luggage tags; frames for umbrellas or parasols; handbag frames; attaché cases; suitcases; suitcases with wheels; garment bags for travel; motorized suitcases; rucksacks

### **Class 25**

(7) cyclists' clothing; clothing for gymnastics; dresses; suits; jumper dresses; bath robes; bandanas [neckerchiefs]; caps [headwear]; berets; underwear; sweat-absorbent underwear; corsets [underclothing]; galoshes; skull caps; leotards; boots for sports; sweat-absorbent stockings; socks; sweat-absorbent socks; breeches for wear; bathing trunks; albs; shirts; short-sleeve shirts; sports singlets; hats; top hats; coats; chasubles; belts [clothing]; money belts [clothing]; tights; camisoles; layettes [clothing]; corselets; bathing suits; masquerade costumes; beach clothes; neckties; ascots; bathing caps; shower caps; panties; headbands [clothing]; pocket squares; fittings of metal for footwear; scarfs; gabardines [clothing]; boot uppers; gaiters; jackets [clothing]; garters; fishing vests; stuff jackets [clothing]; skirts; overalls; aprons [clothing]; girdles; gloves [clothing]; mittens; ski gloves; welts for footwear; jerseys [clothing]; kimonos; liveries; hosiery; sports jerseys; sweaters; maniples; hairdressing capes; pelerines; mantillas; sleep masks; skorts; boxer shorts; slippers [underclothing]; babies' pants [underwear]; underpants; wet suits for water-skiing; vests; trousers; slippers; ear muffs [clothing]; parkas; pelisses; shirt yokes; pajamas; cuffs; ponchos; tips for footwear; stocking suspenders; sock suspenders; brassieres; heelpieces for stockings; sandals; bath sandals; saris; sarongs; neck scarfs [mufflers]; shoes; esparto shoes or sandals; bath slippers; gymnastic shoes; beach shoes; football boots; sports shoes; ski boots; shawls; sashes for wear; wimples; inner soles; overcoats; dress shields; petticoats; trouser straps; shirt fronts; half-boots; lace boots; boots; fur stoles; soles for footwear; studs for football boots; heels; heelpieces for footwear; pockets for clothing; tee-shirts; judo uniforms; karate uniforms; togas; ankle boots; turbans; valenki [felted boots]; veils [clothing]; dressing gowns; cap peaks; wooden shoes

### **Class 28**

(8) Christmas trees of synthetic material; masts for sailboards; swings; fish hooks; needles for pumps for inflating balls for games; tennis ball throwing apparatus; video game machines; kites; bows for archery; fencing weapons; fishing tackle; ski bindings; dolls; matryoshka dolls; Christmas tree stands; golf clubs; hockey sticks; twirling batons; stationary exercise bicycles; marbles for games; skittles; skittles [games]; starting blocks for sports; playing balls; bodyboards; cricket bags; golf bags, with or without wheels; water wings; gut for rackets; cups for dice; kaleidoscopes; dolls' rooms; bells for Christmas trees; rods for fishing; paper party hats; golf bag carts; playing cards; dolls' houses; rocking horses; chips for gambling; swimming belts; surfboard leashes; controllers for game consoles; Christmas crackers [party novelties]; strings for rackets; confetti; gut for fishing; dice; ornaments for Christmas trees, except illumination articles and confectionery; hang gliders; discuses for sports; flying discs [toys]; billiard markers; artificial fishing bait; decoys for hunting or fishing; chest expanders [exercisers]; horseshoe games; toy figures; sling shots [sports articles]; hunting game calls; darts; swimming pool air floats; floats for fishing; chalk for billiard cues; counters [discs] for games; toys for pets; rattles [playthings]; amusement machines, coin-operated; board games; building games; checkers [games]; dominoes; chess games; parlor games; portable games with liquid crystal displays; pachinkos; fairground ride apparatus; gyroscopes and flight stabilizers for model aircraft; snow globes; scratch cards for playing lottery games; baseball gloves; golf gloves; fencing gauntlets; batting gloves [accessories for games]; boxing gloves; bob-sleighs; climbers' harness; harness for sailboards; toy imitation cosmetics; joysticks for video games; fishing lines; dolls' beds; gaming machines for gambling; ball pitching machines; arcade video game machines; mah-jong; dumb-bells; bar-bells; puppets; carnival masks; theatrical masks; fencing masks; toy mobiles; scale model vehicles; toy models; reels for fishing; paintballs [ammunition for paintball guns] [sports apparatus]; creels [fishing traps]; rhythmic gymnastics ribbons; artificial snow for Christmas trees; teddy bears; baby gyms; poles for pole vaulting; billiard balls; play balloons; swimming jackets; paragliders; toy dough; roller skates; in-line roller skates; ice skates; protective films adapted for screens for portable games; stuffed toys; plush toys with attached comfort blanket; plush toys; party poppers [party novelties]; quoits; clay pigeons [targets]; roulette wheels; piñatas; flippers for swimming; toy air pistols; toy pistols; paintball guns [sports apparatus]; toy putty; pumps specially adapted for use with balls for games; dolls' feeding bottles; candle holders for Christmas trees; punching bags; billiard cue tips; jigsaw puzzles; snowshoes; rosin used by athletes; nets for sports; landing nets for anglers; butterfly nets; tennis nets; scent lures for hunting or fishing; sole coverings for skis; toy robots; kite reels; rollers for stationary exercise bicycles; bags especially designed for skis and surfboards; chessboards; bingo cards; camouflage screens [sports articles]; surf skis; waterskis; bite sensors [fishing tackle]; skateboards; men's athletic supporters [sports articles]; slot machines [gaming machines]; snowboards; edges of skis; billiard table cushions; billiard cues; skating boots with skates attached; bite indicators [fishing tackle]; paddleboards; sailboards; surfboards; swimming kick boards; billiard tables; coin operated billiard tables; checkerboards; foosball tables; tables for table tennis; clay pigeon traps; slides [playthings]; trampolines; spring boards [sports articles]; tricycles for infants [toys]; backgammon games; spinning tops [toys]; toy vehicles; remote-controlled toy vehicles; dolls' clothes; shuttlecocks

## Services

### Class 35

(1) rental of vending machines; updating and maintenance of data in computer databases; shop window dressing; administration of consumer loyalty programs; administration of frequent flyer programs; cost price analysis; administrative assistance in responding to calls for tenders; business management assistance; compilation of information into computer databases; business management consultancy; compilation of statistics; business management of hotels; business

management of sports people; business management for freelance service providers; business management of reimbursement programs for others; business management of performing artists; interim business management; web indexing for commercial or advertising purposes; layout services for advertising purposes; rental of advertising space; negotiation of business contracts for others; negotiation and conclusion of commercial transactions for third parties; rental of photocopying machines; office machines and equipment rental; rental of billboards [advertising boards]; rental of sales stands; organization of fashion shows for promotional purposes; web site traffic optimization; search engine optimization for sales promotion; business efficiency expert services; payroll preparation; economic forecasting; production of teleshopping programmes; publication of publicity texts; personnel recruitment; writing of résumés for others; marketing research; market studies; document reproduction; scriptwriting for advertising purposes; psychological testing for the selection of personnel; wholesale services for pharmaceutical, veterinary and sanitary preparations and medical supplies; arranging newspaper subscriptions for others; advertising agency services; import-export agency services; tax filing services; price comparison services; personnel management consultancy; advisory services for business management; business organization consultancy; business management and organization consultancy; typing; photocopying services; computerized file management; business project management services for construction projects; modelling for advertising or sales promotion; market intelligence services; business intermediary services relating to the matching of potential private investors with entrepreneurs needing funding; news clipping services; gift registry services; relocation services for businesses; telephone answering for unavailable subscribers; secretarial services; shorthand; telemarketing services; employment agency services; retail services for pharmaceutical, veterinary and sanitary preparations and medical supplies; online retail services for downloadable digital music; online retail services for downloadable and pre-recorded music and movies; online retail services for downloadable ring tones; retail services for works of art provided by art galleries; opinion polling; tax preparation; drawing up of statements of accounts; administrative processing of purchase orders; word processing; business appraisals; auctioneering; business auditing

(2) book-keeping; invoicing; public relations

### **Class 36**

(3) Rental of apartments; rental of farms; rental of offices for co-working; financial management; financial analysis; providing rebates at participating establishments of others through use of a membership card; securities brokerage; insurance consultancy; mutual funds; safe deposit services; issuance of travelers' checks; issuance of tokens of value; issuance of credit cards; investment of funds; surety services; financial management of reimbursement payments for others; insurance information; stocks and bonds brokerage; brokerage of carbon credits; capital investment; lease-purchase financing; rental of real estate; rental of offices [real estate]; insurance brokerage; online banking; exchanging money; instalment loans; lending against security; pawnbrokerage; arranging finance for construction projects; stock exchange quotations; rent collection; actuarial services; banking; credit bureau services; debt collection agency services; savings bank services; bail-bonding; charitable fund raising; debt advisory services; stock brokerage services; mortgage banking; fiscal valuation; trusteeship; financial customs brokerage services; insurance underwriting; fire insurance underwriting; accident insurance underwriting; health insurance underwriting; marine insurance underwriting; life insurance underwriting; financial evaluation of standing timber; real estate appraisal; stamp appraisal; jewelry appraisal; art appraisal; antique appraisal; numismatic appraisal; financial evaluation of wool; electronic funds transfer; processing of credit card payments; processing of debit card payments; financial appraisals in responding to calls for tenders; check verification

(4) real estate management; apartment house management; real estate brokerage; real estate agency services

### **Class 37**

(5) Tuning of musical instruments; rental of dishwashing machines; rental of dish drying machines; knife sharpening; asphaltting; riveting; pier breakwater building; harbour construction; building of fair stalls and shops; shipbuilding; underwater construction; factory construction; demolition of buildings; rat exterminating; mining extraction; upholstering; installation of doors and windows; pipeline construction and maintenance; installation and repair of air-conditioning apparatus; elevator installation and repair; warehouse construction and repair; fire alarm installation and repair; furnace installation and repair; freezing equipment installation and repair; heating equipment installation and repair; telephone installation and repair; office machines and equipment installation, maintenance and repair; installation, maintenance and repair of computer hardware; kitchen equipment installation; dry cleaning; washing of linen; diaper cleaning; vehicle washing; plumbing; painting, interior and exterior; plastering; vehicle greasing; vehicle polishing; furniture maintenance; swimming-pool maintenance; vehicle maintenance; airplane maintenance and repair; motor vehicle maintenance and repair; burner maintenance and repair; strong-room maintenance and repair; safe maintenance and repair; leather care, cleaning and repair; fur care, cleaning and repair; paper hanging; scaffolding; masonry; rental of bulldozers; rental of excavators; rental of cranes [construction equipment]; rental of construction equipment; rental of laundry washing machines; rental of road sweeping machines; rental of drainage pumps; painting or repair of signs; pumicing; laying of cable; bricklaying; cleaning of clothing; vehicle cleaning; cleaning of buildings [interior]; window cleaning; boiler cleaning and repair; furniture restoration; restoration of works of art; restoration of musical instruments; vehicle battery charging; retreading of tires; rebuilding engines that have been worn or partially destroyed; clothing repair; umbrella repair; parasol repair; clock and watch repair; pump repair; shoe repair; film projector repair and maintenance; chimney sweeping; re-tinning; sanding; roofing services; tire balancing; carpentry services; hydraulic fracturing services; artificial snow-making services; laundering; pest control services, other than for agriculture, aquaculture, horticulture and forestry; refilling of toner cartridges; vehicle breakdown repair services; building insulating; building sealing; quarrying services; vehicle service stations [refuelling and maintenance]; sterilization of medical instruments; pressing of clothing; linen ironing; building construction supervision; rustproofing; anti-rust treatment for vehicles; drilling of wells; drilling of deep oil or gas wells; vulcanization of tires [repair]

(6) burglar alarm installation and repair; cleaning of buildings [exterior surface]; street cleaning; road paving; repair of power lines; repair of security locks

### **Class 39**

(7) rental of electric wine cellars; motor coach rental; franking of mail; parcel delivery; flower delivery; delivery of goods by mail order; boat storage; delivery of newspapers; portorage; providing driving directions for travel purposes; physical storage of electronically stored data or documents; traffic information; launching of satellites for others; stevedoring; operating canal locks; shipbrokerage; freight brokerage [forwarding (Am.)]; aircraft rental; car rental; boat rental; rental of diving bells; horse rental; rental of storage containers; refrigerator rental; rental of warehouses; rental of aircraft engines; rental of vehicle roof racks; parking place rental; garage rental; rental of diving suits; rental of wheelchairs; rental of tractors; railway truck rental; vehicle rental; rental of motor racing cars; railway coach rental; arranging of cruises; arranging of transportation for travel tours; booking of seats for travel; travel reservation; underwater salvage; refloating of ships; cash replenishment of automated teller machines; towing; salvage of ships; unloading cargo; chauffeur services; bus transport; pleasure boat transport; car sharing services; gift wrapping; courier



services [messages or merchandise]; bottling services; car parking; vehicle breakdown towing services; ice breaking; salvaging; freight forwarding; taxi transport; streetcar transport; lighterage services; transporting furniture; armored-car transport; transport of travellers; transport and storage of trash; ambulance transport; barge transport; ferry-boat transport; guarded transport of valuables

#### **Class 41**

(8) animal training; rental of tennis courts; rental of motion pictures; providing casino facilities [gambling]; music composition services; conducting guided climbing tours; conducting fitness classes; timing of sports events; providing golf facilities; aikido instruction; gymnastic instruction; boarding school education; sign language interpretation; microfilming; production of radio and television programmes; videotape editing; rental of indoor aquaria; rental of lighting apparatus for theatrical sets or television studios; rental of radio and television sets; rental of skin diving equipment; rental of sports equipment, except vehicles; toy rental; rental of video cassette recorders; rental of artwork; rental of video cameras; rental of videotapes; organization of cosplay entertainment events; organization of balls; arranging of beauty contests; organization of lotteries; organization of fashion shows for entertainment purposes; vocational guidance [education or training advice]; party planning [entertainment]; booking of seats for shows; film production, other than advertising films; publication of books; electronic desktop publishing; presentation of circus performances; theatre productions; scriptwriting, other than for advertising purposes; writing of texts; videotaping; photographic reporting; vocational retraining; sado instruction [tea ceremony instruction]; screenplay writing; nursery schools; modelling for artists; lending library services; mobile library services; calligraphy services; sport camp services; health club services [health and fitness training]; songwriting; news reporters services; disc jockey services; discotheque services; physical education; photography; zoological garden services; language interpreter services; karaoke services; nightclub services [entertainment]; providing films, not downloadable, via video-on-demand services; providing television programs, not downloadable, via video-on-demand services; providing museum facilities [presentation, exhibitions]; orchestra services; amusement park services; providing amusement arcade services; recording studio services; movie studio services; translation; subtitling; tutoring

(9) on-line publication of electronic books and journals

#### **Class 43**

(10) Providing campground facilities; rental of drinking water dispensers; rental of meeting rooms; rental of chairs, tables, table linen, glassware; rental of tents; hotel reservations; boarding house bookings; food sculpting; hotel services; day-nursery [crèche] services; bar services; café services; cafeteria services; retirement home services; food and drink catering; canteen services; motel services; boarding house services; boarding for animals; restaurant services; self-service restaurant services; udon and soba restaurant services; washoku restaurant services; snack-bar services

#### **Class 44**

(11) Animal breeding; veterinary assistance; chiropractic; tree surgery; plastic surgery; flower arranging; wreath making; pharmacy advice; depilatory waxing; rehabilitation for substance abuse patients; vermin exterminating for agriculture, aquaculture, horticulture and forestry; weed killing; physical therapy; hair implantation; speech therapy; massage; medical equipment rental; farming equipment rental; horticulture; tree planting for carbon offsetting purposes; body piercing; preparation of prescriptions by pharmacists; aquaculture services; public bath services for hygiene purposes; health spa services; Turkish bath services; blood bank services; human tissue bank services; nursing home services; rest home services; convalescent home services; medical clinic services; palliative care; in vitro fertilization services; artificial insemination services; pest control

services for agriculture, aquaculture, horticulture and forestry; manicuring; dentistry services; orthodontic services; hospice services; midwife services; services of a psychologist; reforestation services; beauty salon services; hairdressing; sanatorium services; sauna services; telemedicine services; visagists' services; plant nursery services; opticians' services; hospital services; aerial and surface spreading of fertilizers and other agricultural chemicals; animal grooming; tattooing; pet grooming

(12) landscape design; gardening; lawn care; landscape gardening; nursing, medical

### **Class 45**

(13) Escorting in society [chaperoning]; personal body guarding; clothing rental; evening dress rental; legal administration of licences; opening of security locks; kimono dressing assistance; babysitting; horoscope casting; licensing of intellectual property; licensing of computer software [legal services]; licensing [legal services] in the framework of software publishing; conducting funeral ceremonies; astrology consultancy; intellectual property consultancy; legal advice in responding to requests for proposals [RFPs]; personal wardrobe styling consultancy; spiritual consultancy; security screening of baggage; crematorium services; copyright management; personal background investigations; inspection of factories for safety purposes; leasing of internet domain names; mediation; rental of safes; rental of fire extinguishers; rental of fire alarms; organization of religious meetings; planning and arranging of wedding ceremonies; personal letter writing; registration of domain names [legal services]; lost property return; genealogical research; legal research; missing person investigations; arbitration services; adoption agency services; night guard services; detective agency services; marriage agency services; cartomancy services; dating services; litigation services; legal watching services; dog walking services; legal document preparation services; embalming services; burial services; releasing doves for special occasions; tracking of stolen property; house sitting; funerary undertaking; alternative dispute resolution services; fire-fighting; monitoring intellectual property rights for legal advisory purposes; legal services in relation to the negotiation of contracts for others; on-line social networking services; pet sitting

(14) monitoring of burglar and security alarms

**Application Number** 1,906,636  
**Language of Application** English

**Filing Date** 2018-06-27

## APPLICANT AND AGENT DETAILS

### Applicant

A.H. Riise Spirits ApS  
A.P. Møllers Allé 9 C  
DK-2791 Dragør,  
DENMARK

### Agent

CLARK WILSON LLP  
900 - 885 WEST GEORGIA STREET,  
VANCOUVER, BRITISH COLUMBIA, V6C3H1

## TRADEMARK DETAILS

# A.H. RIISE

### Trademark Type

Standard Characters

### Goods

#### Class 33

Alcoholic beverages except beer, namely rum.

**Application Number** 1,910,970  
**Language of Application** English

**Filing Date** 2018-07-23

## APPLICANT AND AGENT DETAILS

### Applicant

Oxford Nanopore Technologies Limited  
Gosling Building  
Edmund Halley Road  
Oxford Science Park  
Oxford, OX4 4DQ  
UNITED KINGDOM

### Agent

BERESKIN & PARR LLP/S.E.N.C.R.L., S.R.L.  
SCOTIA PLAZA, 40 KING STREET WEST,  
40th FLOOR, TORONTO, ONTARIO, M5H3Y2

## TRADEMARK DETAILS

# MinIT

### Trademark Type

Standard Characters

### Goods

#### Class 09

(1) Electronic sensing apparatus, namely sensors used in electronic scientific equipment for detecting, manipulating and analysing biological, bacteriological, chemical and biochemical matter, DNA, RNA, proteins, polynucleic acids and small molecules; apparatus and instruments for biological, bacteriological, chemical, biochemical, DNA, RNA, protein, polynucleic acid and molecular analysis, optical and electrochemical analysis, medical diagnosis, measurement of ions, namely, automated instruments for detecting the presence, properties and identity of analytes, comprising cartridges, microarrays, silicon chip based arrays, ASICs (application specific integrated circuits), and networked computer hardware and software for performing and controlling the analysis, and for processing, displaying and storing the information obtained from the analysis for scientific and research purposes; portable apparatus and instruments for biological, bacteriological, chemical, biochemical, DNA, RNA, protein, polynucleic acid and molecular analysis, optical and electrochemical analysis, medical diagnosis, measurement of ions, namely, automated instruments for detecting the presence, properties and identity of analytes, comprising cartridges, microarrays, silicon chip based arrays, ASICs (application specific integrated circuits), and networked computer hardware and software for performing and controlling the analysis, and for processing, displaying and storing the information obtained from the analysis for scientific and research purposes; scientific apparatus and instruments for sequencing DNA, RNA, proteins and polynucleic acids; scientific apparatus and laboratory devices for the scientific analysis of polynucleic acid sequences; apparatus and instruments for the analysis of nucleic and polynucleic acids, namely, microarrays, and silicon chip based arrays for scientific and research purposes; apparatus and instruments for the analysis of proteins namely, microarrays, and silicon chip based arrays for scientific and research purposes; apparatus and instruments for the analysis of genetic information, genomic information and proteomic information, namely, automated instruments for detecting the presence, properties and identity of analytes, comprising cartridges, microarrays, silicon chip based arrays, ASICS (application specific integrated circuits), and networked computer hardware and software for performing and controlling the analysis, and for processing, displaying and storing the information obtained from the analysis; apparatus and instruments for use in

laboratory analysis namely, cartridges for use with concentrates and solutions in solid and liquid form samples for sequencing and synthesising chemical compounds, small molecules, genomes, DNA, RNA and other nucleic acids, oligosaccharides, proteins and peptides for scientific and research purposes; computer docking stations; diagnostic and testing apparatus, for scientific and research purposes, namely, laboratory test tubes, centrifuges for laboratory use, constant temperature incubators for laboratory use, vacuum distillation columns for laboratory use; monitoring apparatus and instruments namely monitors for the display of information obtained from scientific equipment; scientific apparatus and instruments for sequencing and synthesising chemical compounds, small molecules, genomes, DNA, RNA and other nucleic acids, oligosaccharides, proteins and peptides for scientific and research purposes; portable scientific apparatus, devices and instruments for identifying, measuring, analysing, sequencing and synthesising small molecules, genomes, DNA, RNA and other nucleic acids, oligosaccharides, proteins and peptides for use in the fields of genomics, medical sciences, environmental research, agriculture, general health and well-being, national security and military defence; electronic display interfaces, namely, monitors for the display of information obtained from scientific equipment; silicon chips; DNA chips for scientific and research use; analyte detector chips for scientific and research use; biosensor chips; Nanopore sensors for scientific testing and research purposes

### **Class 10**

(2) Medical and veterinary apparatus for biological, chemical, biochemical, DNA, RNA, protein and molecular analysis, namely, automated electronic devices for sequencing DNA, RNA, and other small molecules for the purposes of analysing test samples comprising biological, chemical, biochemical, DNA, RNA, proteins and other small molecules for medical and veterinary purposes; portable medical and veterinary apparatus for biological, chemical, biochemical, DNA, RNA, protein and molecular analysis namely, automated electronic devices for sequencing DNA, RNA, and other small molecules for the purposes of analysing test samples comprising biological, chemical, biochemical, DNA, RNA, proteins and other small molecules for medical and veterinary purposes; automated electronic devices for sequencing DNA, RNA and other small molecules for the purposes of detecting and diagnosing pathogenic, infectious, psychiatric, oncogenic, metabolic, genetic, respiratory, genitourinary, digestive, inflammatory, autoimmune, reproductive, hepatic, central nervous system, degenerative and cardiovascular diseases and conditions; portable automated electronic devices for sequencing DNA, RNA and other small molecules for the purposes of detecting and diagnosing pathogenic, infectious, psychiatric, oncogenic, metabolic, genetic, respiratory, genitourinary, digestive, inflammatory, autoimmune, reproductive, hepatic, central nervous system, degenerative and cardiovascular diseases and conditions; testing apparatus namely, automated electronic devices for sequencing DNA, RNA and other small molecules for medical and veterinary purposes; portable testing apparatus namely, automated electronic devices for sequencing DNA, RNA and other small molecules for medical or veterinary purposes; empty cartridges for test samples, namely, cartridges for use with concentrates and solutions in solid or liquid form for sequencing and synthesising chemical compounds, small molecules, genomes, DNA, RNA and other nucleic acids, oligosaccharides, proteins and peptides, for medical purposes; reaction units containing chemical reagents for medical testing purposes; Nanopore sensing devices for medical and veterinary purposes

### **Services**

#### **Class 42**

(1) Scientific and technological services and research and design relating thereto namely, consultation, research and design services relating to automated systems and instruments for direct electrical detection and analysis of molecules for use in the field of genomics, protein

analysis, molecular analysis, life sciences, healthcare, national security and military defence; industrial analysis and research services in the fields of genomics, protein analysis, molecular analysis, life sciences, healthcare, national security and military defence; scientific research in the fields of biology, chemistry, biochemistry, bacteriology, medicine and veterinary science; biological, chemical, biochemical, bacteriological, DNA, RNA, protein, polynucleic acid and molecular analysis services; synthesis of chemical compounds, small molecules, genomes, DNA, RNA and other nucleic acids, oligosaccharides, proteins and peptides for scientific purposes; genome, DNA, RNA and nucleic acid, oligosaccharide, protein and peptide synthesising services for scientific purposes; synthesising services of chemical compounds and small molecules, genomes, DNA, RNA and other nucleic acids, oligosaccharides, proteins and peptides for scientific testing purposes; DNA and RNA and polynucleic acid sequencing services; protein sequencing services; DNA and polynucleic acid testing services; genome sequencing services; Analysis and evaluation of biological, bacteriological, chemical, biochemical, DNA, RNA, protein, polynucleic acid and molecular data not for medical treatment or diagnostic purposes, namely, scientific and medical data obtained from scientific tests and experiments; analysis of scientific results obtained from sequencing DNA, RNA and other polynucleic acids; biological, bacteriological, chemical, biochemical, DNA, RNA, protein, polynucleic acid and molecular analysis and evaluation services; DNA and RNA and polynucleic acid and protein sequencing, analysis and evaluation services; genome sequencing services and the analysis and evaluation of data resulting therefrom; provision of reports about scientific results obtained from sequencing DNA, RNA and other polynucleic acids; research and development services in the fields of chemistry, biology, biotechnology, genomics, pharmaceutical development, medical research and nanotechnology; technical analysis and evaluation services in the fields of chemistry, biology, biotechnology, genomics, pharmaceutical development, medical research and nanotechnology; application service provider (ASP) services featuring computer software for use in the analysis of scientific and medical records obtained from sequencing DNA, RNA and other polynucleic acids and installed onto medical image processors, computers, tablet computers and handheld mobile digital electronic devices; scientific research for medical and veterinary purposes in the field of DNA, RNA and other polynucleic acids

#### **Class 44**

(2) Synthesis of chemical compounds, small molecules, genomes, DNA, RNA and other nucleic acids, oligosaccharides, proteins and peptides for medical purposes; genome, DNA, RNA and nucleic acid, oligosaccharide, protein and peptide synthesising services for medical purposes; analysis of medical results obtained from sequencing DNA, RNA and other polynucleic acids; provision of reports about medical results obtained from sequencing DNA, RNA and other polynucleic acids

#### **Claims**

Priority Filing Date: January 25, 2018, Country or Office: UNITED KINGDOM, Application No: 00003285346 in association with the same kind of goods and in association with the same kind of services

**Application Number** 1,912,716  
**Language of Application** English

**Filing Date** 2018-08-01

## APPLICANT DETAILS

### Applicant

3744515 CANADA INC.  
3300 Gregoire Rd.  
Russell  
ONTARIO  
K4R1E5

## TRADEMARK DETAILS

# Maxfactor.ca

### Trademark Type

Word

### Services

#### Class 35

(1) Advertising services for others, Internet advertising, the promotion of products and services through the internet for others, namely providing internet marketing, online advertising, search engine marketing and optimization, lead generation, lead management, inventory marketing, and performance analytics services to third parties; online advertising, search engine optimization, lead generation, lead management, inventory marketing, and performance analytics; .

#### Class 38

(2) Providing access to online newsletters in the field of internet marketing to third parties; providing access to online newsletters in the field of internet marketing to third parties;

#### Class 41

(3) Training services in the field of internet marketing and website management for third parties.

#### Class 42

(4) Design, creation, hosting, maintenance and optimization of online websites for third parties.

**Application Number** 1,914,805  
**Language of Application** English

**Filing Date** 2018-08-14

## **APPLICANT DETAILS**

**Applicant**  
DyTerra Corporation  
7355 Wilkes Ave  
Headingley  
MANITOBA  
R4H1B8

## **TRADEMARK DETAILS**

**MicroCote**

**Trademark Type**  
Word

**Goods**

**Class 07**  
agricultural land fertilizing equipment



**Application Number** 1,919,259  
**Language of Application** English

**Filing Date** 2018-09-11

## APPLICANT AND AGENT DETAILS

### Applicant

TOURBIERES LAMBERT INC./LAMBERT  
PEAT MOSS INC.  
106 Chemin Lambert  
Rivière-Ouelle  
QUEBEC  
G0L2C0

### Agent

BENOÎT & CÔTÉ INC.  
560 boul. Crémazie Est, 3e étage, Montréal,  
QUEBEC, H2P1E8

## TRADEMARK DETAILS

**Trademark Type**  
Design

**Visual Representation**

**ECOPEAT PLUS+**

### Goods

**Class 31**

Horticultural product, namely, peat moss to promote healthy plant growth.

**Application Number** 1,923,146  
**Language of Application** English

**Filing Date** 2018-10-02

## APPLICANT AND AGENT DETAILS

### Applicant

Smart Film Inc.  
12-4696 Bartlett Rd  
Beamsville  
ONTARIO  
L0R1B1

### Agent

RIDOUT & MAYBEE LLP  
5500 North Service Road, Suite 101,  
Burlington, ONTARIO, L7L6W6

## TRADEMARK DETAILS

### Trademark Type

Design

### Visual Representation



### Goods

#### Class 11

Laminated plastic films for use on windows.

### Services

#### Class 35

(1) Sales of laminated plastic films for use on windows.

#### Class 37

(2) Installation services of laminated plastic films for use on windows.

**Application Number** 1,928,344  
**Language of Application** English

**Filing Date** 2018-11-01

## APPLICANT AND AGENT DETAILS

### Applicant

A & Z Inc.  
5-4325 Harvester Rd  
Burlington  
ONTARIO  
L7L5M4

### Agent

RUPINDER HANS  
(Hans Law Firm), 3400 American Drive,  
Mississauga, ONTARIO, L4V1C1

## TRADEMARK DETAILS

### Trademark Type

Design

### Visual Representation



### Services

#### Class 41

(1) day camp services; providing recreational areas in the nature of play areas for children

#### Class 43

(2) rental of function rooms for birthday parties; rental of rooms for social functions

**Application Number** 1,930,734  
**Language of Application** French

**Filing Date** 2018-11-15

## APPLICANT AND AGENT DETAILS

### Applicant

Les Abeilles Service de Conditionnement Inc.  
12910 Boul Métropolitain E  
Montréal  
QUÉBEC  
H1A4A7

### Agent

MARIE LAURE LECLERCQ  
(DE GRANDPRE, CHAIT), 800 René-  
Lévesque Blvd. ouest, 26ième étage, Montréal,  
QUÉBEC, H3B1X9

## TRADEMARK DETAILS

### Trademark Type

Design

### Visual Representation



**abeillesbusybees**

### Services

#### Class 39

(1) Packaging, bagging and labelling of goods in the food, cosmetic and pharmaceutical fields.

#### Class 40

(2) Assembling and bonding of packaging for the goods of others in the food, cosmetic and pharmaceutical fields.

**Application Number** 1,931,474  
**Language of Application** English

**Filing Date** 2018-11-20

## APPLICANT AND AGENT DETAILS

### Applicant

Canadian Association of Professional  
Immigration Consultants  
407-245 Fairview Mall Dr  
Toronto  
ONTARIO  
M2J4T1

### Agent

STACEY L. BOTHWELL  
(SISKINDS LLP), 275 Dundas Street, Unit 1,  
London, ONTARIO, N6B3L1

## TRADEMARK DETAILS

### Trademark Type

Design

### Visual Representation

Four Pillars: Education, Information, Lobbying, Recognition  
quatre piliers: études-formation, l'information, le lobbying, et la reconnaissance  
Agnitio, Educatio, Informatio, Advocatio

### Foreign Character Translation

The translation provided by the applicant of the Latin words AGNITIO, EDUCATIO, INFORMATIO, ADVOCATIO is RECOGNITION, EDUCATION, INFORMATION, LOBBYING.

### Services

#### Class 41

(1) Educational and training services namely conducting seminars, conferences and workshops for the professional development of immigration consultants.

#### Class 45

(2) Association services namely the operation of a trade association representing and promoting the interests of immigration consultants; Government lobbying and legislative monitoring services namely lobbying Federal and Provincial governments on issues which affect the immigration consultancy industry

**Application Number** 1,931,560  
**Language of Application** English

**Filing Date** 2018-11-20

## APPLICANT AND AGENT DETAILS

### Applicant

Movingdots GmbH  
Llyodstrasse 4-6  
28217 Bremen  
GERMANY

### Agent

MBM INTELLECTUAL PROPERTY AGENCY  
275 SLATER STREET, 14TH FLOOR,  
OTTAWA, ONTARIO, K1P5H9

## TRADEMARK DETAILS

# MOVINGDOTS

### Trademark Type

Word

### Goods

#### Class 09

Signalling and control apparatus and instruments, namely, signal processors and remote controls for wireless transmission devices, namely vehicle tracking devices; apparatus and software for recording, transmission, reception and reproduction of data about the location and movements of vehicles; computer hardware for data processing; software for location tracking of vehicles and goods and location monitoring of vehicles and goods; software for computers, on-board computers, smartphones and tablets for recording, transmission, reception and reproduction of data in the field of automotive and mobility sector; single-board computers; software and applications for telematic in-vehicle communication and vehicle navigation and tracking systems; software and applications for processing, evaluating, managing, storing, transferring, transmitting, receiving data and information, in particular data about and information on the location and movements of vehicles, freight; downloadable software and applications for warning and alerting about movement of vehicles; downloadable software for vehicle and fleet management; software and applications for the autonomous control and remote control of vehicles

### Services

#### Class 35

(1) Business management; business administration; business consulting services in the fields of risk management, insurance and reinsurance; business management consulting services in the fields of risk management, insurance and reinsurance; collecting, systematizing and compiling data in a database in the fields of vehicle tracking, vehicle monitoring, risk management, insurance and reinsurance; business assistance, namely, outsourcing services in the fields of vehicle tracking, vehicle monitoring, risk management, insurance and reinsurance; business project management; business consultancy and business project management in the fields of data processing, transmission, systematization and telematics; managing a database of insurance-relevant information and data

#### Class 36

(2) Insurance services, reinsurance services; financial services, namely, financial consultation, financial information, financial management, financial research, financial planning in the fields of

insurance and reinsurance; consultancy services, consultancy and information in the fields of risk analysis, risk modelling, risk transfer and risk management in the fields of insurance and reinsurance; consultancy services in the fields of risk analysis, risk modelling, risk transfer and risk management; consultancy services and information in the field of insurance telematics; consultancy services and information relating to insurance models linked to driving behavior and relating to property, casualty, life and health insurance models linked to information transmitted by telematics systems; providing financial information in the field of insurance from an online computer database or a global communications network; insurance claims adjustment and settlement services; administering insurance policies

### **Class 38**

(3) Telecommunication services, namely, audio teleconferencing, electronic transmission of messages and data for traffic navigation and tracking; information and data transmission via electronic communication networks and satellite transmission of messages and data for traffic navigation and monitoring; transmission of information and data in telematic systems via cellular and wireless communications networks for vehicle navigation and tracking; electronic transmission of information and data on locations and movements of vehicles and cargo; providing access to mobile Internet platforms

### **Class 42**

(4) Scientific and technological research services in the field of mobility and telematics solutions as well as research and design relating thereto; industrial analysis and research in the field of computer hardware and software; scientific research services, namely, computer-aided, industrial and scientific analysis of data; design and development of software-based calculation models and databases for vehicle tracking and vehicle monitoring in the field of insurance and reinsurance; providing temporary use of non-downloadable computer software; providing cloud storage facilities for use as a data center for others; design, development, programming, installation, configuration, maintenance, updating, repair, rental and web hosting of computer software and applications of others; consultancy relating to software applications for others; design, development, programming, installation, configuration, maintenance, updating, repair, rental and web hosting of computer software applications for others; processing, evaluating, managing, storing, transmitting, transfer, reception of data and information, in particular data and data information on vehicle communication and vehicle navigation, monitoring and tracking on the location and movements of vehicles and cargo, for software and applications for telematic systems, for software and applications for alerting and alerting on the movement of vehicles, for software and applications for vehicle and fleet management namely in-vehicle communication and vehicle navigation, monitoring and tracking systems, and for software and applications for the autonomous control and remote control of vehicles; analysis of computer systems; planning, design and implementation of telematic systems and consulting in this regard; services for protection against unauthorized access to IT systems, namely computer virus protection services

### **Claims**

Priority Filing Date: June 18, 2018, Country or Office: GERMANY, Application No: 302018014917 in association with the same kind of goods and in association with the same kind of services

**Application Number** 1,933,417  
**Language of Application** English

**Filing Date** 2018-11-30

## APPLICANT AND AGENT DETAILS

### Applicant

Suncha Bamboo&Wood Technology Co.,Ltd  
Baizhang village, Baizhang Town  
Yuhang District, Hangzhou City  
Zhejiang Province  
CHINA

### Agent

ANITA MAR  
dba Trademark Angel, Suite 521, 6-2557  
Dougall Avenue, Windsor, ONTARIO, N8X1T5

## TRADEMARK DETAILS

### Trademark Type

Design

### Visual Representation

The logo for 'Suncha' features a stylized letter 'S' on the left. The 'S' is formed by two black curved lines that meet at the top and bottom, creating a shape reminiscent of a leaf or a drop. Two small green leaves are attached to the right side of the 'S'. To the right of the 'S' is the word 'uncha' in a lowercase, rounded, sans-serif font. The entire logo is rendered in black, with the green leaves providing a color accent.

### Colour Claim

Colour is claimed as a feature of the trademark. the text "Suncha" is written in black. The two half circles symbolize the "s" letter and create a leaf shape colored green. On the right side of the letter "S" two leaves colored in green.

### Goods

#### Class 03

(1) cotton swabs for cosmetic purposes

#### Class 08

(2) cutlery; fertilizer scoops; fish scoops; rice scoops; sugar scoops; table forks; table knives; tablespoons

#### Class 20



(3) chairs; plate racks; tables

**Class 21**

(4) beverage containers; biodegradable trays; bowls; chopsticks; coffee scoops; compostable and biodegradable plates, bowls, cups and trays; containers for ice; cooking skewers; cooking skewers of metal; cooking utensils; crumb trays; cutlery trays; cutting boards; cutting boards for the kitchen; dispensers for paper towels; dog food scoops; food storage containers; hand-operated pepper mills; heat-insulated containers for beverages; ice cream scoops; Japanese style cooked rice scoops [shamoji]; lunch boxes; meal trays; paper and plastic cups; paper trays; potholders; pots; rolling pins; scoops for pet waste; serving trays; table plates; take-out food containers; tart scoops; thermal insulated containers for food or beverages; toilet paper dispensers; toilet paper holders; toothpicks; trash cans; waste paper baskets

**Application Number** 1,935,643  
**Language of Application** English

**Filing Date** 2018-12-12

## APPLICANT AND AGENT DETAILS

### Applicant

CANOPY GROWTH CORPORATION  
1 Hershey Drive  
Smiths Falls  
ONTARIO  
K7A0A8

### Agent

FASKEN MARTINEAU DUMOULIN LLP  
333 BAY STREET, SUITE 2400, BAY  
ADELAIDE CENTRE, BOX 20, TORONTO,  
ONTARIO, M5H2T6

## TRADEMARK DETAILS

# FIRST + FREE

### Trademark Type

Word

### Goods

#### Class 03

(1) Cosmetics, makeup, makeup removers, eye creams, skin care preparations, skin creams, skin serums, skin oils, skin emollients, skin lotions, non-medicated skin care treatment preparations, facial and body skin masks, skin soap, body powders for personal use, bath and shower soaps, liquid soaps for hands, face and body; face and body lotions, face and body milk, face lotion, hand cream, hand lotions, bath gels, bath lotions, non-medicated bath salts, bath scrubs, bath oils, bubble bath, bath additives, bath herbs, bath bombs, nail enamel and nail care preparations, nail polish remover, lip care preparations, lip conditioners, lip glosses, sun skin care preparations, sun screen preparations, sun block preparations, self-tanning preparations, after-sun skin soothing and moisturizing preparations, pre-shave and after shave lotions, pre-shave and after shave creams, pre-shave and after shave balms, pre-shave and after shave splashes, pre-shave and after shave gels, personal deodorants and antiperspirants, hair care preparations, hair oils, hair masks, scalp treatments, hair sunscreen preparations, non-medicated preparations for the care of the scalp, essential oils for aromatherapy, essential oils for perfumery and personal use, scented oils for personal use, namely scented oils used to produce aromas when heated, massage creams; massage oils; hemp derivatives, cannabis and cannabis derivatives and infused products, not for medicinal use, namely oil extracts, oils, extracts, pastes, balms, salves, concentrates, lotions, sprays, ointments, tonics, liquids, topical skin creams, lotions and gels for cosmetic and toiletry purposes

#### Class 05

(2) Medicated skincare products containing cannabis or cannabis derivatives for the treatment of various conditions namely psoriasis, cystic acne, acne, eczema, scars and wounds; topical skin creams, bar and liquid soaps, bath additives, bath herbs, bath oils, body creams, body oils, face and body lotions, face and body milk, face lotion, skin care preparations containing hemp, hemp derivatives, cannabis and derivatives of cannabis for the treatment of various conditions namely psoriasis, cystic acne, acne, eczema, scars and wounds; pharmaceutical cannabis and cannabis derivative tablets, capsules, suppositories, tampons, skin patches, sublingual doses, and mucous membrane doses, sprays and liquids, transdermal patches and oral sprays; botanical, herbal,

nutraceutical, dietary and nutritional supplements, natural health products and natural solutions namely cannabis infused foods and beverages for medical purposes for general health and well-being; botanical, herbal, nutraceutical, dietary and nutritional preparations containing plant extracts and plant-derived nutrients namely, cannabidiol derived from hemp for medicinal purposes, hemp oil for medicinal purposes, hemp-based dietary supplements, hemp-based nutritional supplements; hemp-based dietary supplements, hemp-based dietary supplements for the promotion of weight loss; cannabis derivatives namely dietary supplement drinks for general health and wellbeing. (2) Veterinary preparations containing hemp, hemp derivatives, cannabis and cannabis derivatives for the treatment of diseases and disorders namely, long-term neurogenic pain, muscle spasms, muscle cramps, reduced appetite, weight loss, treatment of pain and the induction of sedation, anxiety relief, and pain relief during therapeutic and diagnostic procedures

### **Class 25**

(3) Clothing namely casual clothing, sport clothing, dress clothing; t-shirts, shirts, sweatshirts, hoodies, tank tops, jackets, lab coats, dresses, skirts, sweatpants, pants, undergarments, scarves, belts, gloves; footwear namely casual footwear, athletic footwear, beach footwear, sandals, rain footwear, golf footwear; headwear namely hats, caps, and cap visors, toques

### **Class 29**

(4) Hemp, hemp protein powder, hulled hemp hearts, hemp oil for food, prepared hemp seeds, flour containing hulled hemp, hemp-based cereal, hemp milk, hemp-based snack foods namely hemp and granola-based snack foods, and other hemp products, namely hemp-based bars, protein bars, granola bars; food products and edibles containing hemp, hemp derivatives, cannabis, cannabis extracts, cannabis resins, cannabis oils, cannabis gum, cannabis waxes, cannabis butters, and cannabis hashes and other derivatives namely fruit bars

### **Class 30**

(5) Food products and edibles containing hemp, hemp derivatives, cannabis, cannabis extracts, cannabis resins, cannabis oils, cannabis gum, cannabis waxes, cannabis butters, and cannabis hashes and other derivatives namely teas, cakes, cereal bars, cookies, pastries, brownies, muffins, cupcakes, bread, buns, biscuits, pastries, chocolate, chocolate confectionery and bars, chewing gum, energy bars, granola based bars, multigrain-based snack food bars, meal replacement bars, sugar confectionery, gummies, hard candies, mints, crackers, granola, cereal, ice cream, candies, chewing gum, chips; hemp derivatives, cannabis and cannabis derivatives and infused products, not for medicinal use, namely teas and coffees; hemp beverages namely cocoa-based beverages, coffee-based beverages, non-alcoholic tea-based based beverages, herbal tea-based beverages

### **Class 31**

(6) Cannabis in its various forms namely live cannabis plants, unprocessed cannabis seeds, fresh cannabis, live plants and seeds for horticultural purposes; hemp in various forms, namely fresh hemp. (2) Food and edible treats for pets containing hemp, hemp derivatives, cannabis, cannabis extracts, cannabis resins, cannabis oils, cannabis gum, cannabis waxes, cannabis butters, and cannabis hashes and other cannabis derivatives

### **Class 32**

(7) Non-alcoholic beverages infused with hemp, hemp derivatives, cannabis, cannabis extracts, cannabis resins, cannabis oils, cannabis tinctures, cannabis waxes and other cannabis derivatives including smoothies, fruit beverages and fruit juices, carbonated soft drinks, and energy drinks and waters, protein supplement shakes, sports recovery drinks, isotonic drinks, meal replacement drinks; hemp smoothies, hemp fruit beverages, hemp fruit juices, carbonated soft drinks with

hemp, hemp energy drinks; hemp derivatives, cannabis and cannabis derivatives and infused products, not for medicinal use, namely infused beverages namely bottled water containing hemp; carbonated beverages containing hemp; cider flavoured beverages containing hemp; iced fruit beverages containing hemp; flavored waters containing hemp; honey-based beverages containing hemp; mineral and aerated waters containing hemp; protein-enriched sports beverages containing hemp; sports drinks containing hemp; vegetable-based beverages containing hemp

### **Class 34**

(8) Cannabis smoking and vaping accessories for the preparation, use and storage of cannabis namely water pipes, vaporizers, bongs, bowls, hookah, rolling papers, blunts, roach clips, pill bottles, lighters, torches, ashtrays, grinders, weighing scales; smokers' articles, namely, smoking pipes, pouches for use with cannabis, lighters for smokers; smokers' articles, namely, oral vaporizers for smokers; cannabis and marijuana for recreational use for smoking and vaping; derivatives of cannabis for smoking and vaping; hemp and hemp derivatives for smoking and vaping; hemp derivatives, cannabis and cannabis derivatives and infused products, not for medicinal use, namely, oil extracts, oils, extracts, tinctures, resins, waxes, hashes, and concentrates for smoking and vaporizing; hemp derivatives, cannabis and cannabis derivatives and infused products, not for medicinal use, namely, lotions, sprays, ointments, tonics, liquids, powders, topical skin creams, lotions and gels, pills, tablets, capsules, suppositories, tampons, skin patches, sublingual doses, mucous membrane doses, sprays and liquids, transdermal patches and oral sprays used as an alternative to smoking and vaporizing; dried cannabis

### **Services**

#### **Class 35**

(1) Retail, online and wholesale sale in the following fields namely retail, online and wholesale sale of hemp, hemp derivatives, recreational and medical cannabis, recreational and medical marijuana, cannabis derivative products, cannabis infused products namely food, beverages, skin care products, pharmaceutical products, natural health products, and accessories, namely pipes, rolling papers, water pipes, grinders, vaporizers, scales, bongs, bowls, hookah, blunts, roach clips, lighters, torches, ashtrays. Development, management and operation of businesses for others namely advisory services in the healthcare industry, the medical marijuana and cannabis industry, the marijuana and cannabis industry and high-technology industry; advice and information concerning commercial business management; business management supervision; business planning; Membership club services in the nature of providing discounts to customers and customer and patient loyalty programs; providing online directory information services in the field of medical cannabis, medical marijuana and related, infused and derivative products and hemp, hemp derivatives and products containing hemp and hemp derivatives; distributorship in the field of marijuana and cannabis; import and export of marijuana and cannabis and their related and derivative products to Government approved sources in other countries

#### **Class 38**

(2) Providing an online bulletin board for publishing of information about benefits of hemp, medical marijuana and cannabis, research related to hemp, medical cannabis and marijuana and for users to provide commentary about the content or about subjects relating thereto via a website; Providing an online bulletin board for registered users to participate in discussions, provide and obtain feedback from other registered users, form virtual communities, and engage in social networking in the field of hemp, medical marijuana and medical cannabis via a website

#### **Class 40**

(3) processing of marijuana and cannabis and medical cannabis

**Class 41**

(4) Educational services and patient educational services, namely providing audio, visual and print materials, seminars, workshops, classes, training sessions, computer applications and community events all in the field of healthcare, hemp, cannabis, medical marijuana, medical cannabis, cannabis strains, pharmaceutical products, natural health products, skincare products and therapeutic skincare products, case studies and patient information

**Class 42**

(5) Scientific research and development in the field of hemp, hemp derivatives, medical marijuana, medical cannabis, marijuana, cannabis, their related products and derivatives for the development of therapeutics, and to target specific symptoms, diseases, illnesses and disorders; development of marijuana and cannabis

**Class 44**

(6) Operation of a medical cannabis dispensary; Providing information in the field of medical marijuana and medical cannabis, their related strains, cannabis infused products, related products and derivative products, hemp, hemp derivatives and products containing hemp and hemp derivatives via a website; providing information on research related to medical marijuana and medical cannabis via a website; providing information featuring the ratings, reviews and recommendations on medical cannabis, medical marijuana and medical cannabis products and cannabis infused, related and derivative products, hemp and hemp derivatives and products containing hemp and hemp derivatives via a website; providing information regarding indications and effects of particular medical cannabis strains via a website; Medical consulting services including in the fields of medical use of marijuana, cannabis and their derivatives and infused products and hemp and hemp derivatives; Cultivating, breeding, growing, and production of marijuana and cannabis

**Application Number** 1,935,760  
**Language of Application** English

**Filing Date** 2018-12-13

## APPLICANT AND AGENT DETAILS

### Applicant

FENIX OUTDOOR DEVELOPMENT AND CSR  
AG  
Industriestraße 6  
6300 Zug  
SWITZERLAND

### Agent

CASSELS BROCK & BLACKWELL LLP  
SCOTIA PLAZA, SUITE 2100, 40 KING  
STREET WEST, TORONTO, ONTARIO,  
M5H3C2

## TRADEMARK DETAILS

### Trademark Type

Design

### Visual Representation

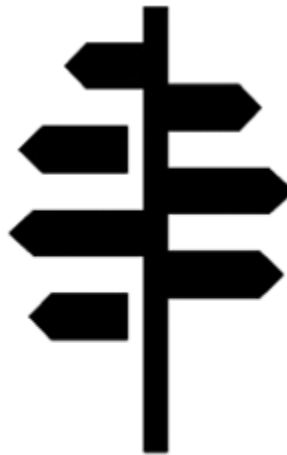

# ROYAL ROBBINS

### Goods

#### Class 18

(1) Luggage, bags, wallets and other carriers, in particular all-purpose carrying bags, Backpacks, Belt bags and hip bags, Brief cases, Camping bags, Card cases [notecases], Carrying cases for documents, Casual bags, Daypacks, Duffel bags, Handbags, Hiking bags, Key holders, namely key pouches and key wallets, Pocket wallets, Rucksacks, School bags, Small backpacks, Sport bags, Toiletry bags sold empty, Tote bag, Travel baggage, Travel bags, Travel luggage, Waist bags, Waterproof bags, namely, waterproof hiking bags, waterproof rucksacks, waterproof daypacks, waterproof tote bags, waterproof luggage, waterproof duffel bags, waterproof backpacks, waterproof grip bags, waterproof travel bags, waterproof sports bags, waterproof all-

purpose carrying bags, waterproof weekend bags; Purses; Leather and imitations of leather, in particular Leather bags and wallets, Traveling luggage sets and Travelling bags [leatherware] and shoulder belts of leather.

**Class 22**

(2) Canvas bags for storage.

**Class 25**

(3) Clothing, in particular Sweaters, T-shirts, Trousers, Arm warmers [clothing], Cardigans, Down jackets, Down vests, Dresses, Fleece, namely shirts, jackets, pants, vests, Leg warmers, Knitwear [clothing], namely knitted sweaters, knitted tops, knitted shirts, Gloves, Belts [clothing], Belts made from imitation leather, Clothing made of imitation leather, namely shirts, jackets, pants, Clothing made of leather, namely shirts, jackets, pants, Children's clothing, Pants, Shorts, Parkas, Jackets, Anoraks, Pullovers, Scarfs, Shell jackets, Shirts, Pique shirts, Sweat-absorbent underclothing, Waterproof and windproof clothing, namely jackets and pants, Underwear; Suspenders; Headgear, in particular Caps, Hats and Beanies; Footwear, in particular Hiking boots and shoes, Hunting boots, Lace boots, Mountaineering shoes and boots, Walking shoes and boots, Waterproof boots and shoes, Winter boots, casual footwear, Children's footwear, Climbing footwear, Trekking boots; Gaiters; uppers for shoes and boots; Socks; Shoe soles; Insoles; Intermediate soles.

**Claims**

Priority Filing Date: June 14, 2018, Country or Office: EUIPO (EU), Application No: 017918234 in association with the same kind of goods

**Application Number** 1,935,762  
**Language of Application** English

**Filing Date** 2018-12-13

## **APPLICANT AND AGENT DETAILS**

### **Applicant**

FENIX OUTDOOR DEVELOPMENT AND CSR  
AG  
Industriestrasse 6  
6300 Zug  
SWITZERLAND

### **Agent**

CASSELS BROCK & BLACKWELL LLP  
SCOTIA PLAZA, SUITE 2100, 40 KING  
STREET WEST, TORONTO, ONTARIO,  
M5H3C2

## **TRADEMARK DETAILS**

### **Trademark Type**

Design

### **Visual Representation**

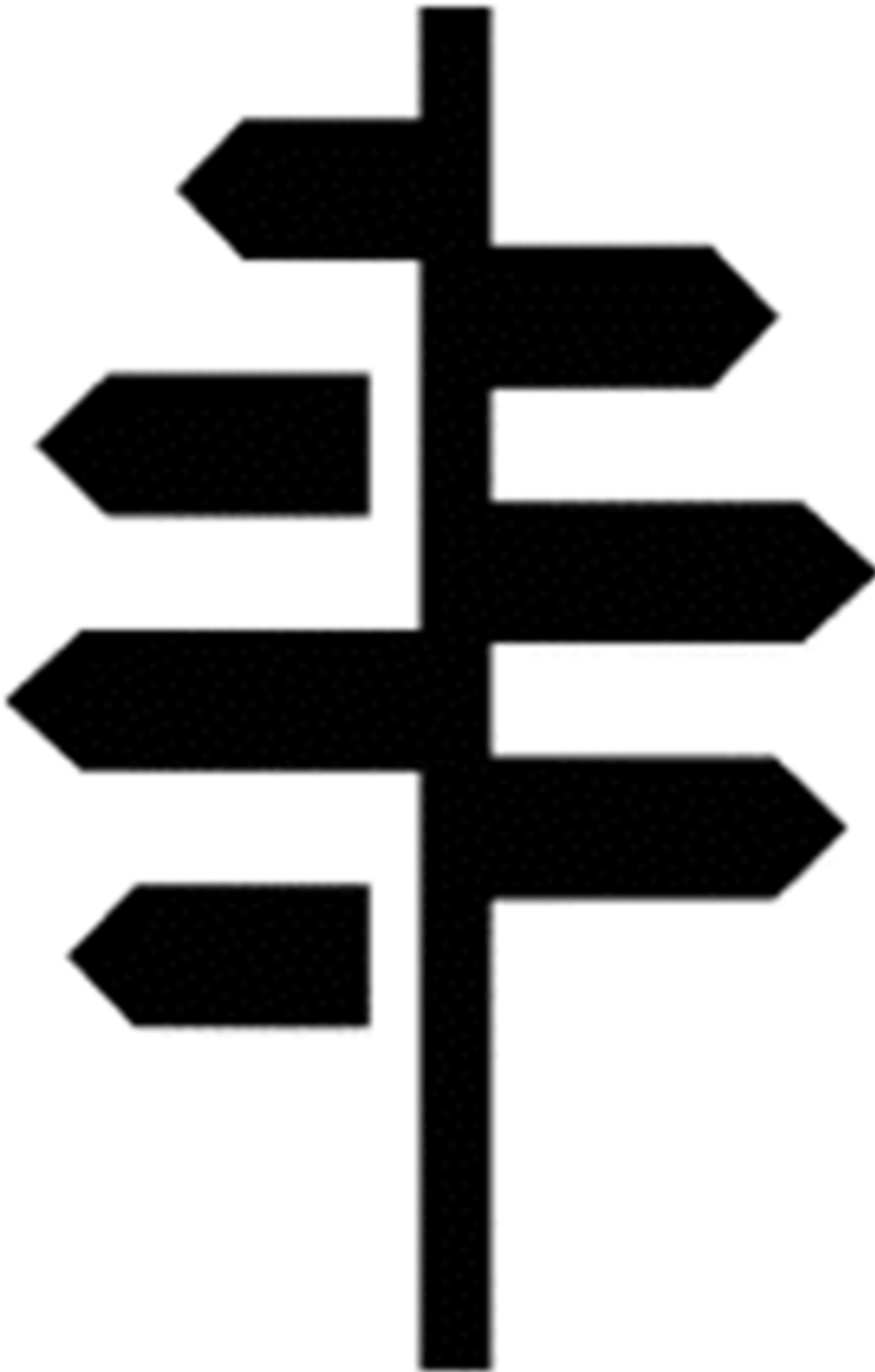

**Goods****Class 18**

(1) Luggage, bags, wallets and other carriers, in particular all-purpose carrying bags, Backpacks, Belt bags and hip bags, Brief cases, Camping bags, Card cases [notecases], Carrying cases for documents, Casual bags, Daypacks, Duffel bags, Handbags, Hiking bags, Key holders, namely key pouches and key wallets, Pocket wallets, Rucksacks, School bags, Small backpacks, Sport

bags, Toiletry bags sold empty, Tote bag, Travel baggage, Travel bags, Travel luggage, Waist bags, Waterproof bags, namely, waterproof hiking bags, waterproof rucksacks, waterproof daypacks, waterproof tote bags, waterproof luggage, waterproof duffle bags, waterproof backpacks, waterproof grip bags, waterproof travel bags, waterproof sports bags, waterproof all-purpose carrying bags, waterproof weekend bags; Purses; Leather and imitations of leather, in particular Leather bags and wallets, Traveling luggage sets and Travelling bags [leatherware] and shoulder belts of leather.

**Class 22**

(2) Canvas bags for storage.

**Class 25**

(3) Clothing, in particular Sweaters, T-shirts, Trousers, Arm warmers [clothing], Cardigans, Down jackets, Down vests, Dresses, Fleece, namely shirts, jackets, pants, vests, Leg warmers, Knitwear [clothing], namely knitted sweaters, knitted tops, knitted shirts, Gloves, Belts [clothing], Belts made from imitation leather, Clothing made of imitation leather, namely shirts, jackets, pants, Clothing made of leather, namely shirts, jackets, pants, Children's clothing, Pants, Shorts, Parkas, Jackets, Anoraks, Pullovers, Scarfs, Shell jackets, Shirts, Pique shirts, Sweat-absorbent underclothing, Waterproof and windproof clothing, namely jackets and pants, Underwear; Suspenders; Headgear, in particular Caps, Hats and Beanies; Footwear, in particular Hiking boots and shoes, Hunting boots, Lace boots, Mountaineering shoes and boots, Walking shoes and boots, Waterproof boots and shoes, Winter boots, casual footwear, Children's footwear, Climbing footwear, Trekking boots; Gaiters; uppers for shoes and boots; Socks; Shoe soles; Insoles; Intermediate soles.

**Claims**

Priority Filing Date: June 14, 2018, Country or Office: EUIPO (EU), Application No: 017918229 in association with the same kind of goods

**Application Number** 1,936,592  
**Language of Application** English

**Filing Date** 2018-12-17

## APPLICANT AND AGENT DETAILS

### Applicant

Aquafortus Technologies Limited  
Level 1, 57 Symonds Street, Grafton  
Auckland 1010  
NEW ZEALAND

### Agent

GOWLING WLG (CANADA) LLP  
550 BARRARD STREET, SUITE 2300,  
VANCOUVER, BRITISH COLUMBIA, V6C2B5

## TRADEMARK DETAILS

### Trademark Type

Design

### Visual Representation



### Goods

#### Class 01

(1) Purification chemicals, namely chemicals for use in the purification of water and chemicals for use in the purification of solvents; chemical preparations in the nature of filtering materials for use in water purification and for use in the purification of solvents; water purifying chemicals; chemical water treatment preparations; water treatment preparations (chemical); chemicals for treating water; chemicals for use in purifying water; chemicals for use in the purification of water; chemicals for the purification of water; chemical preparations for use in water purification; chemical preparations for the treatment of water; chemical preparations for use in water treatment; chemical products, namely, chemicals for use in the treatment of water; chemical preparations in the nature of filtering materials for use in water purification and for use in the purification of solvents; chemicals for use in clarifying water; chemicals for use in clarifying water, namely, chemicals for use in water treatment; chemicals for use in cleaning water; chemicals for use in cleaning water, namely, chemicals for use in water treatment; chemicals for use in clearing water; chemicals for use in clearing water, namely, chemicals for use in water treatment; chemical additives for use in the cleaning of water; chemical additives for use in the cleaning of water, namely, chemicals for use in water treatment; chemicals for use in the purification of solvents; filter aids for liquid purification, namely, chemical preparations for use in water purification and for use in the purification of solvents;

**Class 11**

(2) Water filters for industrial purposes; filters for drinking water; filters for water purifiers; domestic water filtering units; drinking water filters; industrial waste water purification plants; municipal water purification machines; sterilizers for water treatment; tap-water purifying apparatus; water distillation units; water filtering units for domestic use; water filtering units for industrial use; water purification machines for domestic use; water purifiers for household purposes; water purifiers for industrial purposes; water treatment plant filters; purification installations for sewage; rainwater purification installations; water conditioning units; water distillation units.

**Services****Class 40**

Treatment of materials in the nature of water; chemical processing of liquids by solvent exchange; treatment of chemical waste; chemical recycling of waste products; demineralisation of water; water purification and treatment; treatment of liquids, namely water; treatment of water; treatment of waste water; waste water treatment; water treatment; industrial treatment of effluent; treatment of effluent, namely, waste water treatment services; industrial treatment of effluents, namely, water treatment services; treatment of industrial waste; rental of water treatment equipment; waste water reprocessing; waste water treatment services; water and sewer management; water recycling; water treating.

**Claims**

Priority Filing Date: June 28, 2018, Country or Office: NEW ZEALAND, Application No: 1096592 in association with the same kind of goods and in association with the same kind of services

**Application Number** 1,937,085  
**Language of Application** English

**Filing Date** 2018-12-19

## **APPLICANT AND AGENT DETAILS**

### **Applicant**

Aquafortus Technologies Limited  
Level 1, 57 Symonds Street, Grafton  
Auckland 1010  
NEW ZEALAND

### **Agent**

GOWLING WLG (CANADA) LLP  
550 BARRARD STREET, SUITE 2300,  
VANCOUVER, BRITISH COLUMBIA, V6C2B5

## **TRADEMARK DETAILS**

### **Trademark Type**

Design

### **Visual Representation**

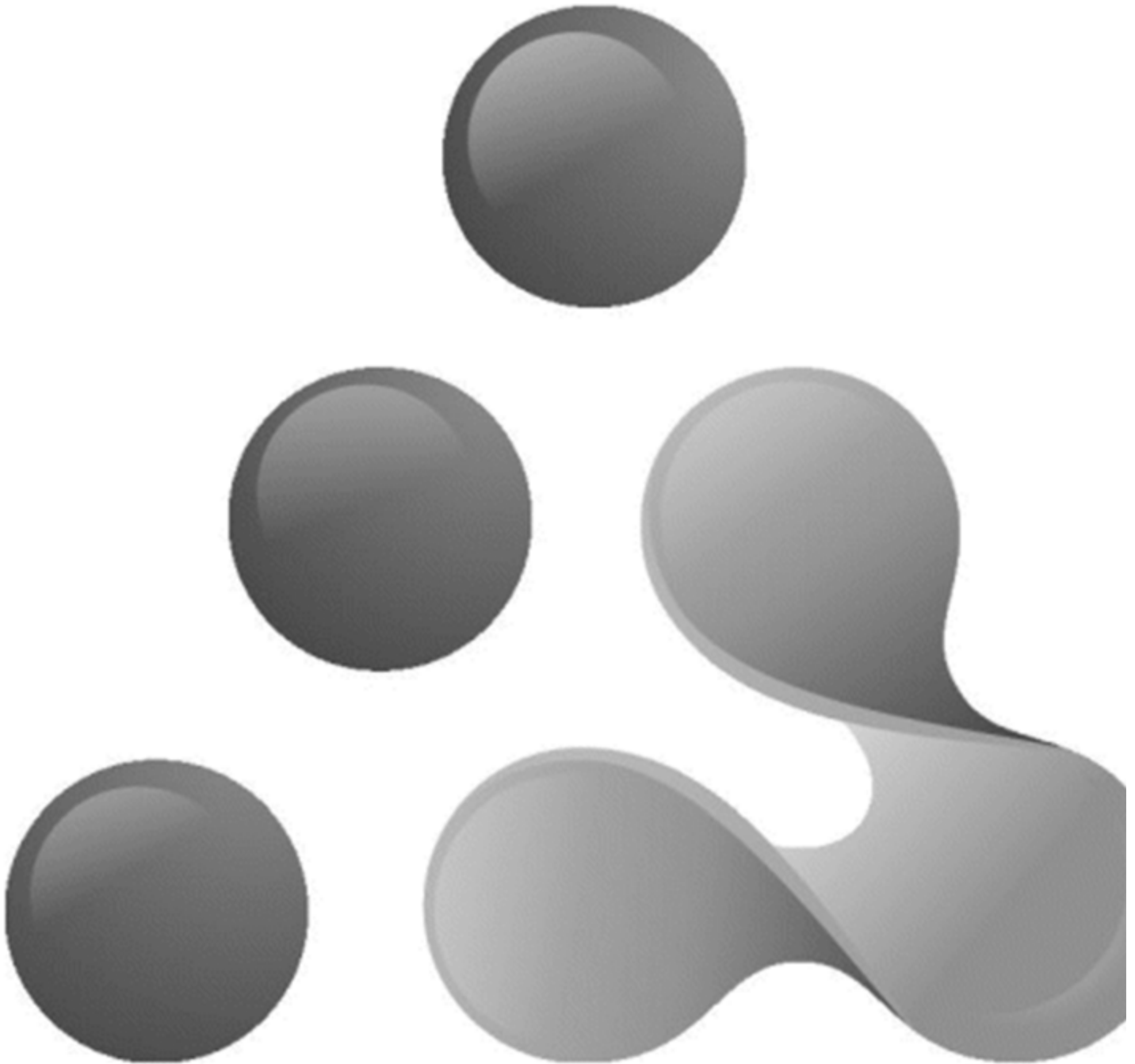
**Goods****Class 01**

(1) Water purifying chemicals; water treatment preparations (chemical); chemicals for treating water; chemicals for use in purifying water; chemicals for use in the purification of water; chemicals for the purification of water; chemical preparations for use in water purification; chemical preparations for the treatment of water; chemical preparations for use in water treatment; chemicals for use in clarifying water; chemicals for use in cleaning water; chemicals for use in clearing water; chemical additives for use in the cleaning of water; filter aids for liquid purification, namely, solvents for use in water purification.

**Class 11**

(2) Water filters for industrial purposes; filters for drinking water; filters for water purifiers; domestic water filtering units; drinking water filters; industrial waste water purification plants; municipal water purification machines; sterilizers for water treatment; tap-water purifying apparatus; water distillation units; water filtering units for domestic use; water filtering units for industrial use; water purification machines for domestic use; water purifiers for household purposes; water purifiers for industrial purposes; water treatment plant filters; purification installations for sewage; rainwater purification installations; water conditioning units; water distillation units.

**Services****Class 40**

Treatment of chemical waste; chemical treatment of waste products; chemical recycling of waste products; demineralization of water; water purification; water treating; treatment of waste water; waste water treatment; water treatment; industrial treatment of effluents; rental of water treatment equipment; waste water reprocessing; waste water treatment services; water and sewer management; water recycling; water treating.

**Application Number** 1,937,086  
**Language of Application** English

**Filing Date** 2018-12-19

## APPLICANT AND AGENT DETAILS

### Applicant

Analgesic Solutions LLC  
321 Commonwealth Road, Suite 204  
Wayland, MA 01778  
UNITED STATES OF AMERICA

### Agent

GOWLING WLG (CANADA) LLP  
SUITE 2600, 160 ELGIN STREET, OTTAWA,  
ONTARIO, K1P1C3

## TRADEMARK DETAILS

### Trademark Type

Design

### Visual Representation



### Colour Claim

Colour is claimed as a feature of the trademark. The mark consists of a drawing of a butterfly, the right wing of the butterfly is in blue, and the left wing and the body of the butterfly are in dark blue.

### Services

#### Class 41

(1) Training services in the field of clinical trials

#### Class 42

(2) Providing scientific research information in the field of clinical trials in the nature of evaluation and monitoring, namely, assisting, and facilitating clinical trial procedures for others

### Claims

Priority Filing Date: June 20, 2018, Country or Office: UNITED STATES OF AMERICA, Application No: 88/007523 in association with the same kind of services (1)



**Application Number** 1,937,911  
**Language of Application** English

**Filing Date** 2018-12-21

## APPLICANT AND AGENT DETAILS

### Applicant

Digistore24 Inc.  
360 Central Avenue  
Suite 800  
St. Petersburg, FL 33701  
UNITED STATES OF AMERICA

### Agent

PARLEE MCLAWS LLP  
1700 Enbridge Centre, 10175-101 Street NW,  
EDMONTON, ALBERTA, T5J0H3

## TRADEMARK DETAILS

# DIGISTORE

### Trademark Type

Standard Characters

### Services

#### Class 35

(1) Value-added online reseller of products and services, namely, providing online marketplaces for the advertising and sales of products and services for others; operating on-line marketplaces for sellers and buyers of goods and/or services; on-line retail store services featuring software, downloadable digital videos, images, and documents, tickets for educational events, training and educational videos, books, electronic books; value-added online provider of business management and automation services for others, namely, the administration and automation of computerized order taking, invoicing, accounting, distribution, shipping, delivery, monitoring, marketing, memberships, payment processing, and reporting for others; affiliate marketing, namely, referring internet traffic to websites of affiliates; advertising and marketing services, namely, promoting the goods and services of others via a global computer network; marketing services in the nature of promotion of third-party goods and services by brand ambassadors

#### Class 42

(2) Providing internet search engines for product manufacturers, service purveyors, and for retail customers of goods and services; providing online non-downloadable software for uploading videos, digital images, and documents to marketplaces and managing and remotely accessing information stored in databases and data warehouses, telecommunication networks, and computer networks; integration of computer systems and networks; computer systems integration services; providing a search engine for users of an online marketplace for buyers and sellers of goods and services

### Claims

Priority Filing Date: June 26, 2018, Country or Office: UNITED STATES OF AMERICA, Application No: 88/015,878 in association with the same kind of services (2); June 26, 2018, Country or Office: UNITED STATES OF AMERICA, Application No: 88/015,870 in association with the same kind of services (1)

**Application Number** 1,937,917  
**Language of Application** English

**Filing Date** 2018-12-21

## APPLICANT AND AGENT DETAILS

### Applicant

Digistore24 Inc.  
360 Central Avenue  
Suite 800  
St. Petersburg, FL 33701  
UNITED STATES OF AMERICA

### Agent

PARLEE MCLAWS LLP  
1700 Enbridge Centre, 10175-101 Street NW,  
EDMONTON, ALBERTA, T5J0H3

## TRADEMARK DETAILS

### Trademark Type

Design

### Visual Representation

# DIGISTORE24

### Services

#### Class 35

(1) Value-added online reseller of products and services, namely, providing online marketplaces for the advertising and sales of products and services for others; operating on-line marketplaces for sellers and buyers of goods and/or services; on-line retail store services featuring software, downloadable digital videos, images, and documents, tickets for educational events, training and educational videos, books, electronic books; value-added online provider of business management and automation services for others, namely, the administration and automation of computerized order taking, invoicing, accounting, distribution, shipping, delivery, monitoring, marketing, memberships, payment processing, and reporting for others; affiliate marketing, namely, referring internet traffic to websites of affiliates; advertising and marketing services, namely, promoting the goods and services of others via a global computer network; marketing services in the nature of promotion of third-party goods and services by brand ambassadors; providing online marketplaces and business services for others, namely, providing searchable databases, and search engines for online marketplaces for buyers and sellers of goods and services

#### Class 42

(2) Providing internet search engines for product manufacturers, service purveyors, and for retail customers of goods and services; providing online non-downloadable software for uploading videos, digital images, and documents to marketplaces and managing and remotely accessing information stored in databases and data warehouses, telecommunication networks, and computer networks; integration of computer systems and networks; computer systems integration services

### Claims

Priority Filing Date: June 26, 2018, Country or Office: UNITED STATES OF AMERICA, Application No: 88/015,906 in association with the same kind of services (2); June 26, 2018, Country or Office: UNITED STATES OF AMERICA, Application No: 88/015,894 in association with the same kind of services (1)

**Application Number** 1,939,057  
**Language of Application** English

**Filing Date** 2019-01-04

## APPLICANT AND AGENT DETAILS

### Applicant

Red Seat Ventures, LLC  
129 W 29th St.  
New York, NY 10001  
UNITED STATES OF AMERICA

### Agent

RIDOUT & MAYBEE LLP  
250 University Avenue, 5th Floor, Toronto,  
ONTARIO, M5H3E5

## TRADEMARK DETAILS

# CRIMECON

### Trademark Type

Standard Characters

### Services

#### Class 41

entertainment services, namely, producing podcasts in the crime genre

**Application Number** 1,939,163  
**Language of Application** English

**Filing Date** 2019-01-04

## APPLICANT AND AGENT DETAILS

### Applicant

DYE & DURHAM CORPORATION  
199 Bay Street  
Commerce Court West, Suite 4610  
Toronto  
ONTARIO  
M5L1E9

### Agent

DLA PIPER (CANADA) LLP  
1 FIRST CANADIAN PLACE, SUITE 6000, P.  
O. BOX 367, 100 KING STREET WEST,  
TORONTO, ONTARIO, M5X1E2

## TRADEMARK DETAILS

# ECHEQUEOUT

### Trademark Type

Word

### Goods

#### Class 09

Computer and cellular telephone software for transferring money between users and between banks and users

### Services

#### Class 36

Electronic money transfer services

**Application Number** 1,939,639  
**Language of Application** English

**Filing Date** 2019-01-08

## APPLICANT AND AGENT DETAILS

### Applicant

Pariveda Solutions, Inc., a legal entity  
2811 McKinney Ave., Suite 220  
Dallas, TX 75204  
UNITED STATES OF AMERICA

### Agent

RICHES, MCKENZIE & HERBERT LLP  
SUITE 1800, 2 BLOOR STREET EAST,  
TORONTO, ONTARIO, M4W3J5

## TRADEMARK DETAILS

### Trademark Type

Design

### Visual Representation

LEARN.COACH.GIVE

## Services

### Class 35

(1) business consulting services, namely, in the field of optimization of human capital and computing technology; business consulting services, namely, evaluation and implementation of corporate strategies, human capital, computer infrastructure, computing technical assets, and processes; business consultation services in the field of information technology, namely, evaluation and implementation of strategies and processes to efficiently implement human capital and computing technology; business consultation services, namely evaluation and optimization of business computer applications

### Class 42

(2) Consultation services, namely, in the field of software selection methodologies, software requirement definition, software application implementation and integration services; computer consultation services in the field of software and hardware information technology

## Claims

Priority Filing Date: December 19, 2018, Country or Office: UNITED STATES OF AMERICA, Application No: 88/235,217 in association with the same kind of services

**Application Number** 1,939,650  
**Language of Application** English

**Filing Date** 2019-01-08

## APPLICANT AND AGENT DETAILS

### Applicant

Flow Scientific Ltd.  
1130-400 Burrard St  
Vancouver  
BRITISH COLUMBIA  
V6C3A6

### Agent

NATHALY J. VERMETTE  
(DS AVOCATS), 1080 Côte du Beaver Hall,  
Bureau 2100, Montréal, QUEBEC, H2Z1S8

## TRADEMARK DETAILS

# FLOW SCI

### Trademark Type

Word

### Goods

#### Class 03

- (1) Fruit flavourings being essential oils and Terpenes.
- (3) Diluents, namely cannabis and marijuana oil thinners.

#### Class 34

- (2) Vaping pens for smoking purposes; Vaping pen kits containing vaping pens for smoking purposes and vaping pen cases; Cigarettes cases.

### Services

#### Class 35

- (1) Retail sale of terpenes in the field of cannabis and marijuana.
- (2) Retail sale of fruit flavourings in the field of cannabis and marijuana.
- (3) Retail sale of diluents in the field of cannabis and marijuana.
- (4) Retail sale of vaporizer pens and kits in the field of cannabis and marijuana.

**Application Number** 1,939,999  
**Language of Application** English

**Filing Date** 2019-01-10

## APPLICANT AND AGENT DETAILS

### Applicant

Home Depot International, Inc.  
2455 Paces Ferry Road, NW  
Atlanta, GA 30339  
UNITED STATES OF AMERICA

### Agent

BERESKIN & PARR LLP/S.E.N.C.R.L., S.R.L.  
SCOTIA PLAZA, 40 KING STREET WEST,  
40th FLOOR, TORONTO, ONTARIO, M5H3Y2

## TRADEMARK DETAILS

# HUSKY

### Trademark Type

Word

### Authorisation For Use

Consent from Saint Mary's University is of record.

### Goods

#### Class 06

(1) Drywall repair clips

#### Class 08

(2) Drywall circle cutters, drywall corner tool, drywall inside corner tool, drywall hawk, drywall rasp, drywall roll lifter, drywall taper, drywall utility saw; hand tool for scooping, hand-operated bucket scooping tool; metal hand-held mixer; mud pan; multi-purpose tool for use as a can opener, spreader and nail puller; on-gun air-pressure and flow control adjustment valve; hand sander, dust free hand sander, pole sander, pole sander head, plastic hand sander; saws, drywall texture brush, texture sprayer namely hand-pumped sprayer for drywall, hopper gun; knock down knife, joint knife, taping knives

#### Class 09

(3) T-squares for measuring

#### Class 19

(4) Drywall repair patch



**Application Number** 1,940,546  
**Language of Application** English

**Filing Date** 2019-01-14

## APPLICANT AND AGENT DETAILS

### Applicant

EMPRISE CANADA INC.  
Suite 2820, 150-9 Avenue SW  
Calgary  
ALBERTA  
T2P3H9

### Agent

FLANSBERRY, MENARD & ASSOCIATES  
/ASSOCIÉS  
105-2283 St Laurent BLVD, OTTAWA,  
ONTARIO, K1G5A2

## TRADEMARK DETAILS

# Advanced Nano

### Trademark Type

Word

### Goods

#### Class 01

(1) proteins for use in the manufacture of food supplements

#### Class 03

(2) cannabis oil for cosmetic purposes; lavender water

#### Class 05

(3) dietary supplements for general health and well-being; dietary supplements for promoting weight loss; flaxseed oil dietary supplements; herbal and dietary supplements for promoting faster muscle recovery after exercise; herbal supplements for general health and well-being; herbal supplements for the treatment of arthritis; herbal supplements for the treatment of cancer; herbal supplements for the treatment of headaches; herbal supplements for use in dermatology, namely, dermatitis, eczema, psoriasis; medicinal cannabis for temporary relief of seizures; medicinal cannabis for the relief of nausea caused by chemotherapy; medicinal cannabis for the relief of nerve pain; medicinal cannabis for the treatment of muscle spasms caused by multiple sclerosis; mineral nutritional supplements; mineral supplements; nutritional supplements for general health and well-being; protein supplements for animals; vitamin and mineral dietary supplements; vitamin and mineral food supplements; vitamin and mineral supplements; vitamin and mineral supplements for pets; vitamin enriched water for medical use; vitamin supplement patches; vitamin supplements; vitamin supplements for animals; zinc supplement lozenges

#### Class 29

(4) cannabis oil for food

#### Class 30

(5) chocolate bars infused with cannabis

#### Class 32

(6) aerated mineral waters; aerated water; bottled drinking water; bottled water; carbonated mineral water; carbonated mineral waters; carbonated water; carbonated waters; coconut water; coconut water beverages; flat water; flavoured mineral water; flavoured mineral waters; flavoured

waters; glacial water; mineral and carbonated waters; mineral enhanced water; mineral water; protein-enriched sports beverages; soda water; sparkling mineral water; sparkling water; spring water; still water; tonic water; vitamin enhanced water

**Application Number** 1,940,578  
**Language of Application** English

**Filing Date** 2019-01-14

## APPLICANT AND AGENT DETAILS

### Applicant

Target Brands, Inc.  
1000 Nicollet Mall  
Minneapolis, MN 55403  
UNITED STATES OF AMERICA

### Agent

BERESKIN & PARR LLP/S.E.N.C.R.L., S.R.L.  
SCOTIA PLAZA, 40 KING STREET WEST,  
40th FLOOR, TORONTO, ONTARIO, M5H3Y2

## TRADEMARK DETAILS

# EVERSPRING

### Trademark Type

Word

### Goods

#### Class 03

(1) Household cleaning preparations namely all-purpose cleaning preparations; laundry detergent; laundry bleach; fabric softeners and conditioners for laundry use; all-purpose drain openers; automatic and liquid dishwashing detergents; disposable wipes impregnated with chemicals or compounds for household use; air fragrance preparations; disposable wipes impregnated with personal cleansing preparations for personal hygiene; hair care preparations, namely, shampoo, conditioner, hair spray; cotton swabs, sticks, balls, and puffs for personal cosmetic use; petroleum jelly for cosmetic purposes; non-medicated sun care preparations; nail care preparations; bar soap; non-medicated liquid soap; hand lotion; liquid body wash; after shave and shaving preparations; deodorants and antiperspirants; non-medicated mouthwash; toothpaste; air fragrance preparations for household and auto use; all purposes cleaners; ammonia for cleaning purposes; essential and scented oils for aromatherapy; air fragrance reed diffusers and air diffusers for adding fragrance to a room; anti-static dryer sheets; fabric stain remover sticks

#### Class 04

(2) Candles

#### Class 05

(3) Medicated liquid soap namely antibacterial skin soaps; hand-sanitizing preparations; alcohol for medicinal purposes namely rubbing alcohol; cotton swabs for medical use, alcohol-prepared pads for sanitizing use, adhesive bandages; air deodorizing preparations; all-purpose disinfectants; pain relief medications; multivitamin preparations; antibiotic creams and ointments; calamine lotion; epsom salts; gauze compresses, gauze for dressings, gauze for medical purposes; hydrogen peroxide for medical use; medical adhesive tape; feminine hygiene pads; tampons for personal use, sanitary tampons; petroleum jelly for medical purposes used for treating chapped lips; insect repellents; first aid kits; corn and callus pads; laundry sanitizer tablets; air freshening preparations in the nature of sprays namely air deodorizer sprays

#### Class 06

(4) Aluminum foil

**Class 08**

(5) Razors and razor blades, corn and callus rasps; manicure and pedicure implements, namely, nail files, nail clippers, nail buffers, cuticle pushers, tweezers, nail and cuticle scissors; scissors; disposable tableware, namely, forks, knives and spoons; emery boards

**Class 11**

(6) Heating and cooling packs filled with chemical substances that react when required to warm or cool the body, not for medical purposes; electric dispensers for air fresheners; drinking water filters

**Class 16**

(7) Paper napkins, paper place mats; facial tissue; bathroom tissue; paper lunch bags; paper towels; plastic bags, namely, trash and garbage bags, sandwich bags, food storage and freezer bags for household use; general purpose plastic and paper bags; plastic wrap; disposable lawn and leaf bags; paper; notepads; adhesive tape for household use; envelopes; paper-clips; folders namely stationery folders, file folders, document file folders, hanging folders, folders for papers; binders, namely, loose-leaf binders, stationery binders, office supply binders; notebooks; stationery, namely paper, labels, seals, stickers, envelopes, rulers, erasers, pencil sharpeners, pencil cases; writing instruments; binder clips; rubber bands

**Class 21**

(8) Disposable tableware, namely, plates, cups, bowls; toothbrushes; body sponges; disposable latex gloves for general use; premoistened towelettes for household cleaning; food storage containers for household use; toothpicks; household cleaning brushes and sponges; clothes brushes; paper baking cups; waste baskets; laundry baskets; drinking straws; lunch bags not of paper; dryer balls; soap dispensers; dental floss; dental floss dispensers; dental floss picks; dental care kit comprising toothbrushes and floss; hair brushes; hair combs; mops; brooms; dusters; cleaning cloths; plug-in diffusers for air fragrance; electric dispensers of insect repellents to be plugged into wall outlets

**Services****Class 35**

Retail department store services and online retail department store services

**Claims**

Priority Filing Date: July 15, 2018, Country or Office: UNITED STATES OF AMERICA, Application No: 88038432 in association with the same kind of goods (2), (4), (7) and in association with the same kind of services; July 16, 2018, Country or Office: UNITED STATES OF AMERICA, Application No: 88039567 in association with the same kind of goods (1), (3), (5), (6), (8)

**Application Number** 1,940,924  
**Language of Application** English

**Filing Date** 2019-01-15

## **APPLICANT DETAILS**

**Applicant**  
DARIAN PETRISCA  
217 Gatwick Dr  
Oakville  
ONTARIO  
L6H6T6

## **TRADEMARK DETAILS**

**Trademark Type**  
Design

**Visual Representation**



**Goods**

**Class 01**

(1) Water test kits

**Class 16**

(2) Stickers and decals

**Services****Class 42**

(1) Testing of water to determine potability and to identify the presence of contaminants and microbes; Consulting services in the field of water quality testing

**Class 45**

(2) Advice and consultancy on environmental regulatory matters and on workplace safety, namely, ensuring that a business's water quality obligations have been met in order to prevent harm to employees, clients and customers, and to minimize liability risks related thereto

**Application Number** 1,941,956  
**Language of Application** English

**Filing Date** 2019-01-22

## APPLICANT AND AGENT DETAILS

### Applicant

Mobile Seasons GmbH  
Messedamm 22  
D-14055 Berlin  
GERMANY

### Agent

DAVIES WARD PHILLIPS & VINEBERG LLP  
ATTN: TRADE-MARK DEPARTMENT, 1501  
MCGILL COLLEGE AVENUE, 26TH FLOOR,  
MONTREAL, QUEBEC, H3A3N9

## TRADEMARK DETAILS

# DROIDCON

### Trademark Type

Word

### Services

#### Class 35

(1) Employment agencies; Advertising copywriting; Consultancy and advisory services relating to personnel placement; Providing recruitment information via a global computer network; Personnel recruitment agency services; Conducting exhibitions for business purposes; Developing promotional campaigns for business; Business merchandising display services; Window display services; Publication of publicity texts; Job placement services; Career networking services; Market research; Market analysis; Marketing studies; Arranging and conducting of trade shows, trade fairs, exhibitions in the field of software development tools and developer services, employer branding and employee recruiting; Promoting the goods and services of others through advertisements on Internet websites; Outsourcing services in the nature of arranging service contracts for others; Commercial lobbying services; Sales demonstration for others; Rental of advertising space; Advertising agency services; Online advertising for others via a computer communications network; Provision of advertising space; Provision of advertising space on electronic media; Compilation of statistics; Administration of sales promotion incentive programs; consultancy relating to sales promotions; Providing and rental of exhibition stands and booths

#### Class 36

(2) rental of space in food halls for sellers of goods and services;

#### Class 41

(3) Organization of exhibitions, congresses, conferences symposia, seminars, workshops for entertainment, cultural, educational and training purposes in the fields of software development tools and developer services, employer branding and employee recruiting; Arranging of conventions for business purposes; Arranging and conducting competitions in the fields of software development, software coding, hackathons

#### Class 43

(4) providing convention hall facilities; rental of conference rooms;

#### Class 45

(5) Consultancy relating to trademark licensing



**Application Number** 1,943,039  
**Language of Application** English

**Filing Date** 2019-01-28

## APPLICANT AND AGENT DETAILS

### Applicant

Afyx Therapeutics A/S  
Lergravsvej 57, 2. tv  
København S, 2300  
DENMARK

### Agent

SMART & BIGGAR LP  
1100-150 York street, TORONTO, ONTARIO,  
M5H3S5

## TRADEMARK DETAILS

# AFYX THERAPEUTICS

### Trademark Type

Word

### Goods

#### Class 05

Pharmaceuticals for treatment of mucosal diseases; pharmaceutical preparations and substances for treatment of mucosal diseases; pharmaceutical preparations for treating skin disorders, namely, bacterial skin infections, fungal skin infections; pharmaceutical preparations for treating mucous membrane disorders; pharmaceutical preparations, namely muco adhesive patches for efficient and uniform drug release for the treatment of mucous membrane disorders; medicine for treatment of mucosal diseases; medical preparations and articles, namely mucous membrane- and skin- adhesive patches for coverage of lesions and efficient and uniform drug delivery; patches for treatment of mucosal diseases; adhesive patches for medical purposes, namely for treatment of mucosal diseases; skin patches for the transdermal delivery of pharmaceuticals for use in the treatment of mucosal diseases; mucous membrane patches for the transdermal delivery of pharmaceuticals for use in the treatment of mucosal diseases; transdermal patches for use in the treatment of mucosal diseases; transdermal patches for medical treatment for use in the treatment of mucosal diseases; transmucosal patches for medical treatment of mucosal diseases; dressings, medical; adhesive dressings; dressings for wounds; bandages, medical, namely, bandages for dressings; adhesive bandages; bandages for skin wounds; bandages for mucous membrane wounds; mucosal surface delivery of pharmaceuticals for use in the treatment of mucosal diseases

### Services

#### Class 42

(1) Scientific, medical and pharmaceutical research and development services; research and development of pharmaceutical preparations; research and development of pharmaceutical preparations for treating skin disorders; research and development of pharmaceutical preparations for treating mucous membrane disorders; research and development of pharmaceutical preparations, namely muco adhesive patches for efficient and uniform drug release; research and development of medicines; research and development of medical preparations and articles, namely mucous membrane- and skin- adhesive patches for coverage of lesions and efficient and uniform drug delivery; medical research and analysis services; biological research; clinical

research in the field of treatment of mucosal diseases; scientific investigations for medical purposes in the field of pharmacovigilance; scientific laboratory services; medical research laboratory services; laboratory research services relating to pharmaceuticals

**Class 44**

(2) Medical services; medical treatment services; medical screening; medical monitoring, testing, inspection and analysis services; medical services relating to the diagnosis and treatment of skin disorders; medical services relating to the diagnosis and treatment of mucous membrane disorders; pharmaceutical services; pharmaceutical advisory services; dermatological services for treating skin conditions; dermatological services for treating mucous membrane conditions; laboratory analysis services relating to the diagnosis and treatment of skin disorders; laboratory analysis services relating to the diagnosis and treatment of mucous membrane disorders

**Claims**

Priority Filing Date: August 10, 2018, Country or Office: EUIPO (EU), Application No: 017941511 in association with the same kind of goods and in association with the same kind of services

**Application Number** 1,943,199  
**Language of Application** English

**Filing Date** 2019-01-29

## APPLICANT AND AGENT DETAILS

### Applicant

Treasury Wine Estates (Matua) Limited  
351 Jacksons Road  
RD3, Rapaura  
Blenheim 7273  
NEW ZEALAND

### Agent

GOWLING WLG (CANADA) LLP  
SUITE 2600, 160 ELGIN STREET, OTTAWA,  
ONTARIO, K1P1C3

## TRADEMARK DETAILS

# SQUEALING PIG

### Trademark Type

Word

### Goods

#### Class 32

(1) Beer, ale, porter; non-alcoholic beverages, namely, non-alcoholic beers, alcohol-free wine; de-alcoholised wines; Alcohol-free fruit beverages; Fruit juices; Grape juice; Non-alcoholic fruit extracts; Non-alcoholic preparations for making beverages, namely concentrates for making fruit beverages; non-alcoholic wines; grape juice; citrus juices; non-alcoholic beverages, particularly those of grape origin, namely grape-based non-alcoholic beverages and preparations for making same

#### Class 33

(2) Wine; alcoholic beverages (except beers), namely, fortified wines, sparkling wines, alcoholic coolers, vodka, whisky, bourbon, tequila, calvados, scotch, rye whiskey, cognac, gin, rum, brandy, liqueurs

### Claims

Priority Filing Date: August 01, 2018, Country or Office: AUSTRALIA, Application No: 1945131 in association with the same kind of goods

**Application Number** 1,943,695  
**Language of Application** English

**Filing Date** 2019-01-31

## APPLICANT AND AGENT DETAILS

### Applicant

WapSync Inc.  
11, rue des Tilleuls  
Fossambault-sur-le-Lac  
QUEBEC  
G3N1Y7

### Agent

NORTON ROSE FULBRIGHT CANADA LLP/S.  
E.N.C.R.L.,S.R.L.  
COMPLEXE JULES-DALLAIRE/TOUR  
OGILVY RENAULT , BUREAU 1500, 2828,  
BOULEVARD LAURIER, QUÉBEC, QUEBEC,  
G1V0B9

## TRADEMARK DETAILS

# WAPSYNC

### Trademark Type

Word

### Goods

#### Class 09

Computer hardware, computer software and computer firmware for the management, display and analysis of radar data, traffic lights, traffic control lights; traffic control management equipment, namely, display monitors, computers, radar sensors, acceleration sensors, distance sensors, velocity sensors, motion sensors, proximity sensors, optical sensors, radar detectors; intelligent traffic and transportation monitoring and information systems comprising software and devices for monitoring and controlling traffic and traffic signals, namely display monitors, computers, automatic directional compasses, and software to manage traffic, radar detectors.

### Services

#### Class 42

Computer services, namely, design, programming, maintenance and development of computer systems for traffic control management.

**Application Number** 1,943,961  
**Language of Application** English

**Filing Date** 2019-02-01

## APPLICANT AND AGENT DETAILS

### Applicant

MNKL STHLM AB  
Fogdevägen 66  
12841  
Stockholm  
SWEDEN

### Agent

OSLER, HOSKIN & HARCOURT LLP  
SUITE 6200, P.O. BOX 50, 1 FIRST  
CANADIAN PLACE, TORONTO, ONTARIO,  
M5X1B8

## TRADEMARK DETAILS

# MONOKEL EYEWEAR

### Trademark Type

Word

### Foreign Character Translation

The translation provided by the applicant of the Swedish word MONOKEL is monocle.

### Goods

#### Class 09

(1) Spectacles; Spectacle frames; Spectacle chains; Spectacle cases; Spectacle straps; Eyewear cases; Eyeglass shields; Spectacle temples; Eyeglass lanyards; Polarizing spectacles; Antireflection coated eyeglasses; Unmounted spectacle frames; Bars for spectacles, namely replacement arms for spectacles; Protective covers for eyeglasses; Prescription eyewear; Side guards for eyeglasses; Glasses, sunglasses and contact lenses; Frames for spectacles and sunglasses; Chains for spectacles and for sunglasses; Cases for spectacles and sunglasses; Spectacle frames made of metal and of synthetic material; Spectacle frames made of a combination of metal and plastics; Spectacle frames made of metal or of a combination of metal and plastic; Cases for sunglasses; Prescription sunglasses; Straps for sunglasses; Clip-on sunglasses; Lenses for sunglasses; Frames for sunglasses; Cords for sunglasses; Protective covers for sunglasses; Sunglass nose pads; Sunglass temples; Sunglass cords; Chains for sunglasses; Optical lenses for use with sunglasses

(2) Sunglasses; Cases for sunglasses; Prescription sunglasses

**Application Number** 1,943,982  
**Language of Application** English

**Filing Date** 2019-02-01

## APPLICANT AND AGENT DETAILS

### Applicant

AESTHETICS BIOMEDICAL, INC.  
4602 N. 16th Street, Suite 300  
Phoenix, AZ 85004  
UNITED STATES OF AMERICA

### Agent

MARKS & CLERK  
33 Yonge Street, , Suite 300, Toronto,  
ONTARIO, M5E1G4

## TRADEMARK DETAILS

# SANAA

### Trademark Type

Standard Characters

### Services

#### Class 44

Providing personalized beauty spa services, namely, cosmetic body care and microneedle services

### Claims

Priority Filing Date: August 03, 2018, Country or Office: UNITED STATES OF AMERICA,  
Application No: 88/065,166 in association with the same kind of services

**Application Number** 1,944,160  
**Language of Application** English

**Filing Date** 2019-02-01

## APPLICANT AND AGENT DETAILS

### Applicant

CB Brand Strategies, LLC acting through CB  
Brand Strategies, LLC, Wilmington, Delaware,  
USA, Zug Branch  
Baarerstrasse 10  
Zug 6300  
SWITZERLAND

### Agent

BORDEN LADNER GERVAIS LLP  
Bay Adelaide Centre, East Tower, 22 Adelaide  
St. West, TORONTO, ONTARIO, M5H4E3

## TRADEMARK DETAILS

# SEAWORTHY

### Trademark Type

Standard Characters

### Goods

#### Class 32

(1) Beer; flavored beer

#### Class 33

(2) Alcoholic beverages except beer, namely, flavoured alcoholic malt-based beverages consisting of coffee infused with nitrogen; flavored alcoholic malt-based cocktails

### Claims

Priority Filing Date: August 16, 2018, Country or Office: UNITED STATES OF AMERICA,  
Application No: 88/081,553 in association with the same kind of goods

**Application Number** 1,944,469  
**Language of Application** English

**Filing Date** 2019-02-05

## APPLICANT AND AGENT DETAILS

### Applicant

Ashworth and Parker Limited  
Unit C Merlin Way  
New York Industrial Park  
Newcastle upon Tyne NE27 0QC  
UNITED KINGDOM

### Agent

BERESKIN & PARR LLP/S.E.N.C.R.L., S.R.L.  
SCOTIA PLAZA, 40 KING STREET WEST,  
40th FLOOR, TORONTO, ONTARIO, M5H3Y2

## TRADEMARK DETAILS

# END

### Trademark Type

Word

### Goods

#### Class 25

ankle boots; beanies; blazers; boat shoes; bomber jackets; boots; boxer shorts; bucket hats; caps; cardigans; cargo pants; casual clothing; casual pants; casual shoes; coats; denim jackets; desert boots; down jackets; dress shoes; dressing gowns; dungarees; fleece tops; hats; headbands; hiking boots; hoodies; jackets; jeans; knitted tops; lace boots; leather jackets; leather shoes; loafers; long jackets; long sleeve shirts; lounge pants; lounging pyjamas; outerwear jackets; padded jackets; parkas; sandals; slippers; sneakers; toques; visors being headwear



**Application Number** 1,944,474  
**Language of Application** English

**Filing Date** 2019-02-05

## APPLICANT AND AGENT DETAILS

### Applicant

Jennifer Hendrix  
639 Brenna Rd  
Waxahachie, TX 75165  
UNITED STATES OF AMERICA

### Agent

MILTONS IP/P.I.  
#200-15 Fitzgerald Road, Ottawa, ONTARIO,  
K2H9G1

## TRADEMARK DETAILS

# CHANGING I WISH TO I CAN

### Trademark Type

Word

### Goods

#### Class 09

Computer application software for mobile phones, namely, software for providing instructions for navigating through buildings; electronic devices being wireless location finders enabled with software for global position navigation systems for locating and tracking the location of a user within a building to provide route guidance; global positioning system (GPS) consisting of computers, computer software, transmitters, receivers, and network interface devices; satellite navigation devices; satellite navigation systems; global positioning system (GPS) satellites

**Application Number** 1,944,527  
**Language of Application** English

**Filing Date** 2019-02-05

## APPLICANT AND AGENT DETAILS

### Applicant

The Los Angeles Kings Hockey Club, L.P.  
1111 So. Figueroa Street  
Los Angeles, CA 90015  
UNITED STATES OF AMERICA

### Agent

BERESKIN & PARR LLP/S.E.N.C.R.L., S.R.L.  
SCOTIA PLAZA, 40 KING STREET WEST,  
40th FLOOR, TORONTO, ONTARIO, M5H3Y2

## TRADEMARK DETAILS

# L.A. KINGS

### Trademark Type

Standard Characters

### Goods

#### Class 06

(1) goods of non-precious metals, namely, metal license plates, door knockers, metal road signs, trophies made of common metal, weather vanes

#### Class 09

(2) audio and video electronics, namely, electronic notebooks, electronic tablets, personal digital assistants, smart phones, cases and covers for personal digital assistants, electronic tablets and notebooks; stands for personal digital electronic devices, namely, personal digital assistants, cell phones, and MP3 players; cell phone chargers, cell phone face plates, ear phones, blank USB flash drives, blank DVDs, computer mouse and mouse pads, pre-recorded DVDs containing computer games in the field of the game of hockey; prerecorded videotapes, audio tape recordings, DVDs containing movies, documentaries, and films in the field of the game of hockey; downloadable electronic audio and video publications, relating to the game of hockey, namely magazines, books, multimedia news podcasts and multimedia news webcasts, video and computer games; video game cartridges and discs; binoculars; decorative switch plate covers; eyewear, namely sports eyewear, eyeglasses, sunglasses; eyeglass chains and cords; decorative magnets; tape measures, docking stations for mobile phones and MP3 players, hand-held computer; protective helmets for sports, protective visors for athletic use, neon signs

#### Class 11

(3) electric night lights, electric lamps, lampshades, refrigerators, electronic toasters, barbecue grill covers

#### Class 12

(4) spare tire covers, license plate frames and license plate holders

#### Class 14

(5) Items made of precious and non-precious metals, namely, commemorative coins and medals, trophies and key chains made of precious metals, jewelry, jewelry charms, earrings, medallions, rings, necklaces, tie tacks, pins in the nature of jewelry, watches and clocks, cuff links, key chain fobs, lanyards for holding keys

**Class 16**

(6) Printed matter and publications, namely, address books, adhesive labels, appointment books, framed artwork, autograph books, business card holders, book covers, book marks, booklets, books, bumper stickers, calendars, check books, coloring books, commemorative game tickets, decals, diaries, envelopes, erasers, flags and pennants of paper, game and souvenir programs concerning hockey, gift tags, gift wrapping paper, greeting cards, lithographs, magazines, note pads, paintings, pamphlets, paper banners, paper napkins, paper towels, paperweights, pencil cases, pencil sharpeners, writing instruments, photograph albums, photographs (mounted and unmounted), postcards, posters, printed paper signs, printed awards and certificates, printed schedules, drawing rulers, scrap books, serigraphs, paper doorknob hanger signs, stickers, sticker packs and sticker albums, trading cards and trading card albums, writing pads and writing paper, money clips

**Class 18**

(7) soft luggage and bags, namely, all-purpose sports and sports equipment bags, back packs, duffel bags, knapsacks, waist packs, gym bags, garment bags for travel, satchels, tote bags, wallets, key cases, luggage tags, billfolds, umbrellas

**Class 20**

(8) chairs, decorative mirrors, display cases, mirrors, picture frames, pillows, novelty license plates made of plastic, stools, tables, wall plaques made of plastic or wood, billiard/pool cue racks

**Class 21**

(9) Bottle openers, bowls, candy jars, coffee mugs, cups and saucers, cutting boards, drink coasters, drinking cups, drinking flasks, drinking glasses, glass bowls, glass figurines, glass pitchers, kitchen utensils namely barbecue forks, barbecue spatulas and barbecue tongs; plates, salt and pepper shakers, garbage cans, water bottles, coin banks

**Class 22**

(10) lanyards for holding badges

**Class 24**

(11) fabric and textile products, namely, beach towels, billiard cloths, blankets, cloth banners, cloth flags, pennants made of textile, bed sheets, pillow cases

**Class 25**

(12) clothing, namely, bandanas, beach cover-ups, belts, body suits, boxer shorts, caps, cloth bibs, coats, dresses, ear muffs, gloves, hats, headbands, hosiery, housecoats, jackets, hockey jerseys, leggings, leotards, men's dress suits and casual suits, mittens, nightshirts, pajamas, pants, rainwear, raincoats, bath robes, beach robes, scarves, shirts, shorts, skirts, socks, sun visors, suspenders, sweaters, sweatpants, sweatshirts, swim trunks, swimsuits, ties, toques, t-shirts, underwear, vests, warm-up suits, wristbands; Shoes, boots, sandals, slippers and athletic shoes

**Class 26**

(13) hair accessories, ornamental novelty buttons, patches for clothing

**Class 27**

(14) carpets and carpet tiles, door mats, floor and vehicle mats, rugs, yoga mats

**Class 28**

(15) toys, games and sporting goods, namely, action figures, adhesive tape for hockey sticks, party balloons, play balloons, toy balloons, billiard/pool cue sticks, billiard/pool balls and triangles,

board games, bobble head dolls, cheerleading pom-poms, checker sets, chess sets, Christmas stockings, Christmas tree ornaments, darts and dart boards, dolls; elbow pads, shin pads, knee pads and protective gloves for athletic use; field, street, in-line and roller hockey balls; flying discs, goalie masks for hockey, golf bags, golf balls, head covers for golf clubs; hand-held home video game machine, hockey pucks, hockey sticks, ice skate blade covers, ice skate blade guards, ice skates, inline and conventional roller skates, inflatable toys, jigsaw and manipulative puzzles, kites, marbles, novelty golf balls, novelty miniature goalie masks and hockey sticks, plastic toy canteens, plush animals, puppets, stuffed figurines and animals, suction cup stuffed toy animals, scale model vehicles, table top rod hockey games, toy airplanes, toy cars, toy trucks, toy hockey games, return tops, playing cards; children's inflatable swimming pools, inflatable swimming floats for children

**Class 34**

(16) cigarette lighters not of precious and non-precious metal

**Services****Class 41**

entertainment services, namely arranging and conducting professional hockey exhibitions

**Application Number** 1,944,864  
**Language of Application** English

**Filing Date** 2019-02-06

## APPLICANT AND AGENT DETAILS

### Applicant

Kezar Life Sciences Australia Pty Ltd  
17 Praeger St  
CHAPEL HILL, QLD, 4069  
AUSTRALIA

### Agent

SMART & BIGGAR LP  
SUITE 900, 55 METCALFE STREET, P.O.  
BOX 2999, STATION D, OTTAWA, ONTARIO,  
K1P5Y6

## TRADEMARK DETAILS

# KEZAR

### Trademark Type

Word

### Goods

#### Class 01

(1) Active chemical ingredients for use in the manufacture of pharmaceuticals

#### Class 05

(2) Pharmaceuticals for the prevention and treatment of cancer; pharmaceuticals for the treatment of autoimmune diseases and disorders

### Services

#### Class 42

Medical research; biotechnology research; pharmaceutical research and development

### Claims

Priority Filing Date: August 06, 2018, Country or Office: AUSTRALIA, Application No: 1946216 in association with the same kind of goods and in association with the same kind of services

**Application Number** 1,945,764  
**Language of Application** English

**Filing Date** 2019-02-12

## APPLICANT AND AGENT DETAILS

### Applicant

Organika Health Products Inc.  
13480 Verdun Place  
Richmond  
BRITISH COLUMBIA  
V6V1V2

### Agent

COASTAL TRADEMARK SERVICES LIMITED  
301-543 Granville Street, Vancouver, BRITISH  
COLUMBIA, V6C1X8

## TRADEMARK DETAILS

# ORGANIKA ENHANCED COLLAGEN

### Trademark Type

Standard Characters

### Goods

#### Class 03

(1) skin care preparations; health and beauty aids, namely, facial and body cleansers, body lotions, skin conditioners, skin creams, skin lighteners, beauty masks, skin peels, skin toners, body scrubs and facial scrubs, bath gels, body gels, and shower gels, pore refiners, exfoliator, body mists, beauty serums, bath powder, bath talc, body moisturizers and facial moisturizers, shampoos, hair conditioners, shaving gels and foams, bronzers and sunscreens, cosmetics for the eyes, face, lips and nails;

#### Class 05

(2) dietary supplements to support joint health, joint care and flexibility, and to improve complexity of the skin; nutritional supplements in capsule, tablet, powder and liquid form used for healthy aging; nutraceuticals, namely anti-aging creams, sun block preparations, vitamins and minerals

**Application Number** 1,946,112  
**Language of Application** English

**Filing Date** 2019-02-13

## APPLICANT AND AGENT DETAILS

### Applicant

Creologic Design Inc.  
3400-10180 101 St NW  
Edmonton  
ALBERTA  
T5J3S4

### Agent

DAVID S. WELSH  
(c/o Ogilvie LLP ), 1400,10303 Jasper Ave. ,  
Edmonton, ALBERTA, T5J3N6

## TRADEMARK DETAILS

# WE SHOULD TALK

### Trademark Type

Word

### Goods

#### Class 09

computer software for use in creating and designing web sites

### Services

#### Class 35

(1) providing marketing consultancy in the field of social media; providing marketing consulting in the field of social media; social media strategy consulting; web indexing for commercial or advertising purposes

#### Class 42

(2) building and maintaining websites; consultancy in the field of webpage design; creating and designing web pages for others; creating and maintaining web sites for others; creating and maintaining weblogs for others; creating web pages for others; creation and maintenance of web sites for others; creation and provision of web pages to and for third parties; creation of internet web sites for others; creation, design, development and maintenance of web sites for third parties; design and creating web sites for others; design of homepages and websites; design, creation, hosting and maintenance of internet sites for third parties; design, creation, hosting, maintenance of websites for others; designing and creating web sites for others; website design; website design consultancy; website development for others

#### Class 45

(3) on-line social networking services

**Application Number** 1,946,232  
**Language of Application** English

**Filing Date** 2019-02-14

## APPLICANT AND AGENT DETAILS

### Applicant

PUK Group GmbH & Co. KG  
Nobelstraße 45-55  
12057 Berlin  
GERMANY

### Agent

MARKS & CLERK  
180 Kent Street, Suite 1900, Ottawa,  
ONTARIO, K1P0B6

## TRADEMARK DETAILS

# PohlCon

### Trademark Type

Word

### Goods

#### Class 06

(1) Metal building materials, namely, building boards of metal, building panels of metal, cladding of metal for building, expansion joints of metal for use in buildings, fittings of metal for building, flashing of metal for building, metal building flashing, metal pillars for building, metal trim for buildings, reinforcing materials of metal for building, tiles of metal for building; small items of metal hardware namely, bolts, nuts, screws, nails and springs; metal reinforcing materials for concrete, reinforcement rails, punching reinforcements, shear reinforcements, reinforcement anchors, double-head anchors, sandwich anchors, single shear pins; anchor rails, rail fastening rails and mounting rails, supports for such rails and parts to be suspended therefrom, namely, railing posts; trapezoidal sheet metal fastening rails; connecting elements for concrete component, punched-through reinforcements, reinforcement connectors, namely, metal reinforcement connector bars; metal facing brackets, mortar brackets; metal support legs and metal wall shoe pegs, stair support bearings, for setting in concrete for use in construction and building; metal screws, metal nuts, rivets, and metal studs, hammer-head screws, toothed screws, hook-head screws and nuts, sliding nuts, dowels, sleeve dowels, transport anchors, double shear pins, anchors, sandwich anchors, support anchors, retaining anchors, retaining brackets, torsion anchors, anchor bolts, transport anchor bolts and retaining wedges, retaining brackets; anchor sleeves and screw sleeves with anchors for embedding in concrete; metal cables, metal cable loops; earthing bridges for concrete reinforcements; sheet metal strips, sealing sheet metal strips with non-metallic coating, each for sealing concrete construction joints; shuttering of expanded metal for concrete; load connectors, in particular plug connectors, made of metal; shaped boxes made of metal for use in the building industry; cable support and cable laying systems and elements; cable trays, cable conduits, cable ladders, also of lattice material, wide-span cable trays, cable support trays, cable clamps, non-electrical cable connections, fastening straps, supports for cable trays; metal fastening material for cables and pipes; metal laying and fastening materials for telecommunications.

#### Class 09

(2) Cable distribution boxes and cable junction boxes; welding machines.

#### Class 17



(3) Goods made of plastic, namely, semi-finished product in the form of plastic foils, rods, profiles, hoses, tubes and blocks; sealing, packing and insulating material, namely, sealing rings, seals of metal for preventing leakage of fluids, seals of metal for preventing leakage of gases, non-metallic seals for preventing the leakage of gases, non-metallic seals for preventing leakage of fluids, rubber sheets for sealing purposes, sealing gaskets of metal, bonded seals, composite seals, dynamic seals, moulded foam for packing, lowdensity polyurethane foam for packing, packing foam in sheet form, plastic packing for shipping containers, extruded polystyrene pellets for packing, plastic pellets for packing, rubber packing for shipping containers, rubber sheets for packing purposes, foils of metal for insulating, electrical insulation, fiberglass for insulation, foam glass for use as an insulating material, glass fibre insulation, glass wool for insulation, insulating fabrics, insulating foam in the form of blocks, insulating foam for use in building and construction; swelling tapes for sealing concrete joints; thermal and/or acoustic insulation panels, in particular for concrete component joints; air hoses, hoses of rubber, flexible hoses of rubber, canvas hoses, fuel oil hoses, hoses of rubber for air conditioners, hoses of plastic for air conditioners, plastic hoses for plumbing use; sealing elements for sealing joints and crossing points in structural and civil engineering, in particular concrete construction, in the form of tapes, strips, plates, profiles etc. made of metal and in combination with plastic, joint tapes and joint sealing tapes made of plastic; surface sealing sheets made of plastic; expansion joint connections, namely, non-metal seals for use in the building and construction industries.

#### **Class 19**

(4) Construction materials (not of metal), namely, asphalt for building purposes, building boards of plastic, building cardboard, building glass, building paper, building sand, building stone, building timber, building strips of plastic, concrete construction blocks, concrete slabs for building, concrete walls for building, glass blocks for building, gravel, grout, lumber, marble used as building material; pipes for construction purposes, namely, cement pipes, concrete pipes, cement sewer pipes, ceramic drain pipes, concrete drain pipes, concrete sewer pipes, fibreglass drainage pipes, non-metal drain pipes, plastic branching pipes, plastic gutter pipes, plastic water pipes, pvc conduit pipes for building, pvc gutter pipes, pvc sewer pipes, pvc water pipes, shuttering pipes of paper or cardboard for concrete forming in the building and construction industry; injection hoses for concrete components; plastic pipe penetrations for concrete and sandwich construction; floor drains, roof drains and pump sumps, each of plastic; plastic shuttering; plastic load connectors, in particular plug connectors for construction purposes, of plastic; profile strips for construction purposes not of metal, namely, building strips of plastic.

#### **Class 20**

(5) Plastic fixing material for cable support and cable laying systems and elements; dowels, not made of metal, plastic anchors, in particular for concreting in concrete or for hollow wall elements; plugs, not made of metal, for anchor sleeves; holding brackets made of plastic.

#### **Services**

##### **Class 37**

Installation of building insulation and elevators; installation and assembly of cable support and laying systems.

#### **Claims**

Priority Filing Date: September 03, 2018, Country or Office: GERMANY, Application No: DE 30 2018 021 319.3 in association with the same kind of goods and in association with the same kind of services

**Application Number** 1,946,506  
**Language of Application** French

**Filing Date** 2019-02-15

## APPLICANT AND AGENT DETAILS

### Applicant

9384-2409 QUÉBEC INC., F.A.S. PRODUITS  
NATURE  
635 avenue de Gaspé Ouest  
Saint-Jean-Port-Joli  
QUÉBEC  
G0R3G0

### Agent

ROBIC  
630, boul. René-Lévesque Ouest, 20e étage,  
Montréal, QUÉBEC, H3B1S6

## TRADEMARK DETAILS

# PATELIN

### Trademark Type

Word

### Goods

#### Class 29

(2) Edible oils.

#### Class 30

(1) Vinaigrettes, salad dressings, mustards, marinade, mayonnaise.

**Application Number** 1,946,584  
**Language of Application** English

**Filing Date** 2019-02-15

## APPLICANT AND AGENT DETAILS

### Applicant

J-QuAD DYNAMICS Inc.  
2-3-1, Nihonbashi Muromachi  
Chuo-ku, Tokyo 103-0022  
JAPAN

### Agent

RICHEs, MCKENZIE & HERBERT LLP  
SUITE 1800, 2 BLOOR STREET EAST,  
TORONTO, ONTARIO, M4W3J5

## TRADEMARK DETAILS

# J-QuAD DYNAMICS

### Trademark Type

Word

### Goods

#### Class 09

Computer software for electronic control unit (ECU) for automobile engines for the purpose of self-driving and vehicle motion control; downloadable computer software for electronic control unit (ECU) for automobile engines for the purpose of self-driving and vehicle motion control; computer programs for electronic control unit (ECU) for automobile engines for the purpose of self-driving and vehicle motion control; downloadable computer programs for electronic control unit (ECU) for automobile engines for the purpose of self-driving and vehicle motion control; Downloadable music files featuring the operation of computer software for electronic control unit (ECU) for automobile engines for the purpose of self-driving and vehicle motion control; Downloadable video files and movie files featuring the operation of computer software for electronic control unit (ECU) for automobile engines for the purpose of self-driving and vehicle motion control; Recorded video discs and video tapes featuring the operation of computer software for electronic control unit (ECU) for automobile engines for the purpose of self-driving and vehicle motion control; Audio and video recordings featuring the operation of computer software for electronic control unit (ECU) for automobile engines for the purpose of self-driving and vehicle motion control; Downloadable musical sound recordings; Electronic publications, namely, book, magazine and manual featuring the operation of computer software for electronic control unit (ECU) for automobile engines for the purpose of self-driving and vehicle motion control recorded on computer media; Downloadable electronic publications, namely, book, magazine and manual featuring the operation of computer software for electronic control unit (ECU) for automobile engines for the purpose of self-driving and vehicle motion control

### Services

#### Class 42

design, programming and maintenance of computer software for electronic control units (ECUs) in automobile engines that controls vehicle autonomy and vehicle motion control; providing non-downloadable computer software for electronic control unit (ECU) for automobile engines for the purpose of self-driving and vehicle motion control; providing non-downloadable computer programs for electronic control unit (ECU) for automobile engines for the purpose of self-driving and vehicle motion control; cloud computing featuring computer software for electronic control

units (ECUs) in automobile engines that controls vehicle autonomy and vehicle motion control; rental of electronic circuits, magnetic discs, magnetic audio tapes and digital audio tapes, video discs, magnetic optical discs and other media, namely, USB flash drives, flash memory cards, flash memory chips, solid state drives, downloadable video files and video tapes, all the foregoing recorded with computer programs for electronic control units (ECUs) in automobile engines that control vehicle autonomy and vehicle motion control, digital data files that contain information in the fields of vehicle autonomy control, vehicle motion control and the operation of a vehicle; rental of computer software for electronic control unit (ECU) for automobile engines for the purpose of self-driving and vehicle motion control; rental of computers; design of machines, apparatus and instruments and their structural parts and systems composed thereof, namely, the design of Hardware-in-the-Loop Simulation (HILS) equipment for developing and testing computer software for electronic control units (ECUs) in automobiles that controls vehicle autonomy and vehicle motion control; technological advice relating to the operation of computer software for electronic control units (ECUs) in automobiles that controls vehicle autonomy and vehicle motion control; testing and research of computer software for electronic control units (ECUs) in automobile engines that controls vehicle autonomy and vehicle motion control

**Claims**

Priority Filing Date: December 13, 2018, Country or Office: JAPAN, Application No: 2018-153009 in association with the same kind of goods and in association with the same kind of services

**Application Number** 1,946,775  
**Language of Application** English

**Filing Date** 2019-02-19

## APPLICANT DETAILS

### Applicant

Oleksiy Komashchenko  
89 Drouin Ave  
Ottawa,  
ONTARIO  
K1K2A6

## TRADEMARK DETAILS

### Trademark Type

Design

### Visual Representation



# Kønugårnc

### Colour Claim

Colour is claimed as a feature of the trade-mark. The color of the trademark is black.

### Foreign Character Translation

The translation provided by the applicant is that the trademark contains two foreign characters from the North European languages: ø and å. In old Nordic language, the word Kønugård means a King's Town.

### Goods

#### Class 01

(1) currying preparations for skins

#### Class 03

(2) anti-aging skin care preparations; beauty care cosmetics; beauty creams for body care; body and beauty care cosmetics; body care soap; cleansing milk for skin care; cloths impregnated with a skin cleanser; cloths or tissues impregnated with a skin cleanser; cosmetic creams and lotions for face and body care; cosmetic creams for firming skin around eyes; cosmetic creams for skin care; cosmetic hair care preparations; cosmetic nail care preparations; cosmetic oils for the skin; cosmetic patches containing sunscreen and sun block for use on the skin; cosmetic preparations for dry skin during pregnancy; cosmetic preparations for hair care; cosmetic preparations for skin renewal; cosmetic skin care lotions; cosmetic skin care preparations; cosmetic skin fresheners; cosmetic skin lotions; cosmetics; cosmetics for use on the skin; cream for whitening the skin; deodorants for body care; emulsifying preparations for skin hydration; emulsions, gels and lotions for skin care; exfoliants for the skin; foot masks for skin care; hair care creams; hair care creams for cosmetic purposes; hair care lotions; hair care lotions for cosmetic purposes; hair care preparations; hair care preparations consisting of organic coconut virgin oil and coconut virgin oil; hand masks for skin care; lip care preparations; lotions for face and body care; lotions for face and body care for cosmetic purposes; moisturising skin lotions; moisturizing skin lotions; nail care kits; nail care preparations; non-medicated preparations for the care of hair; non-medicated preparations for the care of skin; non-medicated preparations for the care of the scalp; non-medicated skin care preparations; non-medicated skin creams; oil baths for hair care; oil baths for hair care for cosmetic purposes; patches containing sun screen and sun block for use on the skin; perfumed creams; perfumed powder; perfumed soaps; skin abrasives; skin bronzer; skin bronzing creams; skin care cosmetics; skin care creams; skin care lotions; skin care mousse; skin care preparations; skin clarifiers; skin cleansers; skin cleansing creams; skin cleansing foams; skin cleansing lotions; skin conditioners; skin conditioning creams for cosmetic purposes; skin creams; skin creams for cosmetic purposes; skin creams in liquid and solid form; skin emollients; skin emollients for cosmetic purposes; skin exfoliants; skin fresheners; skin gels for accelerating, enhancing or extending tans; skin lighteners; skin lightening creams; skin lotions; skin masks; skin masks for cosmetic purposes; skin moisturisers; skin moisturizer masks; skin moisturizers; skin moisturizing cream; skin moisturizing gel; skin polishing rice bran [arai-nuka]; skin scrub; skin soap; skin soaps; skin texturizers; skin toners; skin tonics; skin whitening creams; skin whitening preparations; soaps for body care; sun care lotions; sun care lotions for cosmetic purposes; sun care preparations; sun care preparations for cosmetic purposes; tissues impregnated with a skin cleanser; wipes impregnated with a skin cleanser; wrinkle removing skin care preparations

#### **Class 04**

(3) mineral oil for use in the manufacture of cosmetics and skin care products

#### **Class 05**

(4) adhesive bandages for skin wounds; alcohol-based antibacterial skin sanitizer gels; animal feed supplements; antibacterial skin soaps; botanicals for use in the treatment of dermatitis and skin pigmentation diseases; bracelets impregnated with insect repellent; dietary supplements for general health and well-being; herbal sore skin ointments for pets; herbal supplements for general health and well-being; homeopathic remedies for treatment of skin conditions, namely, dermatitis, eczema, psoriasis; medicated brush-on oral care gels; medicated cleansers for skin and wounds; mosquito repellants for application to the skin; pharmaceutical preparations for hydrating the skin during pregnancy; pharmaceutical preparations for preventing skin blemishes during pregnancy; pharmaceutical preparations for the treatment of bacterial skin infections, fungal skin infections, viral skin infections and parasitic skin infections; pharmaceutical preparations for the treatment of skin irritations, namely bee stings, sunburn, rashes, sores, corns, calluses, and acne; pharmaceutical preparations for treating dry skin caused by pregnancy; pharmaceutical preparations for use in dermatology, namely, dermatitis, skin pigmentation diseases, sexually

transmitted diseases; pharmaceutical products and preparations against dry skin caused by pregnancy; pharmaceutical products and preparations for hydrating the skin during pregnancy; preparations for cleansing the skin for medical use; processed human donor skin for the replacement of soft tissue; skin grafts; veterinary pharmaceutical preparations for udder care;

**Class 06**

(5) identification bracelets of metal; metal identification bracelets

**Class 09**

(6) encoded magnetic identification bracelets; fashion eyeglasses; fashion spectacles; magnetic encoded identification bracelets; magnetically encoded identification bracelets

**Class 14**

(7) ankle bracelets; ankle chains; anklet jewellery; bands for watches; bands for wristwatches; bangle bracelets; bangles; beads for making jewelry; beads for use in the manufacture of jewelry; bracelet charms; bracelets; bracelets for watches; bracelets for wristwatches; bracelets of precious metal; buckles for watch bands; buckles for watch straps; buckles for watchstraps; chains of precious metal for bracelets; charity bracelets; charms for bracelets; charms for jewelry; clasps for jewelry; cloisonné jewelry; custom jewelry; fitted jewelry pouches; friendship bracelets; gold bracelets; gold thread jewelry; gold-plated bracelets; hat jewelry; ivory jewelry; jewellery bracelets; jewellery chain of precious metal for bracelets; jewellery chains of precious metal for bracelets; jewelry; jewelry and imitation jewelry; jewelry boxes; jewelry brooches; jewelry cases; jewelry cases of precious metal; jewelry caskets of precious metal; jewelry chains; jewelry charms; jewelry clips for adapting pierced earrings to clip-on earrings; jewelry dishes; jewelry findings; jewelry for the head; jewelry hat pins; jewelry of yellow amber; jewelry organizer cases; jewelry organizer rolls for travel; jewelry rings; jewelry rolls for storage; jewelry rolls for travel; jewelry stickpins; jewelry watches; leather watch bands; leather watch straps; metal watch bands; metal watch straps; musical jewelry boxes; plastic watch bands; plastic watch straps; presentation boxes for jewelry; shoe jewelry; silver bracelets; silver jewelry; silver-plated bracelets; small jewelry boxes; straps for watches; straps for wristwatches; watch bands; watch bands and straps; watch bracelets; watch straps; watch straps made of metal or leather or plastic; watchbands; watches and straps for watches; watchstraps; watchstraps made of leather; watchstraps made of metal; watchstraps made of plastic; women's jewelry; wooden bead bracelets; wooden jewelry boxes; wrist watches; wristwatch bands; wristwatch bracelets; wristwatch straps; wristwatches

**Class 24**

(8) fabric of imitation animal skins; imitation animal skin fabrics; textile fabric of animal skins imitations; textile fabric of imitation animal skins

**Class 25**

(9) dresses made from skins; fashion hats

**Class 28**

(10) arm guards for athletic use; arm guards for sports use; guitar skins for electronic guitar game controllers

**Class 29**

(11) animal oils and fats for food; animal oils for food; artificial sausage skins; cannabis oil for food; dried fruit-based snack bars; fruit-based snack food; nut-based snack mixes; sausage skins made of natural gut; sausage skins made of synthetic materials; snack food dips; tofu skin

**Class 30**

(12) candy for food; cereal-based snack food; corn-based snack food; dumpling skins; granola-based snack bars; granola-based snack food; rice-based snack food; snack crackers; wheat-based snack food

**Class 31**

(13) animal food pellets; cat food; cattle food; dog food; pet food; puppy food

**Services**

**Class 42**

jewelry design



**Application Number** 1,946,854  
**Language of Application** English

**Filing Date** 2019-02-19

## **APPLICANT AND AGENT DETAILS**

### **Applicant**

PUK Group GmbH & Co. KG  
Nobelstraße 45-55  
12057 Berlin  
GERMANY

### **Agent**

MARKS & CLERK  
180 Kent Street, Suite 1900, Ottawa,  
ONTARIO, K1P0B6

## **TRADEMARK DETAILS**

### **Trademark Type**

Design

### **Visual Representation**

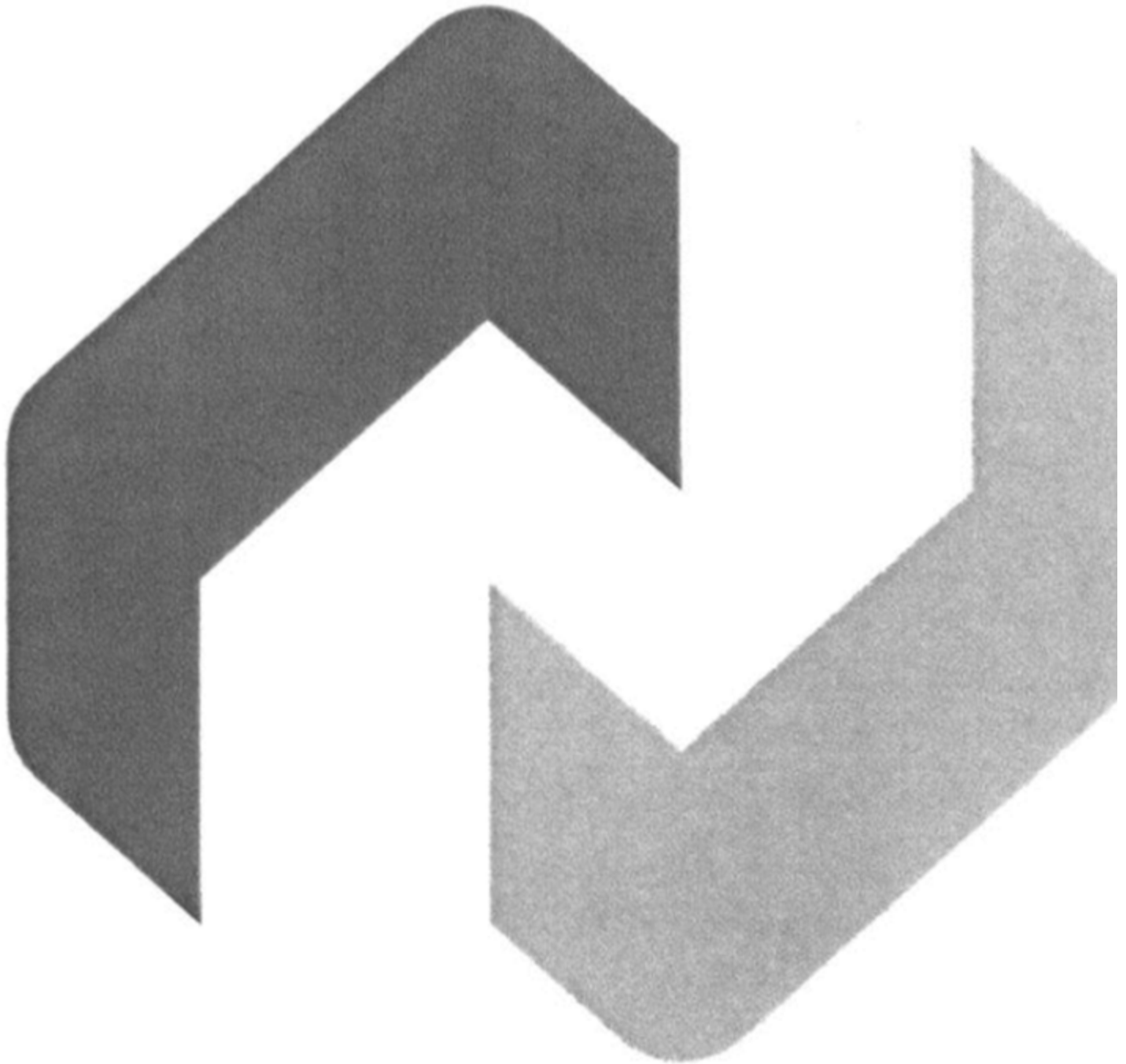
**Goods****Class 06**

(1) Metal building materials, namely, building boards of metal, building panels of metal, cladding of metal for building, expansion joints of metal for use in buildings, fittings of metal for building, flashing of metal for building, metal building flashing, metal pillars for building, metal trim for buildings, reinforcing materials of metal for building, tiles of metal for building; small items of metal hardware namely, bolts, nuts, screws, nails and springs; metal reinforcing materials for concrete, reinforcement rails, punching reinforcements, shear reinforcements, reinforcement anchors, double-head anchors, sandwich anchors, single shear pins; anchor rails, rail fastening rails and mounting rails, supports for such rails and parts to be suspended therefrom, namely, railing posts;

trapezoidal sheet metal fastening rails; connecting elements for concrete component, punched-through reinforcements, reinforcement connectors, namely, metal reinforcement connector bars; metal facing brackets, mortar brackets; metal support legs and metal wall shoe pegs, stair support bearings, for setting in concrete for use in construction and building; metal screws, metal nuts, rivets, and metal studs, hammer-head screws, toothed screws, hook-head screws and nuts, sliding nuts, dowels, sleeve dowels, transport anchors, double shear pins, anchors, sandwich anchors, support anchors, retaining anchors, retaining brackets, torsion anchors, anchor bolts, transport anchor bolts and retaining wedges, retaining brackets; anchor sleeves and screw sleeves with anchors for embedding in concrete; metal cables, metal cable loops; earthing bridges for concrete reinforcements; sheet metal strips, sealing sheet metal strips with non-metallic coating, each for sealing concrete construction joints; shuttering of expanded metal for concrete; load connectors, in particular plug connectors, made of metal; shaped boxes made of metal for use in the building industry; cable support and cable laying systems and elements; cable trays, cable conduits, cable ladders, also of lattice material, wide-span cable trays, cable support trays, cable clamps, non-electrical cable connections, fastening straps, supports for cable trays; metal fastening material for cables and pipes; metal laying and fastening materials for telecommunications.

### **Class 09**

(2) Cable distribution boxes and cable junction boxes; welding machines.

### **Class 17**

(3) Goods made of plastic, namely, semi-finished product in the form of plastic foils, rods, profiles, hoses, tubes and blocks; sealing, packing and insulating material, namely, sealing rings, seals of metal for preventing leakage of fluids, seals of metal for preventing leakage of gases, non-metallic seals for preventing the leakage of gases, non-metallic seals for preventing leakage of fluids, rubber sheets for sealing purposes, sealing gaskets of metal, bonded seals, composite seals, dynamic seals, moulded foam for packing, lowdensity polyurethane foam for packing, packing foam in sheet form, plastic packing for shipping containers, extruded polystyrene pellets for packing, plastic pellets for packing, rubber packing for shipping containers, rubber sheets for packing purposes, foils of metal for insulating, electrical insulation, fiberglass for insulation, foam glass for use as an insulating material, glass fibre insulation, glass wool for insulation, insulating fabrics, insulating foam in the form of blocks, insulating foam for use in building and construction; swelling tapes for sealing concrete joints; thermal and/or acoustic insulation panels, in particular for concrete component joints; air hoses, hoses of rubber, flexible hoses of rubber, canvas hoses, fuel oil hoses, hoses of rubber for air conditioners, hoses of plastic for air conditioners, plastic hoses for plumbing use; sealing elements for sealing joints and crossing points in structural and civil engineering, in particular concrete construction, in the form of tapes, strips, plates, profiles etc. made of metal and in combination with plastic, joint tapes and joint sealing tapes made of plastic; surface sealing sheets made of plastic; expansion joint connections, namely, non-metal seals for use in the building and construction industries.

### **Class 19**

(4) Construction materials (not of metal), namely, asphalt for building purposes, building boards of plastic, building cardboard, building glass, building paper, building sand, building stone, building timber, building strips of plastic, concrete construction blocks, concrete slabs for building, concrete walls for building, glass blocks for building, gravel, grout, lumber, marble used as building material; pipes for construction purposes, namely, cement pipes, concrete pipes, cement sewer pipes, ceramic drain pipes, concrete drain pipes, concrete sewer pipes, fibreglass drainage pipes, non-metal drain pipes, plastic branching pipes, plastic gutter pipes, plastic water pipes, pvc conduit pipes for building, pvc gutter pipes, pvc sewer pipes, pvc water pipes; shuttering pipes of paper or

cardboard for concrete forming in the building and construction industry; injection hoses for concrete components; plastic pipe penetrations for concrete and sandwich construction; floor drains, roof drains and pump sumps, each of plastic; plastic shuttering; plastic load connectors, in particular plug connectors for construction purposes, of plastic; profile strips for construction purposes not of metal, namely, building strips of plastic.

**Class 20**

(5) Plastic fixing material for cable support and cable laying systems and elements; dowels, not made of metal, plastic anchors, in particular for concreting in concrete or for hollow wall elements; plugs, not made of metal, for anchor sleeves; holding brackets made of plastic.

**Services****Class 37**

Installation of building insulation and elevators; installation and assembly of cable support and laying systems.

**Claims**

Priority Filing Date: September 03, 2018, Country or Office: GERMANY, Application No: DE 30 2018 021 320.7 in association with the same kind of goods and in association with the same kind of services

**Application Number** 1,946,925  
**Language of Application** English

**Filing Date** 2019-02-19

## **APPLICANT AND AGENT DETAILS**

### **Applicant**

St. Francis Herb Farm Incorporated  
P.O. Box 29  
Combermere  
ONTARIO  
K0J1L0

### **Agent**

BORDEN LADNER GERVAIS LLP  
World Exchange Plaza, 100 Queen Street,  
Suite 1300, Ottawa, ONTARIO, K1P1J9

## **TRADEMARK DETAILS**

### **Trademark Type**

Design

### **Visual Representation**

**Goods****Class 03**

(1) Herbal essential oils, namely, aromatic essential oils, aromatic essential oils for general health and well being, essential oils for cosmetic purposes, essential oils for personal use, essential oils for soothing the nerves, tea tree oil, oregano oil, herb extracts, other than essential oils, for use in the manufacture of health supplements

(2) Herbal cosmetic skin care preparations; herbal powders, namely, non-medicated herbal soap powders, non-medicated bath powders

**Class 05**

(3) Herbal health products, namely, herbal liquid extracts in the form of herbal gummies, herbal liquid extracts and herbal tinctures for the treatment of COX-2 inhibition for the reduction of

systemic inflammation, chronic congestive heart failure and declining cardiac performance, namely, fatigue, palpitations, shortness of breath and angina pain associated with ordinary physical activity, mild to moderate cholesterol levels and atherosclerosis, lactose intolerance, high cholesterol, high blood pressure, *Helicobacter pylori*, antibiotic-associated diarrhea, symptoms associated with an underactive thyroid, symptoms associated with a slow metabolism such as weight gain, sluggish thinking and low energy levels, mild glandular and tissue inflammation and swelling, colds, flu, viral infections such as colds and flu, herpes, HIV, pneumonia and chicken pox and immune disorders such as type 1 diabetes, multiple sclerosis, rheumatoid arthritis, lupus, Crohn's disease, psoriasis and scleroderma, mucous congestion, sinusitis, rhinitis, menopause and symptoms associated with menopause, inflammation and infection, arthritic pain, liver disorders, namely, liver congestion, chronic hepatitis, cirrhosis, and fatty degeneration, heart problems, urinary tract disorders, lymphatic disorder, crankiness, mood stabilization, digestive system disorders, glandular disease, stress, fatigue, prostate disease, reproductive disorders such as endometriosis, uterine fibroids, interstitial cystitis, polycystic ovary syndrome (PCOS), epididymitis, erectile dysfunction and prostatitis, nutritional imbalances, difficulties in breathing, skin conditions, namely, psoriasis, eczema, acne, boils and rashes, allergies, bacterial infections, viral infections, burns, catarrhal discharge, eczema, mumps, measles, scarlet fever, chicken pox, laryngitis, lymph congestion, snake bites, spider bites, insect bites, septicemia, prostate enlargements, ulceration of throat and mouth cavity, ulceration of skin and infected wounds, habitual constipation, lung infections and conditions, namely, acute and chronic bronchitis and coughs associated with respiratory tract infections, mild to medium depression, nervousness and restlessness, sleeplessness, anxiety and insomnia, colic, flatulent dyspepsia, namely, gas, bloating, burping, indigestion and fullness associated with digestion, cholesterol, hemorrhoids, teething problems in children, earaches, and to improve emotional balance, mental performance, cognitive function, blood purification, mineral absorption, immune function and preventing infections, blood flow, digestive upset, mental performance, concentration and memory, and to relieve itching, burning, redness, pimples and blemishes associated with Acne, and relief of upset stomach, symptoms of stomach flu, namely, nausea and diarrhea, joint pain and stiffness, pain associated with inflammatory musculo-skeletal conditions, namely, arthritis, polymyalgia, fibromyalgia, bursitis, tendonitis and the prevention of colon cancer, preventing harmful bacterial growth under stress, parasitic infection in the digestive system, and to reduce inflammation, neurological disorders; herbal capsule nutritional supplements for general health and wellbeing; herbal capsules; herbal cough syrups; herbal chest rubs in the nature of topical preparations for the chest to aid breathing, to promote recovery from colds and flu; herbal teas; pet herbal health products, namely, ear oil for the treatment of mites; nutritional supplements, namely, methylsulfonylmethane (MSM), Vitamin D preparations; homeopathic remedies for the treatment of seasonal allergies; functional foods, namely, powdered goat whey mineral, powdered goat milk protein, psyllium seed powder combination, coconut oil, olive oil, ghee, medium chain triglycerides (MCT); skin care products, namely salves and salve for skincare of pets, creams, lotions, gels, herbal oils, essential oils, magnesium chloride crystals; herbal tonics for medicinal and food use for general health and well-being; brochures, booklets, and newsletters in print and electronic form

(4) Herbal powders, namely, dry powdered herbal extracts for the treatment of habitual constipation, dry herbal powder mixes used as a bulk forming laxative to promote regularity, to treat mild to moderate hyperlipidaemia, used as a soothing demulcent for the symptomatic relief of irritation of the gastric mucosa and for digestive complaints such as bloating, flatulence, intestinal cramping and irritable bowel syndrome (IBS), to treat mild to moderately high cholesterol, blood pressure and blood sugar levels, herbal nutritional supplements in the form of powders for general health and well-being, plant-based protein dietary supplements in powder form; herbal lozenges, namely, herbal honey throat lozenges, herbal throat lozenges, herbal gummy lozenges for general

health and wellbeing, zinc supplement lozenges; herbal glycerites, namely, herbal glycerites for the treatment of habitual constipation, herbal glycerites for the treatment of restlessness, anxiety and insomnia, herbal glycerites for the treatment of crankiness, restlessness, sleeplessness, colic and digestive upset, teething problems in children, feverish cold and influenza and earaches in children, herbal glycerites for general health and wellbeing

(5) Herbal MCT extracts for general health and well-being

## **Services**

### **Class 44**

Providing information about dietary supplements and nutrition and herbal medicine; providing information and advice in the field of human health; providing information and advice in the field of pet health; providing information in the field of general health and wellness via a website; providing information in the fields of skincare, skincare product use, and beauty skin care; consultation services relating to skin care



**Application Number** 1,947,082  
**Language of Application** English

**Filing Date** 2019-02-20

## APPLICANT AND AGENT DETAILS

### Applicant

Topgolf Callaway Brands Corp.  
2180 Rutherford Road  
Carlsbad, CA 92008  
UNITED STATES OF AMERICA

### Agent

GOWLING WLG (CANADA) LLP  
SUITE 2600, 160 ELGIN STREET, OTTAWA,  
ONTARIO, K1P1C3

## TRADEMARK DETAILS

### Trademark Type

Position

### Visual Representation

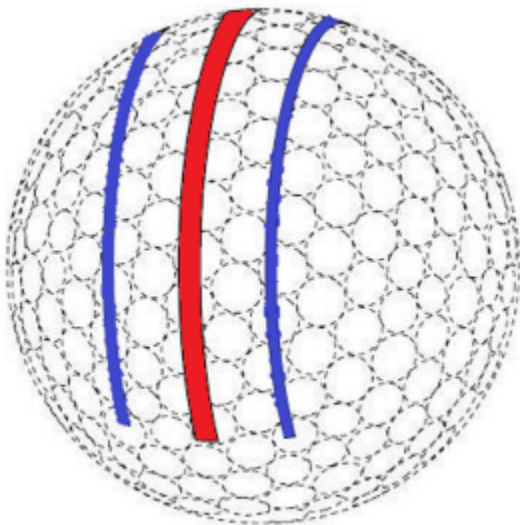

### Trademark Description

The trademark is the positioning of a sign and consists of three parallel lines wherein the middle line is red and thicker than the two outer blue lines which coloured lines are applied to the shape of a golf ball for which the colours red and blue are claimed as the feature of the trademark. The object golf ball shown in the dashed lines does not form part of the trademark but is included merely to show the positioning of the sign.

### Colour Claim

Colour is claimed as a feature of the trademark. The trademark is the positioning of a sign and consists of three parallel lines wherein the middle line is red and thicker than the two outer blue lines which coloured lines are applied to the shape of a golf ball for which the colours red and blue are claimed as the feature of the trademark.

### Goods

Class 28

golf balls

**Claims**

Priority Filing Date: November 27, 2018, Country or Office: UNITED STATES OF AMERICA,  
Application No: 88207645 in association with the same kind of goods

**Application Number** 1,947,165  
**Language of Application** English

**Filing Date** 2019-02-20

## APPLICANT AND AGENT DETAILS

### Applicant

Harmonist Inc.  
10736 Jefferson Blvd., Suite No. 963  
Culver City, CA 90230  
UNITED STATES OF AMERICA

### Agent

RIDOUT & MAYBEE LLP  
11 Holland Avenue, Suite 601 , Ottawa,  
ONTARIO, K1Y4S1

## TRADEMARK DETAILS

# SUN FORCE

### Trademark Type

Word

### Goods

#### Class 03

Perfume for linen, carpets and the atmosphere; oils for perfumery; essential oils, namely, essential oils for personal use, aromatic essential oils, essential oils for cosmetic purposes; home fragrances; bases for flower perfumes; extracts of flower being perfumes; cosmetics; eaux de toilette; perfumes; eaux de parfum; scented water; base for perfumes; soaps, namely, bath soap, body care soap, face soap, cosmetic soaps; toilet soaps;

**Application Number** 1,947,200  
**Language of Application** English

**Filing Date** 2019-02-20

## APPLICANT AND AGENT DETAILS

### Applicant

Bradshaw International, Inc.  
9409 Buffalo Ave.  
Rancho Cucamonga, CA 91730  
UNITED STATES OF AMERICA

### Agent

ANDREA FRIEDMAN-RUSH  
(BLANEY MCMURTRY LLP), 2 Queen Street  
East, Suite 1500, Toronto, ONTARIO, M5C3G5

## TRADEMARK DETAILS

# KIND

### Trademark Type

Word

### Goods

#### Class 21

cleaning products, namely kitchen sponges, scrub sponges, cloths for cleaning, scrubbing brushes, dish brushes, mops, brooms, hand and floor dusters

### Claims

Priority Filing Date: February 20, 2019, Country or Office: UNITED STATES OF AMERICA,  
Application No: 88/084/854 in association with the same kind of goods

**Application Number** 1,947,244  
**Language of Application** English

**Filing Date** 2019-02-20

## **APPLICANT AND AGENT DETAILS**

### **Applicant**

Kinstate, Inc.  
101 Larkspur Landing Circle, Suite 321  
Larkspur, CA 94939  
UNITED STATES OF AMERICA

### **Agent**

MILLER THOMSON LLP  
SCOTIA PLAZA, 40 KING STREET WEST,  
SUITE 5800, P.O. BOX 1011, TORONTO,  
ONTARIO, M5H3S1

## **TRADEMARK DETAILS**

### **Trademark Type**

Design

### **Visual Representation**

**Goods****Class 03**

(1) Terpenes; Essential oils for use as taste flavourings to sublingual cannabis-based strips.

**Class 05**

(2) Dried cannabis for medical purposes, for stress and pain relief; medicinal cannabis for reducing stress; medicinal cannabis for pain management; pharmaceutical preparations, namely sublingual strips containing cannabis, for stress and pain relief; cannabis oil for reducing stress; cannabis oil for pain management

**Services****Class 44**

Providing health and wellness information regarding the benefits of cannabis, cannabinoids, terpenes, and other plant extracts, and the bioavailability associated with a variety of delivery systems

**Claims**

Priority Filing Date: September 14, 2018, Country or Office: UNITED STATES OF AMERICA, Application No: 88117822 in association with the same kind of services

**Application Number** 1,947,259  
**Language of Application** English

**Filing Date** 2019-02-20

## APPLICANT AND AGENT DETAILS

**Applicant**  
OGEN LTD.  
5430 30th Street SE  
Calgary  
ALBERTA  
T2C1G2

**Agent**  
MBM INTELLECTUAL PROPERTY AGENCY  
275 SLATER STREET, 14TH FLOOR,  
OTTAWA, ONTARIO, K1P5H9

## TRADEMARK DETAILS

# OGEN

**Trademark Type**  
Word

**Goods**

**Class 03**

Cannabis oil for cosmetic purposes; Bath additives; bath herbs; bath oils; bath oils for cosmetic purposes; beauty care cosmetics; beauty creams for body care; beauty gels; beauty lotions; body and beauty care cosmetics; body creams; body oils; cosmetic creams; cosmetic oils; cosmetics and make-up; face and body lotions; face and body milk; face lotion; hair care preparations; hair styling preparations; hand cream; hand lotions; lip care preparations; lip conditioners; lip glosses; liquid soaps for hands, face and body; massage creams; massage oils; non-medicated bubble bath preparations; non-medicated preparations for the care of hair; non-medicated preparations for the care of skin; non-medicated preparations for the care of the scalp; non-medicated skin care preparations; oils for toiletry purposes; skin creams; skin emollients; skin lotions; skin soap; soaps for body care; soaps for personal use all containing cannabis plant derivatives; Skin care preparations; non-medicated cleansing preparations for the skin; lip balm; moisturizing balms, namely body balms, shaving balms, facial balms and hair balms, moisturizing body sprays; essential oils for aromatherapy; essential oils for personal use; massage oil; moisturizing balms, namely body balms, shaving balms, facial balms, hair balms, moisturizing body sprays, all containing cannabis plant derivatives; Topical skin creams, bar and liquid soaps for hands, face and body, bath additives, bath soaps, bath herbs, bath oils, body creams, body oils, face and body lotions, face and body milk, face and body cleansers, hand cream, hand lotions, lip care preparations, lip conditioners, skin creams, skin emollients, skin lotions, massage creams, massage oils, hair shampoos, hair conditioners, and leave-in hair treatments, namely leave-in hair treatment preparations for cosmetic purposes, hair repair treatments and keratin hair treatments, each containing cannabis or derivatives of cannabis, namely, cannabis resins and cannabis oils for cosmetic purposes



**Application Number** 1,947,307  
**Language of Application** English

**Filing Date** 2019-02-20

## APPLICANT AND AGENT DETAILS

### Applicant

Meng-Chee Mak-Karbach  
203 Kilgour Avenue  
Welland  
ONTARIO  
L3C2R1

### Agent

MILTONS IP/P.I.  
#200-15 Fitzgerald Road, Ottawa, ONTARIO,  
K2H9G1

## TRADEMARK DETAILS

### Trademark Type

Design

### Visual Representation



### Goods

#### Class 29

(1) soup mixes

#### Class 30

(2) Chutneys

(3) seasonings and dry rubs

(4) cake mixes and cookie mixes, cookies and pastries

#### Class 32

(5) smoothies

### Services

#### Class 35

(1) Offering technical assistance in the establishment and operation of restaurants;

#### Class 41

(2) training in recipe creation and development, sourcing ingredients and using seasonal ingredients; training in food preparation; developing training manuals in the field of restaurant operations

#### Class 44

(3) Consultancy relating to horticulture; Consulting in the field of agriculture, namely care and handling of farm equipment, soil composition, sowing crops, types of fertilizer and fertilizing

practices, work safety and sustainable farming, growing micro greens, transplanting of nursery plants, harvesting techniques

**Application Number** 1,947,580  
**Language of Application** French

**Filing Date** 2019-02-21

## APPLICANT AND AGENT DETAILS

**Applicant**  
REPAF - RÉSEAU DES ENTREPRENEURS  
ET PROFESSIONNELS AFRICAINS  
350-4950 Ch. Queen-Mary  
Montréal  
QUÉBEC  
H3W1X3

**Agent**  
BENOÎT & CÔTÉ INC.  
560 boul. Crémazie Est, 3e étage, Montréal,  
QUÉBEC, H2P1E8

## TRADEMARK DETAILS

**Trademark Type**  
Design

**Visual Representation**



**Services**

**Class 35**

(1) Network of entrepreneurs and professionals in order to develop an inter-professional approach between members of the business networking group; professional networking services provided to members; operation of a non-profit organization (NPO) for the promotion of the professional, commercial and business interests of network members; assistance and advice regarding business organization and management for the purpose of fostering the establishment of business

relationships between Africa and Canada; provision of information and positions about public relations to professionals, entrepreneurs, business people and students and a variety of socio-economic, municipal and governmental stakeholders.

#### **Class 41**

(2) Organization and conduct of meetings, seminars, conventions, colloquia, training workshops, conferences, discussion forums, in the field of entrepreneurship, promotion of cultural diversity and the professional integration of network members into Canadian society; online provision of non-downloadable digital publications in the form of articles and newsletters, containing information related to the network's services and activities in the field of socio-professional and entrepreneurial integration.

(3) Organization of merit-based competitions and gala events for recognizing and honouring the success, exemplariness and the excellence of professionals, entrepreneurs, business people, businesses, students as well as socially and politically engaged people.

**Application Number** 1,947,708  
**Language of Application** English

**Filing Date** 2019-02-22

## APPLICANT AND AGENT DETAILS

### Applicant

J-QuAD DYNAMICS Inc.  
2-3-1, Nihonbashi Muromachi  
Chuo-ku, Tokyo 103-0022  
JAPAN

### Agent

RICHEs, MCKENZIE & HERBERT LLP  
SUITE 1800, 2 BLOOR STREET EAST,  
TORONTO, ONTARIO, M4W3J5

## TRADEMARK DETAILS

**Trademark Type**

Design

**Visual Representation**

The logo for J-QUAD DYNAMICS is displayed in a large, bold, black, sans-serif font. The word "J-QUAD" is on the top line, and "DYNAMICS" is on the bottom line. The "J" has a distinctive hook that extends downwards and to the left. The "Q" has a thick, rounded body and a short tail. The "A" is a simple, wide, sans-serif character. The "D" is also a simple, wide, sans-serif character. The word "DYNAMICS" is in all caps and is slightly smaller than "J-QUAD".

**Goods**

**Class 09**

Computer software for electronic control unit (ECU) for automobile engines for the purpose of self-driving and vehicle motion control; downloadable computer software for electronic control unit (ECU) for automobile engines for the purpose of self-driving and vehicle motion control; computer programs for electronic control unit (ECU) for automobile engines for the purpose of self-driving and vehicle motion control; downloadable computer programs for electronic control unit (ECU) for automobile engines for the purpose of self-driving and vehicle motion control; Downloadable music files featuring the operation of computer software for electronic control unit (ECU) for automobile engines for the purpose of self-driving and vehicle motion control; Downloadable video files and movie files featuring the operation of computer software for electronic control unit (ECU) for automobile engines for the purpose of self-driving and vehicle motion control; Recorded video discs and video tapes featuring the operation of computer software for electronic control unit

(ECU) for automobile engines for the purpose of self-driving and vehicle motion control; Audio and video recordings featuring the operation of computer software for electronic control unit (ECU) for automobile engines for the purpose of self-driving and vehicle motion control; Downloadable musical sound recordings; Electronic publications, namely, book, magazine and manual featuring the operation of computer software for electronic control unit (ECU) for automobile engines for the purpose of self-driving and vehicle motion control recorded on computer media; Downloadable electronic publications, namely, book, magazine and manual featuring the operation of computer software for electronic control unit (ECU) for automobile engines for the purpose of self-driving and vehicle motion control

## **Services**

### **Class 42**

design, programming and maintenance of computer software for electronic control units (ECUs) in automobile engines that controls vehicle autonomy and vehicle motion control; providing non-downloadable computer software for electronic control unit (ECU) for automobile engines for the purpose of self-driving and vehicle motion control; providing non-downloadable computer programs for electronic control unit (ECU) for automobile engines for the purpose of self-driving and vehicle motion control; cloud computing featuring computer software for electronic control units (ECUs) in automobile engines that controls vehicle autonomy and vehicle motion control; rental of electronic circuits, magnetic discs, magnetic audio tapes and digital audio tapes, video discs, magnetic optical discs and other media, namely, USB flash drives, flash memory cards, flash memory chips, solid state drives, downloadable video files and video tapes, all the foregoing recorded with computer programs for electronic control units (ECUs) in automobile engines that control vehicle autonomy and vehicle motion control, digital data files that contain information in the fields of vehicle autonomy control, vehicle motion control and the operation of a vehicle; rental of computer software for electronic control unit (ECU) for automobile engines for the purpose of self-driving and vehicle motion control; rental of computers; design of machines, apparatus and instruments and their structural parts and systems composed thereof, namely, the design of Hardware-in-the-Loop Simulation (HILS) equipment for developing and testing computer software for electronic control units (ECUs) in automobiles that controls vehicle autonomy and vehicle motion control; technological advice relating to the operation of computer software for electronic control units (ECUs) in automobiles that controls vehicle autonomy and vehicle motion control; testing and research of computer software for electronic control units (ECUs) in automobile engines that controls vehicle autonomy and vehicle motion control

## **Claims**

Priority Filing Date: February 20, 2019, Country or Office: JAPAN, Application No: 2019-027439 in association with the same kind of goods and in association with the same kind of services

**Application Number** 1,947,888  
**Language of Application** English

**Filing Date** 2019-02-25

## APPLICANT DETAILS

### Applicant

Shenzhen Cloudvalley Maker Technology Co.,  
Ltd.  
No.604, Building 1, Houhai Lanyue Wanpan  
Yuehai Sub-district, Nanshan District  
Guangdong, Shenzhen, 518000  
CHINA

## TRADEMARK DETAILS

# CloudValley

### Trademark Type

Word

### Goods

#### Class 09

(1) bags adapted for laptops; cabinets for loudspeakers; cases for smartphones; cell phone straps; computer cables; computer hardware; computer keyboards; computer monitors; computer mouse; computer network adapters; computer network hubs; computer network routers; computer network switches; computer printers; computer scanners; computer screens; computer speakers; covers for smartphones; differential switches; dimmer switches; electric light dimmers; headphones; light switches; optical switches; power switches; pressure switches; sleeves for laptops; joysticks for use with computers, other than for video games;

#### Class 21

(2) clothing stretchers; drinking bottles for sports; drinking straws; fitted vanity cases; paper plates and paper cups; pottery; soap holders; watering devices namely watering cans, watering hoses, sprinklers for watering and parts and fittings for the aforesaid goods; Household or kitchen utensils and containers, namely, bowls, dishes and plates, table glassware, beverage glassware, cooking utensils, coffee sets, tea sets, cookware, cutting boards, dinnerware, drinking cups, glass dishes, whisks, tongs, ladles, spatulas, lifters, strainer, mixing spoons and spatulas;

(3) fitted toilet cases

**Application Number** 1,948,597  
**Language of Application** English

**Filing Date** 2019-02-27

## APPLICANT AND AGENT DETAILS

### Applicant

AeroSleep NV, naamloze vennootschap, a legal entity  
Waterkeringstraat 21  
9320 Erembodegem  
BELGIUM

### Agent

ROBIC  
630, boul. René-Lévesque Ouest, 20e étage,  
Montréal, QUEBEC, H3B1S6

## TRADEMARK DETAILS

# AeroSleep

### Trademark Type

Word

### Goods

#### Class 09

(1) Apparatus for recording, transmission and reproduction of sound and images, namely electronic baby monitoring listening devices, namely cameras and baby monitors; Measuring, detecting and monitoring instruments, indicators and controllers, namely, baby scales, baby alarms, motion detectors, baby monitors, video baby monitors.

#### Class 10

(2) Bedding and mats for lying on for medical use.  
(3) Mattress protectors, namely incontinence sheets, crib mattress pads and crib mattress covers.

#### Class 11

(4) Travel lights, namely portable night lamps; Electric night lights.

#### Class 20

(5) Changing mattresses, head boards, bolsters, sleeping mats, cribs, the aforesaid goods intended in particular for children and babies.  
(6) Mattresses, bumper pads, the aforesaid goods intended in particular for children and babies.  
(7) Cushions, pillows, the aforesaid goods intended in particular for children and babies.

#### Class 24

(8) Blankets, pillowcases, bed linen and bedspreads; towels, namely bath towels and hand towels; Sleeping bags; coverings for seats of textile and synthetic materials.  
(9) Mattress protectors, impermeable textiles for mattresses, the aforesaid goods intended in particular for children and babies.  
(10) Textiles and textile goods, namely textile fabrics, textiles for furniture, sheets, covers for pillows and cushions, coverings for (child's) beds.



**Application Number** 1,948,601  
**Language of Application** English

**Filing Date** 2019-02-27

## APPLICANT AND AGENT DETAILS

### Applicant

Tyler Technologies, Inc., a legal entity  
5101 Tennyson Parkway  
Plano, TX 75024  
UNITED STATES OF AMERICA

### Agent

RICHES, MCKENZIE & HERBERT LLP  
SUITE 1800, 2 BLOOR STREET EAST,  
TORONTO, ONTARIO, M4W3J5

## TRADEMARK DETAILS

# TYLER

### Trademark Type

Word

### Goods

#### Class 16

- (1) Forms for use in school administration, namely, student schedule forms, grade forms, attendance forms, and student record forms
- (2) Forms for use in school administration, namely, student schedule forms, grade forms, attendance forms, and student record forms

### Services

#### Class 35

- (1) Tax assessment services; consulting services in the fields of business process improvement, internal business management, and human resource management
- (2) Tax assessment services; consulting services in the fields of business process improvement, internal business management, and human resource management

#### Class 36

- (3) Real estate appraisal services; consulting services in the field of real estate appraisals and real and personal property appraisals for tax equalization purposes
- (4) Real estate appraisal services; consulting services in the field of real estate appraisals and real and personal property appraisals for tax equalization purposes

#### Class 42

- (5) Application service provider featuring software for use in notifying individuals of relevant event and scheduling updates and information, administration and management of property valuation data, and pension management; customized software development services; conversion of data or documents from physical to electronic media; data conversion of computer programs and data, not physical conversion; computer disaster recovery services, namely, disaster plan development, data monitoring and back up; testing, analysis, and evaluation of the knowledge, skills, and abilities of others for the purpose of software competency certification; and design, creation, hosting, and maintenance of websites for others; application service provider featuring software for use in accounting, accounts receivable management, financial management, asset management, procurement management, human resources management, time entry, payroll processing,

document management, court case management, municipal records management, school administration, management of teacher and student data, management of land and vital records, management of cemetery information, and law enforcement dispatching; application service provider featuring software for use in case management in the field of judicial systems, namely, indexing of judicial cases, electronic filing, docketing, scheduling, and related record keeping of case hearings, motions, documents, and deadlines, customizing judicial forms and documents, recording of in court minutes, management and tracking of warrants and warrant history, management of inmate history such as inmate intake, commissary management, cell assignments, risk assessments, and education, and fiscal management; consulting in the fields of information technology and business process technology

(6) Application service provider featuring software for use in notifying individuals of relevant event and scheduling updates and information, administration and management of property valuation data, and pension management; customized software development services; conversion of data or documents from physical to electronic media; data conversion of computer programs and data, not physical conversion; computer disaster recovery services, namely, disaster plan development, data monitoring and back up; testing, analysis, and evaluation of the knowledge, skills, and abilities of others for the purpose of software competency certification; and design, creation, hosting, and maintenance of websites for others; application service provider featuring software for use in accounting, accounts receivable management, financial management, asset management, procurement management, human resources management, time entry, payroll processing, document management, court case management, municipal records management, school administration, management of teacher and student data, management of land and vital records, management of cemetery information, and law enforcement dispatching; application service provider featuring software for use in case management in the field of judicial systems, namely, indexing of judicial cases, electronic filing, docketing, scheduling, and related record keeping of case hearings, motions, documents, and deadlines, customizing judicial forms and documents, recording of in court minutes, management and tracking of warrants and warrant history, management of inmate history such as inmate intake, commissary management, cell assignments, risk assessments, and education, and fiscal management; consulting in the fields of information technology and business process technology

**Application Number** 1,948,602  
**Language of Application** English

**Filing Date** 2019-02-27

## APPLICANT AND AGENT DETAILS

### Applicant

Tyler Technologies, Inc., a legal entity  
5101 Tennyson Parkway  
Plano, TX 75024  
UNITED STATES OF AMERICA

### Agent

RICHES, MCKENZIE & HERBERT LLP  
SUITE 1800, 2 BLOOR STREET EAST,  
TORONTO, ONTARIO, M4W3J5

## TRADEMARK DETAILS

### Trademark Type

Design

### Visual Representation



### Colour Claim

Colour is claimed as a feature of the trade-mark. The word 'tyler' is in blue.

### Goods

#### Class 16

(1) Forms for use in school administration, namely, student schedule forms, grade forms, attendance forms, and student record forms

(2) Forms for use in school administration, namely, student schedule forms, grade forms, attendance forms, and student record forms

## **Services**

### **Class 35**

(1) Tax assessment services; consulting services in the fields of business process improvement, internal business management, and human resource management

(2) Tax assessment services; consulting services in the fields of business process improvement, internal business management, and human resource management

### **Class 36**

(3) Real estate appraisal services; consulting services in the field of real estate appraisals and real and personal property appraisals for tax equalization purposes

(4) Real estate appraisal services; consulting services in the field of real estate appraisals and real and personal property appraisals for tax equalization purposes

### **Class 42**

(5) Application service provider featuring software for use in notifying individuals of relevant event and scheduling updates and information, administration and management of property valuation data, and pension management; customized software development services; conversion of data or documents from physical to electronic media; data conversion of computer programs and data, not physical conversion; computer disaster recovery services, namely, disaster plan development, data monitoring and back up; testing, analysis, and evaluation of the knowledge, skills, and abilities of others for the purpose of software competency certification; and design, creation, hosting, and maintenance of websites for others; application service provider featuring software for use in accounting, accounts receivable management, financial management, asset management, procurement management, human resources management, time entry, payroll processing, document management, court case management, municipal records management, school administration, management of teacher and student data, management of land and vital records, management of cemetery information, and law enforcement dispatching; application service provider featuring software for use in case management in the field of judicial systems, namely, indexing of judicial cases, electronic filing, docketing, scheduling, and related record keeping of case hearings, motions, documents, and deadlines, customizing judicial forms and documents, recording of in court minutes, management and tracking of warrants and warrant history, management of inmate history such as inmate intake, commissary management, cell assignments, risk assessments, and education, and fiscal management; consulting in the fields of information technology and business process technology

(6) Application service provider featuring software for use in notifying individuals of relevant event and scheduling updates and information, administration and management of property valuation data, and pension management; customized software development services; conversion of data or documents from physical to electronic media; data conversion of computer programs and data, not physical conversion; computer disaster recovery services, namely, disaster plan development, data monitoring and back up; testing, analysis, and evaluation of the knowledge, skills, and abilities of others for the purpose of software competency certification; and design, creation, hosting, and maintenance of websites for others; application service provider featuring software for use in accounting, accounts receivable management, financial management, asset management, procurement management, human resources management, time entry, payroll processing, document management, court case management, municipal records management, school administration, management of teacher and student data, management of land and vital records,

management of cemetery information, and law enforcement dispatching; application service provider featuring software for use in case management in the field of judicial systems, namely, indexing of judicial cases, electronic filing, docketing, scheduling, and related record keeping of case hearings, motions, documents, and deadlines, customizing judicial forms and documents, recording of in court minutes, management and tracking of warrants and warrant history, management of inmate history such as inmate intake, commissary management, cell assignments, risk assessments, and education, and fiscal management; consulting in the fields of information technology and business process technology

**Application Number** 1,948,661  
**Language of Application** English

**Filing Date** 2019-02-27

## APPLICANT AND AGENT DETAILS

### Applicant

Venerable Holdings, Inc.  
1475 Dunwoody Drive  
West Chester, PA 19380  
UNITED STATES OF AMERICA

### Agent

CHANTAL ST. DENIS  
(O'BRIEN TM SERVICES INC), 262, chemin  
Eardley, Gatineau, QUEBEC, J9J2Y7

## TRADEMARK DETAILS

# VENERABLE

### Trademark Type

Word

### Services

#### Class 36

Insurance services, namely, administering and managing life insurance policies, fixed annuities, and variable annuities; reinsurance of life insurance, fixed annuities, and variable annuities.

### Claims

Priority Filing Date: September 04, 2018, Country or Office: UNITED STATES OF AMERICA,  
Application No: 88103141 in association with the same kind of services

**Application Number** 1,948,866  
**Language of Application** English

**Filing Date** 2019-02-28

## APPLICANT AND AGENT DETAILS

### Applicant

Philip Morris Products S.A.  
Quai Jeanrenaud 3  
Neuchâtel, 2000  
SWITZERLAND

### Agent

GOWLING WLG (CANADA) LLP  
SUITE 1600, 1 FIRST CANADIAN PLACE, 100  
KING STREET WEST, TORONTO, ONTARIO,  
M5X1G5

## TRADEMARK DETAILS

# UNSMOKE

### Trademark Type

Standard Characters

### Services

#### Class 41

Educational services in the field of tobacco substitute products; the provision of training and coaching in the field of tobacco substitute products; providing educational information namely news, editorials, research, opinions, instructional examinations and practical demonstrations in the field of tobacco substitute products; publication of books and magazines

### Claims

Priority Filing Date: September 06, 2018, Country or Office: GERMANY, Application No: 302018109948.3 in association with the same kind of services

**Application Number** 1,949,611  
**Language of Application** English

**Filing Date** 2019-03-05

## APPLICANT AND AGENT DETAILS

### Applicant

Amazon Technologies, Inc.  
410 Terry Ave N  
Seattle, WA 98109  
UNITED STATES OF AMERICA

### Agent

CLARK WILSON LLP  
900 - 885 WEST GEORGIA STREET,  
VANCOUVER, BRITISH COLUMBIA, V6C3H1

## TRADEMARK DETAILS

# RE:INVENT

### Trademark Type

Standard Characters

### Services

#### Class 41

Educational services, namely, conducting conferences, seminars, classes, and workshops in the fields of web services and cloud computing

### Claims

Priority Filing Date: October 24, 2018, Country or Office: UNITED STATES OF AMERICA,  
Application No: 88168125 in association with the same kind of services



**Application Number** 1,949,613  
**Language of Application** English

**Filing Date** 2019-03-05

## APPLICANT AND AGENT DETAILS

### Applicant

Organika Health Products Inc.  
13480 Verdun Place  
Richmond  
BRITISH COLUMBIA  
V6V1V2

### Agent

COASTAL TRADEMARK SERVICES LIMITED  
301-543 Granville Street, Vancouver, BRITISH  
COLUMBIA, V6C1X8

## TRADEMARK DETAILS

# ORGANIKA FULL SPECTRUM COLLAGEN

### Trademark Type

Standard Characters

### Goods

#### Class 03

(1) skin care preparations; health and beauty aids, namely, facial and body cleansers, body lotions, skin conditioners, skin creams, skin lighteners, beauty masks, skin peels, skin toners, body scrubs and facial scrubs, bath gels, body gels, and shower gels, pore refiners, exfoliator, body mists, beauty serums, bath powder, bath talc, body moisturizers and facial moisturizers, shampoos, hair conditioners, shaving gels and foams, bronzers and sunscreens, cosmetics for the eyes, face, lips and nails;

#### Class 05

(2) dietary supplements to support joint health, joint care and flexibility, and to improve complexity of the skin; nutritional supplements in capsule, tablet, powder and liquid form used for healthy aging; nutraceuticals, namely anti-aging creams, sun block preparations, vitamins and minerals

**Application Number** 1,949,746  
**Language of Application** French

**Filing Date** 2019-03-06

## APPLICANT AND AGENT DETAILS

### Applicant

Corporation de Services Mallet  
2655 rue Guillaume-Le Pelletier  
Québec  
QUÉBEC  
G1C3X7

### Agent

FASKEN MARTINEAU DUMOULIN S.E.N.C.R.  
L., SRL  
365, rue Abraham-Martin, bureau 600,  
Québec, QUÉBEC, G1K8N2

## TRADEMARK DETAILS

**Trademark Type**

Design

**Visual Representation**



### Services

#### Class 35

(1) Residential home management services.

#### Class 37

(2) Housekeeping services.

#### Class 43

(3) Food and drink catering services; housing services for seniors and people in need.

**Class 44**

(4) Medical care services, namely geriatric nursing.

**Application Number** 1,949,874  
**Language of Application** English

**Filing Date** 2019-03-06

## APPLICANT AND AGENT DETAILS

### Applicant

HHG IPCo, LLC  
1411 Broadway, Fourth Floor  
New York, NY 10018  
UNITED STATES OF AMERICA

### Agent

GOWLING WLG (CANADA) LLP  
SUITE 2600, 160 ELGIN STREET, OTTAWA,  
ONTARIO, K1P1C3

## TRADEMARK DETAILS

# DREXEL HERITAGE

### Trademark Type

Word

### Goods

#### Class 11

Lighting fixtures, electric lighting fixtures, lamps, namely, electric lamps, floor lamps, hanging lamps, headlamps, lamp shades, ceiling fans.

**Application Number** 1,950,045  
**Language of Application** English

**Filing Date** 2019-03-07

## APPLICANT AND AGENT DETAILS

### Applicant

Bell Mobility Inc. / Bell Mobilité inc.  
1 Carrefour Alexander-Granham-Bell, Building  
A7  
Verdun  
QUEBEC  
H3E3B3

### Agent

APRIL AVOCATS, S.E.N.C. / APRIL  
LAWYERS, G.P.  
1, carrefour Alexander-Graham-Bell, Tour A-7 ,  
Verdun, QUEBEC, H3E3B3

## TRADEMARK DETAILS

# CONNECT EVERYTHING

### Trademark Type

Word

### Services

#### Class 38

Telecommunication services, namely providing multiple user access to a global computer network; Providing Internet access via wireless broadband networks; Cellular text messaging services; Digital text messaging; Electronic mail services through wired and wireless access; Voice messaging services; Wireless digital messaging services; Recording, storage and subsequent transmission of voice and text messages by telephone; Wireless telephone services.

**Application Number** 1,950,046  
**Language of Application** English

**Filing Date** 2019-03-07

## APPLICANT AND AGENT DETAILS

### Applicant

Bell Mobility Inc. / Bell Mobilité inc.  
1 Carrefour Alexander-Granham-Bell, Building  
A7  
Verdun  
QUEBEC  
H3E3B3

### Agent

APRIL AVOCATS, S.E.N.C. / APRIL  
LAWYERS, G.P.  
1, carrefour Alexander-Graham-Bell, Tour A-7 ,  
Verdun, QUEBEC, H3E3B3

## TRADEMARK DETAILS

# CONNECTEZ TOUT

### Trademark Type

Word

### Services

#### Class 38

Telecommunication services, namely providing multiple user access to a global computer network; Providing Internet access via wireless broadband networks; Cellular text messaging services; Digital text messaging; Electronic mail services through wired and wireless access; Voice messaging services; Wireless digital messaging services; Recording, storage and subsequent transmission of voice and text messages by telephone; Wireless telephone services.

**Application Number** 1,950,392  
**Language of Application** English

**Filing Date** 2019-03-08

## APPLICANT AND AGENT DETAILS

### Applicant

DAIKYO SEIKO, LTD.  
1305-1 Kurohakama-cho  
Sano-shi, Tochigi-ken, 327-0813  
JAPAN

### Agent

SMART & BIGGAR LP  
SUITE 900, 55 METCALFE STREET, P.O.  
BOX 2999, STATION D, OTTAWA, ONTARIO,  
K1P5Y6

## TRADEMARK DETAILS

# Daikyo 690

### Trademark Type

Word

### Foreign Character Translation

The translation provided by the applicant of the Japanese words "DAI" and "KYO" is "big" or "great" and "cooperation" or "harmonization". Therefore "DAIKYO" could be translated from Japanese to "great cooperation" or "great harmonization" in English. .

### Goods

#### Class 10

(1) Rubber infusion bottle stoppers for medical use; rubber infusion bottle closures for medical use; medical rubber caps for syringe barrels; medical syringes; medical syringe barrels; pistons for medical syringes; plungers for medical syringes; flange adaptors for use with medical syringe barrels; nozzle caps for medical syringes; medical injection instruments with needles.

#### Class 17

(2) Rubber O-rings; rubber lids for shipping containers; semi-worked plastic in bars, blocks, pellets, rods, sheets, tubes or extruded form for general industrial or manufacturing use; rubber, raw and semi-worked.

#### Class 20

(3) Packaging containers of plastics; medicine storage packaging containers of plastics; rubber closures for medicine containers.

#### Class 21

(4) Vial-shaped plastic bottles; plastic bottles; vial-shaped plastic bottles for medical chemicals.

**Application Number** 1,950,393  
**Language of Application** English

**Filing Date** 2019-03-08

## APPLICANT AND AGENT DETAILS

### Applicant

DAIKYO SEIKO, LTD.  
1305-1 Kurohakama-cho  
Sano-shi, Tochigi-ken, 327-0813  
JAPAN

### Agent

SMART & BIGGAR LP  
SUITE 900, 55 METCALFE STREET, P.O.  
BOX 2999, STATION D, OTTAWA, ONTARIO,  
K1P5Y6

## TRADEMARK DETAILS

# Daikyo DX

### Trademark Type

Word

### Foreign Character Translation

The translation provided by the applicant of the Japanese words "DAI" and "KYO" is "big" or "great" and "cooperation" or "harmonization". Therefore "DAIKYO" could be translated from Japanese to "great cooperation" or "great harmonization".

### Goods

#### Class 10

(1) Rubber infusion bottle stoppers for medical use; rubber infusion bottle closures for medical use; medical rubber caps for syringe barrels; medical syringes; medical syringe barrels; pistons for medical syringes; plungers for medical syringes; flange adaptors for use with medical syringe barrels; nozzle caps for medical syringes; medical injection instruments with needles.

#### Class 17

(2) Rubber O-rings; rubber lids for shipping containers; semi-worked plastic in bars, blocks, pellets, rods, sheets, tubes or extruded form for general industrial or manufacturing use; rubber, raw and semi-worked.

#### Class 20

(3) Packaging containers of plastics; medicine storage packaging containers of plastics; rubber closures for medicine containers.

#### Class 21

(4) Vial-shaped plastic bottles; plastic bottles; vial-shaped plastic bottles for medical chemicals.



**Application Number** 1,950,649  
**Language of Application** English

**Filing Date** 2019-03-11

## APPLICANT AND AGENT DETAILS

### Applicant

Canadian Society of Physician Leaders  
875 Carling Avenue, Suite 323  
Ottawa  
ONTARIO  
K1S5P1

### Agent

NELLIGAN O'BRIEN PAYNE LLP  
300-50 O'CONNOR STREET, OTTAWA,  
ONTARIO, K1P6L2

## TRADEMARK DETAILS

### Trademark Type

Design

### Visual Representation



### Colour Claim

Colour is claimed as a feature of the trade-mark. The maple leaf and the letters CCPE are purple. The first upper swoosh design is in gradients of grey and the second lower swoosh design is in gradients of orange. The dots above and below the maple leaf are orange.

### Services

#### Class 41

Granting professional certification in the field of senior medical leadership through a multilevel assessment process

**Application Number** 1,950,780  
**Language of Application** English

**Filing Date** 2019-03-11

## APPLICANT AND AGENT DETAILS

### Applicant

Tiny Love Ltd.  
72 Pinchas Rosen Street  
Top Dan Bldg., Floor D  
Tel Aviv  
ISRAEL

### Agent

BORDEN LADNER GERVAIS LLP  
ATTN: INTELLECTUAL PROPERTY  
DEPARTMENT, 1000 DE LA GAUCHETIERE  
STREET WEST, SUITE 900, MONTREAL,  
QUEBEC, H3B5H4

## TRADEMARK DETAILS

### Trademark Type

Design

### Visual Representation



### Colour Claim

Colour is claimed as a feature of the trade-mark. The letters of the words TINY and LOVE are in the color white. The dialogue baloon is in the color red.

### Goods

#### Class 16

(1) Printed publications, magazines, brochures, newsletters, posters books, booklets, pamphlets, catalogues, printed paper signs, stickers, all in the field of child care, parenting, child raising, child development and child education.

#### Class 20

(2) Baby and infant bouncers; baby and infant rocker nappers; cradles; baby and infant walkers; baby and infant walkers also comprising of a multiple activity center; baby and infant playpens; baby and infant changing mats.

### **Class 28**

(3) Games, toys and playthings for babies, infants and children, namely, plush and plastic animals, plush and plastic toy figures, bath toys, playing cups, plush and plastic fruits, plush and plastic activity toys in the shape of books, plush and plastic toy vehicles, baby activity centers comprised, multiple activity toys, play mats containing infant toys, play mats for use with toy vehicles, flexible toy rings, plush and plastic balls, baby toy mobiles, crib toys, baby toy wind chimes, mirror toys, baby rattlers incorporating teething rings, squeaker toys, rattlers, musical toys, peek-a-boo toys, namely, stuffed toys that have hidden three-dimensional or graphic elements which are revealed when exposed, peek-a-boo toys, namely, multiple activity toys that have hidden three-dimensional or graphic elements which are revealed when exposed, peek-a-boo toys, namely, electronic learning toys that have hidden three-dimensional or graphic elements which are revealed when exposed, stacking toys, scented plush toys in the nature of plush toys containing a scent, sorting toys, namely, a combination of sortable toy elements of varying shapes or sizes which are to be fit into corresponding areas of a receiving element; toys in the nature of playsets designed to be attached to strollers, car seat and bouncers, toys in the nature of playsets designed to be attached to cribs and playpens, children's multiple activity toys, electronic learning toys, toys with LED light features in the nature of baby multiple activity toys and toy mobiles featuring LED lights, sound toy machines in the nature of electronic learning toys that electronically record, play back, and distort or and manipulate voices and sounds; electronic action toys, plush toys and hard and soft sculpture toys with light emitting devices that light up as night lights, ceiling projectors, lanterns and projectors; toy tricycles for children; toy scooters and accessories therefor; ride-on toys; rideable toy vehicles; ride-on toy vehicles (Motorized -); rideable toys and accessories therefor.

### **Services**

#### **Class 41**

Provision of educational information and advice, electronic publications and discussion forums in the field of child care, parenting, child raising, child development and child education, by means of global computer networks.

### **Claims**

Priority Filing Date: January 21, 2019, Country or Office: ISRAEL, Application No: 312904 in association with the same kind of goods and in association with the same kind of services

**Application Number** 1,950,813  
**Language of Application** English

**Filing Date** 2019-03-11

## APPLICANT AND AGENT DETAILS

### Applicant

Devan Kline Fitness, LLC  
311 Gilead Road  
Huntersville, NC 28078  
UNITED STATES OF AMERICA

### Agent

CASSELS BROCK & BLACKWELL LLP  
SCOTIA PLAZA, SUITE 2100, 40 KING  
STREET WEST, TORONTO, ONTARIO,  
M5H3C2

## TRADEMARK DETAILS

# COFFEE & KETTLEBELLS

### Trademark Type

Word

### Services

#### Class 41

Entertainment services, namely, providing podcasts in the field of general health and well-being, fitness, nutrition, and living a healthy lifestyle; educational services, namely, providing podcasts in the field of general health and well-being, fitness, nutrition, and living a healthy lifestyle.

### Claims

Priority Filing Date: September 18, 2018, Country or Office: UNITED STATES OF AMERICA,  
Application No: 88121160 in association with the same kind of services

**Application Number** 1,950,933  
**Language of Application** English

**Filing Date** 2019-03-12

## APPLICANT AND AGENT DETAILS

### Applicant

Google LLC  
1600 Amphitheatre Parkway  
Mountain View, CA 94043  
UNITED STATES OF AMERICA

### Agent

CLARK WILSON LLP  
900 - 885 WEST GEORGIA STREET,  
VANCOUVER, BRITISH COLUMBIA, V6C3H1

## TRADEMARK DETAILS

# ADIANTUM

### Trademark Type

Standard Characters

### Goods

#### Class 09

Computer software, namely, open source software for use in the encryption and decryption of digital files

### Claims

Priority Filing Date: March 06, 2019, Country or Office: UNITED STATES OF AMERICA,  
Application No: 88/327,856 in association with the same kind of goods

**Application Number** 1,951,533  
**Language of Application** English

**Filing Date** 2019-03-14

## APPLICANT AND AGENT DETAILS

### Applicant

Comida Taqueria Ltd.  
235 12 Ave SW  
Calgary  
ALBERTA  
T2R1H7

### Agent

PROWSE CHOWNE LLP  
#1450, 10020-101A Avenue NW, Edmonton,  
ALBERTA, T5J3G2

## TRADEMARK DETAILS

### Trademark Type

Design

### Visual Representation



**Services****Class 35**

(1) Offering technical assistance in the establishment and operation of bar and restaurant franchises.

**Class 39**

(2) Delivery of food by a restaurant.

**Class 41**

(3) Event planning; Party planning

**Class 43**

(4) Food and drink catering; Bar and restaurant services; Take out restaurant services; Catering services for hospitality suites; Rental of rooms for social functions; Providing information about bar and restaurant services

**Class 45**

(5) Organization of private social events

**Application Number** 1,951,540  
**Language of Application** English

**Filing Date** 2019-03-14

## APPLICANT AND AGENT DETAILS

### Applicant

Comida Taqueria Ltd.  
235 12 Ave SW  
Calgary  
ALBERTA  
T2R1H7

### Agent

PROWSE CHOWNE LLP  
#1450, 10020-101A Avenue NW, Edmonton,  
ALBERTA, T5J3G2

## TRADEMARK DETAILS

### Trademark Type

Design

### Visual Representation





**Services****Class 35**

(1) Offering technical assistance in the establishment and operation of bar and restaurant franchises.

**Class 39**

(2) Delivery of food by a restaurant.

**Class 41**

(3) Event planning; Party planning

**Class 43**

(4) Food and drink catering; Bar and restaurant services; Take out restaurant services; Catering services for hospitality suites; Rental of rooms for social functions; Providing information about bar and restaurant services

**Class 45**

(5) Organization of private social events

Application Number 1,951,547  
Language of Application English

Filing Date 2019-03-14

## APPLICANT AND AGENT DETAILS

### Applicant

Comida Taqueria Ltd.  
235 12 Ave SW  
Calgary  
ALBERTA  
T2R1H7

### Agent

PROWSE CHOWNE LLP  
#1450, 10020-101A Avenue NW, Edmonton,  
ALBERTA, T5J3G2

## TRADEMARK DETAILS

### Trademark Type

Design

### Visual Representation



**Services****Class 35**

(1) Offering technical assistance in the establishment and operation of bar and restaurant franchises.

**Class 39**

(2) Delivery of food by a restaurant.

**Class 41**

(3) Event planning; Party planning

**Class 43**

(4) Food and drink catering; Bar and restaurant services; Take out restaurant services; Catering services for hospitality suites; Rental of rooms for social functions; Providing information about bar and restaurant services

**Class 45**

(5) Organization of private social events

**Application Number** 1,951,644  
**Language of Application** English

**Filing Date** 2019-03-14

## APPLICANT AND AGENT DETAILS

### Applicant

Comida Taqueria Ltd.  
235 12 Ave SW  
Calgary  
ALBERTA  
T2R1H7

### Agent

PROWSE CHOWNE LLP  
#1450, 10020-101A Avenue NW, Edmonton,  
ALBERTA, T5J3G2

## TRADEMARK DETAILS

### Trademark Type

Design

### Visual Representation



### Services

#### Class 35

(1) Offering technical assistance in the establishment and operation of bar and restaurant franchises.

#### Class 39

(2) Delivery of food by a restaurant.

#### Class 41

(3) Event planning; Party planning

#### Class 43

(4) Food and drink catering; Bar and restaurant services; Take out restaurant services; Catering services for hospitality suites; Rental of rooms for social functions; Providing information about bar and restaurant services

#### Class 45

(5) Organization of private social events

**Application Number** 1,951,647  
**Language of Application** English

**Filing Date** 2019-03-14

## APPLICANT AND AGENT DETAILS

### Applicant

Comida Taqueria Ltd.  
235 12 Ave SW  
Calgary  
ALBERTA  
T2R1H7

### Agent

PROWSE CHOWNE LLP  
#1450, 10020-101A Avenue NW, Edmonton,  
ALBERTA, T5J3G2

## TRADEMARK DETAILS

### Trademark Type

Design

### Visual Representation



### Services

#### Class 35

(1) Offering technical assistance in the establishment and operation of bar and restaurant franchises.

#### Class 39

(2) Delivery of food by a restaurant.

#### Class 41

(3) Event planning; Party planning

#### Class 43

(4) Food and drink catering; Bar and restaurant services; Take out restaurant services; Catering services for hospitality suites; Rental of rooms for social functions; Providing information about bar and restaurant services

**Class 45**

(5) Organization of private social events

**Application Number** 1,951,754  
**Language of Application** English

**Filing Date** 2019-03-15

## APPLICANT AND AGENT DETAILS

### Applicant

ANDY HOLDINGS INC.  
3950 rue Hickmore, Suite 105  
Ville St-Laurent  
QUEBEC  
H4T1K2

### Agent

ROBIC  
630, boul. René-Lévesque Ouest, 20e étage,  
Montréal, QUEBEC, H3B1S6

## TRADEMARK DETAILS

# ANDY

### Trademark Type

Word

### Services

#### Class 36

(1) real estate management, real estate investment, real estate consultancy;

#### Class 37

(2) vehicle repair and maintenance; emergency road side assistance; real estate development;

#### Class 39

(3) freight transportation by truck; supply chain logistics and reverse logistics services consisting of the delivery of goods for others by truck; supply chain logistics and reverse logistics services consisting of the storage of goods for others by truck; supply chain logistics and reverse logistics services consisting of the transportation of goods for others by truck;

(4) packing, crating and warehousing services; rental of warehouses; warehouse storage services; Product palletization services for transportation purposes; Vehicle towing services;

(5) freight forwarding services; supply chain logistics and reverse logistics services consisting of the delivery of goods for others by air, rail or ship; supply chain logistics and reverse logistics services consisting of the storage of goods for others by air, rail or ship; supply chain logistics and reverse logistics services consisting of the transportation of goods for others by air, rail or ship;



**Application Number** 1,952,022  
**Language of Application** English

**Filing Date** 2019-03-18

## APPLICANT AND AGENT DETAILS

### Applicant

CANADA ROYAL MILK ULC  
1680 Venture Drive  
Kingston  
ONTARIO  
K7P0E9

### Agent

BENNETT JONES LLP  
4500 BANKERS HALL EAST, 855 - 2ND  
STREET S.W., CALGARY, ALBERTA, T2P4K7

## TRADEMARK DETAILS

### Trademark Type

Design

### Visual Representation



### Foreign Character Translation

The translation provided by the applicant of the word Aelpein is a paraphrase that means, in English, 'Love is our foundation, on which we are committed to sharing our values of life'.

### Foreign Character Transliteration

The transliteration provided by the applicant of the Chinese characters is Aelpein.

### Goods

Class 05

(1) Infant formula; Infant milk powder; Infant flour contains milk; Infant food; Nutritional supplements for general health and well-being; Protein powder dietary supplements; Infant diapers; Casein protein dietary supplements; Vitamin preparations; Dietary fiber as a food additive; Dietary fiber to aid digestion.

**Class 29**

(2) Milk; Milk powder; Milk products; Edible fat and oil; Edible birds nest; Roasted nuts; Blanched nuts; Processed nuts; Flavoured nuts; Soy milk (mainly milk); Yogurt; Goat milk; Goat yogurt.

**Services****Class 35**

Advertising flyer distribution; Sales demonstration for others; Advertising the services of others through all public communication means; Sales demonstration via the internet for the retail sale of infant formula, infant milk powder, infant flour containing milk, infant food, nutritional supplements, protein dietary supplements, infant diapers, casein protein dietary supplements, vitamin preparations, dietary fiber, milk, milk powder, milk products, edible fats and oil, edible bird's nest, roasted nuts, soy milk (mainly milk), yogurt, goat milk, goat yogurt; Providing commercial and business information in the field of nutrition via a website; Promoting the sale of goods and services of others through an online retail store relating to nutrition, infant foods, milk and milk products, and dietary supplements for general health and well-being; Providing online market for buyer and seller of goods and service; Providing advice and information relating to commercial business management.

**Application Number** 1,952,047  
**Language of Application** English

**Filing Date** 2019-03-18

## APPLICANT AND AGENT DETAILS

### Applicant

CANADA ROYAL MILK ULC  
1680 Venture Drive  
Kingston  
ONTARIO  
K7P0E9

### Agent

BENNETT JONES LLP  
4500 BANKERS HALL EAST, 855 - 2ND  
STREET S.W., CALGARY, ALBERTA, T2P4K7

## TRADEMARK DETAILS

### Trademark Type

Design

### Visual Representation



### Foreign Character Translation

The translation provided by the applicant of the word Aelpein is a paraphrase that means, in English, 'Love is our foundation, on which we are committed to sharing our values of life'.

### Foreign Character Transliteration

The transliteration provided by the applicant of the Chinese characters is Aelpein.

### Goods

#### Class 05

(1) Infant formula; Infant milk powder; Infant flour contains milk; Infant food; Nutritional supplements for general health and well-being; Protein powder dietary supplements; Infant

diapers; Casein protein dietary supplements; Vitamin preparations; Dietary fiber as a food additive; Dietary fiber to aid digestion.

**Class 29**

(2) Milk; Milk powder; Milk products; Edible fat and oil; Edible bird's nests; Roasted nuts; Blanched nuts; Processed nuts; Flavoured nuts; Soy milk (mainly milk); Yogurt; Goat milk; Goat yogurt.

**Services****Class 35**

Advertising flyer distribution; Sales demonstration for others; Advertising the services of others through all public communication means; Sales demonstration via the internet for the retail sale of infant formula, infant milk powder, infant flour containing milk, infant food, nutritional supplements, protein dietary supplements, infant diapers, casein protein dietary supplements, vitamin preparations, dietary fiber, milk, milk powder, milk products, edible fats and oil, edible bird's nest, roasted nuts, soy milk (mainly milk), yogurt, goat milk, goat yogurt; Providing commercial and business information in the field of nutrition via a website; Promoting the sale of goods and services of others through an online retail store relating to nutrition, infant foods, milk and milk products, and dietary supplements for general health and well-being; Providing online market for buyer and seller of goods and service; Providing advice and information relating to commercial business management.

**Application Number** 1,952,049  
**Language of Application** English

**Filing Date** 2019-03-18

## APPLICANT AND AGENT DETAILS

### Applicant

Organika Health Products Inc.  
13480 Verdun Place  
Richmond  
BRITISH COLUMBIA  
V6V1V2

### Agent

COASTAL TRADEMARK SERVICES LIMITED  
301-543 Granville Street, Vancouver, BRITISH  
COLUMBIA, V6C1X8

## TRADEMARK DETAILS

# ORGANIKA ENHANCED COLLAGEN KETO

### Trademark Type

Standard Characters

### Goods

#### Class 05

dietary supplements to support joint health, joint care and flexibility, and to improve complexity of the skin; nutritional supplements in capsule, tablet, powder and liquid form used for healthy aging

**Application Number** 1,952,511  
**Language of Application** English

**Filing Date** 2019-03-20

## **APPLICANT AND AGENT DETAILS**

### **Applicant**

Williams-Sonoma, Inc.  
3250 Van Ness Avenue  
San Francisco, CA 94109  
UNITED STATES OF AMERICA

### **Agent**

SMART & BIGGAR LP  
SUITE 900, 55 METCALFE STREET, P.O.  
BOX 2999, STATION D, OTTAWA, ONTARIO,  
K1P5Y6

## **TRADEMARK DETAILS**

**Trademark Type**

Design

**Visual Representation**



# **THE ONE**

## **REGISTRY COLLECTIVE**

**Goods**

**Class 09**

Downloadable software in the nature of a mobile application that enables users to create, edit, organize, view, share and manage online gift registries, gift request lists and wish lists, and that allows users to purchase gifts from online gift registries, gift request lists and wish lists

## **Services**

### **Class 35**

(1) Gift registry services; gift registry services offered in connection with retail store services, on-line retail store services, and catalog mail order services featuring house wares, home accessories and products, kitchenware, tableware, cookware, food and beverage items, books, furniture, rugs, lighting, decorative accessories and products, bedding, linens, bath accessories and products, children's furniture, clothing and products, and window coverings

### **Class 42**

(2) Providing a website platform featuring technology that enables users to create, edit, organize, view, share and manage online gift registries, gift request lists and wish lists, and that allows users to purchase gifts from online gift registries, gift request lists and wish lists; platform as a service (PAAS) services featuring non-downloadable software that enables users to create, edit, organize, view, share and manage online gift registries, gift request lists and wish lists, and that allows users to purchase gifts from online gift registries, gift request lists and wish lists

## **Claims**

Priority Filing Date: September 28, 2018, Country or Office: UNITED STATES OF AMERICA, Application No: 88/136,689 in association with the same kind of goods and in association with the same kind of services

**Application Number** 1,953,093  
**Language of Application** English

**Filing Date** 2019-03-22

## APPLICANT AND AGENT DETAILS

### Applicant

REITMANS (CANADA) LIMITED/REITMANS  
(CANADA) LIMITÉE  
250 Sauvé Street West  
Montréal  
QUEBEC  
H3L1Z2

### Agent

KATHERINE R. BRITT  
Reitmans Canada Ltd., 250 rue Sauvé Ouest,  
Montréal, QUEBEC, H3L1Z2

## TRADEMARK DETAILS

# Simplifié, (re)défini, pour chaque moment.

### Trademark Type

Word

### Goods

#### Class 14

(1) Costume jewelry

#### Class 18

(2) Bags namely, shopping bags, shoe bags, knapsacks, sport bags, tote bags

#### Class 25

(3) Casual clothing; Dress clothing; Business clothing

(4) Sleepwear; Nightwear; Socks; Underwear; Swimwear; Headwear namely, hats, headbands, tuques, caps and berets; Scarves; Footwear namely, shoes, thongs, slippers, sandals and running shoes

### Services

#### Class 35

(1) Online and retail sales of casual clothing, dress clothing, business clothing

(2) Online and retail sales of sleepwear, nightwear, socks, underwear, swimwear, headwear namely, hats, headbands, tuques, caps and berets, scarves, footwear namely, shoes, thongs, slippers, sandals and running shoes, costume jewelry, bags namely, shopping bags, shoe bags, knapsacks, sport bags, tote bags



**Application Number** 1,953,096  
**Language of Application** English

**Filing Date** 2019-03-22

## APPLICANT AND AGENT DETAILS

### Applicant

Hewlett-Packard Development Company, L.P.  
10300 Energy Drive  
Spring, TX 77389  
UNITED STATES OF AMERICA

### Agent

GOWLING WLG (CANADA) LLP  
SUITE 1600, 1 FIRST CANADIAN PLACE, 100  
KING STREET WEST, TORONTO, ONTARIO,  
M5X1G5

## TRADEMARK DETAILS

# SPROCKET SELECT

### Trademark Type

Word

### Goods

#### Class 09

Computer hardware, namely, printers for portable and handheld digital electronic devices; photo printers; photographic cameras; digital cameras; computer application software for mobile phones, namely, software to enable the printing of photographic images from smartphones and handheld digital electronic devices

**Application Number** 1,953,588  
**Language of Application** English

**Filing Date** 2019-03-26

## APPLICANT AND AGENT DETAILS

### Applicant

Organic 3, Inc.  
13116 Talbot Avenue  
Huntington Woods, MI 48070  
UNITED STATES OF AMERICA

### Agent

RIDOUT & MAYBEE LLP  
250 University Avenue, 5th Floor, Toronto,  
ONTARIO, M5H3E5

## TRADEMARK DETAILS

# ORGANIC 3

### Trademark Type

Standard Characters

### Goods

#### Class 05

Organic dietary and digestive supplements, namely, HCl and pepsin supplements, nutritional supplements for general health and wellbeing, nutritional yeast, saccharomyces boulardii, mineral supplements, amino acid supplements, enzymes for general health and wellbeing, probiotics, prebiotics, magnesium supplements, boron supplements, zinc supplements, and oyster supplements

### Claims

Priority Filing Date: October 05, 2018, Country or Office: UNITED STATES OF AMERICA,  
Application No: 88/144,715 in association with the same kind of goods

**Application Number** 1,955,579  
**Language of Application** French

**Filing Date** 2019-04-04

## APPLICANT AND AGENT DETAILS

### Applicant

Solution Nexam Inc.  
1043-937 Avenue Roland-Beaudin  
Québec  
QUÉBEC  
G1V0H6

### Agent

ROBIC  
630, boul. René-Lévesque Ouest, 20e étage,  
Montréal, QUÉBEC, H3B1S6

## TRADEMARK DETAILS

# NEXAM

### Trademark Type

Standard Characters

### Goods

#### Class 09

Software, namely software providing access to digital and interactive educational practice tests in the field of business, software enabling the compilation of statistics for the analysis of digital and interactive educational practice test scores and data in the field of business, software enabling the automated grading of digital and interactive practice tests in the field of business and providing automated feedback on digital and interactive educational practice tests.

### Services

#### Class 41

Preparation of custom educational tests in the field of business; analysis of educational test scores and data for others; organization and conduct of e-learning in the field of business; educational support services via telephone, as well as audio and video conference in the field of business.

**Application Number** 1,955,641  
**Language of Application** English

**Filing Date** 2019-04-04

## APPLICANT AND AGENT DETAILS

### Applicant

Truss Limited Partnership  
c/o Gowling WLG (Canada) LLP 1 First  
Canadian Place  
100 King Street West, Suite 1600  
Toronto  
ONTARIO  
M5X1G5

### Agent

JOANNE B. NARDI  
Joanne Nardi IP Consulting Services Inc., 117  
Shadow Falls Drive, Richmond Hill, ONTARIO,  
L4E4K2

## TRADEMARK DETAILS

# DAILY SODA

### Trademark Type

Word

### Goods

#### Class 32

beer-flavoured beverage infused with cannabis; bottled water containing cannabis; bottled water containing derivatives of cannabis; carbonated soft drinks infused with cannabis oil; cider flavoured beverages infused with cannabis; flavored waters containing cannabis; flavored waters containing derivatives of cannabis; fruit beverages and fruit juices containing cannabis; fruit beverages and fruit juices containing derivatives of cannabis; fruit beverages containing derivatives of cannabis; fruit drinks and juices infused with cannabis oil; fruit juices containing derivatives of cannabis; fruit-based beverages containing cannabis; fruit-based beverages containing derivatives of cannabis; fruit-flavoured beverages infused with cannabis; honey-based beverages infused with cannabis; iced fruit beverages infused with cannabis oil; mineral and aerated waters containing cannabis; mineral and aerated waters containing derivatives of cannabis; non alcoholic beer; sports drinks containing cannabis; sports drinks containing derivatives of cannabis;

**Application Number** 1,955,642  
**Language of Application** English

**Filing Date** 2019-04-04

## APPLICANT AND AGENT DETAILS

### Applicant

Truss Limited Partnership  
c/o Gowling WLG (Canada) LLP 1 First  
Canadian Place  
100 King Street West, Suite 1600  
Toronto  
ONTARIO  
M5X1G5

### Agent

JOANNE B. NARDI  
Joanne Nardi IP Consulting Services Inc., 117  
Shadow Falls Drive, Richmond Hill, ONTARIO,  
L4E4K2

## TRADEMARK DETAILS

# DAILY SODA

### Trademark Type

Word

### Goods

#### Class 30

(1) coffee-based beverages containing cannabis; coffee-based beverages containing derivatives of cannabis; tea-based beverages containing cannabis; tea-based beverages containing derivatives of cannabis;

#### Class 32

(2) bottled water containing cannabis; bottled water containing derivatives of cannabis; carbonated beverages infused with cannabis; carbonated soft drinks containing derivatives of cannabis; carbonated soft drinks infused with cannabis oil; cider flavoured beverages infused with cannabis; flavored waters containing cannabis; flavored waters containing derivatives of cannabis; fruit beverages and fruit juices containing cannabis; fruit beverages and fruit juices containing derivatives of cannabis; fruit beverages containing derivatives of cannabis; fruit drinks and juices infused with cannabis oil; fruit juices containing derivatives of cannabis; fruit-based beverages containing cannabis; fruit-based beverages containing derivatives of cannabis; fruit-flavoured beverages infused with cannabis; honey-based beverages infused with cannabis; iced fruit beverages infused with cannabis oil; mineral and aerated waters containing cannabis; mineral and aerated waters containing derivatives of cannabis; smoothies containing cannabis; smoothies containing derivatives of cannabis; sports drinks containing cannabis; sports drinks containing derivatives of cannabis; wine flavoured beverages infused with cannabis; non-alcoholic beer infused with cannabis; non-alcoholic beer flavoured beverage infused with cannabis

**Application Number** 1,956,522  
**Language of Application** French

**Filing Date** 2019-04-10

## APPLICANT AND AGENT DETAILS

### Applicant

L'ORÉAL, Société anonyme  
14 rue Royale  
75008 Paris  
FRANCE

### Agent

FASKEN MARTINEAU DUMOULIN LLP  
Tour de la Bourse, Suite 3500, P.O. box 242,  
800, Place Victoria, Montréal, QUÉBEC,  
H4Z1E9

## TRADEMARK DETAILS

# SCALP-DOSE

### Trademark Type

Word

### Goods

#### Class 03

Cosmetic products for the hair, namely shampoos, gels, mousses, balms, creams, powders, oils, waxes, serums, lotions, masks; preparations in aerosol form for hairstyling and hair care, hair lacquers, colourants and preparations for hair bleaching, preparations for hair colour protection, products for curling and setting the hair, hair straightening preparations.

### Claims

Priority Filing Date: November 15, 2018, Country or Office: FRANCE, Application No: 4500243 in association with the same kind of goods

**Application Number** 1,957,547  
**Language of Application** English

**Filing Date** 2019-04-16

## APPLICANT AND AGENT DETAILS

### Applicant

The Hive Strategic Marketing Inc.  
544 King Street West  
Toronto  
ONTARIO  
M5V1M3

### Agent

RIDOUT & MAYBEE LLP  
250 University Avenue, 5th Floor, Toronto,  
ONTARIO, M5H3E5

## TRADEMARK DETAILS

# VALUABLE ENCOUNTERS

### Trademark Type

Word

### Services

#### Class 35

(1) Advertising agency services; advertising for others and conceiving, preparing, directing and carrying out advertising campaigns for others; advertising of goods and services of others via local and global computer networks; advertising planning for others; advertising the goods and services of others; arranging and conducting advertising campaigns for the products and services of others; consulting in the field of arranging and conducting advertising campaigns for the products and services of others; digital and online advertising of the goods and services of others; direct mail advertising of the goods and services of others; organization of exhibitions for commercial and advertising purposes of a variety of goods for others; preparation and realization of media advertising for others being direct mail; preparing advertisements for others; providing advice in the field of market research and analysis of consumer buying habits and consumer opinions for use in advertising the goods and services of others; brand concept and brand development services for corporate clients; production of advertising messages for radio, television and the internet and social media; promoting the goods and services of others by arranging for sponsors to affiliate their goods and services with sports competitions; copywriting; promoting the sale of goods and services of others through promotional contests provided over the internet; promoting the sale of goods and services through promotional contests and the distribution of related printed material; disseminating samples; merchandising display services conducted by mobile marketing teams, namely in-store, in-restaurant and in-bar marketing services regarding retail merchandising displays, to promote and improve the sale and branding of the goods and services of others; administration of a customer incentive program by setting goals, monitoring progress and providing rewards, discounts and rebates; sales and promotional incentive schemes and promotional services, namely provision of bonus incentive rewards to customers; sales and promotional incentive schemes and promotional services, namely provision of bonus incentive rewards to motivate and educate sales staff, distributors, wholesalers, retailers and consumers; analysis of market research data and statistics; social media strategy consulting.

#### Class 41

(2) Arranging and conducting business conferences; entertainment in the form of personal appearances by a sports celebrity, musical celebrity, or movie star.

**Class 42**

(3) Brand design for others; commercial art design; packaging design; graphic design services.



**Application Number** 1,958,179  
**Language of Application** French

**Filing Date** 2019-04-18

## **APPLICANT DETAILS**

**Applicant**  
IGLOO4TRAVEL INC.  
2118 rue Saint-Germain  
Montréal  
QUÉBEC  
H1W2T7

## **TRADEMARK DETAILS**

**Trademark Type**  
Design

**Visual Representation**



**Goods****Class 10**

(1) Coussins orthopédiques; oreillers orthopédiques pour le support de la nuque; coussins à usage médical; oreillers à usage médical.

**Class 20**

(2) Trousse de voyage pour le sommeil comprenant principalement un oreiller de voyage conçu pour supporter le poids de la tête, un coussin de soutien lombaire, un sac pour transporter l'oreiller et le coussin et pouvant être utilisé pour supporter les bras en position assise, ainsi qu'un sac de compression pour comprimer et transporter les éléments de la trousse; oreillers cervicaux; coussins pour le support de la nuque; oreillers pour le support de la nuque; coussins de maintien dorsal à usage autre que médical; coussins; oreillers; coussins de soutien lombaire.

**Application Number** 1,959,088  
**Language of Application** English

**Filing Date** 2019-04-24

## APPLICANT AND AGENT DETAILS

### Applicant

PAVMED INC.  
One Grand Central Place  
Suite 4600  
New York, NY 10165  
UNITED STATES OF AMERICA

### Agent

CASSELS BROCK & BLACKWELL LLP  
SCOTIA PLAZA, SUITE 2100, 40 KING  
STREET WEST, TORONTO, ONTARIO,  
M5H3C2

## TRADEMARK DETAILS

# ESOGUARD

### Trademark Type

Standard Characters

### Goods

#### Class 10

Medical instruments, devices and apparatus device, namely, DNA and genetic testing kits, for use in diagnostic testing of the gastrointestinal tract and diagnosis of conditions of the gastrointestinal tract

### Services

#### Class 44

Diagnostic services in the fields of medicine related to the gastrointestinal tract; DNA and Genetic testing for the diagnosis of conditions of the gastrointestinal tract; Medical diagnostic testing and reporting services for conditions of the gastrointestinal tract; Collection of human cell and tissue samples for the diagnosis of conditions of the gastrointestinal tract.

### Claims

Priority Filing Date: March 19, 2019, Country or Office: UNITED STATES OF AMERICA,  
Application No: 88347269 in association with the same kind of goods and in association with the same kind of services

**Application Number** 1,959,531  
**Language of Application** English

**Filing Date** 2019-04-26

## APPLICANT AND AGENT DETAILS

### Applicant

Reckitt Benckiser (Canada) Inc.  
1680 Tech Avenue, Unit 2  
Mississauga  
ONTARIO  
L4W5S9

### Agent

SMART & BIGGAR LP  
SUITE 900, 55 METCALFE STREET, P.O.  
BOX 2999, STATION D, OTTAWA, ONTARIO,  
K1P5Y6

## TRADEMARK DETAILS

# LYSOL

### Trademark Type

Word

### Goods

#### Class 03

laundry detergents; all-purpose stain removers for household use, fabric stain removers and laundry stain removers; all-purpose cleaners for washing machines

**Application Number** 1,960,848  
**Language of Application** English

**Filing Date** 2019-05-03

## APPLICANT AND AGENT DETAILS

### Applicant

Toca Boca AB  
Lumaparksvägen 13A  
Stockholm, 120 31  
SWEDEN

### Agent

SPIN MASTER LTD.  
225 King Street West, Suite 200, Toronto,  
ONTARIO, M5V3M2

## TRADEMARK DETAILS

# TOCA LIFE

### Trademark Type

Word

### Goods

#### Class 18

(1) Bags, namely, handbags and purses, backpacks, book bags, tote bags, duffel bags, beach bags, athletic bags, luggage, all for use by children; beach umbrellas.

#### Class 25

(2) Clothing, namely, T-shirts, pants, coats, sweaters, skirts, scarfs, shirts, socks, underpants and dresses; footwear, namely, shoes, boots, slippers and sandals; headgear, namely, hats, beanies and caps; sleepwear; pajamas; headbands; swimwear; gloves; Halloween costumes.

#### Class 28

(3) Games, namely, board games, card games, action skill games; playthings, namely, soft sculpture toys, teddy bears, action figures, toy cars, toy trains, toy kitchens, toy kitchen utensils, and other toys for kids, namely, stuffed toys, plush toys, plastic and vinyl toy characters and toy animals, toy figures and collectable toy figures, bathtub toys, inflatable bath toys, construction toys, toy airplanes and helicopters, articles of clothing for toys, dolls and doll accessories, namely, clothing for dolls, doll rooms, doll beds, doll houses, toy fabrics and linens for dolls and strollers for dolls; home video game machines; hand-held video game machines, namely, hand-held games with liquid crystal displays; electronic educational game machines for children; equipment sold as a unit for playing card games; hand-held game units for playing electronic games for use with external display screen and monitor; game equipment sold as a unit for playing board games and card games; stand-alone video output games machines; electronic amusement apparatus, namely, amusement game machines; sports balls; target games; bubble making wand and solution sets; children's multiple activity toys; costume masks; game apparatus, namely, bases, bats, and balls for playing indoor and outdoor games.

**Application Number** 1,961,364  
**Language of Application** English

**Filing Date** 2019-05-07

## APPLICANT AND AGENT DETAILS

### Applicant

Truss Limited Partnership  
c/o Gowling WLG (Canada) LLP 1 First  
Canadian Place  
100 King Street West, Suite 1600  
Toronto  
ONTARIO  
M5X1G5

### Agent

JOANNE B. NARDI  
Joanne Nardi IP Consulting Services Inc., 117  
Shadow Falls Drive, Richmond Hill, ONTARIO,  
L4E4K2

## TRADEMARK DETAILS

# DAILY-SODA

### Trademark Type

Word

### Goods

#### Class 32

beer-flavoured beverage infused with cannabis; bottled water containing cannabis; bottled water containing derivatives of cannabis; carbonated soft drinks infused with cannabis oil; cider flavoured beverages infused with cannabis; flavored waters containing cannabis; flavored waters containing derivatives of cannabis; fruit beverages and fruit juices containing cannabis; fruit beverages and fruit juices containing derivatives of cannabis; fruit beverages containing derivatives of cannabis; fruit drinks and juices infused with cannabis oil; fruit juices containing derivatives of cannabis; fruit-based beverages containing cannabis; fruit-based beverages containing derivatives of cannabis; fruit-flavoured beverages infused with cannabis; honey-based beverages infused with cannabis; iced fruit beverages infused with cannabis oil; mineral and aerated waters containing cannabis; mineral and aerated waters containing derivatives of cannabis; sports drinks containing cannabis; sports drinks containing derivatives of cannabis;

**Application Number** 1,961,365  
**Language of Application** English

**Filing Date** 2019-05-07

## APPLICANT AND AGENT DETAILS

### Applicant

Truss Limited Partnership  
c/o Gowling WLG (Canada) LLP 1 First  
Canadian Place  
100 King Street West, Suite 1600  
Toronto  
ONTARIO  
M5X1G5

### Agent

JOANNE B. NARDI  
Joanne Nardi IP Consulting Services Inc., 117  
Shadow Falls Drive, Richmond Hill, ONTARIO,  
L4E4K2

## TRADEMARK DETAILS

# DAILY-SODA

### Trademark Type

Word

### Goods

#### Class 30

(1) coffee-based beverages containing cannabis; coffee-based beverages containing derivatives of cannabis; tea-based beverages containing cannabis; tea-based beverages containing derivatives of cannabis;

#### Class 32

(2) bottled water containing cannabis; bottled water containing derivatives of cannabis; carbonated beverages infused with cannabis; carbonated soft drinks containing derivatives of cannabis; carbonated soft drinks infused with cannabis oil; cider flavoured beverages infused with cannabis; flavored waters containing cannabis; flavored waters containing derivatives of cannabis; fruit beverages and fruit juices containing cannabis; fruit beverages and fruit juices containing derivatives of cannabis; fruit beverages containing derivatives of cannabis; fruit drinks and juices infused with cannabis oil; fruit juices containing derivatives of cannabis; fruit-based beverages containing cannabis; fruit-based beverages containing derivatives of cannabis; fruit-flavoured beverages infused with cannabis; honey-based beverages infused with cannabis; iced fruit beverages infused with cannabis oil; mineral and aerated waters containing cannabis; mineral and aerated waters containing derivatives of cannabis; smoothies containing cannabis; smoothies containing derivatives of cannabis; sports drinks containing cannabis; sports drinks containing derivatives of cannabis; wine flavoured beverages infused with cannabis; non-alcoholic beer infused with cannabis; non-alcoholic beer-flavoured beverage infused with cannabis

**Application Number** 1,961,366  
**Language of Application** English

**Filing Date** 2019-05-07

## APPLICANT AND AGENT DETAILS

### Applicant

Truss Limited Partnership  
c/o Gowling WLG (Canada) LLP 1 First  
Canadian Place  
100 King Street West, Suite 1600  
Toronto  
ONTARIO  
M5X1G5

### Agent

JOANNE B. NARDI  
Joanne Nardi IP Consulting Services Inc., 117  
Shadow Falls Drive, Richmond Hill, ONTARIO,  
L4E4K2

## TRADEMARK DETAILS

### Trademark Type

Design

### Visual Representation

**DAILY-**  
**SODA**

### Goods

#### Class 32

beer-flavoured beverage infused with cannabis; bottled water containing cannabis; bottled water containing derivatives of cannabis; carbonated soft drinks infused with cannabis oil; cider flavoured beverages infused with cannabis; flavored waters containing cannabis; flavored waters containing derivatives of cannabis; fruit beverages and fruit juices containing cannabis; fruit beverages and



fruit juices containing derivatives of cannabis; fruit beverages containing derivatives of cannabis; fruit drinks and juices infused with cannabis oil; fruit juices containing derivatives of cannabis; fruit-based beverages containing cannabis; fruit-based beverages containing derivatives of cannabis; fruit-flavoured beverages infused with cannabis; honey-based beverages infused with cannabis; iced fruit beverages infused with cannabis oil; mineral and aerated waters containing cannabis; mineral and aerated waters containing derivatives of cannabis; sports drinks containing cannabis; sports drinks containing derivatives of cannabis;

**Application Number** 1,961,367  
**Language of Application** English

**Filing Date** 2019-05-07

## APPLICANT AND AGENT DETAILS

### Applicant

Truss Limited Partnership  
c/o Gowling WLG (Canada) LLP 1 First  
Canadian Place  
100 King Street West, Suite 1600  
Toronto  
ONTARIO  
M5X1G5

### Agent

JOANNE B. NARDI  
Joanne Nardi IP Consulting Services Inc., 117  
Shadow Falls Drive, Richmond Hill, ONTARIO,  
L4E4K2

## TRADEMARK DETAILS

### Trademark Type

Design

### Visual Representation

**DAILY-**  
**SODA**

### Goods

#### Class 30

(1) coffee-based beverages containing cannabis; coffee-based beverages containing derivatives of cannabis; tea-based beverages containing cannabis; tea-based beverages containing derivatives of cannabis;

**Class 32**

(2) bottled water containing cannabis; bottled water containing derivatives of cannabis; carbonated beverages infused with cannabis; carbonated soft drinks containing derivatives of cannabis; carbonated soft drinks infused with cannabis oil; cider flavoured beverages infused with cannabis; flavored waters containing cannabis; flavored waters containing derivatives of cannabis; fruit beverages and fruit juices containing cannabis; fruit beverages and fruit juices containing derivatives of cannabis; fruit beverages containing derivatives of cannabis; fruit drinks and juices infused with cannabis oil; fruit juices containing derivatives of cannabis; fruit-based beverages containing cannabis; fruit-based beverages containing derivatives of cannabis; fruit-flavoured beverages infused with cannabis; honey-based beverages infused with cannabis; iced fruit beverages infused with cannabis oil; mineral and aerated waters containing cannabis; mineral and aerated waters containing derivatives of cannabis; smoothies containing cannabis; smoothies containing derivatives of cannabis; sports drinks containing cannabis; sports drinks containing derivatives of cannabis; wine flavoured beverages infused with cannabis; non-alcoholic beer infused with cannabis; non-alcoholic beer-flavoured beverage infused with cannabis

**Application Number** 1,961,368  
**Language of Application** English

**Filing Date** 2019-05-07

## **APPLICANT AND AGENT DETAILS**

### **Applicant**

Truss Limited Partnership  
c/o Gowling WLG (Canada) LLP 1 First  
Canadian Place  
100 King Street West, Suite 1600  
Toronto  
ONTARIO  
M5X1G5

### **Agent**

JOANNE B. NARDI  
Joanne Nardi IP Consulting Services Inc., 117  
Shadow Falls Drive, Richmond Hill, ONTARIO,  
L4E4K2

## **TRADEMARK DETAILS**

### **Trademark Type**

Design

### **Visual Representation**

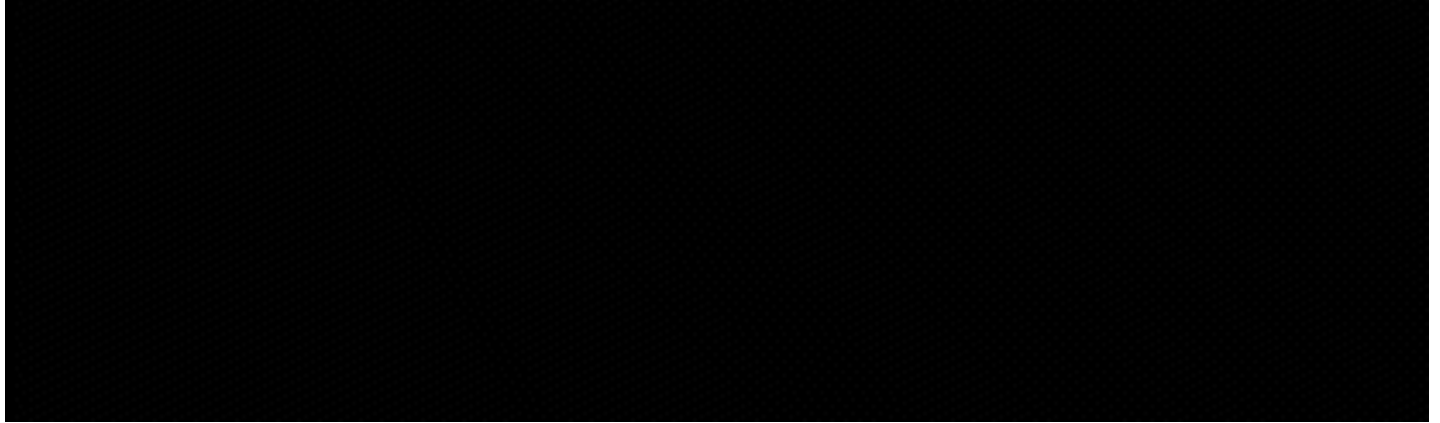

**DAILY-**  
**SODA**

**Goods****Class 32**

beer-flavoured beverage infused with cannabis; bottled water containing cannabis; bottled water containing derivatives of cannabis; carbonated soft drinks infused with cannabis oil; cider flavoured beverages infused with cannabis; flavored waters containing cannabis; flavored waters containing derivatives of cannabis; fruit beverages and fruit juices containing cannabis; fruit beverages and fruit juices containing derivatives of cannabis; fruit beverages containing derivatives of cannabis; fruit drinks and juices infused with cannabis oil; fruit juices containing derivatives of cannabis; fruit-based beverages containing cannabis; fruit-based beverages containing derivatives of cannabis; fruit-flavoured beverages infused with cannabis; honey-based beverages infused with cannabis; iced fruit beverages infused with cannabis oil; mineral and aerated waters containing cannabis; mineral and aerated waters containing derivatives of cannabis; sports drinks containing cannabis; sports drinks containing derivatives of cannabis;

**Application Number** 1,961,369  
**Language of Application** English

**Filing Date** 2019-05-07

## APPLICANT AND AGENT DETAILS

### Applicant

Truss Limited Partnership  
c/o Gowling WLG (Canada) LLP 1 First  
Canadian Place  
100 King Street West, Suite 1600  
Toronto  
ONTARIO  
M5X1G5

### Agent

JOANNE B. NARDI  
Joanne Nardi IP Consulting Services Inc., 117  
Shadow Falls Drive, Richmond Hill, ONTARIO,  
L4E4K2

## TRADEMARK DETAILS

### Trademark Type

Design

### Visual Representation

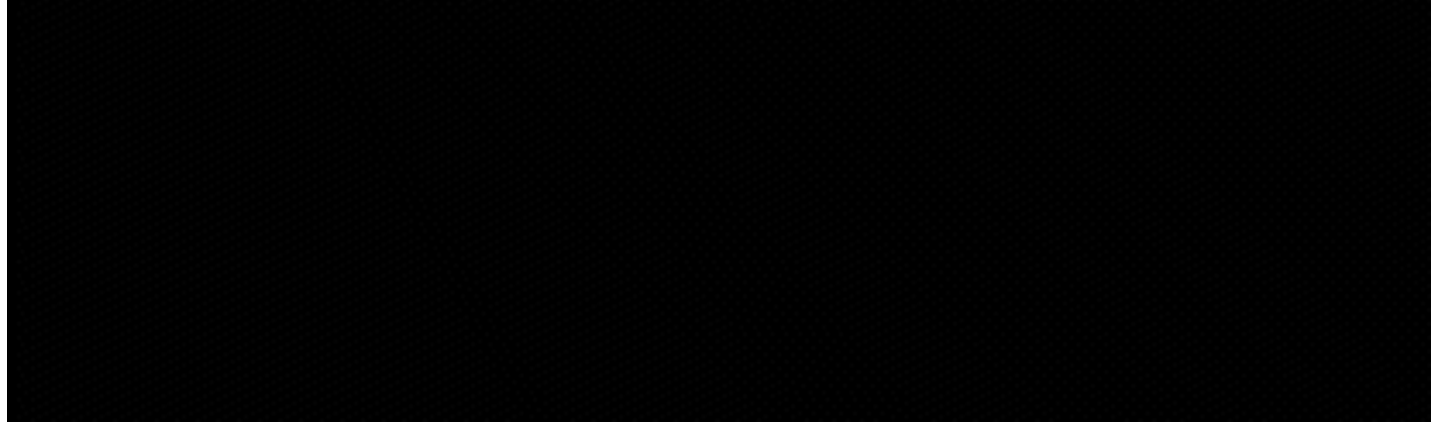

**DAILY-**  
**SODA**

**Goods****Class 30**

(1) coffee-based beverages containing cannabis; coffee-based beverages containing derivatives of cannabis; tea-based beverages containing cannabis; tea-based beverages containing derivatives of cannabis;

**Class 32**

(2) bottled water containing cannabis; bottled water containing derivatives of cannabis; carbonated beverages infused with cannabis; carbonated soft drinks containing derivatives of cannabis; carbonated soft drinks infused with cannabis oil; cider flavoured beverages infused with cannabis; flavored waters containing cannabis; flavored waters containing derivatives of cannabis; fruit beverages and fruit juices containing cannabis; fruit beverages and fruit juices containing derivatives of cannabis; fruit beverages containing derivatives of cannabis; fruit drinks and juices infused with cannabis oil; fruit juices containing derivatives of cannabis; fruit-based beverages containing cannabis; fruit-based beverages containing derivatives of cannabis; fruit-flavoured beverages infused with cannabis; honey-based beverages infused with cannabis; iced fruit beverages infused with cannabis oil; mineral and aerated waters containing cannabis; mineral and aerated waters containing derivatives of cannabis; smoothies containing cannabis; smoothies containing derivatives of cannabis; sports drinks containing cannabis; sports drinks containing derivatives of cannabis; wine flavoured beverages infused with cannabis; non-alcoholic beer infused with cannabis; non-alcoholic beer-flavoured beverage infused with cannabis

**Application Number** 1,961,950  
**Language of Application** English

**Filing Date** 2019-05-09

## APPLICANT AND AGENT DETAILS

### Applicant

BAYER INTELLECTUAL PROPERTY GMBH  
Alfred-Nobel-Str. 10  
40789 Monheim am Rhein  
GERMANY

### Agent

GOWLING WLG (CANADA) LLP  
SUITE 2600, 160 ELGIN STREET, OTTAWA,  
ONTARIO, K1P1C3

## TRADEMARK DETAILS

# GET BACK TO YOU

### Trademark Type

Standard Characters

### Goods

#### Class 05

antifungal pharmaceutical preparations; medicated antibacterial gels, skin soaps and sprays;



**Application Number** 1,962,021  
**Language of Application** English

**Filing Date** 2019-05-09

## APPLICANT AND AGENT DETAILS

### Applicant

Turner Network Television, Inc.  
1050 Techwood Drive  
Atlanta, GA 30318  
UNITED STATES OF AMERICA

### Agent

SMART & BIGGAR LP  
1100-150 York street, TORONTO, ONTARIO,  
M5H3S5

## TRADEMARK DETAILS

# RAISED BY WOLVES

### Trademark Type

Word

### Goods

#### Class 09

Pre-recorded audio and visual recordings, namely, downloadable audiovisual recordings in all media, featuring entertainment in the nature of an on-going television series in the field of comedy, action, drama and adventure; pre-recorded audio and visual recordings, namely, optical discs, CD-ROMS, DVDs, discs bearing audiovisual video recordings, featuring entertainment in the nature of an on-going television series in the field of comedy, action, drama and adventure; downloadable television programming featuring comedy, action, drama and adventure distributed via the Internet and wireless communications

### Services

#### Class 41

Entertainment services, namely, a multimedia television program series featuring comedy, action, drama, science-fiction and adventure distributed via various platforms across multiple forms of transmission media

**Application Number** 1,962,624  
**Language of Application** English

**Filing Date** 2019-05-13

## APPLICANT DETAILS

### Applicant

Douglas Macdonald  
1757 Phillbrook Ct  
London  
ONTARIO  
N5X2Z2

## TRADEMARK DETAILS

# Investher

### Trademark Type

Word

### Services

#### Class 36

brokerage services for capital investments; estate planning; estate trust planning; financial analyses; financial analysis; financial asset management; financial investment analysis and stock research; financial investment brokerage; financial investment counselling; financial investment in the field of securities; financial investments in the field of commodities; financial investments in the field of gold; financial investments in the field of mutual funds; financial investments in the field of securities; financial management; financial planning; investment management; investment of funds; investment risk assessment services; mutual funds and capital investment; private equity fund investment services

**Application Number** 1,962,902  
**Language of Application** English

**Filing Date** 2019-05-14

## APPLICANT AND AGENT DETAILS

### Applicant

Parsons Xtreme Golf, LLC  
15475 N. 84th St.  
Scottsdale, AZ 85260  
UNITED STATES OF AMERICA

### Agent

GOWLING WLG (CANADA) LLP  
SUITE 1600, 1 FIRST CANADIAN PLACE, 100  
KING STREET WEST, TORONTO, ONTARIO,  
M5X1G5

## TRADEMARK DETAILS

# NOBODY MAKES GOLF CLUBS THE WAY WE DO. PERIOD.

### Trademark Type

Word

### Services

#### Class 35

Retail store services and on-line retail store services in the field of golf equipment, clothing, eyewear, footwear, headwear, bags of all kinds, umbrellas, accessories made of leather and imitations of leather being belts, scarves, gloves, luggage tags, cell phone cases, card cases; providing on-line consumer product information in the field of the retail of golf-related products and the sport of golf

**Application Number** 1,963,855  
**Language of Application** English

**Filing Date** 2019-05-21

## APPLICANT DETAILS

### Applicant

Ankita Chandaliya  
601, Gayatri Bhawan, 90 feet road  
400101  
P.O. Box 400101  
Mumbai  
INDIA

## TRADEMARK DETAILS

# STELCORE

### Trademark Type

Word

### Services

#### Class 35

(1) account auditing; accountancy; accountancy advice relating to tax preparation; accountancy advice relating to taxation; accountancy advice relating to the preparation of tax returns; accountancy services; accountancy services relating to accounts receivable; accounting; accounting advisory services; accounting consultation; accounting for third parties; accounting services; accounting services for mergers and acquisitions; accounting services relating to tax planning; acquisition and merger consultation; addressing of envelopes; administration of a discount program for enabling participants to obtain discounts on goods and services through use of a discount membership card; administration of business payroll for others; administration of consumer loyalty programs; administration of cultural and educational exchange programs; administration of customer loyalty programs; administration of employee benefit plans concerning fitness club memberships; administration of employee pension plans; administration of frequent flyer programs; administration of frequent flyer programs that allow members to redeem miles for points or awards offered by other loyalty programs; administration of incentive award programmes to promote the sale of the goods and services of others; administration of loyalty rewards programmes featuring trading stamps; administration of pre-paid health care plans; administration of prepaid health care plans; administration of savings accounts; administrative accounting; administrative assistance in responding to calls for tenders; administrative assistance in responding to requests for proposals [RFPs]; administrative hotel management; administrative management of health care clinics; administrative management of hospitals; administrative processing of insurance claims; administrative processing of purchase orders; administrative processing of purchase orders within the framework of services provided by mail-order companies; administrative services in the field of employee stock plans; advertising agencies; advertising agency services; advertising and business management consultancy; advertising by transmission of on-line publicity for third parties through electronic communications networks; advertising copywriting; advertising flyer distribution; advertising flyer distribution for others; advertising on the Internet for others; advertising relating to pharmaceutical products and in-vivo imaging products of others; advertising services for promoting a series of films for others; advertising services for

promoting public awareness of environmental issues and initiatives; advertising services for promoting public awareness of the benefits of physical activity; advertising services for promoting public awareness of the need for organ and tissue donation; advertising services for promoting the brokerage of stocks and other securities for others; advertising services of a radio and television advertising agency; advertising text publication services for others; advertising the goods and services of others; advertising the goods and services of others in periodicals, brochures and newspapers; advertising the goods and services of others in the popular and professional press; advertising the goods and services of others through all public communication means; advertising the goods and services of others via electronic media and specifically the internet; advice and information about customer services and product management and prices on Internet sites in connection with purchases made over the Internet; advice and information concerning commercial business management; advice concerning chemical product marketing; advice in the field of business management and marketing; advice in the running of establishments as franchises; advice relating to the organisation and management of business; advisory and consultancy services in the field of export, export services, export promotion information and services; advisory services for business management; advisory services relating to business management; advisory services relating to business management and business operations; airport management; alcoholic beverage procurement services for others; analysis of market research data and statistics; arranging and conducting automobile trade show exhibitions; arranging and conducting book trade fairs; arranging and conducting craft trade show exhibitions; arranging and conducting fitness equipment trade show exhibitions; arranging and conducting of auction sales; arranging and conducting toy trade show exhibitions; arranging newspaper subscriptions for others; arranging of subscriptions for the publications of others; arranging subscriptions of the online publications of others; arranging subscriptions to newspapers for others; arranging subscriptions to online publications for others; art galleries; assessment and evaluation of taxes; Assistance, advisory services and consultancy with regard to business organization; association services for promoting the interests of nurses; association services for promoting the interests of teachers; association services for promoting the interests of truckers; attorney referrals; auction services; auctioneering; auctioneering of property; auctioneering provided on the internet; auctioning of vehicles; auctioning via telecommunication networks; audience rating determination for radio and television broadcasts; auditing of financial statements; auditing utility rates for others; automobile dealerships; bakery shops; bartering of goods for others; beverage concession stands; billing services; boat dealerships; book-keeping; bookkeeping services; business acquisition and merger consultation; business acquisitions consultation; business acquisitions consulting; business administration and management; business administration assistance; business administration consultancy; business administration consulting services; business administration in the field of transport and delivery; business administration services; business appraisals; business appraisals and evaluations in business matters; business auditing; business consulting in the field of business acquisitions and mergers; business consulting in the field of business networking; business consulting in the field of business relocation; business efficiency expert services; business efficiency services; business feasibility studies; business information services in the field of incorporation and trade-marks; business information services in the field of stock prices; business information services in the field of taxes; business intelligence reporting; business intermediary services relating to the matching of potential private investors with entrepreneurs needing funding; business invoicing services; business management; business management advice; business management advisory services relating to franchising; business management analysis; business management and advice; business management and enterprise organization consultancy; business management and organization consultancy; business management assistance; business management assistance and particularly carrying out tasks necessary for the smooth conduct of

sales by auction; business management assistance for industrial and commercial companies; business management assistance for industrial or commercial companies; business management consultancy; business management consultancy and advisory services; business management consultancy as well as development of processes for the analysis and the implementation of strategy plans and management projects; business management consultancy in the field of transport and delivery; business management consultancy services; business management consultancy via the Internet; business management consultation; business management consulting; business management consulting with relation to strategy, marketing, production, personnel and retail sale matters; business management for a trade company and for a service company; business management for freelance service providers; business management for shops; business management in the field of transport and delivery; business management of hotels; business management of hotels for others; business management of performing artists; business management of reimbursement programmes for others; business management of reimbursement programs for others; business management of sports people; business management planning; business management services; business management services relating to information and data compiling and analyzing; business management supervision; business marketing consulting services; business merchandising display services; business merger consultation; business organisation and management consulting services; business organisation consulting; business organization advice for others; business organization and management consultancy including personnel management; business organization and management consulting; business organization and operation consultancy; business organization consultancy services; business planning; business process re-engineering; business process reengineering services; business project management services for construction projects; business relocation services; business risk assessment services; business risk management services; business services, namely developing fundraising campaigns for others; business strategic planning; business strategic planning services; business strategy development services; business succession planning; butcher shops; buying club services; career placement; career placement consulting services; career planning; carrying out auction sales; catalogue shopping services in the field of automobile parts; catalogue shopping services in the field of clothing; catalogue shopping services in the field of cosmetics; catalogue shopping services in the field of home entertainment electronics; catalogue shopping services in the field of photographic equipment; catalogue shopping services in the field of sporting goods; chamber of commerce services promoting business and tourism in the City of Ottawa; chamber of commerce services promoting business and tourism in the Niagara region; chamber of commerce services promoting business and tourism in the Okanagan Valley; clearinghouse services for radio and television; clerical services; clothing concession stands; collection of market research information; commercial assistance in business management; commercial business management; commercial business management services; commercial information agencies providing tax information; commercial lobbying services; compilation of advertisements for use as web pages on the internet; compilation of business directories; compilation of statistics; compilation, production and dissemination of advertising matter for others; computer database management services; computer file management; computerised database management; computerised file management; computerised market research services; computerized accounting services; computerized business file management; computerized central file management; computerized database management; computerized file management; computerized market research services; computerized on-line gift ordering service which matches the gift giver's requirements with the gift recipient's wants and needs; computerized online ordering featuring clothing; computerized on-line ordering services in the field of cosmetics; computerized word processing; conducting an on-line tradeshow exhibition in the field of jewellery; conducting business and market research surveys for others; conducting employee incentive award programs

to promote on the job safety; conducting employee incentive award programs to promote productivity and quality; conducting market surveys for others; conducting marketing studies; conducting of auction sales; conducting of business feasibility studies; conducting public opinion polls; conducting public opinion surveys; conference call transcription services; consignment sale of art; consignment sale of clothing; consignment sale of jewellery; consignment sale of sporting goods; construction cost management; consultancy and advisory services in the field of business strategy; consultancy of personnel recruitment; consultancy relating to personnel management; consultation in the field of business acquisitions; consulting and information concerning accounting; consulting in the fields of business organization and management; consulting services in business organization and management; consumer research; consumer research services; copying of documents; copying of documents for others; corporate identity services; corporate image development consultation; cost accounting; cost analyses; cost analysis; cost assessment services; cost management in the field of health care; cost price analysis; cost-price analysis; cost /price analysis; coupon procurement services for others; creating and updating advertising material for others; creation of trade-marks for others; credit card registration services; credit card reward program services; customer service in the field of airline reservations; customer service in the field of automobile repair; customer service in the field of computer servicing; database management; database marketing services in the form of compiling customer specific databases; delicatessens; design of marketing surveys; design of public opinion surveys; developing and coordinating volunteer projects for charitable organisations; developing and coordinating volunteer projects for charitable organizations; developing marketing strategies and marketing concepts for others; developing promotional campaigns for business for others; developing promotional campaigns for others; development of hospital management systems; development of marketing strategies and concepts for others; direct mail advertising of the goods and services of others; direct marketing of the goods and services of others; discount clothing stores; discount cosmetics stores; discount photographic equipment stores; discount sporting goods stores; dissemination of advertising for others via an on-line communications network on the internet; dissemination of advertising for others via the Internet; dissemination of advertising matter for others; distribution of advertisements and commercial announcements for others; distribution of advertising mail and of advertising supplements attached to regular editions for others; distribution of advertising materials for others; distribution of automotive parts; distribution of handbills; distribution of products for others for advertising purposes; distribution of samples for publicity purposes; distributorships in the field of automotive parts; distributorships in the field of clothing; distributorships in the field of cosmetics; document copying services; document reproduction; door to door selling of books; door to door selling of cookies; door to door selling of cosmetics; door to door selling of magazines; door to door selling of meat; drawing up of statements of accounts; duplication of library material; economic analysis; economic forecasting; economic forecasting and analysis; electronic billboard advertising of the goods and services of others; employee relocation; employee relocation services; employment agencies; employment agency services; employment agency services relating to au pairs; employment counselling and recruiting; employment management agencies; employment outplacement services; employment recruiting services; employment skills testing; evaluation of employee performances; executive recruiting services; executive search and placement services; export and import agencies; fashion show exhibitions for commercial purposes; financial statement preparation and analysis for businesses; flea markets; florist shop services; food concession stands; foreign trade information and consultation; foreign trade information and consultation services; forestry management; forestry management consulting services; fruit stands; general information clearing house services; gift registry services; goods import-export agencies; handbill distribution; health care cost containment services; home demonstrations selling jewellery; home demonstrations selling lingerie; home demonstrations

selling toys; home jewellery parties; home lingerie parties; hospital administration; hospital management; hotel management; hotel management for others; human resources consultancy; human resources consultation; human resources consulting services; human resources management; human resources outsourcing services; import and export agencies; import-export agencies; import-export agencies in the field of energy; import-export agency services; income tax consulting services; indexing of documents for others; interim business management; inventory control; inventory control services; inventory management in the field of auto parts; inventorying merchandise; invoicing; invoicing services; issuing and updating of advertising texts for others; jewellery concession stands; job and personnel placement; job placement; job placement services; key return registration services; keypunching; labour exchanges; labour unions; layout services for advertising purposes; leasing of advertising space on the Internet for employment advertising; leasing of office equipment; literary agencies; magazine advertising for others; magazine mail order services; mail order book clubs; mail order services in the field of books; mail order services in the field of clothing; mail order services in the field of cosmetics; mail order services in the field of furniture; mail order services in the field of jewellery; mail order services in the field of shoes; mail order services in the field of toys; mail sorting, handling and receiving; mailing list preparation; management and compilation of computerised databases; management and compilation of computerized databases; management and operation assistance to commercial businesses; management of an airline company; management of computerized databases; management of health care clinics for others; management of performing artists; management of professional athletes; market analysis; market analysis and research; market analysis and research services; market analysis and studies; market assessment services; market opinion polling studies; market reports and studies; market research by means of a computer database; market research services; market research studies; market segmentation consultation; market studies; market study and analysis of market studies; marketing analysis services; marketing research; marketing research in the fields of cosmetics, perfumery and beauty products; marketing services in the field of arranging for the distribution of the products of others; marketing services in the field of evaluating markets for existing goods and services of others; media relations services; mediation and conclusion of commercial transactions for others; mediation of advertising for others; mediation of agreements for others for the sale and purchase of goods; mediation of contracts for purchase and sale of products; mediation of trade business for third parties; medical billing; medical cost management; medical transcription services; modeling agencies; modeling services for advertising or sales promotion; modelling agency services; modelling for advertising or sales promotion; negotiation and conclusion of commercial transactions for third parties; negotiation of business contracts for others; news clipping services; newspaper advertising for others; newspaper subscriptions; offering technical assistance in the establishment and operation of bakery shop franchises; offering technical assistance in the establishment and operation of car wash franchises; offering technical assistance in the establishment and operation of clothing store franchises; offering technical assistance in the establishment and operation of restaurant franchises; office machines and equipment rental; office support staff recruitment services; on-line advertising for others on computer networks; online advertising for others via a computer communications network; on-line advertising the goods and services of others on computer communications networks; online art galleries; on-line auction bidding for others; online auction services; on-line auctioneering; online department store services; online retail services for downloadable and pre-recorded music and movies; online retail services for downloadable digital music; online retail services for downloadable ring tones; online sales of arts and crafts; online sales of automobile parts; online sales of body care products; online sales of car audio electronics; online sales of clothing; online sales of cosmetics; online sales of downloadable pre-recorded music; online sales of downloadable ring tones; online sales of food items; online sales of footwear; online sales of



headwear; online sales of home entertainment electronics; online sales of housewares; online sales of lingerie; online sales of photographic equipment; online sales of sporting goods; online sales of toys; on-line trading services in which seller posts products to be auctioned and bidding is done via the Internet; on-line wholesale store services featuring agricultural equipment; on-line wholesale store services featuring animal grooming preparations; on-line wholesale store services featuring audiovisual equipment; online wholesale store services featuring baked goods; online wholesale store services featuring beer; online wholesale store services featuring cocoa; on-line wholesale store services featuring stationery supplies; on-line wholesale store services featuring vehicles; online wholesale store services featuring weapons; operating marketplaces; operation of a book store; operation of a clothing store; operation of a computer database containing job postings; operation of a department store; operation of a furniture store; operation of a telephone switchboard for others; operation of computer equipment store; operation of grocery store; opinion polling; organisation and management of customer loyalty programs; organisation for a third party of telephone welcoming services and of telephone receptionist services; organisation of fashion shows for commercial purposes; organisation of Internet auctions; organization of exhibitions of flowers and plants for commercial or advertising purposes; organization of fashion shows for promotional purposes; organizing and conducting job fairs; outsourcing of insurance services; outsourcing of legal services; outsourcing of payroll services; outsourcing of translation services; outsourcing of web development services; payroll preparation; payroll preparation services; personality testing for business purposes; personality testing for recruitment purposes; personality testing for the selection of personnel; personnel consultancy; personnel management; personnel management and employment consultancy; personnel management assistance services; personnel management consultancy; personnel management consultation; personnel management consulting; personnel placement; personnel placement and recruitment; personnel placement consultancy; personnel recruitment; personnel recruitment and placement; personnel recruitment services and employment agencies; personnel relocation; personnel relocation services; personnel selection using psychological testing; phonetic transcription; photocopying; photocopying services; placement of staff; placing advertisements for others; planning concerning business management, namely, searching for partners for amalgamations and business take-overs as well as for business establishments; political action committee services in the form of promoting the interests of auto workers; political action committee services in the form of promoting the interests of farmers; preparation of business reports; preparation of custom advertisements for others; preparation of financial statements; preparation of wage slips; preparing advertisements for others; preparing and placing advertisements for others; preparing and placing of advertisements for others; preparing and placing outdoor advertisements for others; preparing business reports; preparing income tax reports; preparing mailing lists; press advertising consultancy; press clipping services; price comparison rating of accommodations; price comparison services; printing of advertising matter for others; processing warranty registration documents for others; procurement of contracts for the purchase and sale of goods; procurement of contracts for the purchase and sale of goods and services; procurement services in the form of purchasing computer hardware; procurement services in the form of purchasing heavy equipment; procurement services in the form of purchasing vehicles; procurement services in the form of purchasing weapons; procuring of contracts for the purchase and sale of goods of others; producing promotional videotapes, video discs, and audio visual recordings for others; product demonstration services in shop windows by live models; product demonstrations of kitchen appliances; production of advertising films for others; production of advertising materials for others; production of advertising matter and commercials for others; production of infomercials; production of teleshopping programmes; production of television commercials; professional consultancy relating to personnel management; profit survey and analysis services; promoting goods and

services through the distribution of discount cards; promoting the artwork of others by means of providing online portfolios via a website; promoting the goods and services of others by arranging for sponsors to affiliate their goods and services with soccer competitions; promoting the goods and services of others by preparing and placing advertisements in electronic magazines; promoting the goods and services of others through advertisements on Internet websites; promoting the goods and services of others through infomercials; promoting the goods and services of others through the administration of sales and promotional incentive schemes involving trading stamps; promoting the goods and services of others through the distribution of discount cards; promoting the music of others by means of providing online portfolios via a website; promoting the sale of credit card accounts through the administration of incentive award programs; promoting the sale of goods and services by awarding purchase points for credit card use; promoting the sale of goods and services of others by awarding purchase points for credit card use; promoting the sale of goods and services through a consumer loyalty program; promoting the sale of goods and services through promotional contests and the distribution of related printed material; promotional management for sports personalities; providing a searchable online advertising guide featuring the goods and services of other on-line vendors on the internet; providing administrative assistance to pharmacies for managing drug inventories; providing advertising space in a periodical; providing advertising space in periodicals, newspapers and magazines; providing advice and information relating to commercial business management; providing advice in the field of business efficiency; providing advice in the field of business management and marketing; providing advice relating to the analysis of consumer buying habits; providing an on-line commercial information directory on the internet; providing an online commercial information directory on the Internet; providing and rental of advertising space on the internet; providing and rental of exhibition stands and booths; providing assistance in the field of business management within the framework of a franchise contract; providing business information in the field of social media; providing business management start-up support for other businesses; providing business marketing information for others; providing consumer product information in the field of office computer equipment via a website; providing electronic verification of online orders of digital content; providing employment counseling services; providing focus group services; providing home shopping services of car audio electronics via the Internet; providing home shopping services of cosmetics by means of television; providing home shopping services of fitness equipment via the Internet; providing home shopping services of home entertainment electronics by means of television; providing home shopping services of jewellery by telephone; providing home shopping services of sporting goods via the Internet; providing hotel rate comparison information; providing human resources management and recruitment services for others; providing information in the area of global sustainable business solutions; providing information in the field of time management; providing information relating to employee relocation services; providing market intelligence services; providing marketing consultancy in the field of social media; providing marketing consulting in the field of social media; providing marketing strategies for others; providing on-line auction services; providing online auction services; providing online commercial directory information services; providing on-line downloadable music; providing operational business assistance to enterprises; providing promotional coupon programs pertaining to a line of food products; providing quality management systems auditing; providing tax information via an interactive website; provision of information and advisory services relating to e-commerce; provision of information relating to market studies; provision of market research information; provision of marketing reports; provision of space on websites for advertising goods and services; psychological testing for the selection of personnel; psychometric testing for the selection of personnel; public opinion polling; public opinion surveys; public policy research services; public relations; public relations consultancy; public relations services; public utilities cost

management; publication of publicity texts; publicity agencies; publicity agency services; publicity agents; publicity bureau services; purchasing agents; rating of accommodations services; real estate sales management services; recruitment of flight personnel, technical ground staff and non-technical ground staff; recruitment of high-level management personnel; relocation services for business; relocation services for businesses; rental of advertising space; rental of advertising space on web sites; rental of office equipment in co-working facilities; rental of office machinery and equipment; rental of photocopiers; rental of photocopying machines; rental of sales stands; rental of typewriters and copying machines; rental of vending machines; renting of advertising spaces; restaurant management for others; resumé preparation services; resumé preparation services; retail book store services; retail clothing store services; retail computer equipment store services; retail convenience store services; retail department store services; retail furniture store services; retail grocery store services; retail sale of audio equipment; retail sale of automobile parts; retail sale of clothing; retail sale of computer software; retail sale of cosmetics; retail sale of food; retail sale of jewellery; retail sale of lingerie; retail sale of photographic equipment; retail sale of sporting goods; retail sale of toys; retail services for alcoholic beverages; retail services for chemicals for use in agriculture; retail services for computer hardware; retail services for computer software; retail services for jewellery; retail services for navigation devices; retail services for pharmaceutical, veterinary and sanitary preparations and medical supplies; retail services for works of art provided by art galleries; retail services in relation to litter for animals; retail services in relation to non-alcoholic drinks; retail services in relation to works of art; retail services provided by bakery shops; retail services provided by butcher shops; retail services provided by candy stores; retail services provided by clothing boutiques; retail services provided by consignment stores; retail services provided by convenience stores; retail services provided by hypermarkets; retail services provided by lawn, garden and nursery stores; retail services provided by music and record stores; retail services provided by music stores; retail services provided by record stores; retail services provided by television stores; retail services provided by tobacco shops; retail services relating to automobile accessories; retail services relating to automobile parts; retail services relating to candy; retail services relating to delicatessen products; retail services relating to fake furs; retail services relating to ice cream; retail shop window display arrangement services; retail store reward programs; retail store services featuring clothing; sale of cars; sale of clothing; sale of computer software; sale of customized gift baskets; sale of flowers; sale of motor vehicles; sales demonstration for others; sales demonstrations of computer hardware; sales demonstrations of kitchen appliances; sales demonstrations of surgical instruments; sales promotion for others by means of privileged user cards; sales promotion for others provided through the distribution and the administration of privileged user cards; sales promotion for others through trading stamp schemes; sales volume tracking for others; sales volume tracking services; sample distribution; scrap dealerships; scriptwriting for advertising purposes; search engine optimisation; search engine optimization; secretarial and clerical services; secretarial services; selling domain names; services for provision of foreign trade information; services to determine the audience affected by advertisements; serving as a human resources department for others; shop at home parties selling jewellery; shop at home parties selling lingerie; shop at home parties selling toys; shop window display arrangement services; shop window dressing; shopping centre administration services; shorthand; shorthand secretarial services; shorthand services; shorthand typing; shorthand typing services; social media strategy consulting; sports recruiting services for high school athletes; staff placement services; statistical analysis and reporting services for business purposes; statistical evaluation of data from market studies; statistical evaluation of market research data; statistical evaluations of marketing data; stenographic transcription; stenographic transcription services; stenography; stenography services; strategic business analysis; strategic business planning; street vending of flowers; street vending of food; subscription to a television channel; subscriptions to

books; subscriptions to comic books; subscriptions to electronic journals; subscriptions to newspapers; subscriptions to reviews; supermarkets; supply chain management services; talent agencies; talent agency services in the nature of business management of performing artists; talent management agencies; tax advisory services; tax and taxation planning, advice, information and consultancy services; tax auditing; tax auditing services; tax declaration procedure services; tax filing services; tax preparation; tax preparation services; telemarketing services; telephone and television auctions; telephone answering for unavailable subscribers; telephone answering service; telephone answering services; telephone directory assistance services; telephone order-taking services for others; telephone voice message transcription services; television advertising for others; temporary employment agencies; temporary employment agency services; temporary personnel services; testing to determine employment skills; testing to determine professional competency; theatrical agencies; tracking and monitoring energy consumption for others for account auditing purposes; tracking and monitoring fluctuation in gasoline prices for others for account auditing purposes; travel management; travel reward programs; typing; typing services; updating and maintenance of data in computer databases; utility meter reading for billing purposes; vehicle registration and title transfer; vending machine services; voter registration; wage payroll preparation; web indexing for commercial or advertising purposes; web site optimization services; web site traffic optimisation; web site traffic optimization; wholesale sales of auto parts; wholesale sales of clothing; wholesale sales of cosmetics; wholesale sales of home entertainment electronics; wholesale sales of sporting goods; wholesale services for pharmaceutical, veterinary and sanitary preparations and medical supplies; wholesale store services featuring audiovisual equipment; wholesale store services featuring baked goods; wholesale store services featuring beer; wholesale store services featuring chocolate; wholesale store services featuring clothing; wholesale store services featuring cookware; wholesale store services featuring cutlery; wholesale store services featuring desserts; wholesale store services featuring diving equipment; wholesale store services featuring ice cream; wholesale store services featuring saddlery; wholesale store services featuring smartphones; wholesale store services featuring smartwatches; wholesale store services featuring sorbets; wholesale store services featuring teas; wholesale store services featuring toys; window display arrangement services; window display services; window dressing services for advertising purposes; word processing; word processing and typing services; work analysis to determine worker skill sets and other worker requirements; writing of curriculum vitae for others; writing of publicity texts for others; writing of résumés for others

### **Class 36**

(2) acceptance of bill payments; acceptance of bills of exchange; acceptance of monetary charitable contributions; acceptance of monetary charitable contributions to fund medical research; accepting monetary charitable contributions; accepting monetary charitable contributions to fund medical research; accident insurance agency services; accident insurance brokerage; accident insurance consultancy; accident insurance information; accident insurance services; accident insurance underwriting; accident insurance underwriting services; accounts payable debiting services; accounts receivable financing; acquisition of land for others; acquisition of real estate for others; actuarial services; ad valorem appraisals of real estate; advisory services in the field of credit and debit control, investment, grants and financing of loans; agencies for brokerage of securities trading in overseas securities markets and of transactions on commission of overseas market securities futures; agencies for collecting electric power utility payments; agencies for collecting gas utility payments; agencies for commodity futures trading; agencies for leasing of land; agencies for renting of buildings; agencies for renting of land; annuity underwriting; antique appraisal; apartment and office rentals; apartment house management; apartment management services; apartment rental; appraisal of intellectual property; appraisal of real estate; appraisal of

yachts; appraisals for insurance claims of personal property; appraisals for insurance claims of real estate; arranging and provision of credit, loans, insurance, currency exchange and travellers cheques; arranging finance for construction projects; arranging of leases and rental agreements for real estate; arranging of loans; art appraisal; art appraisals; art brokerage; assessing insurance claims; assessment and evaluation of jewellery; assessment and management of real estate; atm banking services; automated teller machine services; automobile lease financing; bail bonding services; bail-bonding; banking services; bill payment services; bill payment services provided through a web site; bill payment services provided through a website; brokerage for liquidation of securities; brokerage for renting of buildings; brokerage for securities liquidation; brokerage of bonds; brokerage of carbon credits; brokerage of shares; brokerage of shares and other securities; brokerage of shares and stocks; brokerage services for capital investments; brokerage services for stocks and bonds; brokerages for leasing of land; brokerages for renting of land; building leasing; building management; business credit verification services; capital investment; capital investment consulting services; capital investment services; capital investments; cash and foreign exchange transactions; cash card services; cash management; charge card and credit card services; charge card services; charitable fund raising; charitable fund raising campaigns; charitable fund raising in view of disaster precautions and prevention; charitable fundraising in view of disaster precautions and prevention; charitable fundraising services; charitable services awarding grants to youth sports organizations; check cashing services; check payment guarantee services; check verification services; cheque cashing services; cheque guarantee card services; cheque processing; cheque verification; claim adjustment for non-life insurance; coin appraisal; collection of debts; collection of donations for charitable purposes; collection of rents; commodity exchange services; commodity trading; computer analyses of stock exchange information; conducting foreign exchange transactions for others; consultancy concerning financing of energy projects; consultancy of capital investment; consultancy services in relation to the financing of civil works and infrastructure projects; consulting and information concerning insurance; credit agencies; credit agency services; credit and cash card services; credit and debit card services; credit and loan services; credit bureau services; credit bureaus; credit bureaux; credit card and debit card services; credit card and payment card services; credit card services; credit card transaction processing services; credit card verification; credit consultation; credit counseling services; credit counselling; credit inquiry and consultancy; credit inquiry and consultation services; credit rating services; credit recovery and collection services; credit scoring services; credit unions; currency exchange; currency trading; customs brokerage; debit account services using a computer readable card; debit account services using a scannable wristband; debit card services; debt advisory services; debt collection; debt collection agencies; debt collection recovery services; debt consolidation services; debt management services; debt recovery services; diamond appraisal; disability insurance services; domestic remittance services; domestic remittance services provided on-line; duty drawback services; electronic banking via a global computer network; electronic bill payment; electronic check acceptance services; electronic cheque acceptance services; electronic funds transfer; electronic funds transfer by telecommunications; electronic Internet banking via a global computer network; electronic processing and transmission of bill payment data; electronic toll collection services; electronic transfer of funds; electronic transfer of money; eleemosynary services in the field of monetary donations; equine appraisals; equity capital investment; equity investment in international companies; escrow services for the travel industry; estate planning; estate trust management; estate trust planning; estimating car repair costs; estimating construction costs; estimating home improvement costs; evaluation of real property; evaluation of the credit worthiness of companies and private individuals; farm credit financing agency services; fiduciary representative services; financial advisory services relating to joint ventures; financial analyses; financial analysis; financial analysis and preparation of reports relating thereto; financial analysis

and research services; financial analysis consultation services; financial appraisals; financial appraisals in responding to calls for tenders; financial appraisals in responding to requests for proposals [RFPs]; financial asset management; financial clearinghouse services; financial consultation in the field of cryptocurrency; financial credit scoring services; financial customs brokerage services; financial evaluation for insurance purposes; financial evaluation of alpaca fibre; financial evaluation of development costs relating to the oil, gas and mining industries; financial evaluation of standing timber; financial evaluation of wool; financial exchange of data between financial institutions and their customers; financial forecasting; financial guarantee and surety; financial guarantee and surety services; financial investment analysis and stock research; financial investment brokerage; financial investment counselling; financial investment in the field of securities; financial investments in the field of commodities; financial investments in the field of gold; financial investments in the field of mutual funds; financial investments in the field of securities; financial management; financial management of employee pension plans; financial management of reimbursement payments for others; financial management of retirement accounts; financial management via the internet; financial placement of private equity funds for others; financial planning; financial planning and investment advisory services; financial planning for retirement; financial restructuring services; financial risk assessment services; financial securities brokerage services; financial services, namely, debt settlement; financial services, namely provision of a cryptocurrency blockchain for digital currency exchange and trading services; financial sponsorship of hockey tournaments; financial trust management; financial trust operations; financial trust planning; financial valuation of personal property and real estate; financial valuation of standing timber; financial valuation of wool; financial valuations; financially-guaranteed financing; financing of automobiles; financing of industrial activities; financing of loans; financing of loans and discounting of bills; financing of purchases; fire insurance services; fire insurance underwriting; fiscal assessment and evaluation; fiscal assessments; fiscal valuations; fiscal valuations and assessments; flat rental; foreign currency exchange services; foreign exchange transactions; formation, offering and management of limited partnerships; fund investments; fund-raising services; fundraising services; funds investment; futures exchange services; grain futures trading; health insurance underwriting; hire purchase financing services; hire-purchase financing; home banking; installment loans; instalment loans; insurance actuarial services; insurance agencies; insurance brokerage; insurance claims adjusting; insurance claims processing; insurance consultancy; insurance premium rate computing; insurance services; insurance underwriting; intellectual property valuation services; internet banking; Internet banking services; investment agencies in the field of securities; investment banking; investment banking services; investment clubs; investment management; investment of funds; investment of funds for others; investment risk assessment services; issuance of bank checks; issuance of credit cards; issuance of debit cards; issuance of letters of credit; issuance of travelers' checks; issuance of travellers' cheques; issue of traveller's cheques; issuing credit cards; issuing of bank cheques; issuing of checks and letters of credit; issuing of cheques; issuing of credit cards; issuing of debit cards; issuing of letters of credit; issuing of travellers' cheques and letters of credit; jewellery appraisal; jewelry appraisal; land leasing; lease of real estate; lease-purchase financing; lease-purchase financing services; lease-purchase of buildings; leasing of apartments; leasing of buildings; leasing of farms; leasing of land; leasing of office space; leasing of real estate; leasing of residential condominiums located within hotel developments; leasing of shopping mall space; life insurance brokerage; life insurance underwriting; life insurance underwriting services; loan syndication; maintaining escrow accounts for investments; making payments on pre-paid long distance calling cards for recharging minutes; management of a capital investment fund; management of apartment houses; management of apartments; management of office buildings; management of portfolios comprising securities; management of portfolios of transferable

securities; marine accidents insurance underwriting; marine fire insurance underwriting; marine insurance underwriting; marine insurance underwriting services; marine transportation insurance underwriting; merchant banking; merchant banking and investment banking services; monetary exchange; monetary exchange operations; monetary exchange services; money exchange services; money order services; money transfer; money wiring services; mortgage banking; mortgage brokerage; mortgage refinancing; mortgage services; motor vehicle insurance underwriting; mutual fund advisory services; mutual fund brokerage; mutual fund brokerage services; mutual fund services; mutual funds; mutual funds and capital investment; numismatic appraisal; online banking; on-line banking services; online banking services accessible by means of downloadable mobile applications; on-line real-time currency trading; options trading services; organization of stock exchanges for the benefit of the trade of stocks and other financial values; pawn brokerage; pawn shops; pawnbrokerage; pawnshops; payment card services; payment gateway services; payroll tax debiting; precious stone appraisal; pre-paid calling card services; pre-paid credit card services; pre-paid funeral expenses services; pre-paid gift card services; pre-paid travel card services; preparing financial reports; private equity fund investment services; private financial placement of hedge funds for others; private financial placement of securities and derivatives for others; processing electronic payments made through prepaid cards; processing of credit card payments; processing of debit card payments; processing of insurance claims and payment data; project financing; property evaluation; property management; property management consulting services; providing bank account information by telephone; providing educational scholarships; providing extended warranties on automobiles; providing extended warranties on computer equipment; providing extended warranties on household appliances; providing extended warranties on photographic equipment; providing information in insurance matters; providing information in the field of the purchase of new homes and condominiums via an Internet website portal; providing insurance information; providing insurance information and consultancy; providing on-line news in the field of finance; providing rebates at participating establishments of others through use of a membership card; providing stock market information; providing stock securities market information; providing student loans; provision of stock market information; quotation of stock market prices; real estate agencies; real estate agency services; real estate appraisal; real estate appraisal and valuation; real estate appraisals; real estate brokerage; real estate brokers; real estate consultancy; real estate consultation; real estate investment; real estate investment services; real estate management; real estate management services; real estate syndication; real estate time sharing; real estate valuation services; rent collection; rental of apartments; rental of automated-teller machines; rental of buildings; rental of cabins; rental of cash dispensers; rental of farms; rental of flats; rental of offices for co-working; rental of real estate; rental of shopping centre space; renting of apartments; renting of buildings; renting of flats; risk management services; safe deposit services; safety deposit box services; savings and loan services; securities brokerage; securities lending; stamp appraisal; stock brokerage services; stock broking services; stock exchange information; stock exchange information services; stock exchange quotation and listing services; stock exchange quotation services; stock exchange quotations; stock price quotations services; stocks and bonds brokerage; stocks and bonds brokerage services; surety services; tax payment processing services; telephone banking; telephone banking services; telephone calling card services; trading of overseas market securities futures; traveller cheque issuance; trust company services; trustee services; valuation of gemstones; valuation of precious metals; valuation of precious stones; valuation of yachts; valuations in real estate matters; vehicle insurance underwriting; venture capital financing; venture capital fund management; venture capital funding services for research institutions; venture capital funding services for universities; viatical settlement services; warranty insurance services; yacht appraisal; yacht brokerage; yacht financing services

**Class 45**

(3) accident investigations; adoption agencies; adoption agency services; adoption placement; advisory services relating to intellectual property rights; airline passenger security screening services; airport baggage security inspection services; airport security services; alarm response and verification services; alternative dispute resolution services; animal adoption services; animal adoption services consisting of arranging homes for dogs and cats from animal shelters; animal cruelty investigation; arbitration, mediation and dispute resolution services; arbitration services; arbitration services in the field of industrial relations; arbitration services relating to industrial relations; assisting in the locating of lost pets; astrological forecasting; astrology consultancy; attorney services; authentication of credit card applications; awarding of licenses for franchising concepts; baby sitting; babysitting; background investigation services; baggage handling inspection services; baggage inspection for security purposes; baggage screening for security purposes; baggage security inspections for airlines; bereavement counselling services; birth registration services; bodyguard services; bomb detection and disposal services; bomb detection services; burial services; cartomancy services; cartoon character licensing; cemetery services; chaperoning; chaperoning services; child care services; civil defence services; civil defense services; clairvoyant fortune-telling services; clothing rental; companionship services for the elderly and disabled; computer assisted litigation support; computer dating services; computer software licensing; concierge services; conducting civil marriage ceremonies; conducting funeral ceremonies; conducting religious prayer services; conflict resolution services; consultancy in the field of litigation; consultancy on regulations on safety at work; consultancy relating to computer software licensing; consultancy relating to copyright protection; consultancy relating to domain name registration services; consultancy relating to patent licensing; consultancy relating to patent protection; consultancy relating to the licensing of computer software; consultancy relating to the licensing of intellectual property; consultancy relating to the management of intellectual property; consultancy relating to the protection of geographical indications; consultancy relating to the protection of industrial designs; consultancy relating to the protection of new plant varieties; consultancy relating to trademark licensing; consultancy relating to trademark protection; consultancy services in the field of home security; consultancy services in the field of national security; consultancy services in the field of personal fashion; consultancy services relating to the legal aspects of franchising; consultancy services relating to the planning and arranging of wedding ceremonies; consultation in the field of data theft and identity theft; consultation services in the field of the safety needs of commercial and industrial companies; consulting and legal services in the field of privacy and security laws, regulations, and requirements; consulting in the field of workplace safety; consulting services in the field of national security; control of building environmental access and security systems; conveyancing services; copyright and industrial property rights management; copyright licensing; copyright licensing agency services; copyright management; copyright management consultation; counselling services in the field of Christian conduct in personal relationships; court reporting; cremation services; crematorium services; dating agency services; dating services; detective agencies; detective agency services; detective investigations; dispute resolution services; divorce mediation services; dog walking services; domain name registration; domain name registration services; embalming services; emergency alert services; escort services; evangelistic and ministerial services; evangelistic ministerial services; evening dress rental; expert witness services in the field of crime scene reconstitution; expert witness services in the field of forensic science; expert witness services in the field of mental health; exploitation of industrial property rights and copyright by licensing; film, television and video licensing; fingerprint registration; fingerprinting and fingerprint registration of children; fingerprinting services; fire fighting services; fire prevention consultancy; fire prevention



consultation services; fire-fighting; footwear rental; forecasting services in the nature of fortune-telling; forensic analysis of surveillance video for fraud and theft prevention purposes; fortune-telling; foster care; fraud and identity theft protection services; fraud detection services in the field of banking; fraud detection services in the field of credit cards; fraud detection services in the field of credit cards for online purchasing; fraud detection services in the field of health care insurance; fraud detection services in the field of insurance; fugitive recovery services; funeral arrangement services; funeral home services; funeral homes; funeral service undertaking; funeral services accompanying cremation; funeral services accompanying cremation of pets; funerals; funerary undertaking; genealogical research; genealogy research; granting of licences for franchise concepts; granting of licences for industrial property rights; granting of licences to others for the use of industrial property rights and copyright; granting of software licences; granting of software licences and granting of licences for industrial property rights; granting of software licenses and granting of licenses for industrial property rights; guard patrol security services; guard services for preventing the intrusion of burglars; guardianship services; handbag rental; handbags rental; hat rental; home sitting; horoscope casting; horoscope forecasting; house sitting; industrial property consultancy; industrial property watching services; information about personal wardrobe styling services; information relating to fashion coordination services for individuals; inspection of factories for safety purposes; intellectual property consultancy; intellectual property consultancy services for inventors; intellectual property consultancy services for non-profit organizations; intellectual property consultancy services for universities and research institutions; intellectual property consultancy services in the field of patents and patent applications; intellectual property consultation services; intellectual property licensing services; intellectual property watch services; interment services; Internet dating services; Internet-based matchmaking services; Internet-based personal introduction services; Internet-based social introduction services; Internet-based social networking services; investigating into missing persons; investigation services related to insurance claims; issue of licensing rights relating to films; issue of licensing rights relating to television productions; issue of licensing rights relating to video productions; issuing licences for franchising concepts; kimono dressing assistance; leasing of crowd control barriers; leasing of internet domain names; leasing of security surveillance equipment; leasing reproduction rights of photographs and transparencies to others; legal administration of licenses; legal advice; legal advice in responding to calls for tenders; legal advice in responding to requests for proposals [RFPs]; legal advice relating to franchising; legal advocacy services; legal and judicial research services in the field of intellectual property; legal assistance in the drawing up of contracts; legal consultancy on the topics of television advertising, television entertainment and sports; legal consultancy relating to franchising; legal consultancy relating to intellectual property rights; legal consultation in the field of taxation; legal consultation services; legal document preparation and research services for attorneys; legal document preparation services; legal information agencies; legal information services; legal investigation services; legal research; legal research relating to business mergers; legal research relating to intellectual property rights; legal research relating to real estate transactions; legal research services; legal services; legal services for procedures relating to industrial property rights; legal services in relation to the negotiation of contracts for others; legal services provided in relation to lawsuits; legal services relating to claims management for insurance companies, insurance brokers and industrial enterprises; legal services relating to company formation and registration; legal services relating to copyright licensing; legal services relating to the exploitation of ancillary rights in the field of merchandising; legal services relating to the exploitation of ancillary rights relating to film, television, video and music productions; legal services relating to the exploitation of broadcasting rights; legal services relating to the exploitation of copyright and industrial property rights; legal services relating to the exploitation of copyright for printed matter; legal services relating to the exploitation of film copyright; legal services relating to

the exploitation of industrial property rights and copyright; legal services relating to the exploitation of intellectual property rights; legal services relating to the exploitation of patents; legal services relating to the management and exploitation of copyright and ancillary copyright; legal services relating to the management, control and granting of licence rights; legal services relating to the negotiation and drafting of contracts relating to intellectual property rights; legal services relating to the protection and exploitation of copyright for film, television, theatre and music productions; legal services relating to the registration of trademarks; legal support services; licensing authority services; licensing of advertising slogans; licensing of advertising slogans and cartoon characters; licensing of architectural drawings to others; licensing of books; licensing of cartoon characters; licensing of computer programmes; licensing of computer programs; licensing of computer software; licensing of computer software and industrial property rights; licensing of franchising concepts; licensing of industrial property rights; licensing of industrial property rights and copyright; licensing of intellectual property; licensing of intellectual property and copyright; licensing of music; licensing of musical works; licensing of patent applications; licensing of patents; licensing of patents and patent applications; licensing of radio and television programmes; licensing of radio and television programs; licensing of rights relating to films; licensing of rights relating to television productions; licensing of rights relating to the use of photographs; licensing of rights relating to video productions; licensing of rights to films, television and video productions; licensing of software; licensing of trademarks; licensing services relating to music publishing; lifeguard services; litigation advice; litigation consultancy; litigation services; litigation support services; lost and found bureau services; lost and found services; lost property return; lost property return services; management and exploitation of industrial property rights and copyright by licensing for others; management of copyright and industrial property rights; management of copyright and industrial property rights for others; management of industrial property rights and copyright; marriage agencies; marriage agency services; marriage bureau services; marriage bureaus; marriage counselling; marriage guidance counseling; marriage partner introduction; matchmaking services; mediation; mediation in legal procedures; mediation services; military camps; ministerial services; missing person investigations; missing persons investigation; missing persons investigations; monitoring industrial property rights for legal advisory purposes; monitoring intellectual property rights for legal advisory purposes; monitoring of burglar alarms; monitoring of burglar and security alarms; monitoring of fire alarms; monitoring of home security systems; monitoring telephone calls from subscribers and notifying emergency facilities; mummification services; music licensing services; nanny services; night guard services; night watchman services; notary public services; online dating club services; online social introduction services; on-line social networking services; online social networking services; online social networking services accessible by means of downloadable mobile applications; opening of door locks; opening of security locks; organization of political meetings; organization of religious meetings; organizing meetings of bereaved families to commemorate the death of a loved one; paralegal services; paranormal investigation services; pastoral counselling; patent and industrial property consultation; patent and patent application licensing; patent licensing; personal background investigations; personal body guarding; personal fashion consulting services; personal gift selection for others; personal growth and motivation consulting services; personal legal affairs consultancy; personal letter writing; personal letter writing for others; personal reminder services in the area of upcoming important dates and events; personal selection of gifts for customized gift boxes; personal shopping for others; personal styling services consisting of bra measuring and fitting services; personal styling services consisting of measuring and fitting services for ladies' lingerie; personal wardrobe styling consultancy; personal wardrobe styling services; pet cremation services; pet funeral services accompanying cremation; pet registration; pet sitting; planning and arranging of wedding ceremonies; police and civil protection services; police protection services; polygraph

examination services; pre-employment background investigation services; pre-employment background screening services; preparation of customized gift baskets; preparation of customized gift boxes; preparation of legal documents; preparation of legal reports in the field of human rights; private investigation and security services; private investigation services; pro bono legal services; professional legal consultations relating to franchising; professional legal franchise consulting; providing a selection of online electronic greeting cards; providing and conducting non-denominational, non-religious civil marriage ceremonies; providing and conducting civil marriage ceremonies; providing clothing for charitable purposes; providing companionship services for families of patients with life threatening disorders; providing consultation and information in the field of emergency response for communities; providing electronic greeting cards via the Internet; providing emotional support to cancer patients and their families via interactive online forums; providing grave spaces or charnel houses; providing horoscope information via computer networks; providing information about intellectual and industrial property rights; providing information about legal services via a website; providing information about patents and patent applications from a website; providing information from a computer database about investigation services relating to lost or stolen vehicles; providing information in the field of intellectual property; providing information in the field of legal affairs; providing information in the field of patent applications via an online searchable database; providing information in the field of political issues; providing information on agencies for copyright licensing; providing information on clothing rental; providing information on industrial property rights; providing information on issues concerning human rights; providing information on the development of privacy, security and data governance law from a website; providing information relating to copyright licensing agencies; providing information relating to personal body guarding services; providing information relating to security guard services; providing information relating to the rental of fire alarms; providing information relating to the rental of fire extinguishers; providing information via interactive online websites in the field of dating and to facilitate introduction of individuals and development of relationships and friendships; providing legal information; providing legal information from an online interactive database; providing online electronic greeting cards; providing on-line information in the field of spirituality, self-help, and personal empowerment subject matters; providing patient advocate services to hospital patients and patients in long-term care facilities; providing personal support services for cancer patients and their families; providing personal support services for families of patients with life threatening disorders; providing reconnaissance and surveillance services; providing user authentication services in e-commerce transactions; providing wedding officiant services; provision of expert legal opinions; psychic reading services; registration of domain names; registration of domain names for identification of users on a global computer network; releasing doves for special occasions; religious counselling services; reminder services for personal dates and event; reminder services of dates and events; rental of altars; rental of clothing; rental of dresses; rental of evening dresses; rental of evening wear; rental of fire alarms; rental of fire extinguishers; rental of footwear; rental of formal wear; rental of handbags; rental of hats; rental of jewellery; rental of life jackets; rental of protective helmets; rental of protective masks; rental of safes; rental of security surveillance equipment; rental of shoes; rental of signs for personal messages; rental of tuxedos; rental of uniforms; rental of watches; rental of wedding chuppahs; rental of wedding huppahs; representation and assistance in legal disputes before arbitration, mediation, and alternative dispute resolution bodies; reviewing standards and practices to assure compliance with anti-corruption laws and regulations; reviewing standards and practices to assure compliance with environmental regulations; reviewing standards and practices to assure compliance with zoning regulations; safety auditing to improve safety of construction workers on residential construction sites; security clearance for preparation of identification cards; security control of persons and luggage in airports; security guard services; security guard services for

buildings; security guard services for the protection of property and individuals; security guarding for facilities; security inspection of baggage at airports; security inspection services for others; security printing in the form of encoding identification information on valuable documents and products; security screening of airline passengers; security screening of baggage; security services for the protection of material assets or persons; security services for the protection of property and individuals; shoe rental; skip tracing services; social introduction agencies; social introduction agency services; software licensing; spiritual consultancy; stolen vehicle recovery services; stolen vehicle tracking services; store security services; surveillance services; telemetry monitoring of exact location of wild animals; title searching; tracking and iris or retina scanning as means of identifying pets; tracking of stolen property; tracking of stolen vehicles; trademark agent services; trade-mark monitoring services; trademark watch services; tuxedo rental; undertaking; undertaking services; video dating services; watch rental; wedding ceremony planning and arranging consultation services; wedding chapel services; zodiac consultation

**Application Number** 1,966,113  
**Language of Application** English

**Filing Date** 2019-05-31

## APPLICANT AND AGENT DETAILS

### Applicant

PINTY'S DELICIOUS FOODS INC.  
5063 North Service Road  
Suite 101  
Burlington  
ONTARIO  
L7L5H6

### Agent

ROBIC  
630, boul. René-Lévesque Ouest, 20e étage,  
Montréal, QUEBEC, H3B1S6

## TRADEMARK DETAILS

# PINTY'S MAN CAVE

### Trademark Type

Standard Characters

### Goods

#### Class 29

(1) Meat and poultry, namely, pork, beef, chicken, turkey; meat proteins, namely meat substitutes; chicken proteins; turkey proteins; cheese dips;

#### Class 30

(2) condiments, sauces and dips used for pork, beef, chicken, turkey, namely, barbecue sauce, mustard, cheese sauce, chilli sauce, fish sauce, gravy sauce, hot sauce, pepper sauce, soya sauce, tartar sauce, salad dressings;

### Services

#### Class 35

Promoting the sale of meat, poultry, pork, beef, chicken, turkey, meat proteins, namely meat substitutes, chicken proteins, turkey proteins, condiments, sauces and dips used for pork, beef, chicken, turkey, namely, barbecue sauce, mustard, cheese sauce, chilli sauce, fish sauce, gravy sauce, hot sauce, pepper sauce, soya sauce, tartar sauce, salad dressings and cheese dips through promotional contests and the distribution of related printed material.

**Application Number** 1,968,221  
**Language of Application** English

**Filing Date** 2019-06-10

## APPLICANT AND AGENT DETAILS

### Applicant

THE TORONTO-DOMINION BANK  
66 Wellington Street West  
Toronto Dominion Tower  
12th Floor  
Toronto  
ONTARIO  
M5K1A2

### Agent

FASKEN MARTINEAU DUMOULIN LLP  
333 BAY STREET, SUITE 2400, BAY  
ADELAIDE CENTRE, BOX 20, TORONTO,  
ONTARIO, M5H2T6

## TRADEMARK DETAILS

# TD BANK

### Trademark Type

Word

### Goods

#### Class 06

(1) Alloys of common metal; ores of metal; ingots made of common metal and metal alloys; statues, busts and works of art made of metal and metal alloys; safes and strongboxes made of metal or non-metal

#### Class 09

(2) Computer software and mobile applications for electronically trading securities and managing financial portfolios; computer software and mobile applications for online, internet and mobile banking; computer software and mobile applications for financial management and financial planning; Computer software and downloadable mobile applications in the field of insurance services, namely filing and processing insurance claims, providing insurance services and insurance quotes and providing information regarding insurance services; electronic payment terminals; credit and debit cards; downloadable and non-downloadable electronic publications in the nature of magazines, newsletters and brochures in the fields of banking, finance, investment, insurance and securities trading

#### Class 14

(3) Alloys of precious metal; badges of precious metal; boxes of precious metal; busts of precious metal; coins and commemorative coins; diamonds; jewellery; gold; ingots of precious metal; key rings and key chains; medals; pearls; platinum; precious metals; precious stones; rings made of precious metals; silver; works of art of precious metal

#### Class 16

(4) Printed publications, namely, magazines, newsletters, guides, manuals, pamphlets, brochures and catalogues of products, all in the fields of banking, financial advisory, investment management, mutual fund, insurance, insurance brokerage and underwriting, real estate, credit card and securities brokerage services

**Class 18**

(5) All purpose carrying bags; sports bags

**Class 20**

(6) Furniture, namely armchairs; mother-of-pearl; statues of amber and works of art made of amber; yellow amber; mirrors; picture frames

**Class 21**

(7) Mugs; glasses; water bottles; bottle openers

**Class 25**

(8) Clothing, namely t-shirts, sweatshirts, sports jerseys, gloves, jackets, scarves, socks and baby clothes; headwear, namely baseball caps, toques, visors and ear muffs; footwear, namely shoes, sports shoes and baby shoes

**Class 32**

(9) Beers; mineral and aerated waters; fruit juices; vegetable juices; soft drinks and carbonated soft drinks

**Class 33**

(10) Wine; distilled alcoholic beverages, namely vodka, rum, whiskey, tequila and gin; alcoholic coolers

**Class 34**

(11) Tobacco and pipe tobacco; cigarettes; e-cigarettes; oral vaporizers for smoking purposes; cigars; smokers' articles, namely lighters, ashtrays, cigarette rolling papers, machines for rolling cigarettes and matches; dried marijuana, marijuana cigarettes, marijuana for smoking, marijuana oil for electronic cigarettes and marijuana oil for oral vaporizers for smoking; oral vaporizers for smoking marijuana

**Services****Class 35**

(1) Statement production, namely, preparation of financial statements for others; preparing business reports containing financial and economic information; credit and debit card reward program services; arranging and conducting incentive reward programs to promote the sale of products and services of others; business management and administration services and consulting services; business consulting services in the field of business acquisitions and mergers; environmental initiatives, namely promoting public awareness of reducing the environmental footprint of business operations, environmental programs and green products and services of others relating to the banking, insurance and financial services industries; online payroll preparation

**Class 36**

(2) Banking, online banking and mobile banking services; investment and financial asset management services; financial planning and investment advisory services; mutual fund and mutual fund brokerage services; securities brokerage services; financial services, namely money lending and credit and loan services secured by assets; commercial lending, mortgage lending services, real estate lending services and securities lending; mortgage and online mortgage services; real estate financing; payment gateway services; bill payment services; stock exchange quotation and listing services; monetary and currency exchange services; automobile financing services; credit and debit card services; insurance claim processing and insurance underwriting services in the fields of life, health, travel, accident, fire, home, pet and automobile insurance; insurance brokerage; automated coin counting, sorting and converting services; estate planning

and estate trust management services; providing grants and financial support to charitable organizations and governmental bodies for education, health, civic and community support, conservation of natural resources and support of philanthropy; philanthropic and charitable services, namely charitable fund raising for the purpose of supporting environmental community initiatives and raising environmental awareness; financial sponsorship of sporting games, exhibitions, contests and tournaments, e-sports games, contests, exhibitions and tournaments, musical performances and concerts, theatrical performances, comedy events, educational presentations and workshops and environmental programs and initiatives

### **Class 37**

(3) Building construction services; house building and repair; maintenance and repair of buildings; renovation and restoration of buildings; installation of doors and windows; kitchen equipment installation

### **Class 38**

(4) Providing multiple user access to a global computer information network for the transfer and dissemination of a wide range of information; electronic transmission of electronic payment data via a global computer network; telecommunications gateway services, namely, providing an online website featuring hyperlinks to redirect consumers to news, financial information and business information in the fields of banking, finance, investment, insurance and securities trading; providing electronic transmission of credit, debit and gift card transaction data, electronic payment data and secure banking, securities trading and insurance claim data via a global computer network

### **Class 41**

(5) Entertainment services, namely, organizing and hosting exclusive receptions at sporting events and concerts; educational services, namely, conducting training classes, seminars, conferences, and workshops in the fields of banking, financial services, strategy, leadership and customer service; educational services, namely children's programs in the fields of banking and financial services and educational presentations made to school children in the fields of banking, finance, investment, insurance and securities trading; providing information via a website and educational services in the field of supporting environmental community initiatives and raising environmental awareness

### **Class 42**

(6) Data encryption and decoding services; credit, debit and gift card transaction processing services; cryptocurrency payment processing; processing electronic payments made through prepaid cards; secure electronic storage of banking, financial transaction and payment, insurance and securities trading data and metadata; computer software design; computer security consultancy and software security consultancy; computer network security services; computer security consultancy; computer security threat analysis for protecting personal and financial data; data security consultancy; electronic monitoring of personally identifying information to detect identity theft; internet security consultancy in the field of detecting and preventing phishing and cyber-security attacks against personal and financial information; software as a service (SAAS) featuring non-downloadable software for computer network security and for data security

### **Class 45**

(7) Licensing of intellectual property; licensing of computer software; legal services; consulting and legal services in the field of privacy and security laws, regulations and requirements; security services for the protection of property and material assets



**Application Number** 1,968,261  
**Language of Application** English

**Filing Date** 2019-06-10

## APPLICANT AND AGENT DETAILS

### Applicant

THE TORONTO-DOMINION BANK  
66 Wellington Street West  
Toronto Dominion Tower  
12th Floor  
Toronto  
ONTARIO  
M5K1A2

### Agent

FASKEN MARTINEAU DUMOULIN LLP  
333 BAY STREET, SUITE 2400, BAY  
ADELAIDE CENTRE, BOX 20, TORONTO,  
ONTARIO, M5H2T6

## TRADEMARK DETAILS

### Trademark Type

Design

### Visual Representation



**Goods**

**Class 06**

(1) Alloys of common metal; ores of metal; ingots made of common metal and metal alloys; statues, busts and works of art made of metal and metal alloys; safes and strongboxes made of metal or non-metal

**Class 09**

(2) Computer software and mobile applications for electronically trading securities and managing financial portfolios; computer software and mobile applications for online, internet and mobile banking; computer software and mobile applications for financial management and financial planning; computer software and downloadable mobile applications in the field of insurance services, namely filing and processing insurance claims, providing insurance services and insurance quotes and providing information regarding insurance services; electronic payment terminals; credit and debit cards; downloadable and non-downloadable electronic publications in the nature of magazines, newsletters and brochures in the fields of banking, finance, investment, insurance and securities trading

**Class 14**

(3) Alloys of precious metal; badges of precious metal; boxes of precious metal; busts of precious metal; coins and commemorative coins; diamonds; jewellery; gold; ingots of precious metal; key rings and key chains; medals; pearls; platinum; precious metals; precious stones; rings made of precious metals; silver; works of art of precious metal

**Class 16**

(4) Printed publications, namely, magazines, newsletters, guides, manuals, pamphlets, brochures and catalogues of products, all in the fields of banking, financial advisory, investment management, mutual fund, insurance, insurance brokerage and underwriting, real estate, credit card and securities brokerage services

**Class 18**

(5) All purpose carrying bags; sports bags

**Class 20**

(6) Furniture, namely armchairs; mother-of-pearl; statues of amber and works of art made of amber; yellow amber; mirrors; picture frames

**Class 21**

(7) Mugs; glasses; water bottles; bottle openers

**Class 25**

(8) Clothing, namely t-shirts, sweatshirts, sports jerseys, gloves, jackets, scarves, socks and baby clothes; headwear, namely baseball caps, toques, visors and ear muffs; footwear, namely shoes, sports shoes and baby shoes

**Class 33**

(9) Wine; distilled alcoholic beverages, namely vodka, rum, whiskey, tequila and gin; alcoholic coolers

**Class 34**

(10) Tobacco and pipe tobacco; cigarettes; e-cigarettes; oral vaporizers for smoking purposes; cigars; smokers' articles, namely lighters, ashtrays, cigarette rolling papers, machines for rolling

cigarettes and matches; dried marijuana, marijuana cigarettes, marijuana for smoking, marijuana oil for electronic cigarettes and marijuana oil for oral vaporizers for smoking; oral vaporizers for smoking marijuana

## **Services**

### **Class 35**

(1) Statement production, namely, preparation of financial statements for others; preparing business reports containing financial and economic information; credit and debit card reward program services; arranging and conducting incentive reward programs to promote the sale of products and services of others; business management and administration services and consulting services; business consulting services in the field of business acquisitions and mergers; environmental initiatives, namely promoting public awareness of reducing the environmental footprint of business operations, environmental programs and green products and services of others relating to the banking, insurance and financial services industries; online payroll preparation

### **Class 36**

(2) Banking, online banking and mobile banking services; investment and financial asset management services; financial planning and investment advisory services; mutual fund and mutual fund brokerage services; securities brokerage services; financial services, namely money lending and credit and loan services secured by assets; commercial lending, mortgage lending services, real estate lending services and securities lending; mortgage and online mortgage services; real estate financing; payment gateway services; bill payment services; monetary and currency exchange services; automobile financing services; credit and debit card services; automated coin counting, sorting and converting services

(3) Insurance claim processing and insurance underwriting services in the fields of life, health, travel, accident, fire, home, pet and automobile insurance; insurance brokerage; stock exchange quotation and listing services; estate planning and estate trust management services; providing grants and financial support to charitable organizations and governmental bodies for education, health, civic and community support, conservation of natural resources and support of philanthropy; philanthropic and charitable services, namely charitable fund raising for the purpose of supporting environmental community initiatives and raising environmental awareness; financial sponsorship of sporting games, exhibitions, contests and tournaments, e sports games, contests, exhibitions and tournaments, musical performances and concerts, theatrical performances, comedy events, educational presentations and workshops and environmental programs and initiatives; secure processing of electronic payments made through debit, credit, gift and prepaid gift cards, online money transfers and units of crypto-currency

### **Class 37**

(4) Building construction services; house building and repair; repair of buildings; renovation and restoration of buildings; installation of doors and windows; kitchen equipment installation

### **Class 38**

(5) Providing multiple user access to a global computer information network for the transfer and dissemination of a wide range of information; electronic transmission of electronic payment data via a global computer network; secure electronic transmission of banking, financial transaction and payment, insurance and securities trading data and metadata via the internet and a global computer network; telecommunications gateway services, namely, providing an online website featuring hyperlinks to redirect consumers to news, financial information and business information in the fields of banking, finance, investment, insurance and securities trading

**Class 41**

(6) Entertainment services, namely, organizing and hosting exclusive receptions at sporting events and concerts; educational services, namely, conducting training classes, seminars, conferences, and workshops in the fields of banking, financial services, strategy, leadership and customer service; educational services, namely children's programs in the fields of banking and financial services and educational presentations made to school children in the fields of banking, finance, investment, insurance and securities trading; providing information via a website and educational services in the field of supporting environmental community initiatives and raising environmental awareness

**Class 42**

(7) Data encryption and decoding services; secure electronic storage of banking, financial transaction and payment, insurance and securities trading data and metadata; computer software design; computer security consultancy and software security consultancy; computer network security services; computer security consultancy; computer security threat analysis for protecting personal and financial data; data security consultancy; electronic monitoring of personally identifying information to detect identity theft; internet security consultancy in the field of detecting and preventing phishing and cyber-security attacks against personal and financial information; software as a service (SAAS) featuring non-downloadable software for computer network security and for data security

(8) Credit, debit and gift card transaction processing services; cryptocurrency payment processing; processing electronic payments made through prepaid cards

**Class 45**

(9) Licensing of intellectual property; licensing of computer software; legal services; consulting and legal services in the field of privacy and security laws, regulations and requirements; security services for the protection of property and material assets

**Application Number** 1,969,769  
**Language of Application** English

**Filing Date** 2019-06-12

## APPLICANT AND AGENT DETAILS

### Applicant

Truss Limited Partnership  
c/o Gowling WLG (Canada) LLP 1 First  
Canadian Place  
100 King Street West, Suite 1600  
Toronto  
ONTARIO  
M5X1G5

### Agent

JOANNE B. NARDI  
Joanne Nardi IP Consulting Services Inc., 117  
Shadow Falls Drive, Richmond Hill, ONTARIO,  
L4E4K2

## TRADEMARK DETAILS

### Trademark Type

Design

### Visual Representation



**Goods****Class 30**

(1) coffee-based beverages containing cannabis; coffee-based beverages containing derivatives of cannabis; tea-based beverages containing cannabis; tea-based beverages containing derivatives of cannabis;

**Class 32**

(2) bottled water containing cannabis; bottled water containing derivatives of cannabis; carbonated beverages infused with cannabis; carbonated soft drinks containing derivatives of cannabis; carbonated soft drinks infused with cannabis oil; cider flavoured beverages infused with cannabis; flavored waters containing cannabis; flavored waters containing derivatives of cannabis; fruit beverages and fruit juices containing cannabis; fruit beverages and fruit juices containing derivatives of cannabis; fruit beverages containing derivatives of cannabis; fruit drinks and juices infused with cannabis oil; fruit juices containing derivatives of cannabis; fruit-based beverages containing cannabis; fruit-based beverages containing derivatives of cannabis; fruit-flavoured beverages infused with cannabis; honey-based beverages infused with cannabis; iced fruit beverages infused with cannabis oil; mineral and aerated waters containing cannabis; mineral and aerated waters containing derivatives of cannabis; smoothies containing cannabis; smoothies containing derivatives of cannabis; sports drinks containing cannabis; sports drinks containing derivatives of cannabis; wine flavoured beverages infused with cannabis; non-alcoholic beer infused with cannabis; non-alcoholic beer-flavoured beverage infused with cannabis

**Application Number** 1,969,770  
**Language of Application** English

**Filing Date** 2019-06-12

## APPLICANT AND AGENT DETAILS

### Applicant

Truss Limited Partnership  
c/o Gowling WLG (Canada) LLP 1 First  
Canadian Place  
100 King Street West, Suite 1600  
Toronto  
ONTARIO  
M5X1G5

### Agent

JOANNE B. NARDI  
Joanne Nardi IP Consulting Services Inc., 117  
Shadow Falls Drive, Richmond Hill, ONTARIO,  
L4E4K2

## TRADEMARK DETAILS

### Trademark Type

Design

### Visual Representation



**Goods****Class 32**

beer-flavoured beverage infused with cannabis; bottled water containing cannabis; bottled water containing derivatives of cannabis; carbonated soft drinks infused with cannabis oil; cider flavoured beverages infused with cannabis; flavored waters containing cannabis; flavored waters containing derivatives of cannabis; fruit beverages and fruit juices containing cannabis; fruit beverages and fruit juices containing derivatives of cannabis; fruit beverages containing derivatives of cannabis; fruit drinks and juices infused with cannabis oil; fruit juices containing derivatives of cannabis; fruit-based beverages containing cannabis; fruit-based beverages containing derivatives of cannabis; fruit-flavoured beverages infused with cannabis; honey-based beverages infused with cannabis; iced fruit beverages infused with cannabis oil; mineral and aerated waters containing cannabis; mineral and aerated waters containing derivatives of cannabis; sports drinks containing cannabis; sports drinks containing derivatives of cannabis;



**Application Number** 1,971,050  
**Language of Application** English

**Filing Date** 2019-06-12

## APPLICANT AND AGENT DETAILS

**Applicant**  
ZAZUBEAN ORGANIC CHOCOLATES LTD.  
111-1529 WEST 6TH AVE  
VANCOUVER  
BRITISH COLUMBIA  
V6J1R1

**Agent**  
MARIE CAPEWELL  
(M. CAPEWELL & ASSOCIATES INC.), Suite  
303 - 1224 HAMILTON STREET,  
VANCOUVER, BRITISH COLUMBIA, V6B2S8

## TRADEMARK DETAILS

# **BUFF**

**Trademark Type**  
Word

**Goods**

**Class 30**

chocolate bars

**Application Number** 1,971,825  
**Language of Application** English

**Filing Date** 2019-06-19

## APPLICANT AND AGENT DETAILS

### Applicant

AGC Manufactura I, S.A. de C.V.  
Vía José López Portillo Número 131  
Colonia La Magdalena  
Coacalco de Berriozábal, Estado de Mexico,  
CP 55700  
MEXICO

### Agent

SMART & BIGGAR LP  
SUITE 900, 55 METCALFE STREET, P.O.  
BOX 2999, STATION D, OTTAWA, ONTARIO,  
K1P5Y6

## TRADEMARK DETAILS

### Trademark Type

Design

### Visual Representation



**Colour Claim**

Colour is claimed as a feature of the trademark. The letter F is red and the graduated shadow is grey.

**Goods****Class 12**

Semi-tractor trailers and truck bodies

**Claims**

Priority Filing Date: April 18, 2019, Country or Office: UNITED STATES OF AMERICA, Application No: 88/392,517 in association with the same kind of goods

**Application Number** 1,972,836  
**Language of Application** English

**Filing Date** 2019-06-26

## APPLICANT AND AGENT DETAILS

### Applicant

AGC Manufactura I, S.A. de C.V.  
Vía José López Portillo Número 131  
Colonia La Magdalena  
Coacalco de Berriozábal, CP 55700  
MEXICO

### Agent

SMART & BIGGAR LP  
SUITE 900, 55 METCALFE STREET, P.O.  
BOX 2999, STATION D, OTTAWA, ONTARIO,  
K1P5Y6

## TRADEMARK DETAILS

### Trademark Type

Design

### Visual Representation





**Goods**

**Class 12**

Semi-tractor trailers and truck bodies

**Claims**

Priority Filing Date: April 17, 2019, Country or Office: UNITED STATES OF AMERICA, Application No: 88/390,649 in association with the same kind of goods

**Application Number** 1,974,943  
**International Registration Number** 0900517  
**Language of Application** English

**Filing Date** 2019-06-25

## APPLICANT AND AGENT DETAILS

### Applicant

Carl Sauter Pianofortemanufaktur GmbH & Co.  
KG  
Max-Planck-Strasse 20  
78549 Spaichingen  
GERMANY

### Agent

RIDOUT & MAYBEE LLP  
250 University Avenue, 5th Floor, Toronto,  
ONTARIO, M5H3E5

## TRADEMARK DETAILS

# SAUTER

**Trademark Type**  
Standard Characters

### Goods

**Class 15**

Pianos.

**Application Number** 1,976,610  
**Language of Application** English

**Filing Date** 2019-07-19

## APPLICANT AND AGENT DETAILS

### Applicant

Devinder Gera  
8222 170A Street  
Surrey  
BRITISH COLUMBIA  
V4N6J4

### Agent

OLLIP P.C.  
Gladwin Business Park, 2212 Gladwin  
Crescent, Building B, Unit B4, Ottawa,  
ONTARIO, K1B5N1

## TRADEMARK DETAILS

# PBB

### Trademark Type

Standard Characters

### Services

#### Class 35

(1) Advice in the running of establishments as franchises, Business administration assistance.

#### Class 44

(2) Health spa resorts, Beauty salon services, Personal hair removal services, Cosmetician services.

#### Class 45

(3) Personal fashion consulting services.

**Application Number** 1,978,796  
**Language of Application** English

**Filing Date** 2019-08-02

## APPLICANT AND AGENT DETAILS

### Applicant

Purely Optimal Nutrition Inc.  
2259 East 52nd Avenue  
Vancouver  
BRITISH COLUMBIA  
V5P1X2

### Agent

ANITA MAR  
dba Trademark Angel, Suite 521, 6-2557  
Dougall Avenue, Windsor, ONTARIO, N8X1T5

## TRADEMARK DETAILS

# PURELY OPTIMAL

### Trademark Type

Standard Characters

### Goods

#### Class 05

dietary supplements for general health and well-being; nutritional supplements for general health and well-being; vitamin and mineral food supplements; vitamins and vitamin preparations



**Application Number** 1,980,774  
**Language of Application** English

**Filing Date** 2019-08-15

## APPLICANT AND AGENT DETAILS

### Applicant

Pure Hothouse Foods Inc.  
459 Highway #77  
P.O. Box 607  
Leamington  
ONTARIO  
N8H3X4

### Agent

MBM INTELLECTUAL PROPERTY AGENCY  
275 SLATER STREET, 14TH FLOOR,  
OTTAWA, ONTARIO, K1P5H9

## TRADEMARK DETAILS

# SNACK+

### Trademark Type

Standard Characters

### Goods

#### Class 31

fresh fruits and vegetables

**Application Number** 1,980,849  
**Language of Application** English

**Filing Date** 2019-08-15

## APPLICANT AND AGENT DETAILS

### Applicant

KOHLER CO.  
444 Highland Drive  
Kohler, WI 53044  
UNITED STATES OF AMERICA

### Agent

MCMILLAN LLP  
BROOKFIELD PLACE, SUITE 4400, BAY  
WELLINGTON TOWER, 181 BAY STREET,  
TORONTO, ONTARIO, M5J2T3

## TRADEMARK DETAILS

# SWITCH-GRIP

### Trademark Type

Standard Characters

### Goods

#### Class 11

Kitchen faucets; faucet sprayers.

**Application Number** 1,982,152  
**Language of Application** English

**Filing Date** 2019-08-26

## APPLICANT AND AGENT DETAILS

### Applicant

Del Monte International GmbH  
74 Boulevard d'Italie  
Monte Carlo, 98000  
MONACO

### Agent

BERESKIN & PARR LLP/S.E.N.C.R.L., S.R.L.  
SCOTIA PLAZA, 40 KING STREET WEST,  
40th FLOOR, TORONTO, ONTARIO, M5H3Y2

## TRADEMARK DETAILS

# FARMER'S FORK

### Trademark Type

Standard Characters

### Goods

#### Class 29

(1) prepared salads comprising of fresh vegetables, fresh fruits, dried fruits packaged with sauces, salad dressings, edible oils, vinegars, seasonings, spices; dips, namely, almond dips, aubergine dips, baba ganoush dips, bean dups, carmelized onion dips, cashew dips, cheese dips, dairy based food dips, fruit-based dips, garlic dips, herbs and spice dips, onion dips, snack food dips, spinach dips; spreads, namely, almond spreads, cheese spreads, chicken spreads, fish spreads, fruit spreads, garlic-based spreads, legume-based spreads, low fat dairy spreads, meat spreads, nut-based spreads, peanut-based spreads, sandwich spread, seafood spreads

#### Class 31

(2) Fresh vegetables, fresh fruits and fresh produce, namely, fresh vegetables, fresh fruits, fresh edible flowers, fresh nuts, fresh legumes, fresh pulses

### Claims

Priority Filing Date: August 23, 2019, Country or Office: UNITED STATES OF AMERICA, Application No: 88590205 in association with the same kind of goods (2); August 23, 2019, Country or Office: UNITED STATES OF AMERICA, Application No: 88590205 in association with the same kind of goods (1)

**Application Number** 1,982,662  
**International Registration Number** 1485194  
**Language of Application** English

**Filing Date** 2019-06-19

## APPLICANT AND AGENT DETAILS

### Applicant

XSYS Germany GmbH  
Industriestrasse 1  
77731 Willstätt  
GERMANY

### Agent

ROBIC  
630, boul. René-Lévesque Ouest, 20e étage,  
Montréal, QUEBEC, H3B1S6

## TRADEMARK DETAILS

# Xsys

### Trademark Type

Standard Characters

### Goods

#### Class 01

(1) Chemical products used in industry, namely solvents for polymers, solvents for use in plastic treatment and the production of printing blocks of plastic; chemical products for industrial purposes for usage in print shops or during printing, namely solvents for printing inks, drying agents for printing inks, water additives for printing inks, as well as fountain solutions and auxiliaries for use in printing inks during printing; auxiliaries [chemicals] for use during the printing process, namely solvents, chemical agents for influencing the drying process, chemical agents for influencing gloss and dullness as well as the surface structure of printing inks, chemical agents for influencing the flowing capability of printing inks; chemical products for photographic purposes, namely unexposed films and plates, as well as such films and plates of which the coating material is chemically altered and becomes insoluble through radiations, due to polymerisation; sensitized photographic plates; sensitized plates for offset printing

#### Class 02

(2) anti-rust preparations, wood preservatives; mordanting agents for wood and leather; mordanting agents for use during dyeing, varnishing and tinting; natural resins; metal foil for painters, decorators, printers and artists;

#### Class 03

(3) cleaning agents for cleaning printing plates; detergents and cleaning agents ready for use in print shops, namely washing agents for rollers; cleaning agents for printing presses and their individual components.

#### Class 07

(4) Printing plates; machine parts, namely coatings, linings and rubber blankets for printing rollers; printing plates of base metals, coated with a material which by radiation due to polymerisation is chemically altered and becomes insoluble; flexographic pre-press printing machines; printing machines namely planographic printing machines, flexographic printing machines, letterpress printing machines; industrial label making machines for commercial use; print finishing machines; steel storage containers for printing plates

**Class 09**

(5) Equipment for exposure and processing of photosensitive printing plates namely plate imagers, laser imagers, light finishers, cutting tables; pre-press plate processors for use in printing; flexographic printing plate processors, exposure machines for exposing printing plates, drying apparatus for printing plates, plate storage machines, computer-to-plate processors; software for color matching of printing inks; print server software

**Class 16**

(6) Printing blocks; printing blankets, mainly comprising a compressible rubber layer and a rubber cover plate.

**Class 17**

(7) Semi-finished plastic plates for the production of printing blocks

**Class 24**

(8) Printing blankets, mainly comprising a textile fabric layer.

**Services****Class 35**

(1) Retail and wholesale services related to the graphic arts industry, namely, Printing inks, chemicals used for printing and photography, sensitized photographic plates, sensitized plates for offset printing, anti-rust preparations, wood preservatives, mordanting agents for wood and leather, mordanting agents for use during dyeing, varnishing and tinting, natural resins, metal foil for painters, decorators, printers and artists, cleaning agents for cleaning printing plates, detergents and cleaning agents ready for use in print shops, namely washing agents for rollers, cleaning agents for printing presses and their individual components, Printing plates, machine parts, namely coatings, linings and rubber blankets for printing rollers, printing plates of base metals, coated with a material which by radiation due to polymerisation is chemically altered and becomes insoluble, flexographic pre-press printing machines, printing machines namely planographic printing machines, flexographic printing machines, letterpress printing machines, industrial label making machines for commercial use, print finishing machines, steel storage containers for printing plates, Equipment for exposure and processing of photosensitive printing plates namely plate imagers, laser imagers, light finishers, cutting tables, plate processors, including such for use in pre-press, flexographic printing plate processors, exposure machines for exposing printing plates, drying apparatus for printing plates, plate storage machines, computer-to-plate processors, software for color matching of printing inks, print server software, Semi-finished plastic plates for the production of printing blocks.

**Class 37**

(2) Maintenance and repair services of printing machines, printing presses, machine parts for printing rollers, flexographic pre-press printing machines, planographic printing machines, flexographic printing machines, letterpress printing machines, industrial label making machines, print finishing machines, printing plate processors, exposure meters for printing plates, drying apparatus for printing plates, plate storage machines and computer-to-plate processors for graphic arts design, exposure machine for exposing printing plates;

**Class 41**

(3) Education and training services for the graphic art industry.

**Class 42**

(4) Technical consulting services for the graphic art industry.

**Claims**

Priority Filing Date: May 29, 2019, Country or Office: GERMANY, Application No: 30 2019 107 130  
in association with the same kind of goods and in association with the same kind of services

**Application Number** 1,982,713  
**International Registration Number** 1485098  
**Language of Application** English

**Filing Date** 2019-07-05

## APPLICANT AND AGENT DETAILS

### Applicant

MHC PROJECTS PTY LTD C/O AKJ Business  
Services Level  
L2, 21 Lake St  
VARSITY LAKES QLD 4227  
AUSTRALIA

### Agent

JAMIE BASHTANYK  
(TRADEMARK DEPOT), 3772 De La  
Goudrelle, Saint-Lazare, QUEBEC, J7T2N1

## TRADEMARK DETAILS

### Trademark Type

Design

### Visual Representation



mindheart

# CONNECT

## Colour Claim

Colour is claimed as a feature of the trademark. The design is comprised of 7 curved bands that spiral inward; the bottom left curved band is dark blue and going counterclockwise, the next curved band is blue, followed by teal, light teal, green, light green and the last curved band is pale green; the terms "mindheart CONNECT" are grey.

## Goods

### Class 16

Educational publications, namely books, textbooks, reference books, instruction books, information books, workbooks, periodic publications, magazines, newsletters, manuals, printed seminar and lecture notes; printed publications, namely books in the field of health education; diaries; weekly planners; wall posters; postcards, greeting cards; calendars; books; books on health, wellness and mental health; paper stationery; pens; pencils; printed advertising and promotional material namely brochures, leaflets, programmes, banners and catalogues.

## Services

### Class 41

Health education, namely, providing mental health education; Education and training services, namely, health coaching in the field of mental health; provision of educational information relating to mental health, wellness and mindfulness; educational instruction in meditation and mindfulness; Presentation of live theatrical performances; Coaching in the field of sports; Life coaching services in the field of personal financing; personal development training; Publishing of books; publication of books; publication of periodicals; publication of electronic books and journals online; Educational services in the field of nutrition; Publication of educational textbooks and educational materials, namely, journals, books, magazines, and manuals; Conducting of instructional, educational and training courses in the field of mental health; Blog services, namely, on-line publication of journals and diaries; Custom speech writing services for nonadvertising purposes; Providing online classes via an online forum in the field of mental health; Providing online electronic books, not downloadable in the field of mental health; Providing entertainment information in the field of television programming; Publication of multimedia material online, namely, podcasts and weblogs; Online electronic publishing of books and periodicals; Webinars in the field of mental wellness; Production of radio programs; Production of audio-visual presentations; Arranging of conferences, exhibitions, seminars, workshops, and competitions for educational and entertainment purposes in the field of mental health; Conducting training seminars and workshops in the field of mental health; Organising of music concerts, baseball games, and community cultural festivals for charitable purposes



**Application Number** 1,983,499  
**Language of Application** English

**Filing Date** 2019-09-04

## APPLICANT AND AGENT DETAILS

**Applicant**  
OGEN LTD.  
5430 30th Street SE  
Calgary  
ALBERTA  
T2C1G2

**Agent**  
MBM INTELLECTUAL PROPERTY AGENCY  
275 SLATER STREET, 14TH FLOOR,  
OTTAWA, ONTARIO, K1P5H9

## TRADEMARK DETAILS

**Trademark Type**  
Design

**Visual Representation**



**Goods**  
**Class 09**

(1) electronic publications, namely newsletters, brochures, reports and guides in the field of medical marijuana, cannabis and cannabis oils; fridge magnets

### **Class 16**

(2) stickers; printed material, namely calendars, note books, greeting cards; magazines, books, cookbooks and newsletters; printed publications, namely newsletters, brochures, reports and guides in the field of marijuana, cannabis and cannabis oils; novelty and promotional items, namely, posters, bumper stickers, decals, stickers, temporary tattoos, postcards, calendars, diaries, cardboard coasters, note pad holders, passport holders, writing paper holders, writing pads, note paper and notebooks

### **Class 18**

(3) all-purpose sport bags, all-purpose athletic bags; backpacks; handbags; tote bags; purses and wallets; travel handbags; fanny packs; waist packs; credit card holders; luggage label holders

### **Class 21**

(4) hand operated herb grinders; novelty and promotional items, namely water bottles, hand operated herb grinders, cups, mugs, beer mugs, jars, travel mugs, insulated flasks, vacuum bottles, drinking glasses, beverage glassware and bottle openers

### **Class 25**

(5) clothing, namely, t-shirts, pants, shorts, tank tops, jackets, sweaters, sweat shirts, dresses, skirts, underwear, swimwear, sleepwear, rainwear; headwear, namely hats, caps, visors and toques; sleep masks; lab coats; scarves; belts; gloves; footwear, namely shoes, boots and sandals; novelty and promotional items, namely t-shirts, pants, shorts, tank tops, jackets, sweaters, sweat shirts, dresses, skirts, underwear, swimwear, sleepwear, rainwear, hats, caps, visors and toques, sleep masks, lab coats, scarves, belts, gloves, shoes, boots and sandals

### **Class 31**

(6) live cannabis plants; cannabis seeds

### **Class 34**

(7) bags and cases specially adapted for holding or carrying marijuana, cannabis and cannabis oils and accessories

## **Services**

### **Class 35**

(1) online and retail sale of fridge magnets, stickers, printed material, namely calendars, note books, greeting cards, magazines, books, cookbooks and newsletters, printed publications, namely newsletters, brochures, reports and guides in the field of marijuana, cannabis and cannabis oils, novelty and promotional items, namely, posters, bumper stickers, decals, stickers, temporary tattoos, postcards, calendars, diaries, cardboard coasters, note pad holders, passport holders, writing paper holders, writing pads, note paper and notebooks, bags and cases specially adapted for holding or carrying marijuana, cannabis and cannabis oils and accessories, all-purpose sport bags, all-purpose athletic bags, backpacks, handbags, tote bags, purses and wallets, travel handbags, fanny packs, waist packs, credit card holders, luggage label holders, clothing, headwear, sleep masks, lab coats, scarves, belts, gloves, footwear, live cannabis plants, cannabis seeds, smoking pipes, electronic smoking pipes, water pipes for smoking, hookahs, oral vaporizers for smokers, vape pens, electronic cigarettes, smokeless cigarette vaporizer pipes, vaporizers for electronic cigarettes, cigarettes

### **Class 39**

(2) packaging of cannabis oil, packaging of capsules; encapsulation of cannabis oil; travel arrangement and hosting spiritual retreats; distribution of cannabis and marijuana for medical purposes; transportation of cannabis and marijuana for medical purposes; distribution of cannabis and marijuana for recreational purposes; transportation of cannabis and marijuana for recreational purposes

**Class 40**

(3) processing of cannabis oil; extraction of oil from cannabis plant matter; custom manufacturing of medical cannabis oil capsules; manufacture of medical cannabis oil capsules to the order and specification of others; manufacture of branded cannabis products in according with third-party orders and specification

**Class 41**

(4) providing information about cannabis and marijuana via a website; providing information featuring the ratings, reviews and recommendations on the subject of cannabis and marijuana posted by users via a website; organizing and hosting tours of marijuana and cannabis cultivation, production, processing and distribution facilities; custom production of cannabis and marijuana for medical purposes; processing of cannabis and marijuana for medical purposes; custom production of cannabis and marijuana for recreational purposes; processing of cannabis and marijuana for recreational purposes

**Class 44**

(5) medical counselling in the fields of cannabis and marijuana; cultivation of cannabis plants; cultivation and growing of cannabis and marijuana for medical purposes; cultivation and growing of cannabis and marijuana for recreational purposes; operation of a medical cannabis and marijuana dispensary; operation of a recreational cannabis and marijuana dispensary; the operation of a marijuana, medical marijuana, and cannabis production facility for the processing of marijuana, cannabis and their related products and cannabis derivatives; operation of a medical clinic that offers medical advice, prescriptions and recommendations, from medical doctors to patients seeking the use of medical marijuana as a treatment option

**Application Number** 1,984,977  
**Language of Application** English

**Filing Date** 2019-09-13

## APPLICANT AND AGENT DETAILS

### Applicant

Nuvera Fuel Cells, LLC  
129 Concord Road, Bldg 1  
Billerica, MA 01821  
UNITED STATES OF AMERICA

### Agent

MACRAE & CO.  
326 Somerset Street West, Ottawa, ONTARIO,  
K2P0J9

## TRADEMARK DETAILS

# NUVERA

### Trademark Type

Standard Characters

### Goods

#### Class 12

Engines for land vehicles; powered industrial lift trucks.

**Application Number** 1,985,286  
**Language of Application** English

**Filing Date** 2019-09-17

## APPLICANT AND AGENT DETAILS

### Applicant

Zhejiang MiLian Technology Co., Ltd.  
No. 825, Nanming Road, Nanmingshan Street  
Liandu District, Lishui City  
Zhejiang Province (Lijing National Industrial  
Park), 323000  
CHINA

### Agent

WITMART INC.  
34 King Street East, Suite 500, Toronto,  
ONTARIO, M5C2X8

## TRADEMARK DETAILS

# ZII

### Trademark Type

Standard Characters

### Goods

#### Class 09

Mileage recorders for vehicles; electric locks for vehicles; computer software for global positioning systems; camcorders; rear-view cameras for vehicles; electrical and electronic burglar alarms; burglar alarms; bicycle helmets; sunglasses

**Application Number** 1,985,403  
**Language of Application** English

**Filing Date** 2019-09-17

## APPLICANT AND AGENT DETAILS

### Applicant

ROCKET MORTGAGE, LLC  
1050 Woodward Avenue  
Detroit, MI 48226  
UNITED STATES OF AMERICA

### Agent

GOWLING WLG (CANADA) LLP  
SUITE 2600, 160 ELGIN STREET, OTTAWA,  
ONTARIO, K1P1C3

## TRADEMARK DETAILS

### Trademark Type

Design

### Visual Representation



### Goods

#### Class 09

Downloadable software in the nature of a mobile application for use for research and analysis in the fields of real estate, consumer lending, mortgages and business loans; downloadable software for use in transmitting payments, transferring funds, and bill payment; downloadable software for online banking, transaction management, financial planning, financial management, bill tracking and management, expense tracking and management, and financial goal tracking; computer application software for managing and accessing financial and banking accounts and carrying out financial transactions; and downloadable mobile applications for managing and accessing financial and banking accounts and carrying out financial transactions.

### Services

#### Class 35

(1) Providing comparison pricing information relating to financial products by means of a global computer network; advertising services for others in the fields of telemarketing and consumer lead prioritization and consultation related thereto; management of call center services for others; providing marketing services for real estate agents; providing real estate leads for prospective purchasers; matching consumers with professionals in the field of real estate; providing on-line referrals in the field of buying and selling real estate; Promotion of residential real estate property of others by offering real estate listing market analysis, comparison real estate property information, real estate property descriptions, real estate property prices, real estate property locations, real estate property area maps, and by providing information about local public transit, providing information about local neighborhood schools, providing information about local restaurants, providing information about local community centers, and providing information about local stores through an interactive website; operating online marketplaces for buyers and sellers of real estate services; market analysis and research in the fields of consumer lending, mortgages, and real estate; Marketing the insurance service of others; providing insurance leads for prospective customers; providing insurance agent referrals; providing lead generation for the sales

of automobiles, financial instruments and insurance; operating online marketplaces for buyers and sellers of insurance services.

### **Class 36**

(2) Financial services, namely, mortgage banking and lending services; origination, acquisition, servicing, securitization and brokerage of mortgage loans; Mortgage planning, financial planning and loan and mortgage refinancing services; loan financing, consumer lending services, and providing financial information on loans; financial services pertaining to personal financial accounts, daily monitoring of financial transactions and account balances, budget and spending loan financing, consumer lending, loan qualification and loan approval; financing of vehicles and vehicle loan services; commercial lending services; providing working capital financing to small businesses; student loan services; bill payment services; Electronic automated clearing house (ACH) processing services; cash management, namely, facilitating transfers of electronic cash equivalents; providing web-based, automated and customized personal financial management services, namely, user-directed management reporting; Financial consultation services provided to consumers in the fields of home and auto loans, mortgage and personal loans, as well as loan qualification and loan approval; Financial advice in the fields of home and auto loans, mortgage and personal loans, as well as loan qualification and loan approval; financial advice in the field of financial planning and financial management; financial investment services in the fields of securities, mutual funds, certificates of deposit, and portfolio management; investment consultation, investment brokerage and investment management service; credit card services; credit consulting services; credit information services, namely, providing credit information relating to consumer applicants for credit; issuing letters of credit; Providing information in the field of financial management, loans, credit scoring and credit management via a website; providing consumers with information about loans and information that lenders and others use to make credit decisions; Insurance and warranty insurance services; providing insurance underwriting warranty and extended warranty insurance contracts; third-party extended warranty services for vehicles; insurance underwriting and claims administration of extended motor vehicle service contracts for the repair and maintenance of motor vehicles; Providing information about real property listings, about the purchase and sale of residential real property, and about existing purchase and sale transactions of residential real property through an interactive website; Providing real estate management information that allows users to manage transaction documents and manage their property listing details, profiles and contact information via an interactive website; Providing real property information through an on-line computer database; Providing information in the field of real estate property listings, real estate property valuation, real estate financial analysis, and forecasts in the nature of housing-market performance through computer databases; real estate advisory services for carrying out the purchase and sale of residential real property and providing real estate financial transaction information; providing real estate valuation services, namely, real estate property assessment and creation of real property valuation reports for others for real estate valuation purposes; banking services; electronic banking via a global computer network; online banking services; online banking services accessible by means of downloadable mobile applications; savings bank services; savings account services; savings and loan services; on-line financial planning services, on-line checking account services, on-line savings account services; banking consultation; consumer lending services; bill pay services; bill payment services provided through a website; electronic payment, namely, electronic processing and transmission of bill payment data; providing electronic processing of electronic funds transfer, automated clearing house [ACH], credit card, debit card, electronic check and electronic payments; providing home equity lines of credit; merchant banking services; payment processing services, namely, credit card and debit card transaction processing services; providing personal

loans and lines of credit; financial services, namely, electronic remote check deposit services; providing information in the fields of banking and financial services; administering electronic disbursement of funds for others; financial planning and investment advisory services.

**Class 38**

(3) Providing access to a computer database in the field of real estate featuring searchable indexes of information namely real estate property listings, third-party web sites and links, and other resources available on computer networks.

**Class 42**

(4) Software as a service provider in the fields of real estate consultancy, consumer lending in the field of personal loans and home equity loans, mortgages and financing of business loans; providing temporary use of online non-downloadable software for use in transmitting payments, transferring funds, and bill payment; providing temporary use of online non-downloadable software for online banking, transaction management, financial planning, financial management, bill tracking and management, expense tracking and management, and financial goal tracking; providing temporary use of online non-downloadable software to allow users to perform electronic banking and financial transactions via a global computer network.



**Application Number** 1,987,865  
**Language of Application** English

**Filing Date** 2019-10-01

## APPLICANT AND AGENT DETAILS

### Applicant

2715729 Ontario Corp.  
29 Kron Dr  
Guelph  
ONTARIO  
N1G3B4

### Agent

D. MICHAEL BEAN  
(Michael Bean Trademark & Copyright Law), P.  
O. Box 1737, STN GALT, Cambridge,  
ONTARIO, N1R7G8

## TRADEMARK DETAILS

# THE DIRTY SEAHORSE

### Trademark Type

Standard Characters

### Services

#### Class 35

On-line retail store services featuring unisex apparel, kitchen ware, housewares, camp gear, cosmetics; Retail shops featuring unisex apparel, kitchen ware, housewares, camp gear, cosmetics.

**Application Number** 1,990,921  
**International Registration Number** 1492286  
**Language of Application** English

**Filing Date** 2019-09-06

## APPLICANT AND AGENT DETAILS

### Applicant

Ever Australia Pty Ltd  
Unit 1, 39 Hill Road  
Wentworth Point NSW 2127  
AUSTRALIA

### Agent

KENNETH R. CLARK  
(AIRD & BERLIS LLP), BROOKFIELD PLACE,  
SUITE 1800, 181 BAY STREET, TORONTO,  
ONTARIO, M5J2T9

## TRADEMARK DETAILS

# EVERAU

### Trademark Type

Standard Characters

### Goods

#### Class 25

Apparel being clothing, footwear and headgear, namely jackets, shoes and hats; footwear for sport; footwear parts, namely heels, outsoles, innersoles, insoles and soles of footwear; footwear uppers, namely, boot uppers and shoe uppers; infants' footwear; inserts for footwear other than orthopaedic inserts; pumps being footwear; soles for footwear; sporting footwear; athletics footwear; sports footwear; studs for sports footwear; thongs being footwear, namely thong sandals; tips for footwear; toe inserts for footwear other than orthopaedic; training shoes; boots (non-slip, non-reinforced); casual footwear; dance footwear; footwear for babies; footwear for children; footwear for dancing

**Application Number** 1,990,998  
**International Registration Number** 1481352  
**Language of Application** English

**Filing Date** 2019-09-27

## APPLICANT AND AGENT DETAILS

### Applicant

FLOW FUSHI Co., Ltd.  
4-1-28, Roppongi,  
Minato-ku  
Tokyo 106-0032  
JAPAN

### Agent

RIDOUT & MAYBEE LLP  
11 Holland Avenue, Suite 601 , Ottawa,  
ONTARIO, K1Y4S1

## TRADEMARK DETAILS

# Unframe The Beauty

### Trademark Type

Standard Characters

### Goods

#### Class 03

Hand soaps and laundry detergents; shampoos; body soaps; facial washes; cosmetics; hair rinses; hair conditioners; hair perming treatments; hair creams; perfumes; foundation; make-up powder; toilet water; milky skin lotions; cosmetic creams; cosmetic cleansing creams; sunscreen preparations; beauty serums; beauty gels; cosmetic concealers; lipsticks; lip glosses; lip creams; mascaras; eye shadows; eyeliner; gel eye patches for cosmetic purposes; beauty masks; bath salts, not for medical purposes; absorbent facial tissue; perfumery and fragrances; dentifrices

### Services

#### Class 35

Retail services and wholesale services for cosmetics, toiletries, dentifrices, soaps and detergents; retail services or wholesale services for pharmaceutical, veterinary and sanitary preparations and medical supplies; retail services and wholesale services for clothing; retail services and wholesale services for footwear, other than special footwear for sports; retail services and wholesale services for travel bags and pouches; retail services and wholesale services for personal articles namely false nails, false eyelashes, cotton wool for cosmetic purposes, cotton sticks for cosmetic purposes, eyelash curlers, pedicure sets, manicure sets, hair-removing tweezers, razor cases, shaving cases, cosmetic and toilet utensils, facial massage rollers for household purposes, eyelash brushes, eyelash combs, cosmetic brushes, make-up sponges, fitted vanity cases, hair brushes, combs, non-electric toothbrushes; retail services and wholesale services for woven fabrics and beddings; retail services and wholesale services for foods and beverages; retail services and wholesale services for furniture; retail services and wholesale services of home appliances including household saunas for beauty and sanitary purposes, facial saunas for household purposes, ultrasonic facial machines, facial steamers, hair dryers for household purposes, electric toothbrushes, electric irons, electric razors and hair clippers; retail services and wholesale services for bladed and pointed hand tools, hand tools and metal hardware fasteners; retail services and wholesale services for kitchen appliances, mops and brooms; retail services

and wholesale services for magazines; retail services and wholesale services for paper and stationery; retail services and wholesale services for sports goods; retail services and wholesale services for toys, dolls, video game machines and consoles; online retail services for downloadable and pre-recorded music and movies; retail services and wholesale services for clocks, watches and spectacles being eyeglasses and goggles; retail services and wholesale services for semi-wrought precious stones and their imitations; advertising the goods and services of others and advertising by transmission of on-line publicity for third parties through electronic communications networks; promoting the goods and services of others through the administration of sales and promotional incentive schemes involving trading stamps; business management analysis or business management consultancy; business management; marketing research and analysis; providing information relating to commercial business management; promoting the goods and services of others through advertisements on Internet websites; promoting the goods and services of others by preparing and placing advertisements in electronic magazines; import-export agency services; compilation of market statistics; providing and rental of advertising space on the internet ; providing advice relating to the analysis of consumer buying habits; providing business marketing news information on newspaper articles; rental of vending machines

**Application Number** 1,991,781  
**Language of Application** English

**Filing Date** 2019-10-23

## APPLICANT AND AGENT DETAILS

### Applicant

Clarity Clinical Skin Care Inc.  
3145 Old Conejo Road  
Newbury Park, CA 91320  
UNITED STATES OF AMERICA

### Agent

GOWLING WLG (CANADA) LLP  
SUITE 1600, 1 FIRST CANADIAN PLACE, 100  
KING STREET WEST, TORONTO, ONTARIO,  
M5X1G5

## TRADEMARK DETAILS

# RISE AND SHINE

### Trademark Type

Standard Characters

### Goods

#### Class 03

Adhesives for false eyelashes and nails; after sun creams; age spot reducing creams for cosmetic purposes; all-purpose cleaning preparations; anti-aging skin care preparations; beauty creams for body care; body and beauty care cosmetics; cosmetic creams, milks, lotions, gels and powders for the face, hands and body; cosmetic preparations against sunburn; cosmetics; cosmetics and make-up; deodorants for personal use; depilatory preparations and substances; essential oils for personal use; fragrances and perfumery; hand cleaning preparations; lip care preparations; makeup and cosmetics; massage oils and lotions; nail care preparations; non-medicated mouthwashes; non-medicated skin care preparations; perfumed creams; perfumed powders; perfumed soaps; perfumes; personal deodorants; skin care preparations; sun care preparations; sun-tanning preparations

**Application Number** 1,992,181  
**International Registration Number** 1486328  
**Language of Application** English

**Filing Date** 2019-10-07

## APPLICANT AND AGENT DETAILS

### Applicant

Honeywell International Inc.  
855 S. Mint St.  
Charlotte NC 28202  
UNITED STATES OF AMERICA

### Agent

ROBIC  
630, boul. René-Lévesque Ouest, 20e étage,  
Montréal, QUEBEC, H3B1S6

## TRADEMARK DETAILS

# HONEYWELL THE FUTURE IS WHAT WE MAKE IT

### Trademark Type

Standard Characters

### Foreign Character Translation

### Goods

#### Class 01

(1) Gases for sterilizing medical equipment, namely ethylene oxide; halogenated hydrocarbons for use as refrigerants and sold as such as chemicals of commerce; fluorinating chemical agent for use in the manufacture of pharmaceutical and agricultural products; oxime chemicals used as waterproofing masonry sealant; polymer compositions used in manufacturing semiconductor components; nylon resins; chemical solutions to be used as dopants in semiconductors; fluorinated solvents, namely degreasing and cleaning solvents; normally gaseous chemicals for use as propellants and dispersants, namely aerosol propellants; chemicals for use in agriculture, namely, diammonium sulfate, for use as an adjuvant in herbicides; sulfur containing nitrogen fertilizer for agricultural use; chemicals used for fumigation; chemical additives for use in the manufacture of container coatings and polyvinylchloride extrusion; polyethylene and ionomers used as a color enhancer in the manufacture of plastics and fibers; low molecular weight copolymers, namely ionic copolymers (ionomers) for use as a dispersion aid for pigments and as an additive for use as an aid in the processing of plastics; micronized polyethylene waxes for use in the manufacture of printing inks, surface coatings and cosmetics; polyethylene, and polyethylene derivatives; cyclohexanone, namely, organic liquid for use as a solvent for lacquers and paints.

#### Class 09

(2) Life-saving apparatus and equipment, namely, safety harnesses for fall prevention, safety gloves for protection against physical injury and x-rays for industrial purposes, safety helmets and face shields, safety footwear being protective footwear for the prevention of accident or injury, namely chemical exposure protective footwear; respiratory protection products, namely, air purifying respirators and rescue breathing apparatus, self-contained breathing apparatus for use by first responders, eye and face protection apparatus, namely safety goggles, protective eye glasses; protective glasses, and face shields, and electrical safety protective gear, namely, gloves, face shields, and hoods; personal and handheld gas detection systems and devices, namely

infrared sensors, calibrated glassware, LED displays; safety, security, protection and signaling devices, namely digital door locks, electronic control systems for room locking systems, emergency signal transmitters, signal amplifiers, and emergency public address systems comprised of speakers, amplifiers; electronic access control devices for controlling entry to buildings and/or restricted areas of buildings, namely electronic access control systems for interlocking doors; alarms and warning equipment, namely alarms for the detection of inflammable gases, anti-intrusion alarms, fire alarm systems, security alarms; alarms for buildings, namely, gas detectors, smoke detectors, intrusion detectors, fire alarms, water leakage alarms, and security detectors; electronic video surveillance apparatus, namely, cameras, including video cameras, display monitors and peripheral equipment, namely electric and electronic video surveillance installations, video surveillance cameras; signaling apparatus and instruments, namely, video surveillance cameras, recorders, and structural hardware and computer operating system and monitor software therefor; security control apparatus, namely, control panels for security alarms, electric control panels; security alarms; security warning apparatus, namely, building security alarms; control panels for security alarms; security alarm systems other than for vehicles comprised of intruder alarms, and fire/smoke alarms/detectors; wireless controllers for remotely monitoring and controlling the function and status of security systems; automatic access control apparatus for controlling entry to buildings and/or restricted areas of buildings, namely automatic controllers for revolving doors, facilities management software to control building environmental access and security systems; automatic and electric access control systems comprised of video cameras, video recorders and hardware and software used to operate these access control systems; electronic access control systems for interlocking doors comprised of electronic data readers, hardware and computer software therefore; electronic access control systems for buildings comprised of electronic data readers, hardware, and computer software therefor; remote control apparatus for opening and closing doors; motion and light sensors for security or access control systems or equipment; motion, glass break shock sensors, contact detectors for security or access control systems or equipment; computer and video monitors for security or access control systems or equipment; intrusion alarms for security or access control systems or equipment; electric control panels for security or access control systems and equipment; control panel housing for use with security or access control systems and equipment; keypads for use with security or access control systems and equipment; transceivers for security or access control systems or equipment; radio, data and wireless transmitters for security or access control systems and equipment; wireless, multi-protocol, digital and radio frequency signal receivers for security or access control systems and equipment; contact, magnetic, electronic and computerized alarm switches for security or access control systems and equipment; contact, magnetic, electronic and computer switch housing for security or access control systems and equipment; electrical power supply units for security or access control systems and equipment; transformers for security or access control systems or equipment; electronic magnetic contacts for security or access control systems and equipment; electronic switch plates for security or access control systems and equipment; electronic motion sensitive switches for security or access control systems and equipment; hardwire sirens; audio speakers for security or access control systems or equipment; electronic drivers in the nature of software operating systems for security or access control systems and equipment; electronic intrusion detectors for security or access control systems or equipment; electronic glass break sensors for security or access control systems and equipment; electronic vibration sensors for security or access control systems and equipment; electronic motion sensors for alarms, access control and alarm monitoring systems; fire protection and safety equipment, namely, air purifying respirators and rescue breathing apparatus; fire resistant clothing, namely, gloves, helmets, hoods, footwear; fire protection and safety equipment as components, or together as a system comprising one or more units in the nature of smoke detectors, fire detectors,

radio public address systems, water detectors, gas detectors for the sensing, detecting, monitoring, annunciation and reporting of smoke, hazardous gas, temperature, environmental conditions, frozen pipes, and water leakage; computer software for monitoring, controlling, and managing security, fire, and access control systems and devices; electronic key fobs being remote control apparatus and readers and encoders therefor; computer software for facilities management and controlling facility access systems and structural components therefor, namely facilities management software to control building environmental access and security system; surveillance equipment sold individually, as components, or together as a system, namely, video cameras and recorders, video hardware and video software for handling/processing/storing/transmission of video recordings; computer software for controlling and monitoring building systems in the nature of security, air conditioning, heating and lighting systems; communication control hardware, and video transmission devices, namely video cameras sold separately or as part of a system for operating closed circuit cameras; data storage devices and data transmission devices for use with security and surveillance systems, namely, high-speed storage subsystems for storage and backup of electronic data either locally or via a telecommunications network; tracking and control systems comprising one or more radio frequency identification tags, transceivers, and sensors used to determine and monitor the location and movement of tangible assets, inventory and individuals; respirators for non-medical use for protection against contaminants in air; self-contained breathing apparatus not for artificial respiration; protective spectacles; protective goggles; protective face shields against accidents, skin irritation and fire; welding helmets, being protective helmets; protective work headwear for protection against accidents or injury, namely, protective hats and caps being hard hats, bump caps, safety helmets; protective work clothing, in particular, hoods, jackets, pants, overalls, coats for protection against accident, skin irritation and fire; boots for protection against accident or injury; clothing for protection against accident, skin irritation and fire, namely chemical exposure protective clothing, clothing for protection against chemicals and radiation, clothing for protection against fire, clothing and gloves for use in welding for protection against accidents or injury, insulated clothing for protection against accidents or injury; footwear for protection against accidents, skin irritation and fire, namely chemical exposure protective footwear, fire protective footwear, boots and shoes for protection against accidents, safety boots; gloves for protection against accidents, skin irritation and fire, namely gloves for protection against x-rays for industrial purposes, fire-resistant gloves, gloves for protection against accidents; disposable gloves for laboratory use; safety restraints, other than for vehicle seats and sports equipment not for patients or for medical use, namely safety harnesses; safety harnesses other than for vehicles or sports purposes; workmen's safety harnesses being fall protection equipment for fall restraint and fall arrest; safety restraints being fall protection equipment for fall restraint and fall arrest, other than sports equipment; lanyards for safety purposes for fall protection; life belts and safety nets; gas detection and alarm systems, namely, gas detection control panels and gas sensors and detectors; downloadable or recorded software, namely facilities management software to control building environmental access and security systems; computer software for database management; computer software for use in managing and controlling production schedules, shipping schedules, purchase of materials, inventories and accounts in the fields of industrial and manufacturing processes; computer software for use in managing and controlling production schedules, shipping schedules, purchase of materials, inventories and accounts in the fields of commercial buildings; computer software for use in managing and controlling production schedules, shipping schedules, purchase of materials, inventories and accounts in the fields of aviation and transportation operations and facilities; security software.

## Services



**Class 38**

(1) Communication services, namely, electronic communication, long distance telephone communication services, telematic in-vehicle communication service providing wireless vehicle navigation and tracking; telecommunication services, namely, electronic mail; electronic communication services, namely, data communication by electronic mail; computerized communication services, namely, data communication by electronic mail; mobile communication services, namely telephone communication, personal communication services (PCS), mobile telephone communication; data communication services by electronic mail; transmission of information by satellite, internet, cloud and electronic data transmission, namely e-mail transmission services, cable television transmission services, recording, storage and subsequent transmission of voice and text messages by telephone; providing electronic telecommunication connection to a global computer network; communications via a global computer network or the internet, namely providing access to Internet chat rooms, providing access to an Internet discussion website; data transfer services, wired and wireless communication services via a global computer information network, namely providing access to a worldwide computer network; wired and wireless communication services via a global computer information network to view, control and manage alarm systems; transfer of data by wireless telecommunication, electronic mail to view, control and manage fire detection systems; transfer of data by wireless telecommunication, electronic mail to view, control and manage home and home building automation systems; transfer of data by wireless telecommunication, electronic mail to view, control and manage video cameras, namely provision of video conferencing services; transfer of data by wired and wireless communication services via a global computer information network to view, control and manage vehicle tracking systems, namely telematic in-vehicle communication service providing wireless vehicle navigation and tracking; transfer of data by wired and wireless communication services via a global computer information network to view, control and manage people tracking systems, namely telematic communication service providing wireless GPS tracking of people; transfer of data by wired and wireless communication services via a global computer information network to view, control and manage asset tracking systems, namely providing access to a global computer network for inventory management; transfer of data by wireless telecommunication, electronic mail to view, control and manage environmental controls, namely providing access to a global computer network for remote control and management of home heating, ventilation and air conditioning systems.

**Class 42**

(2) Consultation services for the development of cloud based computer software; cloud computing services, namely, server hosting, software as a service provider in the field of inventory management; platform as a service featuring computer software programs for database management, safety management of facilities and controlling facility access systems, controlling and monitoring building systems in the nature of security, air conditioning, hearing and lighting systems, connecting devices to software applications to manage and provide added software functionality to the devices, the transfer of information and user defined data, namely computer systems monitoring services; consultation in the field of cloud computing computer networks and software applications; providing temporary use of online non-downloadable operating system software for accessing and using a cloud computing network; providing technical advice relating to the design and development of computer hardware and software; technical support, namely, providing online software troubleshooting support services for computer program users; research and consultancy services relating to the design and development of computer hardware and computer software; software research, development, engineering and design; software development, programming and implementation; software as a service (SaaS) services, namely,

hosting software to manage service scheduling, billing, and the diagnosis and repair of fire alarm control panels, related accessories, and other in-building equipment; software as a service for use in database management, service scheduling, billing, diagnosis and repair pertaining to applications for fire alarm systems; software as a service for use in database management pertaining to applications for automation systems; hosting of computerized data for others, namely cloud computing provider services for general storage of data, data encryption and decoding services; providing information and advice about scientific research and analysis and preparation of technical reports with respect to industrial process controls, and home, building and environmental controls by means of a global computer network, namely providing information on the subject of home surveillance and security systems; technological consultation services, namely technological consulting services in the field of alternative energy generation; software as a service [SaaS], namely software as a service (SAAS) provider in the field of home surveillance and security systems; computer software technical support services and cloud computing services, namely technical support in the form of monitoring global computer network systems; rental, hire and leasing of computer hardware and software, namely rental of home security systems and safety alarms; consultancy and information services for the aforesaid services, namely computer programming consultancy, computer software consultancy; electronic data storage service, namely, providing remote storage of user's electronic and digital files and making them available to the user through a global communication network, namely cloud computing provider services for general storage of data; software as a service (SaaS) featuring software for use in connecting, controlling, securing, monitoring, automating, managing, maintaining, analyzing, optimizing, and ensuring the safety and enhancing the experience of industrial and manufacturing processes, assets and facilities, commercial buildings, utilities assets and facilities, aviation and transportation operations and facilities, cybersecurity systems and the related management of industrial and commercial workers and managers, namely software as a service (SaaS) provider in the field of home surveillance and security systems, data encryption, safety management of industrial work environments; platform as a service (PaaS) featuring computer software platforms for use in connecting, controlling, securing, monitoring, automating, managing, maintaining, analyzing, optimizing, and ensuring the safety and enhancing the user experience of industrial and manufacturing processes, assets and facilities, commercial buildings, utilities assets and facilities, aviation and transportation operations and facilities, cybersecurity systems and the related management of industrial and commercial workers and managers, namely platform as a service (PaaS) provider in the field of home surveillance and security systems, data encryption, safety management of industrial work environments.

### **Claims**

Priority Filing Date: April 24, 2019, Country or Office: Benelux Office for IP (BOIP), Application No: 1394566 in association with the same kind of goods and in association with the same kind of services

**Application Number** 1,992,264  
**Language of Application** English

**Filing Date** 2019-10-24

## APPLICANT AND AGENT DETAILS

### Applicant

Northern Innovations Holding Corp.  
381 North Service Road West  
Oakville  
ONTARIO  
L6M0H4

### Agent

JO-ANN M. HEIKKILA  
37 Dawnridge Trail, Brampton, ONTARIO,  
L6Z1Z8

## TRADEMARK DETAILS

# YUMOJIS

### Trademark Type

Standard Characters

### Goods

#### Class 30

Protein based snack food, namely, protein bars, protein balls, and protein wafers

**Application Number** 1,992,737  
**Language of Application** English

**Filing Date** 2019-10-28

## APPLICANT DETAILS

### Applicant

Aalto Development Inc.  
140 Dunlop St E  
Unit 104  
Barrie  
ONTARIO  
L4M6H9

## TRADEMARK DETAILS

### Trademark Type

Design

### Visual Representation



L Ā K H O U S

LAKEFRONT RESIDENCES

**Colour Claim**

Colour is claimed as a feature of the trademark. LAKHOUSE appears in grey. LAKEFRONT RESIDENCES appears in navy blue. L-icon appears having white L in a navy blue rectangle box. More specifically, the L-icon is located in the left part of the navy blue rectangle box.

**Services****Class 36**

(1) real estate investment; real estate management

**Class 37**

(2) real estate development

**Application Number** 1,993,570  
**International Registration Number** 1330520  
**Language of Application** English

**Filing Date** 2019-09-17

## APPLICANT AND AGENT DETAILS

### Applicant

Focusrite Audio Engineering Limited  
Windsor House, Turnpike Road  
High Wycombe, Buckinghamshire HP12 3FX  
UNITED KINGDOM

### Agent

TORYS LLP  
SUITE 3000, 79 WELLINGTON ST. W., BOX  
270, TD CENTRE, TORONTO, ONTARIO,  
M5K1N2

## TRADEMARK DETAILS

# NOVATION

### Trademark Type

Standard Characters

### Goods

#### Class 09

(1) Computer hardware for creating, editing, recording, transmitting, and reproducing music, sounds and digital images, and for controlling and improving audio equipment sound quality, and containers and bags for use with all of the aforesaid goods, and parts, fittings and accessories for all of the aforesaid goods, downloadable computer software for creating, editing, recording, transmitting, and reproducing music, sounds and digital images, and for controlling and improving audio equipment sound quality, computer software for creating, editing, recording, transmitting, and reproducing music, sounds and digital images; musical instrument digital interface controllers and converters for triggering and transmitting data to digital instrument interface-enabled devices, and containers and bags for use with all of the aforesaid goods, and parts, fittings and accessories for all of the aforesaid goods; musical instrument digital interface software for triggering and transmitting digital audio recordings to musical instrument digital interface controllers being audio interfaces; downloadable music files; downloadable mobile phone ringtones; digital music downloadable from a computer database and the internet; music composition software; audio over IP network equipment, namely, audio interfaces to transport and convert signals to and from the digital audio networking format, and containers and bags for use with all of the aforesaid goods, and parts, fittings and accessories for all of the aforesaid goods; computer network interface devices, namely, modems, computer interface cards, computer interface boards, high definition multimedia interface cables for transmitting and recording music and audio to a computer, and containers and bags for use with all of the aforesaid goods, and parts, fittings and accessories for all of the aforesaid goods; downloadable electronic publications, namely magazines, newsletters, articles in the fields of music and audio products; downloadable computer game programs; audio electrical and electronic apparatus and instruments, namely, audio amplifiers, audio speakers, audio receivers, audio cables, connector cables, digital audio tape players, audio cassette players, computer interface boards, high definition multimedia interface cables, audio pre-amplifiers, audio tape recorders, audio cassette recorders, digital audio equalizers, outboard audio processing equipment, namely two-channel equalizers, parametric, semi-parametric, graphic, peak, and program equalizers, limiters and compressors, computers, laptops, tablet computers, smart

phones, docking stations for computers, laptops, tablet computers, smart phones and telecommunications apparatus for recording, transferring and transmitting video and sound, microphones, sound amplifiers, microphone pre-amplifiers, stereo pre-amplifiers, computer peripheral devices, namely, speakers, loudspeakers, horns for loudspeakers, headphones, electric cables and wires, pre-recorded magnetic data carriers and optical data carriers, namely CDs, DVDs, CD-ROMs featuring music, record players, video tape recorders, portable DVD players, cameras for photography, acoustic conduits, cabinets for use with loudspeakers, diaphragms for acoustics, namely audio speakers, acoustic couplers, audio and video receivers, Network communication devices, namely, audio interfaces for transporting and aggregating data across multiple network infrastructures and communication protocols, electronic sound synthesizers, dictating machines, hemline markers, voting machines, electronic weighing scales for kitchen use, electronic weighing scales for personal use, radios, televisions, eyeglasses, video and television screens, MIDI (Musical Instrument Digital Interface) controllers other than musical instruments, and containers and bags for use with all of the aforesaid goods, and parts, fittings and accessories for all of the aforesaid goods; money counting and sorting machines, electronic tags for goods; photographic, electrostatic and thermic photocopiers; surveying instruments, level measuring machines for surveying; materials for electricity mains, namely wires and cables; electronic connections, namely plugs, sockets; remote controls for audio amplifiers, remote controls for audio interfaces, remote controls for audio mixers, remote controls for audio signal processors; integrated circuits; semi-conductors; optical fibres, namely light conducting filaments; electric remote control installations for audio equipment; rods, namely lightning conductors; fire extinguishers; batteries and battery chargers for mobile telephones and notebook computers; exposed x-ray films; egg-candlers; dog whistles; decorative magnets; electrified fences.

**Class 15**

(2) Musical instruments, namely, musical keyboards, sheet music and musical instrument stands, musical instrument cases, musical boxes, music synthesizers, electronic background music machines, namely keyboard instruments, synthesizers, digital drums and percussion instruments in the nature of electronic musical keyboards incorporating musical instrument data interface (MIDI) controllers to generate sound, musical instruments controlled by computer, electronically operated computer controlled musical instruments, and parts, fittings and accessories for all the aforesaid goods.

**Application Number** 1,993,644  
**International Registration Number** 1150593  
**Language of Application** English

**Filing Date** 2019-10-16

## APPLICANT AND AGENT DETAILS

### Applicant

Scotwork Limited  
7 Fortrose Street  
Glasgow G11 5NU  
UNITED KINGDOM

### Agent

WILSON LUE LLP  
250 University Avenue, 5th Floor, Toronto,  
ONTARIO, M5H3E5

## TRADEMARK DETAILS

# SCOTWORK

### Trademark Type

Standard Characters

### Goods

#### Class 09

(1) Electronic publications, namely, brochures, whitepapers, newsletters, downloadable educational course materials, aptitude assessment tests, blog articles, magazines, information pamphlets, journals, books and directories, in the field of negotiations; computer programs for use as searching directories; interactive computers for use in training; interactive computer software for use in training in the field of negotiations; educational software containing topics of instruction in negotiations; downloadable digital content being videos containing information in the field of negotiations; downloadable digital audio recordings featuring training in the field of negotiations; pre-recorded videotapes, audio cassettes, compact discs and DVDs, containing information in the field of negotiations; laser discs containing information in the field of negotiations, phonographic records; downloadable radio podcasts; vodcasts, namely, downloadable video casts containing information in the field of negotiations.

#### Class 16

(2) Paper, cardboard; printed publications in the field of negotiations; printed forms, charts and diagrams, in the field of negotiations; manuals; printed training guides in the field of negotiations; magazines in the field of negotiations; newspapers in the field of negotiations; journals in the field of negotiations; books in the field of negotiations; newsletters in the field of negotiations; advertisements and promotional materials, namely, signs of paper and cardboard, in the field of negotiations; directories, pamphlets, leaflets and brochures in the field of negotiations; photographs; pictures; posters; pens; pencils; paper stationery; works of art, namely, art pictures, art prints, framed artwork; posters; pictures; writing instruments; artists' brushes, palettes, pastels, pencils and pens; stickers and transfers; stickers; greeting cards; postcards; scrapbook albums; diaries; calendars; wall charts, namely, instructional charts in the field of negotiations; manuals for business training courses in the field of negotiations; year books; handbooks in the field of negotiations; periodicals in the field of negotiations; prospectuses in the field of negotiations; catalogues in the field of negotiations.

### Services



**Class 41**

Educational, instructional and teaching services, in the field of negotiations; organisation and running of training courses in the field of negotiations; publication of books and printed matter; publishing of electronic publications, namely, brochures, whitepapers, newsletters, course materials, aptitude assessment tests, blog articles, magazines, information pamphlets, journals, books and directories, in the field of negotiations; assessment of skills, namely, performance measurement evaluations in the field of negotiations; mentoring services, namely, coaching in the field of negotiations.

**Application Number** 1,993,669  
**Language of Application** English

**Filing Date** 2019-11-01

## APPLICANT AND AGENT DETAILS

### Applicant

Norman Mark Brown  
174195 Lower Valley Rd  
Markdale  
ONTARIO  
N0C1H0

### Agent

WITMART INC.  
34 King Street East, Suite 500, Toronto,  
ONTARIO, M5C2X8

## TRADEMARK DETAILS

# BEAVER VALLEY MAPLE

### Trademark Type

Standard Characters

### Goods

#### Class 30

Maple syrup; Maple-based spread

**Application Number** 1,995,436  
**Language of Application** English

**Filing Date** 2019-11-13

## APPLICANT DETAILS

### Applicant

Jeffrey Paches  
426 Butchart Drive NW  
Edmonton  
ALBERTA  
T6R1R1

## TRADEMARK DETAILS

### Trademark Type

Design

### Visual Representation



### Colour Claim

Colour is claimed as a feature of the trademark. Word Egg is light yellow with black outline Word Right is golden yellow with black outline Egg logo is golden yellow with black outline Egg logo has a green check-mark with black outline

### Goods

#### Class 21

cooking utensils

**Application Number** 1,998,834  
**Language of Application** English

**Filing Date** 2019-12-02

## **APPLICANT AND AGENT DETAILS**

### **Applicant**

Thriftys Inc. (2005)  
50 Dufflaw Road  
Toronto  
ONTARIO  
M6A2W1

### **Agent**

DICKINSON WRIGHT LLP  
199 Bay Street, Suite 2200, P.O. Box 447,  
Commerce Court : Postal Station, Toronto,  
ONTARIO, M5L1G4

## **TRADEMARK DETAILS**

### **Trademark Type**

Design

### **Visual Representation**

**thrift**

**Services****Class 35**

Operation of retail stores dealing in clothing and fashion accessories, namely, jewelry, handbags, headwear, namely hats, belts, scarves, carry-all bags, sunglasses, perfume, cologne; online sales of clothing and fashion accessories, namely, jewelry, handbags, headwear, namely hats, belts, scarves, carry-all bags, sunglasses, perfume, cologne.

**Application Number** 2,001,191  
**Language of Application** English

**Filing Date** 2019-12-13

## APPLICANT AND AGENT DETAILS

### Applicant

LG H&H Co., LTD.  
58, Saemunan-ro, Jongno-gu  
Seoul,  
REPUBLIC OF KOREA

### Agent

BORDEN LADNER GERVAIS LLP  
World Exchange Plaza, 100 Queen Street,  
Suite 1300, Ottawa, ONTARIO, K1P1J9

## TRADEMARK DETAILS

# SAFFRON

### Trademark Type

Standard Characters

### Goods

#### Class 03

(1) Fabric softeners for laundry use; laundry detergents for household use; bleaching preparations for laundry use; bleaching preparations for household use; dry-cleaning preparations; detergents for kitchen purposes; dishwasher detergents

#### Class 05

(2) Fabric deodorizers; deodorants for clothing; deodorizers for household pet litter boxes; household deodorants, namely, room deodorizing compositions; air deodorizers; air deodorizer sprays; air deodorising preparations; all purposes deodorizing preparations, namely, deodorants for bidet (not for industrial purposes); deodorants, other than for human beings or for animals, namely, deodorants for clothing, shoes and textiles, deodorizers for shoes, all purpose deodorizing preparations, room deodorizing compositions, room deodorants, deodorizers for garbage disposals, deodorizers for litter trays, deodorizing preparations for pet litter boxes, automobile deodorizers, carpet deodorizers

**Application Number** 2,001,192  
**Language of Application** English

**Filing Date** 2019-12-13

## APPLICANT AND AGENT DETAILS

### Applicant

LG H&H Co., LTD.  
58, Saemunan-ro, Jongno-gu  
Seoul,  
REPUBLIC OF KOREA

### Agent

BORDEN LADNER GERVAIS LLP  
World Exchange Plaza, 100 Queen Street,  
Suite 1300, Ottawa, ONTARIO, K1P1J9

## TRADEMARK DETAILS

# SAFFRON AURA

### Trademark Type

Standard Characters

### Goods

#### Class 03

(1) Fabric softeners for laundry use; laundry detergents for household use; bleaching preparations for laundry use; bleaching preparations for household use; dry-cleaning preparations; detergents for kitchen purposes; dishwasher detergents

#### Class 05

(2) Fabric deodorizers; deodorants for clothing; deodorizers for household pet litter boxes; household deodorants, namely, room deodorizing compositions; air deodorizers; air deodorizer sprays; air deodorising preparations; all purposes deodorizing preparations, namely, deodorants for bidet (not for industrial purposes); deodorants, other than for human beings or for animals, namely, deodorants for clothing, shoes and textiles, deodorizers for shoes, all purpose deodorizing preparations, room deodorizing compositions, room deodorants, deodorizers for garbage disposals, deodorizers for litter trays, deodorizing preparations for pet litter boxes, automobile deodorizers, carpet deodorizers

**Application Number** 2,001,948  
**International Registration Number** 1504727  
**Language of Application** English

**Filing Date** 2019-06-27

## APPLICANT AND AGENT DETAILS

### Applicant

Schwarz Zentrale Dienste KG  
Stiftsbergstr. 1  
74172 Neckarsulm  
GERMANY

### Agent

ROBIC  
630, boul. René-Lévesque Ouest, 20e étage,  
Montréal, QUEBEC, H3B1S6

## TRADEMARK DETAILS

**Trademark Type**

Design

**Visual Representation**







### Colour Claim

Colour is claimed as a feature of the trademark. The wording "RESET PLASTIC" is gray, the circle surrounding the wording has a gray beginning and tail end on the left, the right side of the circle is split into five different sections, appearing from top to bottom in light green, turquoise, dark green, light blue, and dark blue.

### Goods

#### Class 01

(1) Unprocessed plastics in the form of powders, gel, masses, liquids, pellets, granules, emulsions, chips and masses; unprocessed artificial plastics; polyurethanes; additives (chemical -) for plaster.

#### Class 16

(2) Plastic, cardboard and paper sheets, films and bags for wrapping, storage and packaging; bags of plastics for lining refuse bins; plastic food storage bags for household use; extendible plastic cling film for food wrapping; food wrapping plastic film; plastic cling film, extensible, for palletization; plastic envelopes; plastic food wrap; plastic materials for packaging, namely bags and films; bags of plastics for lining refuse bins.

#### Class 17

(3) Raw and semi-worked rubber, gutta-percha, gum, asbestos, mica; plastics and resins in extruded form for use in manufacturing processes; insulating covers for industrial machinery; masking films; semi-worked acrylic molded substances; recycled plastic rods and bars; semi-processed plastics; semi-finished foils of plastics for insulation; plastic laminated sheets and panels for the manufacture of countertops and tabletops; plastic material in extruded form for use in production; foils of plastics used as packing, stopping and insulating materials; shock-absorbing, vibration dampers and packing materials namely foils of plastics, cushioning materials of rubber and plastics, stuffing materials of rubber and plastics; adhesive tapes and bands for industrial purposes, namely packaging; sealing strips made of plastics for doors and windows; semi-processed foams and films of plastics used as filtering materials.

#### Class 20

(4) Packaging containers of plastic for storage and transport; Packaging containers of plastic, plastic closures for packaging containers and plastic holders for packaging containers; plastic furniture casters; boxes made of plastic; clips of plastic for sealing bags; plastic storage drums; plastic trays [containers] used in food packaging; receptacles of plastic for storing goods for transportation, namely plastic storage bins; protective containers of plastic for packing goods; bamboo baskets for industrial purposes; barrels and casks, non-metallic; plastic lids for cans; screw caps, not of metal; sealing caps, not of metal; crates and pallets, non-metallic; transport pallets, not of metal; plastic furniture knobs; fasteners, non-metallic; clips made of plastics for cables; threaded fasteners made of plastic.

**Class 21**

(5) Household or kitchen containers, namely beverage containers, garbage containers, thermal insulated containers for food or beverages; household or kitchen utensils, namely cooking utensils, graters for kitchen use, kitchen scrubbing brushes; tableware and cookware, except forks, knives and spoons, namely cooking pots, pots and pans, table glassware, crockery; Plastic containers namely, mugs made of plastic, plastic food storage containers for household and domestic use, lunch boxes made of plastic, plastic drinking straws, plastic coasters; cups made of plastics; plastic plates; plastic ice buckets; mop wringer buckets; planters of plastic; plastic dust bins; plastic bottles; plastic bowls [basins]; reusable plastic water bottles sold empty.

**Services****Class 35**

(1) Public relations services; product demonstrations and product display of home furniture, household kitchen utensils and cookware; trade show and commercial exhibition services, namely arranging and conducting trade show exhibitions for toys, fitness equipment and automobiles; loyalty, incentive and bonus program services, namely administration of consumer loyalty, credit card reward program services, administration of loyalty rewards programs featuring trading stamps, travel reward programs; distribution of advertising, marketing and promotional material, namely distributing coupons of others, distributing leaflets, brochures and printed matter of others; advertising, marketing and promotional consultancy, advisory and assistance services namely business advice relating to advertising, business advice relating to marketing, providing advertising space on the internet, on billboards, in periodicals, newspapers, and magazines; promoting the goods and services of others through advertisements on Internet websites, through infomercials, by distributing coupons, rental of advertising space; marketing studies; collection and systematization of business data, namely business management services relating to information and data compiling and analyzing; business management consultancy and advisory services; market research and marketing studies; development of advertising and marketing concepts and strategies for others; professional business consulting related to waste and recycling management; business administration; office functions, namely photocopying services, preparing mailing lists; business analysis, research and information services related to waste and recycling management; business administration assistance, management and administrative services; cost price analysis regarding waste disposal, removal, handling and recycling; consultancy services relating to the procurement of goods and services, namely consultancy services in the field of import and export; goods or services price quotations, namely cost-price analysis; providing consumer product and service information in the field of waste disposal, removal, handling and recycling; commercial information and advice for consumers in the field of waste disposal, removal, handling and recycling; collection of environmental information for promoting public awareness of environmental issues and initiatives.

**Class 37**

(2) Building construction; building, construction and demolition of building; construction and demolition services, namely rental of tools, plant and equipment for construction and demolition; extraction of natural resources namely, mining extraction, oil and gas drilling; cleaning services of waste crushing machines and apparatus; maintenance services of waste storage facilities; installation of waste storage facilities; installation and repair of electric home appliances; installation of industrial machinery, namely waste crushing machines, plastic processing machines; repair and maintenance of plastic processing machines and apparatus; providing information relating to the repair and maintenance of plastic processing machines and apparatus; providing information relating to the repair or maintenance of waste crushing machines and apparatus;

waste disposal, namely , septic tank pumping and cleaning; repair and maintenance of waste compacting machines and apparatus; refuse collection services; repair of transport containers; repair of ironmongery, namely architectural hardware; maintenance and repair of storage tanks; repair of industrial waste treatment machines; repair and maintenance of fork lift trucks, telehandlers, trash handlers and garbage trucks and apparatus; repair and maintenance of transport and packaging containers of metal; repair and maintenance of waste bins [skips] of metal for industrial use; repair and maintenance of scaffolding of metal, metal storage shelters, portable mobile metal office buildings, metal canopies, metal partitions for building, metal structures with flexible covers for commercial or industrial storage; repair and maintenance of metal pallets; repair and maintenance of packaging containers of plastic, plastic closures and plastic closures for packaging containers; repair and maintenance of crates and pallets, non-metallic.

### **Class 39**

(3) Cargo ship and truck transport; packaging and warehouse storage of goods for others; storage of refuse; transportation of waste; removal of waste, namely garbage collection services; hire of waste storage containers; collection of commercial waste; collection and transport of electronic scrap, namely garbage collection services; tracking and tracing of shipments; paper and cardboard collection for recycling; consultancy services relating to freight transportation by air, boat, rail and truck; services for the arranging of transportation namely supply chain logistics and reverse logistics services for the transportation of goods for others by air, rail, ship or truck; bulk warehouse storage; hire of pallet cages; providing information relating to warehousing services; providing information relating to the rental of warehouse space; rental of recycling containers; rental of means of freight transportation, namely cargo ships and trucks; garbage collection [trash pickup only]; collection of containers for commercial waste.

### **Class 40**

(4) Recycling of waste; providing information relating to the rental of waste crushing machines and apparatus; providing information relating to the rental of waste compacting machines and apparatus; glass recycling services; rental of waste crushing machines and apparatus; rental of waste compacting machines and apparatus; destruction of waste and trash; destruction of trash; sorting of waste and recyclable material; treatment and recycling of plastic packaging; staining of textile, leather and fur; consultancy relating to the recycling of waste and trash; incineration of waste and trash; consultancy relating to the incineration of waste and trash; consultancy relating to the destruction of waste and trash; treatment [reclamation] of material from waste, namely waste sorting services.

### **Class 42**

(5) Industrial design analysis and research services in the field of waste recycling; scientific and technological services, namely scientific research, analysis and testing in the field of waste recycling, scientific and technological research and design relating thereto in the field of waste recycling; research and development of new products for third parties in the field of plastic materials; research relating to waste analysis; provision of information, advice and consultancy in relation to carbon offsetting; engineering services in the field of environmental technology; engineering services in the field of waste recycling; engineering services in the field of building technology; scientific research in the field of natural science related to waste recycling; scientific research in the field of earth science related to waste recycling; environmental monitoring of waste treatment areas; environmental monitoring of waste storage areas; advisory services relating to pollution control; research in the field of environmental protection; environmental testing and inspection services related to waste recycling; technical consulting in the field of environmental engineering; advisory services relating to environmental pollution; technical consultancy in the field

of environmental science; design of laboratories for the biotechnology industry; computer aided part and mould design services related to packaging and wrapping materials; packaging design; designing of packaging and wrapping materials; design of dumpsters for the transportation of waste.

**Claims**

Priority Filing Date: December 27, 2018, Country or Office: EUIPO (EU), Application No: 018004726 in association with the same kind of goods and in association with the same kind of services

**Application Number** 2,004,165  
**International Registration Number** 1506791  
**Language of Application** English

**Filing Date** 2019-10-31

## APPLICANT AND AGENT DETAILS

### Applicant

Spandex Limited  
1600 Park Avenue, Aztec West  
Almondsbury, Bristol BS32 4UA  
UNITED KINGDOM

### Agent

BORDEN LADNER GERVAIS LLP  
Bay Adelaide Centre, East Tower, 22 Adelaide  
St. West, TORONTO, ONTARIO, M5H4E3

## TRADEMARK DETAILS

### Trademark Type

Design

### Visual Representation



### Services

#### Class 35

(1) Wholesale store services, retail services, online wholesale services, online retail services, wholesale services via a distributorship, retail services via a distributorship, online wholesale services by a distributorship and online retail services via a distributorship, all the aforementioned services featuring vinyl films and vinyl foils and self-adhesive vinyl films and vinyl foils for use in sign making and vehicle-wrapping, coloured vinyl films, printable self-adhesive vinyl films, self-adhesive films for application to vehicles, films for architectural and interior decor purposes, namely, decorative films and protective films for application to internal and external walls, floors, and windows, and blackboard and whiteboard films, decorative films and protective films for application to furniture (including built in furniture) and furnishings, films for application to glass, namely, glass safety and protection films, sun control films, and privacy films, and self-adhesive tapes for use in sign making; wholesale store services, retail services, online wholesale services, online retail services, wholesale services via a distributorship, retail services via a distributorship, online wholesale services by a distributorship and online retail services via a distributorship

services, all the aforementioned services featuring application tapes and adhesive tapes for signmaking, cleaning materials, namely cleaning cloths and pads, surface cleaners, and spray bottles, adhesive film removing products, adhesive removing products, vinyl removing products, heat guns, cutting tools namely knives, scalpels, and blades, measuring tools namely laser measuring device to measure existing signs for replacement or maintenance or to measure areas for new sign placement, sealants, eyelet presses, welding machines for plastics materials, squeegees, rollers, gloves, ink, ink cartridges, paper, laminating materials namely overlamine films and liquid overlaminates, plotters, printers, routers, namely machine tools, banner system units and sign system units; wholesale store services, retail services, online wholesale services, online retail services, wholesale services via a distributorship, retail services via a distributorship, online wholesale services by a distributorship and online retail services via a distributorship, all the aforementioned services featuring composite materials comprising predominantly plastics material and also metal, non-metallic building and construction materials, predominantly non-metallic building and construction materials, non-metallic building materials, predominantly non-metallic building materials for making signs and information and advertising displays; wholesale store services, retail services, online wholesale services, online retail services, wholesale services via a distributorship, retail services via a distributorship, online wholesale services by a distributorship and online retail services via a distributorship, all the aforementioned services featuring nameplates, number plates, placards of wood, placards of plastics, signboards of wood, signboards of plastics, decorative and art materials and media materials, namely canvas materials and inkjet papers and inkjet films for wall decoration and interior decor, fabrics, curtains, wall hangings, tablecloths, fabrics for manufacturing tents, textile materials (including those that are self-adhesive) for use in the manufacture of blinds, floor coverings and wallpaper, textile materials (including those that are self-adhesive) for use in sign making, graphics, advertising media, interior decor applications, curtains, upholstery and soft furnishings; providing information and advice to consumers regarding the selection and purchasing of materials used in sign making; advertising and business management consultancy services, advertising the goods and services of others, production of advertising materials for others; retail and wholesale services via a distributorship featuring the sale of sign making apparatus, and supplies for use with sign making apparatus.

#### **Class 42**

(2) Technical support advisory services in the field of sign making, sign design, and the graphic arts industries, namely, troubleshooting in the nature of diagnosing problems with digital sign making and wide format printing equipment, and related technical support advisory and consulting services.

**Application Number** 2,005,381  
**International Registration Number** 1219539  
**Language of Application** English

**Filing Date** 2019-12-19

## APPLICANT AND AGENT DETAILS

### Applicant

Shivom Enterprises Pty Ltd  
27/323 Woodpark Road  
SMITHFIELD NSW 2164  
AUSTRALIA

### Agent

JOHN H. SIMPSON  
(SHIFT LAW PROFESSIONAL  
CORPORATION), 60 St. Clair Ave. East, Suite  
403, Toronto, ONTARIO, M4T1N5

## TRADEMARK DETAILS

### Trademark Type

Design

### Visual Representation



**Goods**

**Class 29**

(1) Drinks flavoured with spices and having a base of milk; deep frozen vegetables; frozen vegetables; mixed pickles; pickle relish; pickled cucumbers; pickled fruit; pickled gherkins; pickled onions; pickled peppers; pickled vegetables; pickles; pickles, namely, relishes; sweet pickle, namely, pickled fruit; sweet pickle, namely, pickled vegetables; cocoa butter; prepared meals consisting primarily of cooked fruits and vegetables, namely, curry stew; salted nuts; desserts made from milk products, namely, milk shakes; foods made from milk products, namely, buttermilk, milk, curd, milk powder, cheese, and clarified butter; clarified butter, namely, ghee; milk products; edible oils; deep frozen foods, namely, frozen vegetables, frozen fruits, and pre-cooked curry stew; vegetarian frozen foods consisting primarily of vegetable; processed edible seeds; processed seeds prepared for human consumption; processed prepared seeds; prepared snacks made from dried fruit; prepared snacks made from dried vegetables; prepared snacks made from nuts; sweet corn-based snack food

### **Class 30**

(2) Curry spices; pizza spices; spices; coffee; flavourings made from pickles; condiments, namely, sweet pickle relish; sago; apple flavoured tea; chai tea; fruit tea other than for medicinal purposes; herbal tea other than for medicinal purposes; iced tea; tea, namely, mate; non-medicated tea bags; orange flavoured tea other than for medicinal use; tea; cocoa; cocoa products, namely, fresh cocoa pulp juice, cocoa spreads, cocoa powder, cocoa beverages with milk, cocoa mix, and prepared cocoa and cocoa-based beverages; rice; rice crackers; rice flour; prepared wild rice; corn flour; flour; flour for food; flour mixes; flour of millet; food products containing flour, namely, roti, bread, naan bread, flour-based gnocchi; maize flour; snack food products made from maize flour; snack food products made from rice flour; snack food products made from soya flour; snack foods prepared from potato flour; soya flour; wheat flour; salt for cooking; sea salt for cooking; mustard; confectionery, namely, gum paste, cake, table syrups, sweet pastries, cookies, and sugar candies; dairy confectionery; sauce mixes; hot sauce; hot sauce, namely, spicy sauces; tomato based sauces; sugar; sugar coated peanuts; sugared almonds; sesame seeds; pastry; puff pastry; prepared snacks for human consumption made from cereals; sesame snacks; curry spice powder; prepared curry sauce; curry paste; curry powder; curry sauces; curry spices

### **Class 31**

(3) Berries, fresh fruits; sugarcane; unprocessed grains, namely, seeds; fresh vegetables; fresh vegetables, namely, onions.



**Application Number** 2,005,552  
**Language of Application** English

**Filing Date** 2020-01-09

## APPLICANT AND AGENT DETAILS

### Applicant

For Life Products, LLC  
2301 SW 145th Avenue  
Miramar, FL 33027  
UNITED STATES OF AMERICA

### Agent

GOWLING WLG (CANADA) LLP  
SUITE 1600, 1 FIRST CANADIAN PLACE, 100  
KING STREET WEST, TORONTO, ONTARIO,  
M5X1G5

## TRADEMARK DETAILS

### Trademark Type

Design

### Visual Representation



### Goods

#### Class 01

(1) chemical preparations for protecting leather; chemical preparations for protecting vinyl; chemical preparations to be applied to boat for preventing UV light damage; chemical preparations to be applied to plastics for preventing UV light damage; chemical preparations to be applied to textiles for preventing UV light damage; chemical preparations to prevent mildew; chemical preparations to repel water for boat use; chemical preparations to repel water from fabrics; chemical preparations to repel water from leather; fabric protectants for carpets; fabric protectants for fabric seats; fabric protectants for leather; fabric protectants for leather seats; fabric protectants for textiles; fabric protectants for vinyl seats; leather-waterproofing chemicals;

#### Class 03

(2) all purpose cleaning preparations; all-purpose boat polish; cleaners for marine bilge pumps; cleaning agents for metal; cleaning preparations for boat use; cleaning preparations for fiberglass; cleaning preparations for leather; cleaning preparations for vinyl; creams for leather; degreasers for cleaning boats; degreasers for marine bilge pumps; fabric stain removers; leather polishes; polishes for vinyl seats; polishing creams for vinyl seats; polishing wax for leather; polishing wax for vinyl; soap for boat use;

#### Class 05

(3) chemical preparations to treat mildew; deodorizers for boats; deodorizers for fish boxes;

### Claims

Priority Filing Date: July 09, 2019, Country or Office: UNITED STATES OF AMERICA, Application No: 88506159 in association with the same kind of goods (1); July 09, 2019, Country or Office: UNITED STATES OF AMERICA, Application No: 88506159 in association with the same kind of goods (3); July 09, 2019, Country or Office: UNITED STATES OF AMERICA, Application No: 88506159 in association with the same kind of goods (2)

**Application Number** 2,005,553  
**Language of Application** English

**Filing Date** 2020-01-09

## APPLICANT AND AGENT DETAILS

### Applicant

For Life Products, LLC  
2301 SW 145th Avenue  
Miramar, FL 33027  
UNITED STATES OF AMERICA

### Agent

GOWLING WLG (CANADA) LLP  
SUITE 1600, 1 FIRST CANADIAN PLACE, 100  
KING STREET WEST, TORONTO, ONTARIO,  
M5X1G5

## TRADEMARK DETAILS

# REJUVENATE MARINE

### Trademark Type

Standard Characters

### Goods

#### Class 01

(1) chemical preparations for protecting leather; chemical preparations for protecting vinyl; chemical preparations to be applied to boat for preventing UV light damage; chemical preparations to be applied to plastics for preventing UV light damage; chemical preparations to be applied to textiles for preventing UV light damage; chemical preparations to prevent mildew; chemical preparations to repel water for boat use; chemical preparations to repel water from fabrics; chemical preparations to repel water from leather; fabric protectants for carpets; fabric protectants for fabric seats; fabric protectants for leather; fabric protectants for leather seats; fabric protectants for textiles; fabric protectants for vinyl seats; leather-waterproofing chemicals;

#### Class 03

(2) all purpose cleaning preparations; all-purpose boat polish; cleaners for marine bilge pumps; cleaning agents for metal; cleaning preparations for boat use; cleaning preparations for fiberglass; cleaning preparations for leather; cleaning preparations for vinyl; creams for leather; degreasers for cleaning boats; degreasers for marine bilge pumps; fabric stain removers; leather polishes; polishes for vinyl seats; polishing creams for vinyl seats; polishing wax for leather; polishing wax for vinyl; soap for boat use;

#### Class 05

(3) chemical preparations to treat mildew; deodorizers for boats; deodorizers for fish boxes;

### Claims

Priority Filing Date: July 09, 2019, Country or Office: UNITED STATES OF AMERICA, Application No: 88506171 in association with the same kind of goods (1); July 09, 2019, Country or Office: UNITED STATES OF AMERICA, Application No: 88506171 in association with the same kind of goods (3); July 09, 2019, Country or Office: UNITED STATES OF AMERICA, Application No: 88506171 in association with the same kind of goods (2)

**Application Number** 2,005,617  
**Language of Application** English

**Filing Date** 2020-01-10

## APPLICANT AND AGENT DETAILS

### Applicant

Snap Pea Design Inc.  
Suite 350, 137 Glasgow Street  
Kitchener  
ONTARIO  
N2G4X8

### Agent

PARLEE MCLAWS LLP  
1700 Enbridge Centre, 10175-101 Street NW,  
EDMONTON, ALBERTA, T5J0H3

## TRADEMARK DETAILS

# FURNA

### Trademark Type

Standard Characters

### Goods

#### Class 10

(1) Vaporizers for medical purposes

#### Class 34

(2) Oral vaporizers for smoking purposes

**Application Number** 2,007,996  
**Language of Application** English

**Filing Date** 2020-01-24

## APPLICANT AND AGENT DETAILS

### Applicant

SEQUEL NATURALS ULC  
101 - 3001 Wayburne Drive  
Burnaby  
BRITISH COLUMBIA  
V5G4W3

### Agent

BAKER & MCKENZIE LLP  
BROOKFIELD PLACE, 181 BAY STREET,  
SUITE 2100, P.O. BOX 874, TORONTO,  
ONTARIO, M5J2T3

## TRADEMARK DETAILS

# SPRING IN YOUR STEP

### Trademark Type

Standard Characters

### Goods

#### Class 05

(1) Nutritional supplement in tablet form for use in making an effervescent beverage when added to water, namely, effervescent vitamin tablets; nutritional and dietary supplements formed and packaged as bars, namely, nutritional supplement meal replacement bars containing vitamins and minerals; powdered nutritional supplement drink mix, namely, powdered protein supplement drink mixes for preparing sports drinks, energy drinks and isotonic drinks; nutritional supplements for general health and well-being; nutritional supplement meal replacement bars for boosting energy; nutritional supplement energy bars, namely, food supplements for general health and well-being, meal replacement bars for general health and well-being, building body mass and for enhancing physical and mental performance in snack bar form

#### Class 29

(2) Vegetable based snack foods; pea-based snack foods; nut-based snack foods; seed-based snack foods; vegetable based food bars; fruit based snack foods; non-dairy yogurt; plant-based yogurt substitutes, namely, soy based and nut based yogurts; dried fruit snack; Fruit-based meal replacement bars for boosting energy; Processed fruit- and nut-based food bars

#### Class 30

(3) Grain based food bars; grain-based snack foods; rice based food bars; cereal based energy bars; high-protein cereal bars; energy bars derived from nuts and seeds.

#### Class 32

(4) Concentrates or powders used in the preparation of sports and energy drinks; Energy drinks; smoothies; smoothie mixes; sport drinks; flavored enhanced water; water beverages, namely, effervescent water; powders for making soft drinks

**Application Number** 2,008,774  
**International Registration Number** 0959513  
**Language of Application** English

**Filing Date** 2019-10-25

## APPLICANT AND AGENT DETAILS

### Applicant

Oy Mapvision Ltd  
Ruosilantie 10  
FI-00390 Helsinki  
FINLAND

### Agent

ANDREWS ROBICHAUD  
1673 Carling Avenue, Suite 215, Ottawa,  
ONTARIO, K2A1C4

## TRADEMARK DETAILS

# MAPVISION

### Trademark Type

Standard Characters

### Goods

#### Class 09

Measuring equipment and apparatus, namely, optical gauges, optical jigs and optical scanners, all for three-dimensional measurement of physical objects, complex components and assemblies for use in the production of automotive, aerospace, motorbike, ATV, snowmobile, consumer products, and electronics components; measuring systems, namely, optical measuring systems comprised of optical gauges, optical jigs and optical scanners, all for three-dimensional measurement of complex components and assemblies for use in the production of automotive, aerospace, motorbike, ATV, snowmobile, consumer products, physical objects and electronics components; software programs for operation of optical measuring systems comprised of optical gauges, optical jigs and optical scanners, making optical measurements, and for the inspection, formatting and display of the measurement results; production automation software for connecting optical measuring systems comprised of optical gauges, optical jigs and optical scanners to production line control systems; production automation software for producing complex components and assemblies for use in the production of automotive, aerospace, motorbike, ATV, snowmobile, consumer products and electronics components; machine vision systems, namely, optical gauges for three-dimensional inspection of complex components and assemblies for use in the production of automotive, aerospace, motorbike, ATV, snowmobile, consumer products and electronics components

### Services

#### Class 37

(1) Installation, repair and maintenance of measuring and testing machines, instruments, systems and apparatus, namely, optical gauges, optical jigs, optical scanners, and optical measuring systems comprised of same

#### Class 42

(2) Scientific and technological services and research and design relating thereto in the field of optical measurements and inspections; industrial analysis and research services in the field of optical measurements and inspections; design and development of computer hardware and software

**Application Number** 2,011,758  
**International Registration Number** 1513657  
**Language of Application** English

**Filing Date** 2019-12-02

## APPLICANT AND AGENT DETAILS

**Applicant**  
BIOCONTROL TECHNOLOGIES, S.L.  
Av. Madrid 215, Ent. A  
E-08014 Barcelona  
SPAIN

**Agent**  
JANET DELL'ORTO  
(Lavery, de Billy, s.e.n.c.r.l.), Bureau 4000, 1  
Place Ville-Marie, Montréal, QUEBEC, H3B4M4

## TRADEMARK DETAILS

**Trademark Type**  
Design

**Visual Representation**



### Colour Claim

Colour is claimed as a feature of the trademark. The colors black, green, and white are claimed as a feature of the mark. The mark consists of the wording "T34" with the "T" in green and "34" in white. The word "BIOCONTROL" is below with "BIO" in green and "CONTROL" in white. The mark is situated on a black square background.



**Goods****Class 01**

(1) Microorganisms cultures other than for medical or veterinary use namely cell culture media for use in the biotechnological industry, artificial soil for plant cultivation; microorganism preparations other than for medical or veterinary use namely preparations for protecting plants against pathogens, chemical preparations for preventing pathogenic infections in plants, nutrient preparations for plants; fertilizer products, organic manures, manures for soil, agricultural land, substrates for agriculture; chemical products for agriculture, horticulture and forestry namely fertilizing preparations, namely substances for fortifying and regulating plant growth.

**Class 05**

(2) Cultures of microorganisms as ingredients for medical and veterinary preparations in the fields of research and treating diseases; cultures of microorganisms for medical or veterinary use namely cultures of microorganisms for use in dietary supplements, food supplements, vitamin and mineral preparations in the fields of research and treating diseases; preparations of microorganisms for medical and veterinary use namely antiparasitic preparations, insecticidal preparations; nutritive substances for microorganisms consisting of vitamins and minerals; nutritional supplements consisting of vitamins and minerals; fungicides for plant diseases control, fungicides for horticultural purposes, germicides and fungicides, biocides for plant diseases control; additives for medical use in feed namely fodder additives for medical purposes, animal feed additives.

**Application Number** 2,014,050  
**International Registration Number** 1517173  
**Language of Application** English

**Filing Date** 2019-09-19

## APPLICANT AND AGENT DETAILS

### Applicant

SAPRO TEMIZLIK ÜRÜNLERİ SANAYİ VE  
TİCARET ANONİM ŞİRKETİ  
Ortaköy Mahallesi, İtler Bulvarı, No:27  
TR-34582 Silivri - İstanbul  
TURKEY

### Agent

NEOMARK LTD.  
7450 rue Saint-Hubert, Montréal, QUEBEC,  
H2R2N3

## TRADEMARK DETAILS

### Trademark Type

Design

### Visual Representation



### Colour Claim

Colour is claimed as a feature of the trademark. The word SAPRO is in black. The wavy band before the word SAPRO is in light blue.

### Goods

#### Class 03

(1) Bleaching preparations for cosmetic purposes; bleaching preparations for the hair; bleaching salts; bleaching soda; leather bleaching preparations; all-purpose cleaning preparations; all-purpose cleaning preparations for smokers' articles; bathroom cleaning preparations; carpet cleaning preparations; cleaning fluids for camera lenses; cleaning fluids for spectacles; cleaning pads impregnated with cosmetics; cleaning preparations for automobile tires and wheels; cleaning preparations for cleansing drains; cleaning preparations for dishes; cleaning preparations for leather; cleaning preparations for plant leaves; cleaning preparations for use in toilets; cleaning solution for oral vaporizers for smoking; cleaning solutions for dental ultrasonic sterilization apparatus; denture cleaning preparations; drain cleaning preparations; dry-cleaning preparations; floor cleaning preparations; glass cleaning preparations; hair cleaning preparations; hand cleaning preparations; non-medicated cleaning preparations for use on the body; tooth cleaning preparations; wallpaper cleaning preparations; windscreen cleaning preparations; windshield cleaning preparations; laundry bleach; fabric softeners for laundry use; fabric stain removers; laundry stain removers; dishwasher detergents; perfumery; cosmetics (except medicated cosmetics); fragrances; deodorants for personal use; deodorants for pets; almond soaps; body soaps; buriti-based soaps; copaiba-based soaps; cosmetic soaps; cream soaps; facial soaps;

granulated soaps; hemp-based deodorant soaps; liquid bath soaps; liquid hand soaps; liquid soaps for hands, face and body; liquid soaps used in foot baths; loofah soaps; non-medicated body soaps; non-medicated liquid soaps; non-medicated soaps for personal use; non-medicated toilet soaps; perfumed toilet soaps; scented soaps; shaving soaps; shower soaps; skin soaps; soaps for body care; soaps for household use; soaps for laundry use; soaps for personal use; soaps for saddlery; soaps for toilet purposes; stainless steel soaps; toilet soaps; anti-cavity dental rinses; dental bleaching gels; dental rinses; non-medicated toothpaste; swallowable toothpaste; toothpaste; tooth whitening gels; dentifrices; denture polishes; tooth whitening preparations; mouthwashes, not for medical purposes; tissues impregnated with cosmetic lotions; tissues impregnated with make-up removing preparations.

### **Class 05**

(2) Radioactive pharmaceutical preparations for in vivo diagnostics or therapeutic use; acai powder dietary supplements; activated charcoal dietary supplements; albumin dietary supplements; alginate dietary supplements; amino acid dietary supplements; anti-oxidants for use as dietary supplements; bee pollen used as a dietary supplement; brewer's yeast dietary supplements; casein dietary supplements; chlorella dietary supplements; colostrum dietary supplements; copaiba powder dietary supplement; dietary food supplements in the nature of ready-to-eat protein bars; dietary supplement drink mixes for general health and wellbeing; dietary supplements consisting of amino acids, minerals and trace elements; dietary supplements consisting of vitamins; dietary supplements consisting primarily of calcium; dietary supplements consisting primarily of iron; dietary supplements consisting primarily of magnesium; dietary supplements for body weight control; dietary supplements for controlling cholesterol; dietary supplements for general health and well-being; dietary supplements for promoting weight loss; flaxseed dietary supplements; flaxseed oil dietary supplements; folic acid dietary supplements; glucose dietary supplements for animals; guaraná powder dietary supplement; hemp-based dietary supplements; lecithin dietary supplements; linseed dietary supplements; linseed dietary supplements for animals; linseed oil dietary supplements; medicated beverages in the nature of dietary supplements for colon detoxification; medicated beverages in the nature of dietary supplements for liver detoxification; mineral dietary supplements for animals; mineral dietary supplements for humans; mugwort dietary supplements; natural dietary supplements for treating claustrophobia; nutraceutical dietary supplement for maintaining general health and wellbeing; pine pollen dietary supplements; pollen dietary supplements; probiotic dietary supplements; propolis dietary supplements; protein powder dietary supplements; protein powders for meal replacement for use as a dietary supplement; red wine powder dietary supplements; royal jelly dietary supplements; soy isoflavone dietary supplements; soy protein dietary supplements; spirulina dietary supplements; vitamin and mineral dietary supplements; wheat dietary supplements; wheat germ dietary supplements; wheatgrass dietary supplements; whey protein concentrates being dietary supplements; whey protein hydrolysates being dietary supplements; whey protein isolates being dietary supplements; whey proteins being dietary supplements; yeast dietary supplements; yeast dietary supplements for animals; zinc dietary supplements; mineral nutritional supplements; non-medicated nutritional supplements for animal feed; nutritional supplements consisting of vitamins and minerals; nutritional supplements for building body mass; nutritional supplements for foodstuffs for animals; nutritional supplements for general health and well-being; nutritional supplements for livestock feed; slimming capsules; slimming pills; slimming tea for medical purposes; transdermal patches for use in the treatment of weight loss; weight loss lozenges; food for babies; herbs and herbal based dietetic beverages for babies adapted for medical purposes; herbs and herbal based electrolyte replacement beverages for medical purposes; herbs and herbal based beverages adapted for medicinal purposes for general health and well-being; dental

preparations for disclosing plaque; dental wax for the preparation of dental moulds; preparations to facilitate teething; dental materials for stopping the teeth; dental varnishes for sealing teeth; material for repairing teeth and for dental crowns and bridges; materials for artificial teeth; material for tooth crowns and tooth bridges for dental and dental technical purposes; materials for tooth restoration; teeth filling material; dental impression material; dental adhesives and material for repairing teeth; breast pads; feminine hygiene pads; incontinence pads; nursing pads; paper pads for changing diapers; reusable breast-nursing pads; hygienic tampons; adhesive plasters; anti-inflammatory analgesic plasters; corn plasters; dental plasters; gummed taffeta plasters; medical plasters; mustard plasters; plasters for medical purposes; sticking plasters; surgical plasters; bandages for dressings; dressings for burns; dressings for medical and veterinary purposes; dressings for wounds; first aid dressings; materials for dressing wounds; medical dressings; self-adhesive dressings; sterile burn dressings; sterile dressings; surgical dressings; transparent film dressings; wound dressings; diapers, including those made of paper and textiles; babies' diapers of paper; babies' diapers of textile; babies' napkins of paper; adult diapers of paper; adult diapers of textile; diapers for pets; preparations for destroying vermin; fungicides, herbicides; rodenticides; air deodorants; bathroom deodorants; car deodorants; deodorants for clothing; deodorants for refrigerators; deodorants for textiles; deodorants for upholstery; room deodorants; toilet deodorants; air deodorising preparations; all-purpose disinfectants; contact lens disinfectants; disinfectants for chemical toilets; disinfectants for dental and medical apparatus and instruments; disinfectants for household purposes; disinfectants for swimming pools; kennel disinfectants; sulphur sticks as disinfectants; urinary tract disinfectants; antiseptics; detergents for medical purposes; medicated soap for the treatment of rosacea; medicated soaps for babies; disinfectant soap; antibacterial hand lotions.

### **Class 16**

(3) Paper and cardboard; paper and cardboard for packaging and wrapping purposes, cardboard boxes; paper towels; toilet paper; paper napkins; plastic materials for packaging and wrapping purposes; printing blocks and types; bookbinding material; art prints; printed advertising boards of cardboard; printed advertising boards of paper; printed awards; printed calendars; printed flip charts; printed invitations; printed material in the nature of color samples; printed menus; printed patterns for dressmaking; printed sheet music; printed tags; printed timetables; books; magazines; newspapers; bill books; printed dispatch notes; printed vouchers; calendars; posters; photographs [printed]; paintings; stickers [stationery]; postage stamps; paper stationery; stationery agendas; stationery binders; stationery cases; stationery labels; stationery pencil ornaments; stationery personal organizers; stationery seals; stationery stickers; stationery tabs; writing stationery; office stationery; writing and drawing implements; artists' brushes; artists' moulds; artists' palettes; artists' pastels; artists' pencils; artists' pens; artists' watercolour saucers; canvas stretcher bars for artists; paper products for stationery purposes; adhesives for stationery purposes; pens; pencils; erasers; adhesive tapes for stationery purposes; cardboard cartons [artists' materials]; writing paper; copying paper; paper rolls for cash registers; drawing materials; chalkboards; painting pencils; watercolors [paintings]; office binders; office glues; office hole punchers; office machine ribbons; office paper stationery; office perforators; office requisites in the form of finger-stalls; office rubber stamps; office supply binders; bookbinding machines for office use; clips for offices; elastic bands for offices; electric staplers for offices; envelope sealing machines for offices; staples for offices; paint rollers and paintbrushes for painting.

### **Claims**

Priority Filing Date: September 09, 2019, Country or Office: TURKEY, Application No: 2019/84574 in association with the same kind of goods

**Application Number** 2,014,806  
**Language of Application** English

**Filing Date** 2020-02-28

## APPLICANT AND AGENT DETAILS

### Applicant

D&L CAFE HOLDINGS INC.  
706 Bloor Street West  
Suite 200  
Toronto  
ONTARIO  
M6G1L4

### Agent

BERESKIN & PARR LLP/S.E.N.C.R.L., S.R.L.  
SCOTIA PLAZA, 40 KING STREET WEST,  
40th FLOOR, TORONTO, ONTARIO, M5H3Y2

## TRADEMARK DETAILS

# POOP CAFE

### Trademark Type

Standard Characters

### Goods

#### Class 30

frozen confectionery, frozen desserts, ice cream; waffles

### Services

#### Class 43

restaurant, café and dessert bar services

**Application Number** 2,018,092  
**Language of Application** English

**Filing Date** 2020-03-18

## **APPLICANT AND AGENT DETAILS**

### **Applicant**

Candice Cantave  
992 73 St SW  
Calgary  
ALBERTA  
T3H5W5

### **Agent**

WILLIAM R. STEMP  
(STEMP & COMPANY), 1670, 734 - 7 Avenue  
SW, Calgary, ALBERTA, T2P3P8

## **TRADEMARK DETAILS**

**Trademark Type**  
Design

**Visual Representation**

**P L U S**

### **Goods**

#### **Class 24**

(1) bath towels; bed sheet sets; duvets; pillow cases;

#### **Class 27**

(2) bath mats;

**Application Number** 2,018,093  
**Language of Application** English

**Filing Date** 2020-03-18

## APPLICANT AND AGENT DETAILS

### Applicant

Candice Cantave  
992 73 St SW  
Calgary  
ALBERTA  
T3H5W5

### Agent

WILLIAM R. STEMP  
(STEMP & COMPANY), 1670, 734 - 7 Avenue  
SW, Calgary, ALBERTA, T2P3P8

## TRADEMARK DETAILS

# PLUSS

### Trademark Type

Standard Characters

### Goods

#### Class 24

(1) bath towels; bed sheet sets; duvets; pillow cases;

#### Class 27

(2) bath mats;

**Application Number** 2,019,203  
**Language of Application** English

**Filing Date** 2020-03-25

## **APPLICANT AND AGENT DETAILS**

### **Applicant**

Clarity Clinical Skin Care Inc.  
3145 Old Conejo Road  
Newbury Park, CA 91320  
UNITED STATES OF AMERICA

### **Agent**

GOWLING WLG (CANADA) LLP  
SUITE 1600, 1 FIRST CANADIAN PLACE, 100  
KING STREET WEST, TORONTO, ONTARIO,  
M5X1G5

## **TRADEMARK DETAILS**

# **GLIMMER OF HOPE**

### **Trademark Type**

Standard Characters

### **Goods**

#### **Class 03**

Anti-aging skin care preparations; body and beauty care cosmetics; cosmetic oils for the face, hands and body; essential oils for personal use; massage oils and lotions; non-medicated skin care preparations; skin care preparations; non medicated facial and neck oils for moisturizing, calming, and soothing; cosmetic facial and neck oils



**Application Number** 2,019,349  
**International Registration Number** 1368686  
**Language of Application** English

**Filing Date** 2019-10-25

## APPLICANT DETAILS

### Applicant

JJ GLOBAL TURIZM ORGANIZASYON  
SANAYI VE TICARET ANONIM SIRKETI  
Levazim Mah. Karaca Sk. Birkent  
Sitesi L Blok Apt. No:4 O/2  
Besiktas Istanbul  
TURKEY

## TRADEMARK DETAILS

### Trademark Type

Design

### Visual Representation

**JOJO MAY**

### Goods

#### Class 03

All-purpose cleaning preparations; bleaching preparations for cosmetic use; detergents other than for use in manufacturing operations and for medical purposes, namely, detergents for laundry, laundry bleach, fabric softeners for laundry use, pet, laundry and fabric stain removers, dishwasher detergents, perfumery; cosmetics; fragrances; deodorants for personal use and animals, non-medicated soaps, namely body soaps and deodorant soaps, dental rinses for non-medical purposes; dentifrices, denture polishes, tooth whitening preparations, mouth washes, not for medical purposes, abrasive preparations for nail polishing and floor polishing; abrasive preparations made of aluminium oxide; abrasive preparations for all purpose scouring; emery cloth; sandpaper; pumice stone; abrasive pastes for polishing and scouring, polishing preparations for leather, vinyl, metal and wood, polishes and creams for leather, vinyl, metal and wood, wax for polishing.

### Services

#### Class 35

(1) Advertising, marketing and public relations services for others; organisation of exhibitions and trade fairs for commercial or advertising purposes for others in the field of cosmetics, health and beauty; providing office functions, namely, mail processing, dictation transcription, typing, printing, copying, filing, record management and drafting of office communications; secretarial services; arranging newspaper subscriptions for others; compilation of statistics; rental of office machines; systemization of information into computer databases; telephone answering for unavailable subscribers; retail store services, wholesale outlet store services, online retail and wholesale store

services, and mail order catalogue services, all featuring bleaching and cleaning preparations, detergents other than for use in manufacturing operations and for medical purposes, laundry bleach, fabric softeners for laundry use, pet, laundry and fabric stain removers, dishwasher detergents, perfumery, cosmetics, fragrances, deodorants for personal use and animals, soaps, dental care preparations, dentifrices, denture polishes, tooth whitening preparations, mouth washes, not for medical purposes, abrasive preparations for household use and abrasive preparations, namely abrasive pastes, abrasive soaps and abrasive powders, emery cloth, sandpaper, pumice stone, abrasive pastes, polishing preparations for leather, vinyl, metal and wood, polishes and creams for leather, vinyl, metal and wood, wax for polishing; auctioneering, business management, business administration and business management consultancy; accounting; commercial business management consultancy services; personnel recruitment, personnel placement, employment agencies, import-export agencies; temporary personnel placement services.

#### **Class 44**

(2) Medical services, namely, cosmetic facial, body and hair treatments and procedures and cosmetic surgery treatments and procedures; pest control services for agriculture, horticulture and forestry services, landscape gardening, veterinary services, animal husbandry, animal breeding of cats, dogs, horses, cows, sheep, fowl and rabbits; shoeing horses [farrier services], beauty care services, namely, facial and body treatments, esthetician, hair stylist, cosmetologist and nail care services; medical advisory services in the field of personal health, namely, diet and weight loss consulting services and consulting on cosmetic treatments and procedures.

**Application Number** 2,019,583  
**International Registration Number** 1292628  
**Language of Application** English

**Filing Date** 2020-02-10

## APPLICANT AND AGENT DETAILS

### Applicant

2Xideas AG  
Seestrasse 39  
CH-8700 Küsnacht  
SWITZERLAND

### Agent

PERLEY-ROBERTSON, HILL & MCDUGALL  
LLP  
1400 - 340 ALBERT STREET, OTTAWA,  
ONTARIO, K1R0A5

## TRADEMARK DETAILS

# 2Xideas

### Trademark Type

Standard Characters

### Services

#### Class 36

Financial and monetary affairs and financial services, namely, financial investment advisory, financial forecasting, financial management and planning services, financial analyses services, wealth and asset investment brokerage (in particular fortune and asset investment in funds and other financial instruments, shares, raw materials and derivatives), development, creation and presentation of proposals for wealth and asset investments, development and brokerage of strategies for wealth and asset investment, consultancy services with respect to wealth and asset investment and with respect to wealth and asset investment, creation of wealth and asset investment projects, financial consultancy with respect to brokerage for investments of wealth, assets and financial affairs, in particular in the fields of funds, capital investments, financial analysis, stock markets, in particular trading of financial securities (in particular fund securities), foreign exchange, financial evaluation and valuation of property (in particular of financial investments, companies and wealth), financial brokerage for investments of wealth, assets and financial affairs, in particular in the fields of funds, capital investments, financial analysis, stock markets, in particular trading of financial securities (in particular fund securities), options, derivatives, foreign exchange, financial evaluation and valuation of property (in particular of financial investments, companies and wealth), online information services relating to the aforesaid services, in particular information services in the fields of financial investment advisory, financial forecasting, financial management and planning services, financial analyses services, wealth and asset management, wealth and asset investment, and consulting services for all the aforesaid services, in particular consulting services for wealth and estate investment, for financial planning, for financial analyzes and for financial management; wealth management, wealth and asset management and property management, in particular of funds and fund securities, security deposits, providing news and electronic messages in the fields of finance and monetary affairs, preparation of financial reports; provision of financial information by computer networks (particularly the Internet), consulting services for all the aforesaid services, in particular consulting services for wealth and estate investment, for financial planning, for financial analyzes and for financial management.

**Application Number** 2,020,659  
**International Registration Number** 1522768  
**Language of Application** English

**Filing Date** 2020-02-06

## APPLICANT AND AGENT DETAILS

### Applicant

TravelPerk, S.L.U.  
Avenida Diagonal, 211  
E-08018 Barcelona  
SPAIN

### Agent

MAY M.M. CHENG  
(Dipchand LLP), 401 Bay Street, Suite 2100,  
Toronto, ONTARIO, M5H2Y4

## TRADEMARK DETAILS

### Trademark Type

Design

### Visual Representation



### Colour Claim

Colour is claimed as a feature of the trademark. The trademark design and words TRAVELPERK are blue

### Goods

#### Class 09

Computer software for booking business and leisure travel tours, seats for travel, and hotel, motel, tourist inns and vacation resort reservations; Computer hardware; downloadable computer applications for booking business and leisure travel tours, seats for travel and hotel, motel, tourist inns and vacation resort reservations; downloadable electronic publications in the nature of books, magazines, periodicals and newsletters in the field of business and leisure travel; Computer software for management of business and leisure travel support services pre-sale and post-sales, namely, software for monitoring and processing of information relating to customer complaints, booking changes and cancellations, and processing of fare changes and refunds; customer service management software

### Services

#### Class 39

(1) Arranging of business and leisure travel tours; travel agency services for business travel; Arranging and booking seats for business and leisure travel and hotel, motel, tourist inns and vacation resort reservations via the Internet; information and consultancy services relating to travel; providing information by electronic media relating to the planning and booking of travel and

transport; travel reservation; after-sales services in connection with travel organization; consultancy services relating to travel provided by telephone call centers and telephone hotlines

**Class 42**

(2) Software design and development.

**Class 43**

(3) Accommodation reservation services, namely, booking of hotel, motel, tourist inns and vacation resort reservations via the Internet for business and leisure travellers; provision of information regarding accommodation for travelers and services provided by accommodation reservation agencies for travellers; after-sales services in connection with business and leisure travel accommodation reservations, namely, providing information on tourist attractions, travel tour guides, sightseeing excursions, dining recommendations, providing information and recommendations on places for business events and conventions

**Claims**

Priority Filing Date: October 09, 2019, Country or Office: EUIPO (EU), Application No: 018134215 in association with the same kind of goods and in association with the same kind of services

**Application Number** 2,020,790  
**International Registration Number** 1427886  
**Language of Application** English

**Filing Date** 2020-03-04

## APPLICANT AND AGENT DETAILS

### Applicant

MASSACHUSETTS INSTITUTE OF  
TECHNOLOGY  
77 Massachusetts Avenue  
Cambridge MA 02139  
UNITED STATES OF AMERICA

### Agent

SMART & BIGGAR LP  
1100-150 York street, TORONTO, ONTARIO,  
M5H3S5

## TRADEMARK DETAILS

# SOLVER

### Trademark Type

Standard Characters

### Services

#### Class 35

Arranging and conducting competitions for participants to compete for seed capital, financial support, business support, technology support, and related funding and business mentoring, to implement business plans and facilitate business activities; arranging and conducting competitions for participants to compete for seed capital, financial support, business support, technology support, and related funding and business mentoring, to facilitate the execution of business plans designed to address community and global challenges in the fields of environmental, humanitarian, educational, economic, health, and social issues; arranging and conduction exhibitions, meetings, gatherings, and events that promote the exchange of information and resources within the scientific, research, education, and business communities to address community and global challenges in the fields of environmental, humanitarian, educational, economic, health, and social issues, and to implement business solutions to achieve advancements at the community and global levels; arranging and conducting exhibitions, meetings, gatherings, and events that promote collaboration within the education, scientific, research, and business communities to achieve societal advancements in the fields of environmental, humanitarian, educational, economic, health, and social issues; arranging and conducting exhibitions, meetings, gatherings, and events that promote public awareness of community and global challenges by providing forums for individuals and entrepreneurs to present ideas, innovations, and business plans designed to address specific challenges at the global or community levels; arranging and conducting exhibitions, meetings, gatherings, and events that promote public awareness of community and global challenges by providing live forums for participants to present ideas, innovations, and business plans designed to address specific challenges at the global or community levels, for review and discussion among a live audience and panel of leaders, innovators, and experts in a wide variety of fields; advertising services, namely, promoting public awareness of initiatives, programs, developments, ideas, innovations, and discoveries that address community and global challenges, via community outreach campaigns and events, and global outreach campaigns and events; organization of conferences, demonstrations, meetings, symposia, and events for business purposes; advertising

services, namely, promoting public awareness of community and global challenges; advertising services, namely, promoting public awareness of the need for business, community, educational, and institutional collaboration to address community and global challenges.

**Application Number** 2,021,830  
**International Registration Number** 1524354  
**Language of Application** English

**Filing Date** 2020-03-02

## APPLICANT AND AGENT DETAILS

**Applicant**  
INNOPRICK, S.L.  
Paseo Mikeletegi, 83  
E-20009 San Sebastián (Gipuzkoa)  
SPAIN

**Agent**  
ROBIC  
630, boul. René-Lévesque Ouest, 20e étage,  
Montréal, QUEBEC, H3B1S6

## TRADEMARK DETAILS

**Trademark Type**  
Design

**Visual Representation**

The image shows the word "nexkin" in a bold, blue, lowercase sans-serif font. The letters are thick and rounded, with a consistent blue color throughout. The word is centered horizontally and occupies most of the width of the page.

### Colour Claim

Colour is claimed as a feature of the trademark. The colours blue and white are claimed as a feature of the mark. The word NEXKIN is blue on a white background.

### Goods

#### Class 10

Medical diagnostic apparatus for medical use, namely, digital medical apparatus for identifying and diagnosing allergies; medical diagnostic apparatus for testing for detecting allergies; diagnostic apparatus for allergies, namely, digital medical apparatus for identifying and diagnosing allergies, diagnostic kits comprising diagnostic agents, preparations and substances for testing and identifying allergies; measuring apparatus for medical use, namely, medical apparatus for measuring papules in skin allergy tests.

### Services

#### Class 42

Design and development of medical technology comprising digital medical apparatus for identifying and diagnosing allergies; design and development of digital medical diagnostic apparatus for identifying and diagnosing allergies; design and development of measuring apparatus, namely, medical apparatus for measuring papules in skin allergy tests; design of measuring systems for



measuring papules in skin allergy tests; development of measuring papules in skin allergy tests and allergy testing methods.

**Claims**

Priority Filing Date: October 31, 2019, Country or Office: EUIPO (EU), Application No: 18145297 in association with the same kind of goods and in association with the same kind of services

**Application Number** 2,022,682  
**International Registration Number** 1525537  
**Language of Application** English

**Filing Date** 2019-10-31

## APPLICANT AND AGENT DETAILS

### Applicant

Spandex Limited  
1600 Park Avenue, Aztec West  
Almondsbury, Bristol BS32 4UA  
UNITED KINGDOM

### Agent

BORDEN LADNER GERVAIS LLP  
Bay Adelaide Centre, East Tower, 22 Adelaide  
St. West, TORONTO, ONTARIO, M5H4E3

## TRADEMARK DETAILS

### Trademark Type

Design

### Visual Representation



### Colour Claim

Colour is claimed as a feature of the trademark. The word "spandex" is shown in red, and the design element to the left of the word "spandex" is shown in grey.

### Services

#### Class 35

(1) Wholesale store services, retail services, online wholesale services, online retail services, wholesale services via a distributorship, retail services via a distributorship, online wholesale services by a distributorship and online retail services via a distributorship, all the aforementioned services featuring vinyl films and vinyl foils and self-adhesive vinyl films and vinyl foils for use in sign making and vehicle-wrapping, coloured vinyl films, printable self-adhesive vinyl films, self-adhesive films for application to vehicles, films for architectural and interior decor purposes, namely, decorative films and protective films for application to internal and external walls, floors, and windows, and blackboard and whiteboard films, decorative films and protective films for application to furniture (including built in furniture) and furnishings, films for application to glass, namely, glass safety and protection films, sun control films, and privacy films, and self-adhesive tapes for use in sign making; wholesale store services, retail services, online wholesale services,

online retail services, wholesale services via a distributorship, retail services via a distributorship, online wholesale services by a distributorship and online retail services via a distributorship services, all the aforementioned services featuring application tapes and adhesive tapes for signmaking, cleaning materials, namely cleaning cloths and pads, surface cleaners, and spray bottles, adhesive film removing products, adhesive removing products, vinyl removing products, heat guns, cutting tools namely knives, scalpels, and blades, measuring tools namely laser measuring device to measure existing signs for replacement or maintenance or to measure areas for new sign placement, sealants, eyelet presses, welding machines for plastics materials, squeegees, rollers, gloves, ink, ink cartridges, paper, laminating materials namely overlamine films and liquid overlaminates, plotters, printers, routers, namely machine tools, banner system units and sign system units; wholesale store services, retail services, online wholesale services, online retail services, wholesale services via a distributorship, retail services via a distributorship, online wholesale services by a distributorship and online retail services via a distributorship, all the aforementioned services featuring composite materials comprising predominantly plastics material and also metal, non-metallic building and construction materials, predominantly non-metallic building and construction materials, non-metallic building materials, predominantly non-metallic building materials for making signs and information and advertising displays; wholesale store services, retail services, online wholesale services, online retail services, wholesale services via a distributorship, retail services via a distributorship, online wholesale services by a distributorship and online retail services via a distributorship, all the aforementioned services featuring nameplates, number plates, placards of wood, placards of plastics, signboards of wood, signboards of plastics, decorative and art materials and media materials, namely canvas materials and inkjet papers and inkjet films for wall decoration and interior decor, fabrics, curtains, wall hangings, tablecloths, fabrics for manufacturing tents, textile materials (including those that are self-adhesive) for use in the manufacture of blinds, floor coverings and wallpaper, textile materials (including those that are self-adhesive) for use in sign making, graphics, advertising media, interior decor applications, curtains, upholstery and soft furnishings; providing information and advice to consumers regarding the selection and purchasing of materials used in sign making; advertising and business management consultancy services, advertising the goods and services of others, production of advertising materials for others; retail and wholesale services via a distributorship featuring the sale of sign making apparatus, and supplies for use with sign making apparatus.

#### **Class 42**

(2) Technical support advisory services in the field of sign making, sign design, and the graphic arts industries, namely, troubleshooting in the nature of diagnosing problems with digital sign making and wide format printing equipment, and related technical support advisory and consulting services.

**Application Number** 2,023,394  
**Language of Application** English

**Filing Date** 2020-04-20

## APPLICANT AND AGENT DETAILS

### Applicant

AGC Manufactura I, S.A. de C.V.  
Vía José López Portillo Número 131  
Colonia La Magdalena  
Coacalco de Berriozábal, CP55700  
MEXICO

### Agent

SMART & BIGGAR LP  
SUITE 900, 55 METCALFE STREET, P.O.  
BOX 2999, STATION D, OTTAWA, ONTARIO,  
K1P5Y6

## TRADEMARK DETAILS

### Trademark Type

Design

### Visual Representation



**Colour Claim**

Colour is claimed as a feature of the trademark. The front surface of the stylized letter "F" is red with a graduated shadow in grey.

**Goods****Class 12**

Trailer parts and components, namely, structural repair and replacement parts for semi-tractor trailers

**Claims**

Priority Filing Date: April 06, 2020, Country or Office: UNITED STATES OF AMERICA, Application No: 88/861,414 in association with the same kind of goods

**Application Number** 2,023,846  
**International Registration Number** 1526558  
**Language of Application** English

**Filing Date** 2019-11-16

## APPLICANT AND AGENT DETAILS

### Applicant

UPLERS SOLUTIONS PRIVATE LIMITED  
2nd Floor, Bhagyashree, Nr. Kalasagar Mall,  
Satadhar Cross Roads  
Ahmedabad 380061 Gujarat  
INDIA

### Agent

MILTONS IP/P.I.  
#200-15 Fitzgerald Road, Ottawa, ONTARIO,  
K2H9G1

## TRADEMARK DETAILS

### Trademark Type

Design

### Visual Representation

# UPLERS

### Goods

#### Class 09

Downloadable computer software for running development programs and application programs in a common development environment; downloadable computer programs namely software and mobile applications for management and administration of daily tasks; data processing equipment, namely computers, computer hardware, keyboards, monitors, mouse, computer printers and scanners; computers; downloadable computer software platforms for assisting programming developers to collaborate on digital computer programming code as used in multiple application programs; downloadable electronic publications in the nature of technical guides, user guides, brochures, manuals, promotional materials, newsletters, in the fields of computer software, computer programming, and information technology; downloadable computer game programs; downloadable computer game software; audio equipment namely, audio speakers, headphones; audio visual equipment namely, digital projectors; downloadable and recorded multimedia publications in the nature of technical guides, user guides, brochures, manuals, promotional materials, newsletters, in the fields of computer software, computer programming, and information technology; photographic devices namely, video projectors, webcams

### Services

#### Class 35

(1) on-line advertising for others on computer networks; business management; business administration; direct marketing of the goods and services of others; social media marketing; Digital Marketing, services for goods and services of others, namely, developing digital marketing

strategies and digital marketing concepts, digital marketing data collection and analysis, creating and distributing targeted digital promotions telemarketing services for others; consultancy namely online consultancy relating to brand management, search engine optimization, accounting, book keeping, taxation, personnel recruitment and call centres for others; outsourcing services namely, providing business management assistance; outsourcing services namely, procurement of contracts for the purchase and sale of goods and services of others; business management and business management consultancy for freelance service providers; organizing trade fairs, events and exhibitions for commercial and advertising purposes in the field of business management, marketing and computer hardware and software technical support services; analysis of market research data and statistics

#### **Class 41**

(2) Education services, namely, providing of training in the fields of computer hardware and software technical support services, retail and online marketing, advertising, promotional services, and business strategies; organizing sporting and cultural activities, namely, conducting tournaments, contests and competitions in the field of computer hardware and software technical support services, entrepreneurship, marketing and business strategies; arranging and conducting of art exhibits; educational conferences and tutorial sessions in the fields of computer hardware and software technical support services, retail and online marketing, advertising, promotional services and business strategies, and award ceremonies in the nature of providing recognition and incentives by way of awards to demonstrate excellence in the fields of information technology, retail and online marketing, advertising, promotional services, and business strategies; publishing of electronic publications; publishing of books; online electronic publishing of books

#### **Class 42**

(3) Industrial analysis and research services in the field of web design and development; technical data analysis namely, computer system and computer network analysis; technical data analysis services in the field of computer software and computer software products; providing information relating to computer programs; design, development and maintenance of computer software, downloadable applications for handheld computers and mobile phones; design, development and maintenance of websites; design and development of computer hardware; graphic designing services; research, consultation and engineering services in the field of computer hardware and software technical support services; outsource service providers in the field of computer hardware and software technical support services; creating, designing, maintaining, implementing and hosting websites for others; consulting services in the field of providing online, non-downloadable software and applications; computer services namely, design and development of text, sound, and graphics for use on computer networks, wireless networks, and global communication networks; consulting services in the field of software as a service (SAAS); computer consulting services in the field of analysis, design, and implementation of computer hardware and software, operating systems, database systems, and web applications; technical support services, namely, troubleshooting of computer software problems; technical support services, namely, troubleshooting in the nature of diagnosing computer hardware and software problems; computer technical support services, namely, 24/7 service desk or help desk services for computer hardware and software, operating systems, database systems, and web applications

#### **Claims**

Priority Filing Date: September 09, 2019, Country or Office: INDIA, Application No: 4288205 in association with the same kind of goods; September 09, 2019, Country or Office: INDIA, Application No: 4288209 in association with the same kind of services (3); September 09, 2019, Country or Office: INDIA, Application No: 4288208 in association with the same kind of services

(2); September 09, 2019, Country or Office: INDIA, Application No: 4288206 in association with the same kind of services (1)



**Application Number** 2,024,554  
**Language of Application** English

**Filing Date** 2020-04-24

## APPLICANT AND AGENT DETAILS

### Applicant

Fastenal IP Company  
2001 Theurer Blvd  
Winona, MN 55987  
UNITED STATES OF AMERICA

### Agent

BORDEN LADNER GERVAIS LLP  
Bay Adelaide Centre, East Tower, 22 Adelaide  
St. West, TORONTO, ONTARIO, M5H4E3

## TRADEMARK DETAILS

# FASTENAL

### Trademark Type

Standard Characters

### Goods

#### Class 25

Shirts, sweatpants, jackets and hats

### Claims

Priority Filing Date: April 24, 2020, Country or Office: UNITED STATES OF AMERICA, Application No: 88/886,438 in association with the same kind of goods

**Application Number** 2,025,239  
**Language of Application** English

**Filing Date** 2020-04-29

## APPLICANT AND AGENT DETAILS

### Applicant

Allogene Therapeutics, Inc.  
210 E. Grand Avenue  
South San Francisco, CA 94080  
UNITED STATES OF AMERICA

### Agent

CLARK WILSON LLP  
900 - 885 WEST GEORGIA STREET,  
VANCOUVER, BRITISH COLUMBIA, V6C3H1

## TRADEMARK DETAILS

# ALLO IPSC

### Trademark Type

Standard Characters

### Goods

#### Class 05

Pharmaceutical preparations, namely, preparations for use in the treatment of cancer and tumors; pharmaceutical and biological preparations for immunotherapy, including T Cell therapy

### Claims

Priority Filing Date: November 02, 2019, Country or Office: UNITED STATES OF AMERICA,  
Application No: 88678000 in association with the same kind of goods

**Application Number** 2,025,245  
**Language of Application** English

**Filing Date** 2020-04-29

## APPLICANT AND AGENT DETAILS

### Applicant

Allogene Therapeutics, Inc.  
210 E. Grand Avenue  
South San Francisco, CA 94080  
UNITED STATES OF AMERICA

### Agent

CLARK WILSON LLP  
900 - 885 WEST GEORGIA STREET,  
VANCOUVER, BRITISH COLUMBIA, V6C3H1

## TRADEMARK DETAILS

# ALLO-IPSC

### Trademark Type

Standard Characters

### Goods

#### Class 05

Pharmaceutical preparations, namely, preparations for use in the treatment of cancer and tumors; pharmaceutical and biological preparations for immunotherapy, including T Cell therapy

### Claims

Priority Filing Date: November 02, 2019, Country or Office: UNITED STATES OF AMERICA,  
Application No: 88677998 in association with the same kind of goods

**Application Number** 2,025,281  
**International Registration Number** 1527464  
**Language of Application** English

**Filing Date** 2019-12-20

## APPLICANT AND AGENT DETAILS

### Applicant

Umang Patel; Shivom Enterprises Pty Limited  
8 Cavasinni Place  
Wetherill Park NSW 2164  
AUSTRALIA

### Agent

JOHN H. SIMPSON  
(SHIFT LAW PROFESSIONAL  
CORPORATION), 60 St. Clair Ave. East, Suite  
403, Toronto, ONTARIO, M4T1N5

## TRADEMARK DETAILS

### Trademark Type

Design

### Visual Representation



### Colour Claim

Colour is claimed as a feature of the trademark. The term CHATZPATS and the apostrophes over the letter H and the letter Z are LIME GREEN surrounded in BLACK; Each letter and apostrophe have DARK GREEN inside the black surround; The ribbon is a gradation of DARK RED from dark to lighter to dark and BROWN for the underlying portion on the right with the colour GOLD surrounding the ribbon and underneath the curve on the right side;

### Goods

#### Class 29

(1) Drinks flavoured with spices and having a base of milk; pickled peppers; pickled vegetables; pickles; Sweet pickled fruits and vegetables; cocoa butter; curry (prepared meals with or without rice, other than ricebased), namely, curry-based prepared meals consisting of rice, curry-based

prepared meals without rice consisting primarily of meat substitutes, curry-based prepared meals without rice consisting primarily of seafood, curry-based prepared meals without rice consisting primarily of tofu, curry-based prepared meals without rice consisting primarily of vegetables, curry-based prepared meals without rice consisting principally of poultry, pre-cooked curry stew; desserts made from milk products, namely, chilled dairy desserts, ice cream desserts; deep frozen vegetables; foods made from milk products, namely, cheese, yogourt, butter; milk products; edible oils; deep frozen foods in this class, namely, frozen fruits, frozen meat dinners, frozen fish dinners; prepared sesame seeds; prepared snacks made from dried fruit; frozen vegetables; mixed pickles; pickled cucumbers; pickled fruit; pickled gherkins; pickled onions; salted nuts; vegetarian vegetablebased frozen foods, namely, prepared meals consisting primarily of vegetables, frozen vegetables; edible seeds, namely, sunflower seeds, pumpkin seeds; seeds prepared for human consumption, namely, prepared sunflower seeds, prepared pumpkin seeds, poppy seeds, prepared; seeds, prepared, namely, baru seeds and chia seeds, prepared; prepared snacks made from dried vegetables; prepared snacks made from nuts

### **Class 30**

(2) Curry spices; Fruit tea not for medical purpose; herbal tea not for medicinal use); iced tea; mate tea; nonmedicated tea bags; orange flavoured tea not for medicinal use); tea; cocoa; cocoa products, namely, cocoa powder, cocoa spreads, cocoa-based beverages; rice; pizza spices; rice crackers; rice flour; wild rice, prepared; corn flour; flour; flour for food; flour mixes; flour of millet; flour-based food products, namely, flourbased dumplings, flour-based gnocchi, bread, buns, pastries; maize flour; spices; snack food products made from maize flour; corn-based snack food; snack food products made from rice flour; snack food products made from soya flour; snack foods prepared from potato flour; soya flour; wheat flour; salt for cooking; sea salt for cooking; mustard; coffee; confectionery, namely, almond confectionery, chocolate confectionery, confectionery fruit jellies, confectionery ices, frozen confectionery, fruit confectionery; dairy confectionery; spicy sauces, namely, hot sauce, chili sauce, pepper sauce, curry sauce; tomato based sauces; sugar; sugar coated peanuts; sugared almonds; pastry; puff pastry; prepared snacks for human consumption made from cereals; flavourings made from pickles; sweetmeats made of sesame oil; curry spice, namely, curry powder, curry paste; curry spice mixes; curry paste; curry powder; curry sauces; snack food products consisting of cereal products; snack food products made from cereal flour; snack food products made from cereals; sweet pickle condiment; snack food products made from potato flour; snack food products made from rice; snack foods consisting principally of bread; snack foods consisting principally of confectionery; snack foods consisting principally of extruded cereals; snack foods consisting principally of grain; snack foods consisting principally of pasta; sago; snack foods consisting principally of rice; snack foods made from cereals; snack foods made from corn; snack foods made of wheat; snack foods made of whole wheat; snack foods prepared from cereals; snack foods prepared from grains; snack foods prepared from maize; apple flavoured tea; chai tea; Relishes made of pickles; pickle relish

**Application Number** 2,026,534  
**International Registration Number** 1529376  
**Language of Application** English

**Filing Date** 2019-11-20

## APPLICANT AND AGENT DETAILS

### Applicant

SIHEALTH LTD  
Building R104, Rutherford Appleton Laboratory,  
Harwell Campus  
Didcot, Oxfordshire OX110QX  
UNITED KINGDOM

### Agent

GOWLING WLG (CANADA) LLP  
SUITE 2600, 160 ELGIN STREET, OTTAWA,  
ONTARIO, K1P1C3

## TRADEMARK DETAILS

### Trademark Type

Design

### Visual Representation



### Goods

#### Class 09

(1) Computer software relating to the medical field, namely downloadable computer software for use in the field of healthcare to diagnose and monitor health conditions of patients and to manage patient medical records; artificial intelligence software for healthcare, namely downloadable health monitoring software for analyzing, detecting, computing, and tracking patient vital statistics, symptoms, medications, skin conditions, diet, and exercise for diagnosing and monitoring patient diseases and health conditions and for use in medical decision support systems for patients; biometric software, namely downloadable facial recognition software, voice recognition software, and software for the management of medical biometric information received from patients for monitoring health conditions, skin phototype, skin diseases classification and patient symptom mapping; environmental control software, namely downloadable mobile application software for use with wearable computer devices for monitoring patient health conditions, vital statistics, sunlight exposure, skin conditions, oxygen levels, vitamin D status, hydration, caloric intake, drug dose administration, air humidity, air pollution, air temperature; health monitoring software, namely downloadable computer software for monitoring patient health conditions, vital statistics, sunlight exposure, skin conditions, oxygen levels, vitamin D status, hydration, caloric intake, drug dose administration, skin diseases classification and patient symptom mapping; personal computers incorporating dietary aid computer software, namely personal computers with software for monitoring nutrition intake; computer software for use in medical decision support systems, namely downloadable computer software that analyzes data within electronic health records of patients to provide prompts and reminders to assist health care providers in implementing medical treatments; virtual reality software for medical teaching; downloadable computer software for the management of data and information, namely computer software for database management; downloadable

computer software applications, namely application software for monitoring general health; mobile apps, namely downloadable satellite imagery photo-interpretation software, for medical imaging, monitoring skin conditions and monitoring of treatment of skin conditions in the field of medicine and healthcare; web application and server software for medical imaging, monitoring skin conditions and monitoring of treatment of skin conditions in the field of medicine and healthcare, managing patient medical records; software and applications for mobile devices, namely downloadable GPS software; software related to handheld digital electronic devices, namely GPS receivers; downloadable smart phone application software, namely downloadable application software for monitoring patient health conditions, vital statistics, sunlight exposure, skin conditions, oxygen levels, vitamin D status, hydration, caloric intake, drug dose administration; downloadable mobile applications for use with wearable computer devices, namely downloadable mobile applications for use with wearable activity trackers, temperature sensors, heat sensors, light sensors, optical sensors, compass, inertial sensors; software for processing images, graphics, audio, video and text, namely image recognition software, voice-recognition software, document scanner software, camera software; image recognition software; medical image management software; software for processing digital images; computer programs for editing images, sound and video; satellite imagery photointerpretation software, namely downloadable computer programs and software for image processing; image transmission apparatus, namely optical transmitters; wireless communication devices for voice, data, or image transmission, namely smartphones; image capturing and developing devices, namely image scanners; humanoid robots with artificial intelligence; tablet computer; tablet covers; educational tablet applications, namely downloadable applications for tablet computers containing information on skin diseases, skin care, monitoring of treatment of skin conditions in the field of medicine and healthcare; wireless headsets for tablet computers; GPS software, namely software for GPS navigation systems; GPS receivers; GPS transmitters; GPS navigation devices consisting of computers, computer software, transmitters, receivers, and network interface devices; digital notepads; digital storage media namely external computer hard drives; personal digital assistants; digital sensory devices namely motion detectors, heat sensors, solar radiation sensors, temperature sensors, photo sensors, compass, inertial sensors; digital measuring apparatus, namely digital thermometers not for medical purposes; downloadable computer software for remote monitoring and analysis, namely software for monitoring qualitative medical data of patients for use in medical referral, diagnosis and treatment; wearable monitors namely wearable activity trackers with heart rate monitoring function and pulse rate monitoring functions, body attitude and motion monitoring functions, in-out door position discrimination functions; multifunctional sleep monitors for displaying, measuring, and uploading user sleep information, namely, motion, position, breathing, respiration, heart rate, quality of sleep, hours slept, and heart and respiration issues to the Internet; satellite receivers; satellite processors; satellite transmitters; satellite navigational instruments, namely satellite navigation devices; satellite communications apparatus, namely satellite receivers, satellite telephones, satellite transmitters, satellite antennas; sensors, namely temperature sensors, light sensors, optical sensors, electronic sensors for measuring solar radiation; sensors for monitoring physical movements; touchscreen sensors; biochip sensors; heat sensors; measuring sensors, namely distance sensors, position sensors, proximity sensors; temperature sensors; light sensors; optical sensors; sensors for measuring instruments, namely sensors for measuring dimensions of an object; optical apparatus and instruments, namely microscope, telescope, binoculars, micro lenses, polarized illuminator and filters, stereographic cameras, IR cameras and lenses; eyeglasses; sunglasses; cases for spectacles and sunglasses; mobile telephone covers and straps.

**Class 10**

(2) Medical and veterinary apparatus and instruments, namely medical optical light and IR radiation instruments; medical instruments, namely lasers for medical purposes, thermometers for medical purposes, heartbeat measuring apparatus, radiotherapy apparatus, magnetic resonance imaging diagnostic apparatus, optical tomography diagnostics apparatus, optical coherence diagnostics apparatus; diagnostic imaging apparatus for medical use, namely medical ultrasound machines, magnetic resonance imaging diagnostic apparatus, optical tomography diagnostics apparatus, optical coherence diagnostics apparatus; apparatus for drug administration, namely dermatological creams dispensers; medical electrodes; medical testing instruments, namely heart rate monitors, blood pressure monitors, pulse meters, hemoglobin and melanin skin meters; electrodes for medical use; medical apparatus and devices, namely electronic light therapy machines for the skin; lasers for medical use; temperature sensors for medical use; electronic analyzers for medical purposes, namely for testing and analyzing chemical and biological substances for the presence, absence, or quantity of target chemicals, biologics, contaminants, substances on and into the skin; measuring devices for medical use, namely devices for measuring vitamin level in the blood, hemoglobin and melanin in the skin; photometric instruments for medical use, namely, infrared thermometers for medical purposes and skin optical properties diagnostics; temperature monitors for medical use; analytical instruments for medical use, namely analytical instruments for sensing skin temperature; telemetry devices for medical applications, namely telemeters for use in the medical field; infrared apparatus for medical purposes, namely infrared thermometers for medical purposes, infrared radiator units for therapeutic purposes; ultrasound apparatus for medical purposes; laser instruments for medical use; telemetry apparatus for medical use, namely telemeters consisting of a sensor, a transmission path, a display, and a recording device for use in the medical field; electronic stimulator for medical use, namely electronic muscle and skin stimulatory for medical purposes, electronic nerve stimulators for medical purposes; test electrodes for medical use; pulse meters for medical purposes; skin temperature indicators for medical use; diagnostic ultrasound apparatus for medical use; electronic heart rate monitors for medical purposes; electrodes for use with medical apparatus; spectrum analyzers for use in medical diagnosis, namely high frequency electromagnetic therapy apparatus, analyzer for bacterial identification for medical purposes, low frequency electromagnetic therapy apparatus all for skin disease detection and classification; filters for ultraviolet rays, for medical purposes; laser light treatment instruments for medical use; light sources for medical use, namely lamps for medical purposes; electronic blood pressure recorders for medical use; wearable walking assistive robots for medical purposes; medical instruments for use in relation to hearing, namely medical hearing instruments, hearing aids; ultrasonic apparatus for medical use in scanning the body, namely ultrasonic medical diagnostic apparatus; body mass index measuring devices for medical use, namely body fat monitors; patient monitoring sensors and alarms, namely alarms for sending patient vital statistics, heartbeat, oxygen levels, hydration levels, solar therapeutic light dose level, UV solar light dose level; exercise apparatus for medical rehabilitative purposes namely heart monitors, abdominal belts for medical purposes; weight training apparatus adapted for medical use, namely, exercise footwear for medical rehabilitation purposes, abdominal belts for medical purposes, electronic heart rate monitors for use during physical exercises; medical test kits comprising diagnostic apparatus for medical use, namely activity trackers for skin properties diagnostics.

## **Services**

### **Class 38**

(1) Telecommunication services, namely providing multiple user access to global computer information networks for the transfer and dissemination of patient medical, diagnostic and treatment information, providing access to a global computer network and internet access; digital



transmission services, namely electronic transmission of text messages, voice messages, videos, images, medical information, patient records, webinars, among users of computers via a global computer network; digital communications services, namely providing email and instant messaging services; wireless digital messaging services; satellite transmission, namely satellite telephone transmission, satellite television transmission, satellite data link for medical images transmission; satellite video conferencing services; satellite communications services, namely electronic transmission of text messages, voice messages, medical information, patient records, videos, images, webinars via a satellite; providing access to internet forums; providing access to internet portals for third parties; providing access to a blog, chatroom, bulletin board or discussion service, namely providing access to an internet discussion website featuring a blog, online chatrooms and electronic bulletin boards for the electronic exchange of messages, comments and multimedia content among users.

### **Class 42**

(2) Scientific and technological services and research and design relating thereto, namely software as a service featuring online non-downloadable software for medical imaging, monitoring skin conditions and monitoring of treatment of skin conditions in the field of medicine and healthcare, managing patient medical records; industrial analysis and industrial research services, namely medical research services; design and development of computer hardware and software; medical and pharmacological research services; biological research, clinical research and medical research; clinical trials; medical laboratory research; design and development of medical diagnostic apparatus, namely design and development of medical apparatus for the diagnosis of skin diseases, vitamin deficiency; design and development of computer software; writing of computer programs for medical applications namely writing of computer code in the medical field; writing of computer programs for biotechnological applications; software engineering; software development; software research; software design; software installation; software creation; software customisation services; computer software installation; maintenance of software; design of computer software; development of interactive multimedia software; providing technical advice relating to computer hardware and software; consultation services relating to computer software; computer hardware and software design; programming of multimedia applications; development and design of mobile applications; rental of data processing equipment, namely rental of computers, computer systems, web servers; information technology services for the pharmaceutical and healthcare industries, namely computer software design and development services, consultation services relating to computer software; computer programming in the medical field; electronic storage of medical records; medical laboratories, namely medical research laboratory services; management of internet portals relating to medical and scientific topics; design and development of wireless data transmission apparatus, instruments and equipment, namely design and development of wireless computer networks; hosting of digital content, namely on-line journals and blogs.

### **Claims**

Priority Filing Date: November 07, 2019, Country or Office: EUIPO (EU), Application No: 018148529 in association with the same kind of goods and in association with the same kind of services

**Application Number** 2,026,563  
**International Registration Number** 1528790A  
**Language of Application** English

**Filing Date** 2019-12-17

## APPLICANT AND AGENT DETAILS

### Applicant

BGC PARTNERS, L.P.  
499 Park Avenue  
New York NY 10022  
UNITED STATES OF AMERICA

### Agent

GOODMANS LLP  
ATTN: INTELLECTUAL PROPERTY GROUP,  
BAY ADELAIDE CENTRE, 333 BAY STREET,  
SUITE 3400, TORONTO, ONTARIO, M5H2S7

## TRADEMARK DETAILS

### Trademark Type

Design

### Visual Representation

**AUREI**

### Services

#### Class 35

(1) Advertising the goods and services of others; commercial business management; commercial administration; office functions namely typing, secretarial and clerical services; commercial business services, namely research in the commercial field and commercial data analysis; commercial information services, namely compilation and publication of financial information regarding currencies, securities, commodities, financial instruments, investments, financial markets, futures, options, swaps and derivative products.

#### Class 36

(2) Financial services, namely operations for transactions and exchanges of financial instruments, securities, commodities, futures, options, forward purchase and sale contracts, swaps and derivative products; financial investment brokerage services; securities brokerage services; commodity and securities exchange services; brokerage of securities, commodities, futures, options, forward purchase and sale contracts, swaps and derivative products; financial services, namely linking, routing, processing and execution of transactions regarding financial instruments, securities, commodities, futures, options, forward purchase and sale contracts, swaps and other derivative products; banking services; financial transaction services, namely assistance to third parties in carrying out financial transactions concerning shares, bonds, funds, securities, cash and

financial investment; provision of secure services for processing of financial transactions and payments, clearing and reconciliation of financial transactions; capital investment services; debt market and debt capital market services, namely, provision of advice on the raising of loans for acquisitions, refinancing of existing debts and restructuring of existing debts; financial research services; financial and fiscal appraisals; financial and fiscal assessments; financial analysis; financial advisory services, namely financial evaluation for investment purposes, financial forecasting, financial management and financial planning; financial order execution service for third parties, namely execution of securities transactions; maintenance and management of securities portfolio accounts on behalf of third parties; investment consultancy; provision of financial information relating to making available financial trading facilities, independent financial trading facilities, financial betting, stock exchange services, brokerage services and securities brokerage services; provision of financial information, namely regarding securities, commodities, financial instruments, investments, financial markets, futures, options, swaps and derivative products.

**Application Number** 2,026,630  
**International Registration Number** 1528571  
**Language of Application** English

**Filing Date** 2020-02-06

## APPLICANT AND AGENT DETAILS

### Applicant

Manfred Roth  
Felbenstr. 10  
72145 Hirrlingen  
GERMANY

### Agent

ANGLEHART ET AL.  
1939 DE MAISONNEUVE OUEST,  
MONTRÉAL, QUEBEC, H3H1K3

## TRADEMARK DETAILS

# Xellar

### Trademark Type

Standard Characters

### Goods

#### Class 07

Integrated metal roll forming machines and their individual components, namely, punching machines, welding machines, profiling machines, cut-to-length machines, and their spare parts, components and accessories, not including punching machines, welding machines, profiling machines and cut-to-length machines for agricultural purposes.

### Claims

Priority Filing Date: August 08, 2019, Country or Office: GERMANY, Application No: 30 2019 110 341 in association with the same kind of goods

**Application Number** 2,028,193  
**International Registration Number** 1530549  
**Language of Application** English

**Filing Date** 2020-04-02

## APPLICANT AND AGENT DETAILS

### Applicant

BioClinica, Inc.  
211 Carnegie Center Drive  
Princeton NJ 08540  
UNITED STATES OF AMERICA

### Agent

GOWLING WLG (CANADA) LLP  
550 BURRARD STREET, SUITE 2300,  
VANCOUVER, BRITISH COLUMBIA, V6C2B5

## TRADEMARK DETAILS

# WEBHEART

### Trademark Type

Standard Characters

### Services

#### Class 42

Providing online non-downloadable software for the management, processing, analysis, and reporting of medical test results, medical diagnostic test results, cardiovascular safety and efficacy data; hosting a website, namely web portals featuring online, non-downloadable software for the management of clinical trials and clinical trial data, secure storage of clinical trial data, and analysis of clinical data and preparation of reports regarding same; cloud computing featuring software for acquiring, displaying, measuring, secure storage and managing of medical test results and medical diagnostic test results, and for documenting review, findings and annotations regarding medical test results and medical diagnostic test results; cloud computing featuring software for managing the logistics, tracking and shipping of goods used in clinical trials; scientific medical research; medical research; tracking and reporting on the results of clinical trials; leasing of computers and computer tablets loaded with clinical trial management software; providing technical advice regarding the installation and use of a web-based clinical trial management software platform.

### Claims

Priority Filing Date: December 03, 2019, Country or Office: UNITED STATES OF AMERICA, Application No: 88713242 in association with the same kind of services

**Application Number** 2,029,442  
**International Registration Number** 1531642  
**Language of Application** English

**Filing Date** 2020-01-03

## APPLICANT AND AGENT DETAILS

### Applicant

Inovus Ltd  
Unit 14, Wharton Street, Sherdley Road  
Industrial Estate, ST. HELENS  
Merseyside WA9 5AA  
UNITED KINGDOM

### Agent

HEIDI JENSEN  
(JENSEN IP), 234 - 38 Auriga Drive, Ottawa,  
ONTARIO, K2E8A5

## TRADEMARK DETAILS

# INOVUS

### Trademark Type

Standard Characters

### Goods

#### Class 09

(1) Resuscitation mannequins; downloadable videos for medical training and tuition containing information and instruction on the use of medical simulators in the field of medical procedure and surgical training; headsets for virtual reality and augmented reality concerning medical training; medical diagnostic apparatus, namely, simulators for use as teaching aids for medical procedures in the fields of endoscopy, laparoscopy, critical care, hysteroscopy, bronchoscopy, cystoscopy, and general surgery; medical diagnostic simulators for use as teaching aids for medical procedures, namely, laparoscopic simulators, hysteroscopic simulators, endoscopic simulators, bronchoscopic simulators, and cystoscopic simulators; software for controlling and managing user information and data relating to the tuition, educational courses and practical training of medical students and medical practitioners; virtual reality software for medical procedure and surgical training using medical simulators

#### Class 10

(2) Models of internal organs for medical training and tuition; medical devices and instruments used for training purposes, namely, grasping devices, scissors, needle holders, and ultrasonic medical diagnostic apparatus for endoscopy, laparoscopy, critical care, hysteroscopy, bronchoscopy, cystoscopy, and for general surgery training purposes; medical devices and instruments, namely, grasping devices, scissors, needle holders, and ultrasonic energy devices, all for use with medical simulators; models of human organs, namely, abdominal, pelvic and thoracic organs and their associated pathologies and models of the musculoskeletal system for medical training

#### Class 16

(3) Printed medical texts and training materials, namely course curricula, work and answer sheets, workbooks, manuals, research reports, instruction materials for the use of medical simulators for medical procedure training; medical publications and journals containing information and instruction on the use of medical simulators in the field of medical procedure and surgical training

**Services****Class 41**

(1) Medical training and teaching; providing on-line videos [non-downloadable] for medical tuition; online computer-based medical simulation training in the field of surgical and medical procedures

**Class 42**

(2) Design and development of virtual reality and augmented software for use with medical simulators; hosting of websites for non-downloadable videos for medical tuition; hosting of online platform for medical training purposes

**Application Number** 2,029,980  
**Language of Application** English

**Filing Date** 2020-05-22

## APPLICANT AND AGENT DETAILS

### Applicant

LG H&H Co., LTD.  
58, Saemunan-ro, Jongno-gu  
Seoul,  
REPUBLIC OF KOREA

### Agent

BORDEN LADNER GERVAIS LLP  
World Exchange Plaza, 100 Queen Street,  
Suite 1300, Ottawa, ONTARIO, K1P1J9

## TRADEMARK DETAILS

# Morning Aura Ultra Grease Cutter

### Trademark Type

Standard Characters

### Goods

#### Class 03

Laundry detergents for household use; detergents for kitchen purposes, namely, dishwashing detergents and dish detergents; detergents for household use; fragrances for household purposes; fabric softeners for laundry use; antistatic preparations for household purposes namely, anti-static dryer sheets; drying agents for dishwashing machines; detergents for machine dishwashing



**Application Number** 2,030,975  
**International Registration Number** 1532924  
**Language of Application** English

**Filing Date** 2020-04-24

## APPLICANT AND AGENT DETAILS

**Applicant**  
NOVARTIS AG  
CH-4002 Basel  
SWITZERLAND

**Agent**  
SMART & BIGGAR LP  
1100-150 York street, TORONTO, ONTARIO,  
M5H3S5

## TRADEMARK DETAILS

# RAPIQUITY

**Trademark Type**  
Standard Characters

### Goods

#### Class 05

Pharmaceutical preparations for the prevention and treatment of the central nervous system, namely, central nervous system infections, brain diseases, central nervous system movement disorders, ocular motility disorders, spinal cord diseases; pharmaceutical preparations for the prevention and treatment of immunologic diseases, namely, autoimmune diseases, immunologic deficiency syndromes; pharmaceutical preparations for the prevention and treatment of cardiovascular diseases; pharmaceutical preparations for the prevention and treatment of diabetes; pharmaceutical preparations for the prevention and treatment of metabolic disorders, namely, diabetes, obesity, hyperlipidemia, insulin resistance, metabolic syndrome; antiinflammatories; pharmaceutical preparations for the prevention and treatment of disorders of the respiratory system; pharmaceutical preparations for the prevention and treatment of disorders of the musculo-skeletal system, namely, connective tissue diseases, bone diseases, spinal diseases, back pain, fractures, sprains, cartilage injuries; pharmaceutical preparations for the prevention and treatment of genitourinary diseases, namely, urological diseases, infertility, sexually transmitted diseases, inflammatory pelvic diseases; pharmaceutical preparations for use in dermatology, namely, dermatitis, skin pigmentation diseases, sexually transmitted diseases; pharmaceutical preparations for use in oncology; pharmaceutical preparations for use in hematology, namely for the treatment of blood disorders; pharmaceutical preparations for use in tissue and organ transplantation; pharmaceutical preparations for use in ophthalmology; pharmaceutical preparations for use in gastroenterology; pharmaceutical preparations for prevention and treatment of ocular disorders and diseases; anti-infectives, antibacterials, antivirals, antibiotics, systemic and topical antifungals.

### Claims

Priority Filing Date: November 22, 2019, Country or Office: SWITZERLAND, Application No: 743633 in association with the same kind of goods

**Application Number** 2,030,978  
**International Registration Number** 1532898  
**Language of Application** English

**Filing Date** 2020-04-24

## APPLICANT AND AGENT DETAILS

**Applicant**  
NOVARTIS AG  
CH-4002 Basel  
SWITZERLAND

**Agent**  
SMART & BIGGAR LP  
1100-150 York street, TORONTO, ONTARIO,  
M5H3S5

## TRADEMARK DETAILS

# JOVAYBA

**Trademark Type**  
Standard Characters

### Goods

#### Class 05

Pharmaceutical preparations for the prevention and treatment of the central nervous system, namely, central nervous system infections, brain diseases, central nervous system movement disorders, ocular motility disorders, spinal cord diseases; pharmaceutical preparations for the prevention and treatment of immunologic diseases, namely, autoimmune diseases, immunologic deficiency syndromes; pharmaceutical preparations for the prevention and treatment of cardiovascular diseases; pharmaceutical preparations for the prevention and treatment of diabetes; pharmaceutical preparations for the prevention and treatment of metabolic disorders, namely, diabetes, obesity, hyperlipidemia, insulin resistance, metabolic syndrome; antiinflammatories; pharmaceutical preparations for the prevention and treatment of disorders of the respiratory system; pharmaceutical preparations for the prevention and treatment of disorders of the musculo-skeletal system, namely, connective tissue diseases, bone diseases, spinal diseases, back pain, fractures, sprains, cartilage injuries; pharmaceutical preparations for the prevention and treatment of genitourinary diseases, namely, urological diseases, infertility, sexually transmitted diseases, inflammatory pelvic diseases; pharmaceutical preparations for use in dermatology, namely, dermatitis, skin pigmentation diseases, sexually transmitted diseases; pharmaceutical preparations for use in oncology; pharmaceutical preparations for use in hematology, namely for the treatment of blood disorders; pharmaceutical preparations for use in tissue and organ transplantation; pharmaceutical preparations for use in ophthalmology; pharmaceutical preparations for use in gastroenterology; pharmaceutical preparations for prevention and treatment of ocular disorders and diseases; anti-infectives, antibacterials, antivirals, antibiotics, systemic and topical antifungals.

### Claims

Priority Filing Date: November 22, 2019, Country or Office: SWITZERLAND, Application No: 739207 in association with the same kind of goods

**Application Number** 2,030,979  
**International Registration Number** 1532897  
**Language of Application** English

**Filing Date** 2020-04-24

## APPLICANT AND AGENT DETAILS

**Applicant**  
NOVARTIS AG  
CH-4002 Basel  
SWITZERLAND

**Agent**  
SMART & BIGGAR LP  
1100-150 York street, TORONTO, ONTARIO,  
M5H3S5

## TRADEMARK DETAILS

# REGTRUZA

**Trademark Type**  
Standard Characters

### Goods

#### Class 05

Pharmaceutical preparations for the prevention and treatment of the central nervous system, namely, central nervous system infections, brain diseases, central nervous system movement disorders, ocular motility disorders, spinal cord diseases; pharmaceutical preparations for the prevention and treatment of immunologic diseases, namely, autoimmune diseases, immunologic deficiency syndromes; pharmaceutical preparations for the prevention and treatment of cardiovascular diseases; pharmaceutical preparations for the prevention and treatment of diabetes; pharmaceutical preparations for the prevention and treatment of metabolic disorders, namely, diabetes, obesity, hyperlipidemia, insulin resistance, metabolic syndrome; antiinflammatories; pharmaceutical preparations for the prevention and treatment of disorders of the respiratory system; pharmaceutical preparations for the prevention and treatment of disorders of the musculo-skeletal system, namely, connective tissue diseases, bone diseases, spinal diseases, back pain, fractures, sprains, cartilage injuries; pharmaceutical preparations for the prevention and treatment of genitourinary diseases, namely, urological diseases, infertility, sexually transmitted diseases, inflammatory pelvic diseases; pharmaceutical preparations for use in dermatology, namely, dermatitis, skin pigmentation diseases, sexually transmitted diseases; pharmaceutical preparations for use in oncology; pharmaceutical preparations for use in hematology, namely for the treatment of blood disorders; pharmaceutical preparations for use in tissue and organ transplantation; pharmaceutical preparations for use in ophthalmology; pharmaceutical preparations for use in gastroenterology; pharmaceutical preparations for prevention and treatment of ocular disorders and diseases; anti-infectives, antibacterials, antivirals, antibiotics, systemic and topical antifungals.

### Claims

Priority Filing Date: November 20, 2019, Country or Office: SWITZERLAND, Application No: 739046 in association with the same kind of goods

**Application Number** 2,031,064  
**International Registration Number** 1422877  
**Language of Application** English

**Filing Date** 2020-05-12

## APPLICANT AND AGENT DETAILS

### Applicant

Selentus Science Limited  
3 Castlegate,  
Grantham  
Lincolnshire NG31 6SF  
UNITED KINGDOM

### Agent

NELLIGAN O'BRIEN PAYNE LLP  
300-50 O'CONNOR STREET, OTTAWA,  
ONTARIO, K1P6L2

## TRADEMARK DETAILS

# TENATAC

### Trademark Type

Standard Characters

### Goods

#### Class 10

Adhesive sutures; suture materials; surgical sponges; haemostatic sponges for surgical and medical use; sponge material for surgical use.

**Application Number** 2,032,023  
**Language of Application** English

**Filing Date** 2020-06-04

## APPLICANT AND AGENT DETAILS

### Applicant

bclMC Realty Corporation  
55 University Avenue  
Suite 300  
Toronto  
ONTARIO  
M5H2H7

### Agent

FASKEN MARTINEAU DUMOULIN LLP  
333 BAY STREET, SUITE 2400, BAY  
ADELAIDE CENTRE, BOX 20, TORONTO,  
ONTARIO, M5H2T6

## TRADEMARK DETAILS

### Trademark Type

Design

### Visual Representation



### Services

#### Class 35

(1) Shopping centre administration services; food concession stands

#### Class 36

(2) Leasing of shopping mall space; leasing for others of residential condominiums; real estate management services; leasing of office space; management of office buildings

#### Class 37

(3) Construction of residential and commercial properties; development of residential and commercial properties

#### Class 39

(4) Transportation of passengers by bus

#### Class 41

(5) Art exhibition services; curating art projects; providing recreational areas in the nature of play areas for children; providing theatre facilities for movies, shows, plays, and music

#### Class 43

(6) Fast food restaurant services; providing food and drink in food halls; providing community centers for social gatherings and meetings

**Application Number** 2,032,024  
**Language of Application** English

**Filing Date** 2020-06-04

## APPLICANT AND AGENT DETAILS

### Applicant

bclMC Realty Corporation  
55 University Avenue  
Suite 300  
Toronto  
ONTARIO  
M5H2H7

### Agent

FASKEN MARTINEAU DUMOULIN LLP  
333 BAY STREET, SUITE 2400, BAY  
ADELAIDE CENTRE, BOX 20, TORONTO,  
ONTARIO, M5H2T6

## TRADEMARK DETAILS

### Trademark Type

Design

### Visual Representation



### Colour Claim

Colour is claimed as a feature of the trademark. The letter C is green. The upper circle of the clover design is green, the left and right circles of the clover design and the joining line are orange and the bottom circle of the clover device is blue.

### Services

#### Class 35

(1) Shopping centre administration services; food concession stands

#### Class 36

(2) Leasing of shopping mall space; leasing for others of residential condominiums; real estate management services; leasing of office space; management of office buildings

#### Class 37

(3) Construction of residential and commercial properties; development of residential and commercial properties

#### Class 39

(4) Transportation of passengers by bus

#### Class 41

(5) Art exhibition services; curating art projects; providing recreational areas in the nature of play areas for children; providing theatre facilities for movies, shows, plays, and music

#### Class 43

(6) Fast food restaurant services; providing food and drink in food halls; providing community centers for social gatherings and meetings

**Application Number** 2,033,546  
**International Registration Number** 1535420  
**Language of Application** French

**Filing Date** 2020-04-27

## APPLICANT AND AGENT DETAILS

### Applicant

Société des Produits Nestlé S.A.  
CH-1800 Vevey  
SUISSE

### Agent

EMMANUELLE PARÉ  
CP 161, Saint-Philippe BP, QUÉBEC, J0L2K0

## TRADEMARK DETAILS

# YOGHIES

### Trademark Type

Standard Characters

### Goods

#### Class 30

Cocoa and cocoa-based preparations, namely cocoa powder, cocoa-based beverages, cocoa mix; chocolate; chocolate products, namely chocolate confectionery, chocolate bars, chocolate-covered nuts, chocolate mousses, chocolate topping, hot chocolate, chocolate sauce, chocolate pastes, cocoa spread, chocolate-based preparations, namely chocolate syrup, chocolate spreads, chocolate-based snack foods, chocolate-based dips; chocolate-based beverages, namely non-alcoholic chocolate beverages; confectionery, namely sweet confectionery, candy; sugar; chewing gums other than for medical use; baked goods, namely bread, pastries; biscuits, cakes, cookies, wafers, caramels.

### Claims

Priority Filing Date: December 20, 2019, Country or Office: SWITZERLAND, Application No: 741434 in association with the same kind of goods



**Application Number** 2,033,589  
**International Registration Number** 1535742  
**Language of Application** English

**Filing Date** 2020-05-07

## APPLICANT AND AGENT DETAILS

### Applicant

Dulce Bestia LLC  
100 Whitefish Hills Drive  
Whitefish MT 59937  
UNITED STATES OF AMERICA

### Agent

BORDEN LADNER GERVAIS LLP  
World Exchange Plaza, 100 Queen Street,  
Suite 1300, Ottawa, ONTARIO, K1P1J9

## TRADEMARK DETAILS

# SNOW BEAST

### Trademark Type

Standard Characters

### Goods

#### Class 09

(1) Sport goggles; sunglasses; sports helmets; eyeglasses; eyewear cases; eyewear pouches; eyewear accessories, namely, straps, neck cords and head straps; ear buds; headphones; carrying cases and protective covers for personal electronic devices, namely, cell phones, portable media players, personal digital assistants, tablet computers, laptops and electronic reading devices; downloadable application software for mobile devices, namely, for mobile phones, personal digital assistants, tablet computers, laptops and digital book readers for accessing and organizing information in the fields of pets, beauty, lifestyle, travel, music, art, movies, live entertainment, namely, live comedy shows, live musical concerts, live magic shows, film, news, sports, charitable fundraising and global humanitarian issues; downloadable mobile and computer application software for online shopping.

#### Class 14

(2) Jewelry; sport watches for skiing; bracelets; jewelry chains of precious metal for bracelets; watches; watch bands; watch straps; finger rings; jewelry chains; jewelry boxes; jewelry charms; necklaces; earrings; jewelry brooches; jewelry pins; watch cases in the nature of cases adapted for holding watches; decorative boxes made of precious metal; jewelry cases.

#### Class 18

(3) All-purpose sports bags; backpacks; fanny packs; purses; pouches for carrying make-up; pouches for holding keys; pouches for holding personal items, namely, coins, personal compact mirrors, cosmetic brushes, and hair brushes; handbags; messenger bags; tote bags; duffle bags; shoulder bags; clutch bags; wallets; key cases; luggage; knapsacks; rucksacks; umbrellas.

#### Class 25

(4) Men's, women's and children's clothing, namely, jackets, pants, shirts, sweaters, vests, skirts, thermal underwear, tights, socks, gloves, mittens, hats, ski masks, gaiters, suspenders, belts, jumpers, warm-up suits, leotards, leggings, leg warmers, swimming trunks, scarves, shawls, loungewear, sleep wear, boots, headwear, namely, hats, caps, bandannas, toques, beanies and headbands, boots.

**Services****Class 35**

Retail store services featuring jewelry, eyewear, bags, namely, sports bags, bags adapted for ski boots, bags specially adapted for skis, bags specially adapted for snowboards, bags specially adapted for sports equipment, backpacks, duffel bags, athletic bags, clothing and related sports accessories, namely, sports equipment

**Claims**

Priority Filing Date: November 08, 2019, Country or Office: UNITED STATES OF AMERICA, Application No: 88685718 in association with the same kind of goods and in association with the same kind of services

**Application Number** 2,034,682  
**International Registration Number** 1536522  
**Language of Application** English

**Filing Date** 2020-02-06

## APPLICANT AND AGENT DETAILS

### Applicant

Triple A Finance GmbH & Co. KG  
Am Lenkwerk 3  
33609 Bielefeld  
GERMANY

### Agent

DEETH WILLIAMS WALL LLP  
150 YORK STREET, SUITE 400, TORONTO,  
ONTARIO, M5H3S5

## TRADEMARK DETAILS

### Trademark Type

Design

### Visual Representation



### Goods

#### Class 05

(1) Sexual stimulant gels.

#### Class 10

(2) Massage apparatus, namely, vibrators massagers and masturbators massagers; manual massage instruments, namely, massage rollers and massaging sticks; electrically operated massagers, namely, electric vibrating massagers; contraceptive devices, namely, contraceptive

diaphragms and contraceptive coils; condoms; sex aids, namely, sex dolls, artificial penises, penis enlargers, and artificial vaginas; sex toys; personal vibrators, being adult sexual aids; stimulators, being adult sexual aids, namely, Ben Wa balls, dildos, and penis rings.

## **Services**

### **Class 35**

Retail services, wholesale services, mail order services and online mail order services for soap, cosmetics except cotton wool and cotton swabs for cosmetic purposes, cleaning and fragrancng preparations, essential oils, air fragrancng preparations, perfumed tissues, sexual stimulant gels, contraceptive appliances, sexual aids, outfits, headgear and footwear; retail services, wholesale services, mail order services and online mail order services for massage apparatus, namely, vibrators massagers and masturbators massagers, manual massage instruments, namely, massage rollers and massaging sticks, electrically operated massagers, namely, electric vibrating massagers, contraceptive devices, namely, contraceptive diaphragms and contraceptive coils, condoms, sex aids, namely, sex dolls, artificial penises, penis enlargers, and artificial vaginas, sex toys, personal vibrators, being adult sexual aids, stimulators, being adult sexual aids, namely, Ben Wa balls, dildos, and penis rings; marketing services, namely, providing marketing strategies for others; market research and market analysis; presentation of businesses and goods on the Internet, namely, advertising the businesses and goods of others via the Internet; computerized file management; mediation of trade business for third parties; sales demonstration for others; advertising the goods and services of others in periodicals, brochures and newspapers; promoting the goods and services of others through the mailing of loyalty coupons, distribution of discount cards and vouchers, and the administration of loyalty reward schemes in order to attract customers and customer loyalty; commercial administration of the licensing of the goods and services of others; advertising by mail order for others; arranging and conducting cultural events and community social events for advertising the goods and services of others; organization of exhibitions in the field of sex toys and sexual stimulation aids for commercial and advertising purposes; billposting; shop window dressing; direct mail advertising of the goods and services of others; preparation and presentation of audio visual displays in the field of sex toys and sexual stimulation aids for advertising purposes; organisation of trade fairs in the field of sex toys and sexual stimulation aids for commercial and advertising purposes; sample distribution; market research for advertising the goods and services of others; analysis of advertising campaigns for the products and services of others.

## **Claims**

Priority Filing Date: August 09, 2019, Country or Office: GERMANY, Application No: 30 2019 110 413 in association with the same kind of goods and in association with the same kind of services

**Application Number** 2,034,751  
**International Registration Number** 1536149  
**Language of Application** English

**Filing Date** 2020-03-16

## APPLICANT AND AGENT DETAILS

### Applicant

FURYU CORPORATION  
2-3, Uguisudani-cho,  
Shibuya-ku  
Tokyo 150-0032  
JAPAN

### Agent

MARKS & CLERK  
33 Yonge Street, , Suite 300, Toronto,  
ONTARIO, M5E1G4

## TRADEMARK DETAILS

# FURYU

### Trademark Type

Standard Characters

### Foreign Character Translation

The translation provided by the applicant of the word FURYU is elegant and tasteful.

### Goods

#### Class 09

(1) Photographic cameras; photo booths; coin-operated mechanisms for operating photo booths; computer game software; computer game cartridges; downloadable interactive entertainment software for playing computer games; computer programs and software for image processing used for mobile phones; computer game software downloadable from a global computer network; electronic game software for wireless devices.

#### Class 28

(2) Dolls; collectable toy figures; toy figures; stuffed toys; rag dolls; arcade video game machines.

### Services

#### Class 35

(1) Advertising agency services; marketing research; retail services and wholesale services for toys, dolls, game machines; retail services and wholesale services for photo booths; retail services and wholesale services for photographic cameras and photographic supplies; retail services and wholesale services for downloadable image files.

#### Class 41

(2) Entertainment services in the nature of non-downloadable videos and images featuring television shows and movies transmitted via wireless computer networks; providing amusement parks; providing amusement arcade services; online computer games; providing interactive multiplayer online computer games via a global network; photography services; photography services with a coin-operated photo booths.

#### Class 42

(3) Providing online non-downloadable software, namely, computer game software; electronic storage of photographs.

**Claims**

Priority Filing Date: March 05, 2020, Country or Office: JAPAN, Application No: 2020-023890 in association with the same kind of goods and in association with the same kind of services

**Application Number** 2,035,993  
**International Registration Number** 1537919  
**Language of Application** English

**Filing Date** 2020-01-22

## APPLICANT AND AGENT DETAILS

### Applicant

GROWINGS ROBOTX LTD  
6 HaMaalit Street,  
Kadima  
6092000 Tzoran  
ISRAEL

### Agent

FASKEN MARTINEAU DUMOULIN LLP  
Tour de la Bourse, Suite 3500, P.O. box 242,  
800, Place Victoria, Montréal, QUEBEC,  
H4Z1E9

## TRADEMARK DETAILS

### Trademark Type

Design

### Visual Representation



### Goods

#### Class 07

Agricultural machines, namely, agricultural aerial machines for spreading seeds, fertilizers, herbicides, insecticides, pesticides, aerial top dressings and other agricultural chemicals and fluids, and crop dusting; agricultural machines for aerial and surface spreading of fertilizers and other agricultural chemicals, namely, herbicides, pesticides, aerial top dressings, crop protection products and products for the extermination of vermin; insecticide spraying agricultural machines

### Services

#### Class 44

Vermin exterminating for agriculture; provision of information relating to the aerial and surface spreading of fertilizers and other agricultural chemicals; destruction of parasites, vermin exterminating and weed killing for agriculture; pest control services for agriculture; aerial and surface spreading of fertilizers and other agricultural chemicals; weed killing for agriculture; aerial spraying of crop protection products for agricultural purposes; aerial spreading of fertilizers and other agricultural chemicals; insecticide spraying for agricultural purposes; destruction of parasites for agriculture; aerial agriculture services, namely, spreading of seeds, aerial top dressings and other agricultural chemicals and fluids, and crop dusting; aerial pest control for agricultural purposes; aerial insecticide spraying in agriculture; aerial spreading of fertilizers.

**Claims**

Priority Filing Date: July 22, 2019, Country or Office: ISRAEL, Application No: 318898 in association with the same kind of goods and in association with the same kind of services



**Application Number** 2,036,056  
**International Registration Number** 1537777  
**Language of Application** English

**Filing Date** 2020-03-17

## APPLICANT AND AGENT DETAILS

**Applicant**  
ASSOCIATION FOR PLAY THERAPY, INC.  
401 Clovis Avenue, Suite 107  
Clovis CA 93612  
UNITED STATES OF AMERICA

**Agent**  
CPST INTELLECTUAL PROPERTY INC.  
130 Queens Quay East, East Tower, Suite  
809, Toronto, ONTARIO, M5A0P6

## TRADEMARK DETAILS

**Trademark Type**  
Design

**Visual Representation**





**Services**

**Class 35**

Association services for promoting the interests of providers of play therapy.

**Application Number** 2,036,361  
**International Registration Number** 1215840  
**Language of Application** English

**Filing Date** 2020-06-03

## APPLICANT AND AGENT DETAILS

### Applicant

Rolls-Royce plc  
Kings Place, 90 York Way  
London N1 9FX  
UNITED KINGDOM

### Agent

SMART & BIGGAR LP  
1100-150 York street, TORONTO, ONTARIO,  
M5H3S5

## TRADEMARK DETAILS

### Trademark Type

Design

### Visual Representation



### Goods

#### Class 09

(1) Scientific, nautical, surveying, photographic, cinematographic, optical, measuring and signaling apparatus and instruments, namely, semiconductor chips, conductivity meters, satellite navigation devices for marine vehicles, surveying instruments, electronic distance sensors and meters, meters for measuring electrical resistance; apparatus for recording, transmission or reproduction of sound or images, namely, digital video and voice recorders, digital sound processors, image scanners; recording discs, namely, blank recordable optical discs, CD-Rs and DVD-Rs; data processing equipment, namely, computer hardware; computers; computer application software for

mobile phones, namely, software for use in database management and for accessing, querying and analyzing information stored in databases and data warehouses; computer software in relation to aerospace, marine and power generation, namely, software for use in database management and for accessing, querying and analyzing information stored in databases and data warehouses; electrical integrated control systems for use in the field of power generation; electrical connectors; ultrasonic inspection apparatus, namely, ultrasonic flaw detectors, ultrasonic equipment used to test or inspect damage to aircraft; electronic data processing equipment, namely, computer hardware and software in the field of aircraft and electrical generators for predictive engine and product maintenance; signaling apparatus, namely, signal bells, signal processors, transmitters of electronic signals via satellite, remote control signaling apparatus in the nature of transmitters and receivers of electronic signals via satellite; electrical apparatus and instruments for inspection, namely, optical inspection apparatus for the physical inspection of ships, aircraft, power-generating equipment; computer software for shipboard systems, namely software for the control and monitoring of marine vehicles; electric distribution consoles for steering and control of deck machinery on board ships; video monitors and computer and television screen display monitors for use with onboard navigational systems; computer software for use in steering and control systems for marine vehicles; computer processing equipment, namely, computer central processing units and computers; automatic ships' steering gears; deck operating system software for controlling, monitoring and navigating marine vehicles; launch and recovery system for use on marine vessels comprised of sensors, actuators, and computer hardware; power electric systems comprising motors or generators; electric energy storage system for vehicles excluding motor cars; simulators, namely, flight simulators, marine simulators for the steering and control of marine vehicles, simulators for the steering and control of vehicles; electric magnetic chip detector; software in the field of computational fluid dynamics for analysis and design of turbomachinery; sunglasses; calculators; computer peripherals including multi USB charging ports, computer mice, mouse mats, audio speakers, blank USB flash drives, battery power chargers, computer tablet cases; earphones; cell phone cases; blank recordable DVDs; blank recordable CDs; magnifying lenses; tape measures; glasses cases; reflective clothing for the prevention of accidents.

### **Class 11**

(2) Electric torches for lighting; book lights; igniters for engines; nuclear reactors; nuclear cogeneration plants; atomic piles and nuclear power plants, nuclear generators and parts for the aforesaid goods; installations for processing nuclear fuel and nuclear moderating material.

### **Class 25**

(3) Clothing, namely, anoraks, hats, caps, socks, polo shirts, hoodies, T-shirts, sweatshirts, belts, braces, gilets, jackets, cagoules, jumpsuits in the nature of boiler suits, overalls, aprons, scarves, cravats, gloves, ties, clothes for cycling in the nature of cycling shorts, shoes, and jerseys, cloth bibs, cummerbund.

### **Services**

#### **Class 36**

(1) Insurance services, none of the aforesaid relating to motor cars or their parts and fittings; financial services relating to aero, marine and energy sectors, namely, financial investment and financial planning advice and consultancy, none of the aforesaid relating to motor cars or their parts and fittings.

#### **Class 37**

(2) Repair, maintenance and installation services relating to engines and ships and their parts and fittings, none of the aforesaid relating to motor cars or their parts and fittings; construction, repair,

maintenance, installation and decommissioning services in relation to nuclear reactors, nuclear installations, nuclear generators, nuclear cogeneration plants, atomic piles, nuclear power plants, nuclear processing installations and their constituent parts and components, none of the aforesaid relating to motor cars or their parts and fittings; computer hardware apparatus installation, maintenance and repair, none of the aforesaid relating to motor cars or their parts and fittings.

**Application Number** 2,036,600  
**Language of Application** English

**Filing Date** 2020-06-26

## APPLICANT AND AGENT DETAILS

### Applicant

Shenzhen Smashing Technology Co.,Ltd.  
Room 208, 47#Building, DayunSoftware Town  
Longgang Road, Yuanshan Street, Longgang  
District  
Shenzhen, 518000  
CHINA

### Agent

ANITA MAR  
dba Trademark Angel, Suite 521, 6-2557  
Dougall Avenue, Windsor, ONTARIO, N8X1T5

## TRADEMARK DETAILS

# OsmoHive

### Trademark Type

Standard Characters

### Foreign Character Translation

OsmoHive has no translation in English or French

### Goods

#### Class 25

Tee-shirts; Shirts; Vests; Underclothing; Underpants; Underwear; Bathing trunks; Bathing suits; Shoes; Socks; Leggings (trousers); Sports jerseys; Sports singlets; Corsets (underclothing); sleepwear; thermal underwear

**Application Number** 2,037,990  
**Language of Application** English

**Filing Date** 2020-07-03

## APPLICANT AND AGENT DETAILS

### Applicant

Allogene Therapeutics, Inc.  
210 E. Grand Avenue  
South San Francisco, CA 94080  
UNITED STATES OF AMERICA

### Agent

CLARK WILSON LLP  
900 - 885 WEST GEORGIA STREET,  
VANCOUVER, BRITISH COLUMBIA, V6C3H1

## TRADEMARK DETAILS

# TURBOCAR

### Trademark Type

Standard Characters

### Goods

#### Class 05

Pharmaceutical preparations, namely, preparations for use in the treatment of cancer and tumors; pharmaceutical and biological preparations for immunotherapy, including T Cell therapy

### Claims

Priority Filing Date: January 08, 2020, Country or Office: UNITED STATES OF AMERICA,  
Application No: 88751692 in association with the same kind of goods

**Application Number** 2,038,342  
**Language of Application** French

**Filing Date** 2020-07-07

## APPLICANT DETAILS

### Applicant

Janie Gagné  
205, rue Armand  
J1X 1E9  
Magog  
QUÉBEC  
J1X1E9

## TRADEMARK DETAILS

# Magog Vert

**Trademark Type**  
Standard Characters

### Services

#### Class 35

developing and coordinating volunteer projects for charitable organizations



**Application Number** 2,038,569  
**International Registration Number** 1540289  
**Language of Application** English

**Filing Date** 2019-12-19

## APPLICANT AND AGENT DETAILS

### Applicant

BRIDGESTONE CORPORATION  
1-1, Kyobashi 3-chome,  
Chuo-ku  
Tokyo 104-8340  
JAPAN

### Agent

DEETH WILLIAMS WALL LLP  
150 YORK STREET, SUITE 400, TORONTO,  
ONTARIO, M5H3S5

## TRADEMARK DETAILS

### Trademark Type

Design

### Visual Representation

The image shows the Bridgestone logo, which consists of a stylized 'B' with a white diagonal slash through it, followed by the word 'BRIDGESTONE' in a bold, black, sans-serif font. The logo is partially cut off on the right side.

### Goods

#### Class 09

Computer software for monitoring, analyzing flight data and predicting treadwear of tires; checking (supervision) apparatus and instruments, namely, tire depth gauges, tools to detect cracks on products by means of camera, tools to detect cracks on products by means of light, and tools to detect cracks on products by means of air; holders for hand-held computers; measuring apparatus and instruments, namely, pressure gauges, pressure sensors, lasers for measuring purposes, measuring and testing machines and instruments, namely, sensors and gauges for measuring and testing the temperature and pressure of oil, water, automotive fluids, and air in engines, motors, drive trains, transmissions, and tires; satellite and radio transmitter and receiver apparatus, namely, satellite transmitters and receivers, radio transmitters and receivers; signaling apparatus and instruments, namely, flashing safety lights for vehicles and flashing safety lights for traffic cones; software for operating electronic digital dictionaries; telecommunications installations, networks and apparatus, namely, radio transmitters and receivers, satellite transmitters, GPS transmitters, telephone transmitters, video transmitters, audio- and video-receivers, mobile phones; mounting racks for telecommunications computer hardware; telematics apparatus, namely, wireless Internet-enabled devices in the nature of on-board computers, GPS receivers and GPS transmitters that provide telematics services and have cellular phone function; barcode scanners; two-dimensional code scanners; printers, namely, thermal printers, inkjet printers, laser printers; surveying instruments; computer hardware and software for use with satellite and GPS navigation systems for navigation purposes; computer software for operating satellite navigational systems and global positioning systems [GPS], and for use of global positioning systems [GPS] for

tracking, locating and security of vehicles and objects; computer software for use with route planners, electronic maps and digital dictionaries for navigation purposes; computer terminals, all in particular for the use of navigation systems, route planners, and digital maps; downloadable electronic maps; global positioning system (GPS) consisting of computers, computer software, transmitters, receivers, and network interface devices; location, orientation and navigation, and global positioning systems (GPS) consisting of computers, computer software, transmitters, global positioning system receivers and satellite receivers; mobile computing and operating platforms consisting of data transceivers, wireless networks and gateways for collection and management of data; navigation apparatus for vehicles in the nature of on-board computers; route planners in the form of hand-held personal computers (hand-held computers); satellite navigational systems, namely global positioning systems consisting of satellites, computers, computer software, transmitters, receivers, and network interface devices; computer software for database management in the field of transportation and traffic; software for management and maintenance of groups of vehicles, namely, software for tracking and monitoring vehicles, and for scheduling and management of vehicle maintenance, for use in the field of vehicle management; software for operating route planners; software for in-vehicle navigation and entertainment systems for providing and displaying travel advice on petrol stations, car parks, restaurants, hotels, and car dealers; computer software for displaying orders and vehicle locations on maps; software to indicate maintenance requirements and maintenance scheduling for vehicles; vehicle locating, tracking and security systems comprised of an antennas and radio transmitters to be placed in vehicles; downloadable electronic databases containing information relating to tires, vehicle parts, vehicles and groups of vehicles; electronic publications relating to tires, vehicle parts, vehicles and groups of vehicles; electronic reports relating to tires, vehicle parts, vehicles and groups of vehicles; electronic sensing, checking, monitoring and communication devices used in relation to vehicles, tires, vehicle parts and groups of vehicles, namely, telecommunication devices comprised of receivers, transmitters and computer hardware and software for collecting, tracking, storing, managing, reporting, and transmitting tire and vehicle telematics data; electronic sensors for tires, vehicles and vehicle parts, namely, temperature sensors, pressure sensors, acceleration sensors, distance sensors, velocity sensors, tire abrasion sensors, and road surface condition sensors; downloadable software for arranging and managing subscription services relating to monitoring, maintenance, replacement and purchase of tires and vehicle parts; downloadable software for arranging the replacement, repair, inspection, installation, monitoring, management, maintenance, ordering and purchase of tires, vehicle parts and vehicles; software used in relation to tires, vehicle parts, vehicles and groups of vehicles, namely, computer software for collecting, tracking, storing, managing, reporting, and transmitting tire and vehicle telematics data; downloadable computer software and mobile applications for use in monitoring and tracking tires and tire data, namely, tire deflection data, tire pressure data, tire abrasion data, vehicle speed data, and road surface condition data; computer software for vehicle fleet management; computer software for use in managing, tracking, and optimizing fleet operation costs and productivity based on commercial fleet tire data; computer software for use in monitoring tracking and reporting tire treadwear data, and predicting potential risky driving conditions for tires and allow vehicles to react to such conditions to prevent accident; downloadable computer software and mobile applications for analyzing treadwear of tires based on pictures; accident preventing systems primarily comprising sensors, operating software and computer hardware for measuring and transmitting tire treadwear data; tire treadwear detecting systems primarily comprising treadwear detecting sensors, low tire pressure automatic indicators, electric sensors, signal transmitters, signal receivers, and electronic display interfaces; computer software for reporting the performance and condition of tires in retreading tires; computer software for tire retread dealers to track, photograph, and provide receipts for retreaded tires; computer software for tracking inventory of retread tires;

computer software for information tracking and reporting functions in the retread tire business in the field of customer relationship management, supply chain management, human services, and financial applications, all designed to help businesses in the retread, commercial, retail and wholesale tire industry; tire pressure monitoring systems comprising a computer, pressure sensors, antennas, transmitters, receivers and computer software; tire pressure and temperature monitoring and measuring machines and instruments, namely, tire pressure gauges; electronic machines and apparatus for measuring, monitoring and transmitting tire pressure and temperature, namely, pressure sensors, temperature sensors, transmitters and receivers; telecommunication machines and apparatus, namely, computer network routers, multiplexers, computer hardware for telecommunications, computer hardware and recorded software for setting up and configuring wide area networks, telecommunication apparatus for measuring, monitoring, and transmitting tire pressure and tire temperature, namely, radio transmitters and receivers, satellite transmitters, GPS transmitters, telephone transmitters, video transmitters, audio- and video-receivers, temperature sensors, and tire pressure sensors; electronic machines, apparatus and their parts, namely, electronic measurement machines and instruments for measuring, monitoring, and transmitting tire pressure and tire temperature, namely, electronic apparatus comprising temperature sensors, tire pressure sensors, radio antennas, radio transmitters and receivers, and computer software for monitoring tire pressure and tire temperature; electronic machines and apparatus for technological and scientific use comprising tire pressure sensors, tire temperature sensors, tire abrasion sensors, vehicle speed sensors, and road surface condition sensors, radio and satellite antennas, GPS antennas, wireless radio transmitters and receivers, and computer software for monitoring tire pressure; computer software for monitoring vehicle drive information, vehicle kinetic information and tire pressure information; terminal devices, namely, computer terminals for collecting and storing information and data measured and saved by on-demand remote monitors and transmitters; computer software for monitoring and managing pressure in tires; tire pressure management and monitoring systems comprising sensors, operating software, and computer hardware; tire pressure sensors; downloadable computer software and mobile applications for use in monitoring, tracking, and reporting tire pressure and temperature; tire pressure management and monitoring systems comprising sensors, operating software, and computer hardware; tire pressure management and monitoring systems primarily comprising sensors, operating software, and computer hardware for measuring and transmitting tire deflection and pressure data; tire pressure or temperature monitoring systems primarily comprising software for monitoring tire pressure and temperature, low tire pressure automatic indicators, tire pressure gauges, electric sensors, tire pressure sensors or temperature sensors, signal transmitters, signal receivers, and electronic display interfaces; sensors for detecting deterioration of road surface; sensors for detecting deterioration of bridge joints; electronic machines and apparatus for use in detecting, monitoring and transmitting deterioration of road surface, namely, computer hardware, computer software, sensors for measuring road surface, transmitters and receivers; electronic machines and apparatus for use in detecting, monitoring and transmitting deterioration of bridge joints namely, computer hardware, computer software, sensors for measuring bridge joint deterioration, transmitters and receivers; computer software for detecting, measuring and monitoring deterioration of road surface in the fields of route planning and optimization, navigation, and optimization of vehicle fleet organization and operation; computer software for detecting, measuring and monitoring deterioration of bridge joints in the fields of route planning and optimization, navigation, and optimization of vehicle fleet organization and operation

**Services****Class 35**

(1) Computerized inventory management featuring tracking of tires to others; subscription management services in relation to hire, leasing, rental, replacement, repair, inspection, maintenance, monitoring, management and hire purchase of tires and vehicle parts; information, advice and consultancy provided in relation to subscription management services in the field of hire, leasing, rental, replacement, repair, inspection, maintenance, monitoring, management and hire purchase of tires and vehicle parts; computerized on-line ordering services in the field of tires that allows consumers to track, locate and monitor tires; computerized database management in relation to tracking, locating and monitoring vehicles; computerized database management in relation to tracking, locating and monitoring tires; business management services, namely managing fleet of commercial motor vehicles, vehicle performance, and workforce; business consulting services relating to operations management services, logistics, transportation and distribution solutions, vehicle maintenance, and optimised driving costs.

### **Class 37**

(2) Installation, maintenance and repair of telematics and navigation apparatus for vehicles, namely, wireless Internet-enabled devices in the nature of on-board computers, GPS receivers and GPS transmitters that provide telematics services and have cellular phone function and transmit vehicle data, messages and information, namely, information about vehicle maintenance and tire pressure and tire temperature, and information, advice and consultancy provided in relation to all the aforesaid services; installation, maintenance and repair of apparatus for locating vehicles, anti-theft equipment for vehicles, electronic navigation and tracking apparatus for use in vehicles, and information, advice and consultancy provided in relation to all the aforesaid services; inspection of tires and vehicles prior to maintenance and repair, and information, advice and consultancy provided in relation to all the aforesaid services; providing information on tire pressure and tire temperature for maintenance of vehicle tires via telecommunication networks; providing information about tire maintenance, tire retreading, and usage of tires to consumers, tire dealers, service providers and fleet managers; tire retreading, namely, retreading tires, and providing advice, repair and maintenance information in the field of retreading tires; consultancy, information and inspection services relating to repair and maintenance of tires and vehicles; consultancy, information and inspection services relating to retread of tires; consultancy, information, advice and inspection services relating to tire maintenance to prevent tire deflection, to safe maintenance and repair of vehicles; inspection of tires and vehicles prior to maintenance and repair or retreading of tires; maintenance, installation and replacement services provided in relation to tires and vehicle parts; repair, inspection prior to potential maintenance and repair, installation, replacement, maintenance of aircraft, namely, tires for aircraft and wheels for aircraft, and information, advice and consultancy services relating to the aforesaid services.

### **Class 38**

(3) Telecommunications services, namely, providing electronic transmission of vehicle and tire data via a global computer network; providing electronic transmission of digital vehicle and tire data, namely, data relating to transmissions for motor vehicles, electrical anti-theft installations for vehicles, navigation apparatus for vehicles in the form of on-board computers, and telematic in-vehicle communication devices, namely, transmitters and receivers for providing wireless vehicle navigation and tracking; providing multiple use access to global computer information networks for the transfer and dissemination of a wide range of information; telecommunications services, namely, providing multiple user access to information relating to traffic, transport and roadworks via a global computer network; broadcasting services relating to traffic, transport and roadworks, namely, broadcasting of information relating to traffic, transport and roadworks via the Internet, and satellite broadcasting of information relating to traffic, transport and roadworks; wireless digital

messaging services, namely, electronic mail services via in-vehicle driver terminals; telecommunications services, namely, providing access to a global computer network for the purpose of loading and automatically updating maps, firmware and software over the air; providing temporary access to non-downloadable software providing map images and geographical and itinerary information obtained with the aid of a global positioning system [GPS] to enable others to determine locations or directions accurately; secure and non-secure telecommunications services, namely, providing electronic transmission of digital data relating to navigation apparatus for vehicles in the form of on-board computers, route planners, and electronic maps via a global computer network

### **Class 39**

(4) Transport, namely, transport of goods and passengers by air, rail, ship, bus, tram and truck, and information, advice and consultancy provided in relation to all the aforesaid services; tracking and tracing of vehicles in transit, and information, advice and consultancy provided in relation to all the aforesaid services; providing of navigation and information services, namely information relating to traffic, road conditions and traffic jams, and information, advice and consultancy provided in relation to all the aforesaid services; provision of information relating to travel, and information, advice and consultancy provided in relation to all the aforesaid services; consultancy relating to traffic, journeys and roadworks, namely monitoring traffic and receiving alerts from vehicles, and information, advice and consultancy provided in relation to all the aforesaid services; logistics and fleet management namely tracking, locating and monitoring vehicles, and information, advice and consultancy provided in relation to all the aforesaid services; rental of tires, and information, advice and consultancy provided in relation to all the aforesaid services; advisory services relating to the storage of tires.

### **Class 42**

(5) Consultancy in the field of computer software design; development and design of navigation systems and route planners; computer software and hardware design; development and design of computer software for use with navigation systems and route planners and with electronic maps and digital dictionaries; design and development of wireless computer networks; software as a service [SaaS] featuring software for tracking and monitoring in the field of fleet management; design of software for compiling and recovering information on the location of vehicles, route reconstruction, driver activities; preparation, update, installation and maintenance of computer software; design and development of databases on traffic and information relating to travel; design and testing of new products for others; design, maintenance and development of computer software for use in relation to the replacement, repair, inspection, installation, monitoring, management, maintenance, leasing, ordering, purchase or hire purchase of tires, vehicle parts, vehicles and groups of vehicles; quality control services, namely monitoring, checking and testing status of tires, vehicle parts, vehicles and groups of vehicles; technical analysis and technological consulting services related to the selection, condition, maintenance, retreading or replacement of vehicle tires; technical analysis and technological consulting services related to the selection, condition, maintenance or replacement of vehicle component parts, spare parts and accessories; providing an online platform for managing information and data associated with tires, vehicle parts, vehicles and groups of vehicles; provision of technical reports and scientific information in relation to tires, vehicle parts, vehicles and groups of vehicles; provision of technical notifications and technical reports concerning tires, vehicle parts, vehicles and groups of vehicles; technical support and consultancy in the form of monitoring global computer network systems; secure or non-secure storage services of digital data, namely the electronic storage of digital data, photographs, audio files, data, information and image signals, all in particular for navigation systems, route planners and the use of electronic maps; inspection services provided in relation to tires and vehicle parts;

technical data analysis of vehicles and vehicle components, namely, tires, brakes, batteries, engine oils and default signals; technical data analysis of bicycles and bicycle components, namely, tires, brakes, batteries and default signals; analysis of research data and statistics relating to vehicles and vehicle components, namely, tires, brakes, batteries, engine oils and default signals; analysis of research data and statistics relating to bicycles and bicycle components, namely, tires, brakes, batteries and default signals; providing technological information, consultancy and advice in relation to vehicles and vehicle components, namely, tires, brakes, batteries, engine oils and default signals; providing technological information, consultancy and advice in relation to bicycles and bicycle components, namely, tires, brakes, batteries and default signals; providing technological information, consultancy and advice in relation to course of action to solve problem of vehicles and vehicle components, namely, tires, brakes, batteries, engine oils and default signals; providing technological information, consultancy and advice in relation to course of action to solve problem of bicycles and bicycle components, namely, tires, brakes, batteries and default signals; providing technological information, consultancy and advice in relation to deterioration of road surface, bridge joints.

(6) Inspection services provided in relation to vehicle parts

### **Claims**

Priority Filing Date: December 09, 2019, Country or Office: JAPAN, Application No: 2019-154263 in association with the same kind of goods and in association with the same kind of services (1), (2), (3), (4), (5); December 18, 2019, Country or Office: JAPAN, Application No: 2019-160154 in association with the same kind of services (6)

**Application Number** 2,038,570  
**International Registration Number** 1540166  
**Language of Application** English

**Filing Date** 2019-12-19

## APPLICANT AND AGENT DETAILS

### Applicant

BRIDGESTONE CORPORATION  
1-1, Kyobashi 3-chome,  
Chuo-ku  
Tokyo 104-8340  
JAPAN

### Agent

DEETH WILLIAMS WALL LLP  
150 YORK STREET, SUITE 400, TORONTO,  
ONTARIO, M5H3S5

## TRADEMARK DETAILS

### Trademark Type

Design

### Visual Representation



### Colour Claim

Colour is claimed as a feature of the trademark. Red, black. The color(s) red and black is/are claimed as a feature of the mark; the mark consists of a stylized letter "B" in red and black; the color white appears as background and is not part of the mark.

### Goods

Class 09

Computer software for monitoring, analyzing flight data and predicting treadwear of tires; checking (supervision) apparatus and instruments, namely, tire depth gauges, tools to detect cracks on products by means of camera, tools to detect cracks on products by means of light, and tools to detect cracks on products by means of air; holders for hand-held computers; measuring apparatus and instruments, namely, pressure gauges, pressure sensors, lasers for measuring purposes, measuring and testing machines and instruments, namely, sensors and gauges for measuring and testing the temperature and pressure of oil, water, automotive fluids, and air in engines, motors, drive trains, transmissions, and tires; satellite and radio transmitter and receiver apparatus, namely, satellite transmitters and receivers, radio transmitters and receivers; signaling apparatus and instruments, namely, flashing safety lights for vehicles and flashing safety lights for traffic cones; software for operating electronic digital dictionaries; telecommunications installations, networks and apparatus, namely, radio transmitters and receivers, satellite transmitters, GPS transmitters, telephone transmitters, video transmitters, audio- and video-receivers, mobile phones; mounting racks for telecommunications computer hardware; telematics apparatus, namely, wireless Internet-enabled devices in the nature of on-board computers, GPS receivers and GPS transmitters that provide telematics services and have cellular phone function; barcode scanners; two-dimensional code scanners; printers, namely, thermal printers, inkjet printers, laser printers; surveying instruments; computer hardware and software for use with satellite and GPS navigation systems for navigation purposes; computer software for operating satellite navigational systems and global positioning systems [GPS], and for use of global positioning systems [GPS] for tracking, locating and security of vehicles and objects; computer software for use with route planners, electronic maps and digital dictionaries for navigation purposes; computer terminals, all in particular for the use of navigation systems, route planners, and digital maps; downloadable electronic maps; global positioning system (GPS) consisting of computers, computer software, transmitters, receivers, and network interface devices; location, orientation and navigation, and global positioning systems (GPS) consisting of computers, computer software, transmitters, global positioning system receivers and satellite receivers; mobile computing and operating platforms consisting of data transceivers, wireless networks and gateways for collection and management of data; navigation apparatus for vehicles in the nature of on-board computers; route planners in the form of hand-held personal computers (hand-held computers); satellite navigational systems, namely global positioning systems consisting of satellites, computers, computer software, transmitters, receivers, and network interface devices; computer software for database management in the field of transportation and traffic; software for management and maintenance of groups of vehicles, namely, software for tracking and monitoring vehicles, and for scheduling and management of vehicle maintenance, for use in the field of vehicle management; software for operating route planners; software for in-vehicle navigation and entertainment systems for providing and displaying travel advice on petrol stations, car parks, restaurants, hotels, and car dealers; computer software for displaying orders and vehicle locations on maps; software to indicate maintenance requirements and maintenance scheduling for vehicles; vehicle locating, tracking and security systems comprised of an antennas and radio transmitters to be placed in vehicles; downloadable electronic databases containing information relating to tires, vehicle parts, vehicles and groups of vehicles; electronic publications relating to tires, vehicle parts, vehicles and groups of vehicles; electronic reports relating to tires, vehicle parts, vehicles and groups of vehicles; electronic sensing, checking, monitoring and communication devices used in relation to vehicles, tires, vehicle parts and groups of vehicles, namely, telecommunication devices comprised of receivers, transmitters and computer hardware and software for collecting, tracking, storing, managing, reporting, and transmitting tire and vehicle telematics data; electronic sensors for tires, vehicles and vehicle parts, namely, temperature sensors, pressure sensors, acceleration sensors, distance sensors, velocity sensors, tire abrasion sensors, and road surface condition



sensors; downloadable software for arranging and managing subscription services relating to monitoring, maintenance, replacement and purchase of tires and vehicle parts; downloadable software for arranging the replacement, repair, inspection, installation, monitoring, management, maintenance, ordering and purchase of tires, vehicle parts and vehicles; software used in relation to tires, vehicle parts, vehicles and groups of vehicles, namely, computer software for collecting, tracking, storing, managing, reporting, and transmitting tire and vehicle telematics data; downloadable computer software and mobile applications for use in monitoring and tracking tires and tire data, namely, tire deflection data, tire pressure data, tire abrasion data, vehicle speed data, and road surface condition data; computer software for vehicle fleet management; computer software for use in managing, tracking, and optimizing fleet operation costs and productivity based on commercial fleet tire data; computer software for use in monitoring tracking and reporting tire treadwear data, and predicting potential risky driving conditions for tires and allow vehicles to react to such conditions to prevent accident; downloadable computer software and mobile applications for analyzing treadwear of tires based on pictures; accident preventing systems primarily comprising sensors, operating software and computer hardware for measuring and transmitting tire treadwear data; tire treadwear detecting systems primarily comprising treadwear detecting sensors, low tire pressure automatic indicators, electric sensors, signal transmitters, signal receivers, and electronic display interfaces; computer software for reporting the performance and condition of tires in retreading tires; computer software for tire retread dealers to track, photograph, and provide receipts for retreaded tires; computer software for tracking inventory of retread tires; computer software for information tracking and reporting functions in the retread tire business in the field of customer relationship management, supply chain management, human services, and financial applications, all designed to help businesses in the retread, commercial, retail and wholesale tire industry; tire pressure monitoring systems comprising a computer, pressure sensors, antennas, transmitters, receivers and computer software; tire pressure and temperature monitoring and measuring machines and instruments, namely, tire pressure gauges; electronic machines and apparatus for measuring, monitoring and transmitting tire pressure and temperature, namely, pressure sensors, temperature sensors, transmitters and receivers; telecommunication machines and apparatus, namely, computer network routers, multiplexers, computer hardware for telecommunications, computer hardware and recorded software for setting up and configuring wide area networks, telecommunication apparatus for measuring, monitoring, and transmitting tire pressure and tire temperature, namely, radio transmitters and receivers, satellite transmitters, GPS transmitters, telephone transmitters, video transmitters, audio- and video-receivers, temperature sensors, and tire pressure sensors; electronic machines, apparatus and their parts, namely, electronic measurement machines and instruments for measuring, monitoring, and transmitting tire pressure and tire temperature, namely, electronic apparatus comprising temperature sensors, tire pressure sensors, radio antennas, radio transmitters and receivers, and computer software for monitoring tire pressure and tire temperature; electronic machines and apparatus for technological and scientific use comprising tire pressure sensors, tire temperature sensors, tire abrasion sensors, vehicle speed sensors, and road surface condition sensors, radio and satellite antennas, GPS antennas, wireless radio transmitters and receivers, and computer software for monitoring tire pressure; computer software for monitoring vehicle drive information, vehicle kinetic information and tire pressure information; terminal devices, namely, computer terminals for collecting and storing information and data measured and saved by on-demand remote monitors and transmitters; computer software for monitoring and managing pressure in tires; tire pressure management and monitoring systems comprising sensors, operating software, and computer hardware; tire pressure sensors; downloadable computer software and mobile applications for use in monitoring, tracking, and reporting tire pressure and temperature; tire pressure management and monitoring systems comprising sensors, operating software, and computer hardware; tire

pressure management and monitoring systems primarily comprising sensors, operating software, and computer hardware for measuring and transmitting tire deflection and pressure data; tire pressure or temperature monitoring systems primarily comprising software for monitoring tire pressure and temperature, low tire pressure automatic indicators, tire pressure gauges, electric sensors, tire pressure sensors or temperature sensors, signal transmitters, signal receivers, and electronic display interfaces; sensors for detecting deterioration of road surface; sensors for detecting deterioration of bridge joints; electronic machines and apparatus for use in detecting, monitoring and transmitting deterioration of road surface, namely, computer hardware, computer software, sensors for measuring road surface, transmitters and receivers; electronic machines and apparatus for use in detecting, monitoring and transmitting deterioration of bridge joints namely, computer hardware, computer software, sensors for measuring bridge joint deterioration, transmitters and receivers; computer software for detecting, measuring and monitoring deterioration of road surface in the fields of route planning and optimization, navigation, and optimization of vehicle fleet organization and operation; computer software for detecting, measuring and monitoring deterioration of bridge joints in the fields of route planning and optimization, navigation, and optimization of vehicle fleet organization and operation

## **Services**

### **Class 35**

(1) Computerized inventory management featuring tracking of tires to others; subscription management services in relation to hire, leasing, rental, replacement, repair, inspection, maintenance, monitoring, management and hire purchase of tires and vehicle parts; information, advice and consultancy provided in relation to subscription management services in the field of hire, leasing, rental, replacement, repair, inspection, maintenance, monitoring, management and hire purchase of tires and vehicle parts; computerized on-line ordering services in the field of tires that allows consumers to track, locate and monitor tires; computerized database management in relation to tracking, locating and monitoring vehicles; computerized database management in relation to tracking, locating and monitoring tires; business management services, namely managing fleet of commercial motor vehicles, vehicle performance, and workforce; business consulting services relating to operations management services, logistics, transportation and distribution solutions, vehicle maintenance, and optimised driving costs.

### **Class 37**

(2) Installation, maintenance and repair of telematics and navigation apparatus for vehicles, namely, wireless Internet-enabled devices in the nature of on-board computers, GPS receivers and GPS transmitters that provide telematics services and have cellular phone function and transmit vehicle data, messages and information, namely, information about vehicle maintenance and tire pressure and tire temperature, and information, advice and consultancy provided in relation to all the aforesaid services; installation, maintenance and repair of apparatus for locating vehicles, anti-theft equipment for vehicles, electronic navigation and tracking apparatus for use in vehicles, and information, advice and consultancy provided in relation to all the aforesaid services; inspection of tires and vehicles prior to maintenance and repair, and information, advice and consultancy provided in relation to all the aforesaid services; providing information on tire pressure and tire temperature for maintenance of vehicle tires via telecommunication networks; providing information about tire maintenance, tire retreading, and usage of tires to consumers, tire dealers, service providers and fleet managers; tire retreading, namely, retreading tires, and providing advice, repair and maintenance information in the field of retreading tires; consultancy, information and inspection services relating to repair and maintenance of tires and vehicles; consultancy, information and inspection services relating to retread of tires; consultancy, information, advice

and inspection services relating to tire maintenance to prevent tire deflection, to safe maintenance and repair of vehicles; inspection of tires and vehicles prior to maintenance and repair or retreading of tires; maintenance, installation and replacement services provided in relation to tires and vehicle parts; repair, inspection prior to potential maintenance and repair, installation, replacement, maintenance of aircraft, namely, tires for aircraft and wheels for aircraft, and information, advice and consultancy services relating to the aforesaid services.

### **Class 38**

(3) Telecommunications services, namely, providing electronic transmission of vehicle and tire data via a global computer network; providing electronic transmission of digital vehicle and tire data, namely, data relating to transmissions for motor vehicles, electrical anti-theft installations for vehicles, navigation apparatus for vehicles in the form of on-board computers, and telematic in-vehicle communication devices, namely, transmitters and receivers for providing wireless vehicle navigation and tracking; providing multiple use access to global computer information networks for the transfer and dissemination of a wide range of information; telecommunications services, namely, providing multiple user access to information relating to traffic, transport and roadworks via a global computer network; broadcasting services relating to traffic, transport and roadworks, namely, broadcasting of information relating to traffic, transport and roadworks via the Internet, and satellite broadcasting of information relating to traffic, transport and roadworks; wireless digital messaging services, namely, electronic mail services via in-vehicle driver terminals; telecommunications services, namely, providing access to a global computer network for the purpose of loading and automatically updating maps, firmware and software over the air; providing temporary access to non-downloadable software providing map images and geographical and itinerary information obtained with the aid of a global positioning system [GPS] to enable others to determine locations or directions accurately; secure and non-secure telecommunications services, namely, providing electronic transmission of digital data relating to navigation apparatus for vehicles in the form of on-board computers, route planners, and electronic maps via a global computer network

### **Class 39**

(4) Transport, namely, transport of goods and passengers by air, rail, ship, bus, tram and truck, and information, advice and consultancy provided in relation to all the aforesaid services; tracking and tracing of vehicles in transit, and information, advice and consultancy provided in relation to all the aforesaid services; providing of navigation and information services, namely information relating to traffic, road conditions and traffic jams, and information, advice and consultancy provided in relation to all the aforesaid services; provision of information relating to travel, and information, advice and consultancy provided in relation to all the aforesaid services; consultancy relating to traffic, journeys and roadworks, namely monitoring traffic and receiving alerts from vehicles, and information, advice and consultancy provided in relation to all the aforesaid services; logistics and fleet management namely tracking, locating and monitoring vehicles, and information, advice and consultancy provided in relation to all the aforesaid services; rental of tires, and information, advice and consultancy provided in relation to all the aforesaid services; advisory services relating to the storage of tires.

### **Class 42**

(5) Consultancy in the field of computer software design; development and design of navigation systems and route planners; computer software and hardware design; development and design of computer software for use with navigation systems and route planners and with electronic maps and digital dictionaries; design and development of wireless computer networks; software as a service [SaaS] featuring software for tracking and monitoring in the field of fleet management;

design of software for compiling and recovering information on the location of vehicles, route reconstruction, driver activities; preparation, update, installation and maintenance of computer software; design and development of databases on traffic and information relating to travel; design and testing of new products for others; design, maintenance and development of computer software for use in relation to the replacement, repair, inspection, installation, monitoring, management, maintenance, leasing, ordering, purchase or hire purchase of tires, vehicle parts, vehicles and groups of vehicles; quality control services, namely monitoring, checking and testing status of tires, vehicle parts, vehicles and groups of vehicles; technical analysis and technological consulting services related to the selection, condition, maintenance, retreading or replacement of vehicle tires; technical analysis and technological consulting services related to the selection, condition, maintenance or replacement of vehicle component parts, spare parts and accessories; providing an online platform for managing information and data associated with tires, vehicle parts, vehicles and groups of vehicles; provision of technical reports and scientific information in relation to tires, vehicle parts, vehicles and groups of vehicles; provision of technical notifications and technical reports concerning tires, vehicle parts, vehicles and groups of vehicles; technical support and consultancy in the form of monitoring global computer network systems; secure or non-secure storage services of digital data, namely the electronic storage of digital data, photographs, audio files, data, information and image signals, all in particular for navigation systems, route planners and the use of electronic maps; inspection services provided in relation to tires; technical data analysis of vehicles and vehicle components, namely, tires, brakes, batteries, engine oils and default signals; technical data analysis of bicycles and bicycle components, namely, tires, brakes, batteries and default signals; analysis of research data and statistics relating to vehicles and vehicle components, namely, tires, brakes, batteries, engine oils and default signals; analysis of research data and statistics relating to bicycles and bicycle components, namely, tires, brakes, batteries and default signals; providing technological information, consultancy and advice in relation to vehicles and vehicle components, namely, tires, brakes, batteries, engine oils and default signals; providing technological information, consultancy and advice in relation to bicycles and bicycle components, namely, tires, brakes, batteries and default signals; providing technological information, consultancy and advice in relation to course of action to solve problem of vehicles and vehicle components, namely, tires, brakes, batteries, engine oils and default signals; providing technological information, consultancy and advice in relation to course of action to solve problem of bicycles and bicycle components, namely, tires, brakes, batteries and default signals; providing technological information, consultancy and advice in relation to deterioration of road surface, bridge joints.

(6) Inspection services provided in relation to vehicle parts

### **Claims**

Priority Filing Date: December 09, 2019, Country or Office: JAPAN, Application No: 2019-154264 in association with the same kind of goods and in association with the same kind of services (1), (2), (3), (4), (5); December 18, 2019, Country or Office: JAPAN, Application No: 2019-160155 in association with the same kind of services (6)

**Application Number** 2,038,796  
**International Registration Number** 0943391  
**Language of Application** English

**Filing Date** 2020-06-08

## APPLICANT AND AGENT DETAILS

### Applicant

TECO S.R.L.  
Via Sandro Pertini, 39/41  
PROVAGLIO D'ISEO  
Località NOCCOLE (Brescia)  
ITALY

### Agent

ROBIC  
630, boul. René-Lévesque Ouest, 20e étage,  
Montréal, QUEBEC, H3B1S6

## TRADEMARK DETAILS

### Trademark Type

Design

### Visual Representation



### Trademark Description

The mark consists of a sign depicting the wording TECO in fancy characters preceded by a circle, a circular section being detached from its upper part.

### Foreign Character Translation

With you.

### Goods

#### Class 06

(1) Water-pipe valves of metal; metal drain traps, being valves; valves of metal, other than parts of machines, namely metal valves for controlling the flow of gases in pipelines, metal valves for water pipes; excess flow valves, manifolds of metal for pipelines, ALL THE ABOVE MENTIONED GOODS EXCLUDING FABRICATED METAL JOINTS FOR TIMBER CONNECTIONS.

#### Class 11

(2) Regulating accessories for water and gas apparatus and pipes, namely pressure regulators, metered valves, dosing valves excess flow valves; Regulating accessories for water supply and sanitary purposes, namely pressure regulators, metered valves, dosing valves and metal valves

for controlling the flow of water, excess flow valves; regulating and safety accessories, namely excess flow valves, pressure regulators, metered valves, dosing valves, metal valves for controlling the flow of gases, flashback arrestors and reverse flow check valves for gas apparatus, namely power generators, stoves, ranges, compressors, refrigerators, heating installations and water heaters; regulating and safety accessories, namely excess flow valves, pressure regulators, metered valves, dosing valves, metal valves for controlling the flow of gases, flashback arrestors and reverse flow check valves for gas pipes; safety accessories for water and gas apparatus and pipes, namely, excess flow valves, pressure regulators, metered valves, dosing valves, metal valves for controlling the flow of gases and water, flashback arrestors and reverse flow check valves; thermally activated regulating and safety devices, namely fire safety activated shut-off safety valve comprised of external steel body and thermostat to block excess flow of gas for gas apparatus; thermally activated regulating and safety devices, namely fire safety activated shut-off safety valve comprised of external steel body and thermostat to block excess flow of gas in gas pipes; thermally activated safety devices, namely fire safety activated shut-off safety valve comprised of external steel body and thermostat to block excess flow of gas and water for water and gas apparatus, namely power generators, stoves, ranges, compressors, refrigerators, heating installations, water heaters, water filtering units and purifiers for household and industrial purposes and water and gas pipes, ALL THE ABOVE MENTIONED GOODS EXCLUDING FABRICATED METAL JOINTS FOR TIMBER CONNECTIONS.

**Application Number** 2,038,851  
**International Registration Number** 1067226  
**Language of Application** English

**Filing Date** 2020-06-18

## APPLICANT AND AGENT DETAILS

### Applicant

ESCOFET INTERNACIONAL, S.L.  
Rda. General Mitre, 160, 1<sup>a</sup>  
E-08006 Barcelona  
SPAIN

### Agent

NEXUS LAW GROUP LLP  
777 Hornby Street, Suite 2000, Vancouver,  
BRITISH COLUMBIA, V6Z1S4

## TRADEMARK DETAILS

### Trademark Type

Design

### Visual Representation

The logo for 'Escofet' is rendered in a very bold, black, stylized font. The letters are thick and blocky, with a slightly irregular, hand-drawn appearance. The 'E' is particularly large and features a small dot on its left side. The overall style is reminiscent of a heavy, industrial or construction-related typeface.

### Goods

#### Class 19

Building materials, not of metal, namely, concrete, glass panels for building purposes, insulating glass for building, multilayer panels of plastic for use in building; asphalt paving; cement paving tiles; ceramic tiles; cobbles; rigid pipes for building, not of metal, namely, rigid pipes made of plastic for construction purposes; non-metallic rigid pipes for building, namely, concrete pipes, PVC rigid pipes for construction purposes; buildings, transportable, not of metal, namely, transportable air domes and sheds; monuments, not of metal, namely, sculptures made of marble, cement and stone, stucco tile, and non-metal trellises.

**Application Number** 2,039,166  
**Language of Application** French

**Filing Date** 2020-07-10

## APPLICANT AND AGENT DETAILS

### Applicant

SONAFI, Société par Actions Simplifiée  
42, rue Rieussec  
78220 Viroflay,  
FRANCE

### Agent

ROBIC  
630, boul. René-Lévesque Ouest, 20e étage,  
Montréal, QUÉBEC, H3B1S6

## TRADEMARK DETAILS

# ADAMANCE

### Trademark Type

Standard Characters

### Goods

#### Class 29

(1) Milk beverages flavoured with tea; milk beverages containing fruit; milk-based, strawberry-flavoured beverages; milk-based, vanilla-flavoured beverages; milk-based beverages containing fruit; fruit-based snacks; compotes; jams; sliced fruits, canned; fruit-based desserts; fruit-based snack food; fruits in syrup; stewed fruits; fruits preserved in alcohol; crystallized fruits; stewed fruits; bottled fruits; appertized fruits and vegetables; vacuum-packed fruits and vegetables; preserved, frozen and dried fruits and vegetables; frosted fruits; freeze-dried fruits; pressed fruit paste; flavoured nuts; seasoned nuts; candied nuts; spiced mixed nuts; nuts sprinkled with sugar; fruit fillings; edible jellies; fruit jellies; vegetable jellies; jellies for food, other than confectionery; vegetable-based puff snack foods; vegetable-based snack foods; cut vegetables; bottled vegetables; grilled vegetables; freeze-dried vegetables; pickled vegetables; pre-cut vegetables for salads; vegetable soufflés; mixed vegetables; marmalades; fruit mousses; vegetable mousses; snack mix consisting primarily of processed fruits; vegetable side dishes; prepared meals consisting primarily of spinach; prepared meals consisting primarily of cooked vegetables; prepared and packaged meals consisting primarily of cooked fruits and vegetables; fruit pulp; fruit purées; fruit and vegetable salads; vegetable-based snack foods; fruit peel.

#### Class 30

(2) Chocolate flavourings; fruit flavourings; chocolate candies; fruit jelly candy; chocolate chips; cocoa; cocoa powder; brownies; fruit jelly squares; couverture chocolate; baking chocolate; chocolate powder; bittersweet chocolate; semisweet chocolate; unsweetened chocolate; chocolate for confectioneries; baking chocolate; chocolate confectionery containing pralines; frozen confectionery; nut-based confectionery; chocolate confectionery; almond confectionery; peanut confectionery; frozen confectionery; sweet confectionery; fruit-based confectionery; fruit coulis; confectionery fondants; confectionery fruit jellies; fruit frosting for cakes; chocolate topping; aromatic preparations for candies; aromatic preparations for ice-creams; cocoa-based preparations for making beverages; fruit paste being confectionery; fruit paste for flavouring food; chocolate spreads; confectionery fruit pastes; pastries; molasses syrup; chocolate bars.

#### Class 32



(3) Fruit-flavoured beverages; fruit beverages; fruit and vegetable beverages; vegetable beverages; smoothies; soft drinks; non-alcoholic beverages made from almonds, other than milk substitutes; non-alcoholic beverages made from oats, other than milk substitutes; non-alcoholic beverages made from hazelnuts, other than milk substitutes; fruit-based alcohol-free beverages flavoured with tea; alcohol-free beverages made with fruit juices; alcohol-free beverages made with aloe vera; fruit-based beverages; fruit beverages and fruit juices; beverages made of Flavored ice; vegetable-based beverages; nut based beverages; coconut-based beverages; rice-based beverages, other than milk substitutes; soy-based beverages, other than milk substitutes; aloe vera drinks; energy drinks; alcohol-free fruit cocktails; coconut water; herb-based soda water; flavoured waters; essences for making non-alcoholic beverages; alcohol-free fruit extracts; alcohol-free fruit extracts for the preparation of beverages; wheatgrass juice; herbal juices; fruit juices; vegetable juices; tomato juice; vegetable juices; fruit nectars; powders for the preparation of alcohol-free beverages; alcohol-free cocktail mixes; fruit juice bases; syrups for beverages; syrups for making fruit-flavoured beverages; smoothies.

**Claims**

Priority Filing Date: March 25, 2020, Country or Office: FRANCE, Application No: 204634673 in association with the same kind of goods

**Application Number** 2,040,338  
**Language of Application** English

**Filing Date** 2020-07-16

## APPLICANT AND AGENT DETAILS

### Applicant

BAYER INTELLECTUAL PROPERTY GMBH  
Alfred-Nobel Straße 10  
40789  
Monheim am Rhein  
GERMANY

### Agent

GOWLING WLG (CANADA) LLP  
SUITE 2600, 160 ELGIN STREET, OTTAWA,  
ONTARIO, K1P1C3

## TRADEMARK DETAILS

# CANESCOMFORT

### Trademark Type

Standard Characters

### Goods

#### Class 05

(1) Antibiotic preparations; Vaginal antifungal preparations; Vaginal suppositories for the prevention and treatment of infections; Preparations for the treatment of bacterial vaginosis infections;

#### Class 10

(2) Vaginal syringes; Vaginal tube applicators for administering antibiotic preparations, vaginal antifungal preparations, vaginal suppositories for the prevention and treatment of infections, and preparations for the treatment of bacterial vaginosis infections;

**Application Number** 2,040,343  
**Language of Application** English

**Filing Date** 2020-07-16

## APPLICANT AND AGENT DETAILS

### Applicant

Dwayne R. Lasas  
1528 Argyle Avenue  
Saskatoon  
SASKATCHEWAN  
S7H2W5

### Agent

MLT AIKINS LLP  
2100 Livingston Place, 222-3rd Avenue SW,  
Calgary, ALBERTA, T2P0B4

## TRADEMARK DETAILS

# WEETSEETOWIN

### Trademark Type

Standard Characters

### Foreign Character Translation

The translation provided by the applicant of the Cree word(s) WEETSEETOWIN is "to assist, support and stand with a person or persons".

### Goods

#### Class 28

Card game.

**Application Number** 2,040,418  
**Language of Application** English

**Filing Date** 2020-07-17

## APPLICANT AND AGENT DETAILS

### Applicant

MAAX SPAS INDUSTRIES CORP.  
25605 South Arizona Avenue  
Chandler, AZ 85248  
UNITED STATES OF AMERICA

### Agent

GOWLING WLG (CANADA) LLP  
1 PLACE VILLE MARIE, 37TH FLOOR/37E  
ETAGE, MONTREAL, QUEBEC, H3B3P4

## TRADEMARK DETAILS

# VITA SPA

### Trademark Type

Standard Characters

### Goods

#### Class 11

Hot tubs; swim spas; whirlpool baths; heaters for hot tubs; pumps, bath fittings, filters, lighting fixtures, and heaters sold in combination for use in hot tubs or swim spas; bath fittings for use in hot tubs or swim spas; plumbing fittings for use in hot tubs or swim spas; lighting fixtures for use in hot tubs or swim spas.

**Application Number** 2,040,864  
**Language of Application** English

**Filing Date** 2020-07-21

## APPLICANT DETAILS

### Applicant

Chengwei Zhang  
No. 32 Guyu St., Shanhou Vil., Nancheng St.,  
Huangyan Dist.  
Taizhou, Zhejiang, 318000  
CHINA

## TRADEMARK DETAILS

# Kijeel

### Trademark Type

Standard Characters

### Goods

#### Class 28

abdominal benches for exercise; abdominal boards for exercise; board games; body protectors for athletic use; bowling balls; carnival masks; Christmas ornaments; elliptical exercise machines; exercise balls; exercise platforms; exercise treadmills; fishing tackle; free weights for physical exercise; gaming machines; gaming tables; gyroscopes and flight stabilizers for model aircraft; hand-held joystick units for playing video games; hand-held units for playing video games; in-line roller skates; pet toys; plush toys; radio-controlled toys; ride-on toys; sports balls; stair-climbing machines for exercise; stair-stepping machines for exercise; toys for infants

**Application Number** 2,040,871  
**Language of Application** English

**Filing Date** 2020-07-21

## APPLICANT DETAILS

### Applicant

Wenhua Zhang  
No.476 Shuangpu Vil., Dongcheng St.,  
Huangyan Dist.  
Taizhou, Zhejiang, 318000  
CHINA

## TRADEMARK DETAILS

# Gleyi

### Trademark Type

Standard Characters

### Goods

#### Class 18

all purpose sport bags; backpacks; briefcases; canes; clothing for pets; collars for pets; frames for umbrellas or parasols; handbag frames; leather; leather for furniture; leather leads; leather pouches for merchandise packaging; leather straps; luggage trunks; pocket wallets; pouch baby carriers; purses; shopping bags; slings for carrying infants; unwrought and semi-wrought leather; vanity cases

**Application Number** 2,042,673  
**International Registration Number** 1542954  
**Language of Application** English

**Filing Date** 2020-04-01

## APPLICANT AND AGENT DETAILS

### Applicant

REA Innovations, Inc.  
7950 NE Day Road West, Suite B  
Bainbridge Island WA 98110  
UNITED STATES OF AMERICA

### Agent

GOWLING WLG (CANADA) LLP  
550 BURRARD STREET, SUITE 2300,  
VANCOUVER, BRITISH COLUMBIA, V6C2B5

## TRADEMARK DETAILS

# OPULUS

### Trademark Type

Standard Characters

### Goods

#### Class 03

(1) Cosmetics.

(2) Non-medicated skin care preparations; non-medicated hair care preparations; non-medicated nail care preparations; moisturizing preparations, namely anti-aging moisturizers, for the body; moisturizing preparations, namely moisturizing creams, lotions, and gels, for the body; anti-aging cosmetic preparations; capsules containing cosmetic preparations, namely anti-aging cosmetic preparations, for the body for topical use; capsules containing cosmetic preparations, namely cosmetic creams, lotions, and gels, for topical use; capsules containing non-medicated skin care preparations for topical use; capsules containing non-medicated hair care preparations for topical use; capsules containing non-medicated nail care preparations for topical use; capsules containing moisturizing preparations, namely anti-aging moisturizers, for the body for topical use; capsules containing moisturizing preparations, namely moisturizing creams, lotions, and gels, for the body for topical use; capsules containing anti-aging cosmetic preparations for topical use.

#### Class 21

(3) Cosmetic utensils for skincare, haircare, and nail care purposes, namely, electrically powered household appliances for blending and heating cosmetics, cosmetic body care preparations, cosmetic hair care preparations, and cosmetic nail care preparations for topical use; cosmetic utensils for household skincare, haircare, and nail care purposes, namely, electrically powered household appliances for blending and heating cosmetics, cosmetic body care preparations, cosmetic hair care preparations, and cosmetic nail care preparations for topical use

### Claims

Priority Filing Date: October 01, 2019, Country or Office: UNITED STATES OF AMERICA, Application No: 88638344 in association with the same kind of goods (1); March 31, 2020, Country or Office: UNITED STATES OF AMERICA, Application No: 88853958 in association with the same kind of goods (2), (3)

**Application Number** 2,042,685  
**International Registration Number** 1542753  
**Language of Application** English

**Filing Date** 2020-04-14

## APPLICANT AND AGENT DETAILS

### Applicant

JARL ENTERPRISES PTY LTD  
1/89a Piper Street  
Kyneton VIC 3444  
AUSTRALIA

### Agent

OSLER, HOSKIN & HARCOURT LLP  
Suite 320, World Exchange Plaza, 100 Queen  
Street, Ottawa, ONTARIO, K1P1J9

## TRADEMARK DETAILS

**Trademark Type**

Design

**Visual Representation**



**ANIMU**  
**— DISTILLERY —**



**Goods****Class 33**

Alcoholic beverages (except beer), namely, alcoholic bitters, alcoholic chocolate-based beverages, alcoholic cocktail mixes, alcoholic cocktails, alcoholic coffee-based beverages, alcoholic coolers, alcoholic cordials, alcoholic fruit beverages, alcoholic punches, alcoholic seltzer, alcoholic tea-based beverages, prepared alcoholic cocktails; alcohol for drinking, namely, brandy, gin, rum, tequila, vodka, whisky; distilled alcoholic beverages, namely, gin-based beverages, vodka-based beverages, vodka cocktails, whisky-based beverages, whisky cocktails; gin; gin and flavored tonic liqueurs; gin cocktails.

**Claims**

Priority Filing Date: October 23, 2019, Country or Office: AUSTRALIA, Application No: 2045752 in association with the same kind of goods

**Application Number** 2,042,715  
**International Registration Number** 1543443  
**Language of Application** English

**Filing Date** 2020-05-07

## APPLICANT AND AGENT DETAILS

### Applicant

Box, Inc.  
900 Jefferson Ave.  
Redwood City CA 94063  
UNITED STATES OF AMERICA

### Agent

GOWLING WLG (CANADA) LLP  
SUITE 2600, 160 ELGIN STREET, OTTAWA,  
ONTARIO, K1P1C3

## TRADEMARK DETAILS

### Trademark Type

Design

### Visual Representation



  
**Trademark Description**

The mark consists of a design of a flag with a chevron pointing to the left.

**Goods****Class 09**

Downloadable software for cloud infrastructure management and automation for collecting storing, securing, analyzing, organizing, editing, receiving, and sharing electronic data.

**Services****Class 42**

Software as a service (SAAS) services for cloud infrastructure management and automation featuring cloud based software for use as an application development framework providing use of a web interface for facilitation, management, streamlining, and use in business process management, task management, workflow tracking, form creation, application development, process reporting, process analysis, schedule management, human resource allocation, workforce collaboration, business process automation, and disparate systems integration; design of workflow platform software; hosting of workflow platform software of others on a computer server for a global computer network; software as a service (SAAS) services, namely, hosting software for use by others for use in business process management, task management, workflow tracking, form creation, application development, process reporting, process analysis, schedule management, human resource allocation, workforce collaboration, business process automation, and disparate systems integration; web portal services, namely, designing and hosting of web portals for others; creating and designing web pages for others, namely, creating virtual communities for registered users to interact and participate in discussions.

**Claims**

Priority Filing Date: November 07, 2019, Country or Office: UNITED STATES OF AMERICA, Application No: 88683935 in association with the same kind of services; January 07, 2020, Country or Office: UNITED STATES OF AMERICA, Application No: 88749872 in association with the same kind of goods

**Application Number** 2,042,718  
**International Registration Number** 1543225  
**Language of Application** English

**Filing Date** 2020-05-09

## APPLICANT AND AGENT DETAILS

### Applicant

MOON VENTURES LIMITED  
Janine Grainger,  
1 Bert Wall Drive  
Omokoroa 3114  
NEW ZEALAND

### Agent

ERIN MCEWEN  
NELLIGAN O'BRIEN PAYNE LLP , 50  
O'Connor Street, Suite 300, Ottawa,  
ONTARIO, K1P6L2

## TRADEMARK DETAILS

### Trademark Type

Design

### Visual Representation



**EASYCRYPT**

### Colour Claim

Colour is claimed as a feature of the trademark. The Background of the mark is white. The two Letters "E" and "C" appearing in the "Hexagon" design consist of dark and light purple. The dark portions of the "Hexagon" design are dark purple. The light portions of the "Hexagon" design are light purple. The word "EASY" is black. The word "CRYPTO" is grey

### Services

#### Class 36

Computerized financial services, namely provision of a cryptocurrency blockchain for digital currency exchange and trading services; financial services provided by electronic means, namely provision of a cryptocurrency blockchain for digital currency exchange and trading services; financial services provided over the internet and by telephone; financial services provided over the internet and telephone, namely provision of a cryptocurrency blockchain for digital currency exchange and trading services; currency transfer services; electronic transfer of a virtual currency for use by members of an on-line community via a global computer network; electronic transfer of a virtual currency for use by members of an online community via a global computer network; virtual currency trading services; on-line brokerage for trading and transactions relating to currency and other financial products; financial exchange of virtual currency

**Application Number** 2,042,828  
**International Registration Number** 1543546  
**Language of Application** English

**Filing Date** 2020-06-09

## APPLICANT AND AGENT DETAILS

### Applicant

JOLTA, LLC  
1200 WEST AVE PH TS1  
Miami Beach FL 33139  
UNITED STATES OF AMERICA

### Agent

PAUL LOMIC  
(Lomic Law), 1 First Canadian Place, 100 King  
Street, Toronto, ONTARIO, M5X1C7

## TRADEMARK DETAILS

# JOLTA

### Trademark Type

Standard Characters

### Services

#### Class 35

(1) Automobile, motorbikes, bicycles, electric trucks, and electric buses dealership; Online website providing automobile, motorbikes, bicycles, electric trucks, and electric buses dealership services; Providing used and new car, motorbikes, bicycles, electric trucks, and electric buses' sales leads for others; Online website providing used and new car, motorbikes, bicycles, electric trucks, and electric buses' sales leads for others; Retail sale of electric vehicle supply equipment spare parts; Online retail sale of electric vehicle supply equipment spare parts

#### Class 37

(2) Maintenance and repair services of electric vehicles; conversion of non-electric vehicles into electric vehicles; Installation services, namely, installation of electric chargers for electric vehicles.

**Application Number** 2,042,939  
**International Registration Number** 1542620  
**Language of Application** English

**Filing Date** 2020-06-24

## APPLICANT AND AGENT DETAILS

### Applicant

KT Health, LLC  
584 East 1100 South, Suite 4  
American Fork UT 84003  
UNITED STATES OF AMERICA

### Agent

DENTONS CANADA LLP  
20TH FLOOR, 250 HOWE STREET,  
VANCOUVER, BRITISH COLUMBIA, V6C3R8

## TRADEMARK DETAILS

# TRAIN LONGER. FINISH STRONGER.

### Trademark Type

Standard Characters

### Goods

#### Class 10

Heating pads for medical purposes; chemically activated hot and cold gel packs for medical purposes; chemically activated hot and cold compresses for medical purposes; therapeutic compression wraps; therapeutic hot and cold compression wraps; therapeutic hot and cold therapy packs.

**Application Number** 2,042,995  
**International Registration Number** 1364541  
**Language of Application** English

**Filing Date** 2020-07-01

## APPLICANT AND AGENT DETAILS

### Applicant

EMILIANA SERBATOI S.R.L.  
Largo Maestri del Lavoro, 40  
I-41011 Campogalliano (MO)  
ITALY

### Agent

MBM INTELLECTUAL PROPERTY AGENCY  
275 SLATER STREET, 14TH FLOOR,  
OTTAWA, ONTARIO, K1P5H9

## TRADEMARK DETAILS

### Trademark Type

Design

### Visual Representation



### Trademark Description

The mark consists of an imprint depicting the wording EMILIANA SERBATOI written in fancy characters in combination with a stylized image of a squared figure containing one curvilinear line linked with two straight lines.

### Goods

#### Class 06

(1) Fluid storage tanks of metal; water tanks of metal for household purposes; metal storage tanks and roofs therefor; water tanks of metal; casks of metal; containers of metal for transport; containers of metal for storage; industrial water tanks of metal; gas storage tanks of metal.

#### Class 11

(2) Pressure water tanks; level controlling valves in tanks; water purification tanks; hot water tanks; wastewater treatment tanks for household purposes.

#### Class 12

(3) Fuel tanks for vehicles.

#### Class 20

(4) Water tanks of plastic for agricultural purposes; water tanks of plastic for household purposes; water tanks of plastic for industrial purposes; containers, not of metal, for transport; plastic storage containers for commercial and industrial use; non-metal and non-paper containers for storage and transport; containers, not of metal, for liquid fuel; jerrycans of plastic



**Application Number** 2,043,236  
**Language of Application** English

**Filing Date** 2020-07-30

## APPLICANT DETAILS

### Applicant

Shenzhen Lepower Electronic Co., Ltd.  
5th floor, Building C, the 2nd Industrial Zone  
Taoxia Village, Gaofeng Community  
Dalang Administration Committee, Longhua  
Shenzhen, 518000  
CHINA

## TRADEMARK DETAILS

# Sundu

### Trademark Type

Standard Characters

### Goods

#### Class 20

bathroom furniture; bedroom furniture; beds; bookcases; boxes of wood and plastic; bumper guards for furniture; cushions; dining room furniture; dinner wagons being furniture; inflatable furniture; kennels for household pets; living room furniture; mats for infant playpens; nesting boxes for household pets; non-metallic vats; office furniture; picture frames; pillows; plastic shipping and storage boxes; seat cushions; shelves for storage; sofas; storage closets; tables; wardrobes; wooden boxes

**Application Number** 2,044,200  
**International Registration Number** 1456089  
**Language of Application** English

**Filing Date** 2020-07-03

## APPLICANT AND AGENT DETAILS

### Applicant

Proper Mag Media Limited  
82 Silk Street  
MANCHESTER M4 6BJ  
UNITED KINGDOM

### Agent

KIMBERLEY CUNNINGHAM  
(BENNETT JONES LLP), 3200 TELUS  
HOUSE, SOUTH TOWER, 10020 - 100TH  
STREET, EDMONTON, ALBERTA, T5J0N3

## TRADEMARK DETAILS

# Hikerdelic

### Trademark Type

Standard Characters

### Goods

#### Class 18

(1) Garment bags for travel; bags made of imitation leather; bags for school; bags for sports; bags for sports clothing; bags made of leather; bags, namely, all-purpose carrying bags, tote bags and reusable shopping bags.

#### Class 25

(2) Sweat shirts; shorts; shirts; hooded tops as clothing; jackets; knit tops; t-shirts; socks; trousers; jog pants; training shoes; casual shoes; flip flops; sandals, casual boots; caps being headwear; knitted hats; polo shirts; leisure wear, namely, tops as casual clothing and bottoms as casual clothing; clothing for sports, namely, sports shirts and sports pants; clothing for children, namely, tops, bottoms, loungewear and socks.

**Application Number** 2,044,298  
**International Registration Number** 0483949  
**Language of Application** French

**Filing Date** 2020-07-20

## APPLICANT AND AGENT DETAILS

### Applicant

WALDEMAR LINK GmbH & Co. KG  
Barkhausenweg 10  
22339 Hamburg  
ALLEMAGNE

### Agent

GOWLING WLG (CANADA) LLP  
SUITE 1600, 1 FIRST CANADIAN PLACE, 100  
KING STREET WEST, TORONTO, ONTARIO,  
M5X1G5

## TRADEMARK DETAILS

### Trademark Type

Design

### Visual Representation



**Goods**

**Class 10**

Surgical instruments; implants, namely artificial joints, nails, screws, plates and pins for bones; medical apparatus, namely suction pumps, apparatus for electrosurgery, electric apparatus for diagnostics by way of ultrasound for medical use and X-ray diagnostic apparatus, catheters, surgical probes, cover sheets of synthetic material for medical and surgical use, namely medical table sheets for examination and operating tables and sterile surgical sheets; eye shields of synthetic material.

**Application Number** 2,044,759  
**Language of Application** English

**Filing Date** 2020-08-10

## APPLICANT AND AGENT DETAILS

### Applicant

Johnson & Johnson  
One Johnson & Johnson Plaza  
New Brunswick, NJ 08933-7001  
UNITED STATES OF AMERICA

### Agent

BERESKIN & PARR LLP/S.E.N.C.R.L., S.R.L.  
SCOTIA PLAZA, 40 KING STREET WEST,  
40th FLOOR, TORONTO, ONTARIO, M5H3Y2

## TRADEMARK DETAILS

# NEUTROGENA RAPID FIRING

### Trademark Type

Standard Characters

### Goods

#### Class 03

Anti-aging skincare preparations; skincare preparations, namely, cleansers, gels, lotions, moisturizers, facial and body scrubs, and serums

**Application Number** 2,045,048  
**Language of Application** English

**Filing Date** 2020-08-11

## APPLICANT AND AGENT DETAILS

### Applicant

Craig Thorn  
79 Norway Ave  
Hamilton  
ONTARIO  
L8M2V9

### Agent

JESSIE BELOT  
520 de Gaspe, unit 303, Montreal, QUEBEC,  
H3E1G1

## TRADEMARK DETAILS

# BAOS Podcast

### Trademark Type

Standard Characters

### Goods

#### Class 09

(1) audio tape recordings; downloadable multimedia news podcasts; downloadable radio podcasts

#### Class 25

(2) aprons; athletic clothing; baseball caps; baseball caps and hats; baseball shirts; beach clothes; belts; belts made out of cloth; capri pants; caps; cargo pants; casual clothing; casual clothing featuring pants, dresses and shorts; casual pants; casual shirts; children's shirts; cloth hats; clothing belts; clothing in particular pants; clothing in the nature of pants; clothing particularly pants; denim pants; dress pants; fashion hats; fleece pants; fleece shirts; golf caps; golf shirts; hats; jackets; jeans; jogging pants; knit shirts; knitted caps; knitted shirts; knitted sweaters; long sleeve shirts; long-sleeved t-shirts; men's shirts; mock turtleneck shirts; muscle shirts; night shirts; open-necked shirts; pants; polo shirts; promotional caps; promotional t-shirts; shirts; short pants; short-sleeve shirts; short-sleeved shirts; short-sleeved t-shirts; skull caps; sport shirts; sports caps and hats; sports clothing; sports shirts with short sleeves; sweat pants; sweat shirts; sweaters; sweatshirts; t-shirts; tee-shirts; track pants; women's shirts; yoga pants

### Services

#### Class 38

distribution of news podcasts; podcasting of news shows; providing streaming audio and video such as music, movies, television shows, music videos, news and sports webcasts via a website; streaming of audio and video via the Internet featuring music, movies, news, and sports

**Application Number** 2,045,314  
**International Registration Number** 1545777  
**Language of Application** English

**Filing Date** 2020-04-02

## APPLICANT AND AGENT DETAILS

### Applicant

STUDIO R330 INC.  
6-3-13, Minamiaoyama,  
Minato-ku  
Tokyo 107-0062  
JAPAN

### Agent

MACRAE & CO.  
326 Somerset Street West, Ottawa, ONTARIO,  
K2P0J9

## TRADEMARK DETAILS

### Trademark Type

Design

### Visual Representation

### Goods

#### Class 18

(1) Handbag frames; purse frames; horseshoes; leather and fur, unworked or semi-worked; industrial packaging containers of leather; clothing for domestic pets; bags, namely, folding briefcases, shoulder bags, gladstone bags, briefcases, carry-on bags, handbags, boston bags, rucksacks, purses, key cases, money pouches being coin purses, haversacks, travelling bags; vanity cases, not fitted; umbrellas and their parts; walking sticks; canes; metal parts of canes and walking-sticks; handles for canes and walking sticks

#### Class 25

(2) Clothing, namely, pants, jeans, dresses, skirts, tights, vests, anoraks, rainwear, wind resistant jackets, tank tops, pullovers, knit shirts, cardigans, parkas, jerseys, sweat shirts, sweat pants, leggings, men's suits, ties as clothing, women's suits, overalls, beachwear, loungewear, lingerie, infantwear, jackets, jumpers, socks, stockings, tights; coats; sweaters; shirts; nightwear; underwear, underclothing; swimwear, bathing suits; swimming caps, bathing caps; camisoles; tank-tops; tee-shirts; Japanese traditional clothing, namely, Japanese summer kimono (yukata); sleep masks; aprons; neck gaiters; socks and stockings other than special sportswear; puttees and gaiters; fur stoles; shawls; scarves, scarfs; Japanese style socks, namely Tabi; Japanese style socks covers, namely Tabi covers; gloves and mittens; neckties; neckerchieves; bandanas, neckerchiefs; thermal clothing and underwear; mufflers; ear muffs; nightcaps; headwear, namely, hats and caps; garters; sock suspenders; suspenders, braces; waistbands; belts; footwear, namely, slippers, sandals, sneakers; shoes and boots, other than athletic footwear; Japanese style wooden clogs, namely Geta; Japanese style sandals, namely Zori; masquerade costumes; special footwear for sports; clothes, namely, sports pants, sports overuniforms, sports jerseys, sport shirts, sports coats

**Services****Class 35**

Advertising the goods and services of others; on-line advertising of the goods and services of others on a computer network; promoting the sale of goods and services through a consumer loyalty program; promoting goods and services through the distribution of discount cards; promoting the sale of goods and services by awarding purchase points for credit card use; promoting the sale of goods and services through promotional contests and the distribution of related printed material; news clipping services; providing business information about newspaper articles; retail services or wholesale services for woven fabrics and beddings; retail services or wholesale services for clothing; retail services or wholesale services for footwear, other than special footwear for sports; retail services or wholesale services for bags and pouches; retail store services for vanity cases, not fitted, umbrellas, walking sticks and canes; wholesale store services for vanity cases, not fitted, umbrellas, walking sticks and canes; retail services or wholesale services for metal hardware; retail services or wholesale services for kitchen equipment, cleaning tools and washing utensils; retail services or wholesale services for cosmetics, toiletries, dentifrices, soaps and detergents; retail services or wholesale services for printed matter; retail services or wholesale services for paper and stationery; retail services or wholesale services for clocks, watches and spectacles, namely eyeglasses and goggles; retail services or wholesale services for air fragrance preparations; retail services or wholesale services for candles; retail services or wholesale services for clothing for domestic pets; retail services or wholesale services for flower vases; retail services or wholesale services for perfume and flavor materials and incense; retail services or wholesale services for shoe cream and shoe black, shoe polish; retail services or wholesale services for shoe horns, shoe brushes, insoles for shoes, shoe shine cloths and shoe trees, stretchers; retail services or wholesale services for toilet seat covers of textile, fitted toilet lid covers of fabric, fitted toilet paper holder covers of fabric; retail services or wholesale services for curtains and floor coverings

**Claims**

Priority Filing Date: February 27, 2020, Country or Office: JAPAN, Application No: 2020-020919 in association with the same kind of goods and in association with the same kind of services



**Application Number** 2,045,719  
**Language of Application** English

**Filing Date** 2020-08-13

## APPLICANT AND AGENT DETAILS

### Applicant

The Florence Melton Adult Mini-School  
Corporation  
520 Eighth Ave, 4th Floor  
New York, NY 10018  
UNITED STATES OF AMERICA

### Agent

DLA PIPER (CANADA) LLP  
Suite 2800, PARK PLACE, 666 BARRARD  
STREET, VANCOUVER, BRITISH  
COLUMBIA, V6C2Z7

## TRADEMARK DETAILS

### Trademark Type

Design

### Visual Representation



## Services

### Class 41

Educational services, namely, providing courses of instruction for adult education in the field of Judaism; educational services, namely, providing courses in the field of religion; educational services, namely, seminars with regard to current and historical locations related to the Jewish faith; online educational services, namely, providing courses of instruction for adult education in the field of Judaism; online educational services, namely, providing online courses in the field of religion

## Claims

Priority Filing Date: June 16, 2020, Country or Office: UNITED STATES OF AMERICA, Application No: 90/003,743 in association with the same kind of services

**Application Number** 2,045,720  
**Language of Application** English

**Filing Date** 2020-08-13

## APPLICANT AND AGENT DETAILS

### Applicant

The Florence Melton Adult Mini-School  
Corporation  
520 Eighth Ave, 4th Floor  
New York, NY 10018  
UNITED STATES OF AMERICA

### Agent

DLA PIPER (CANADA) LLP  
Suite 2800, PARK PLACE, 666 BARRARD  
STREET, VANCOUVER, BRITISH  
COLUMBIA, V6C2Z7

## TRADEMARK DETAILS

# NEVER STOP SEEKING

### Trademark Type

Standard Characters

### Services

#### Class 41

Educational services, namely, providing courses of instruction for adult education in the field of Judaism; educational services, namely, providing courses in the field of religion; educational services, namely, seminars with regard to current and historical locations related to the Jewish faith; online educational services, namely, providing courses of instruction for adult education in the field of Judaism; online educational services, namely, providing online courses in the field of religion

### Claims

Priority Filing Date: June 17, 2020, Country or Office: UNITED STATES OF AMERICA, Application No: 90/006,155 in association with the same kind of services

**Application Number** 2,046,919  
**International Registration Number** 1546835  
**Language of Application** English

**Filing Date** 2020-07-08

## APPLICANT AND AGENT DETAILS

### Applicant

Lady A Entertainment LLC  
2300 Charlotte Avenue,  
Suite 103  
Nashville, TN 37203  
UNITED STATES OF AMERICA

### Agent

ROBINSON SHEPPARD SHAPIRO S.E.N.C.R.  
L./L.L.P.  
STOCK EXCHANGE TOWER, 800 PLACE  
VICTORIA, BUREAU 4600, MONTREAL,  
QUEBEC, H4Z1H6

## TRADEMARK DETAILS

# LADY A

### Trademark Type

Standard Characters

### Goods

#### Class 09

(1) Series of musical sound recordings, namely, pre-recorded digital video discs and downloadable sound recordings; pre-recorded compact discs featuring musical entertainment.

#### Class 25

(2) Clothing, namely, T-shirts.

### Services

#### Class 41

Entertainment services in the nature of live performances, live music concerts, and personal appearances all by a musical group; entertainment services in the nature of audio and visual performances by a musical group; audio and video recording services; entertainment, namely, production of live theatrical shows, live musical shows, concerts, and videos; Entertainment services, namely, providing a Web site featuring musical performances, musical videos, related film clips and photographs in the field of musical entertainment; Entertainment services, namely, providing an ongoing series of audiovisual programs via the Internet in the field of music.

**Application Number** 2,047,697  
**Language of Application** French

**Filing Date** 2020-08-25

## APPLICANT DETAILS

### Applicant

Marylie Dionne  
1010-7001 Rue Prudent-Beaudry  
Mascouche  
QUÉBEC  
J7K0Z2

## TRADEMARK DETAILS

### Trademark Type

Design

### Visual Representation

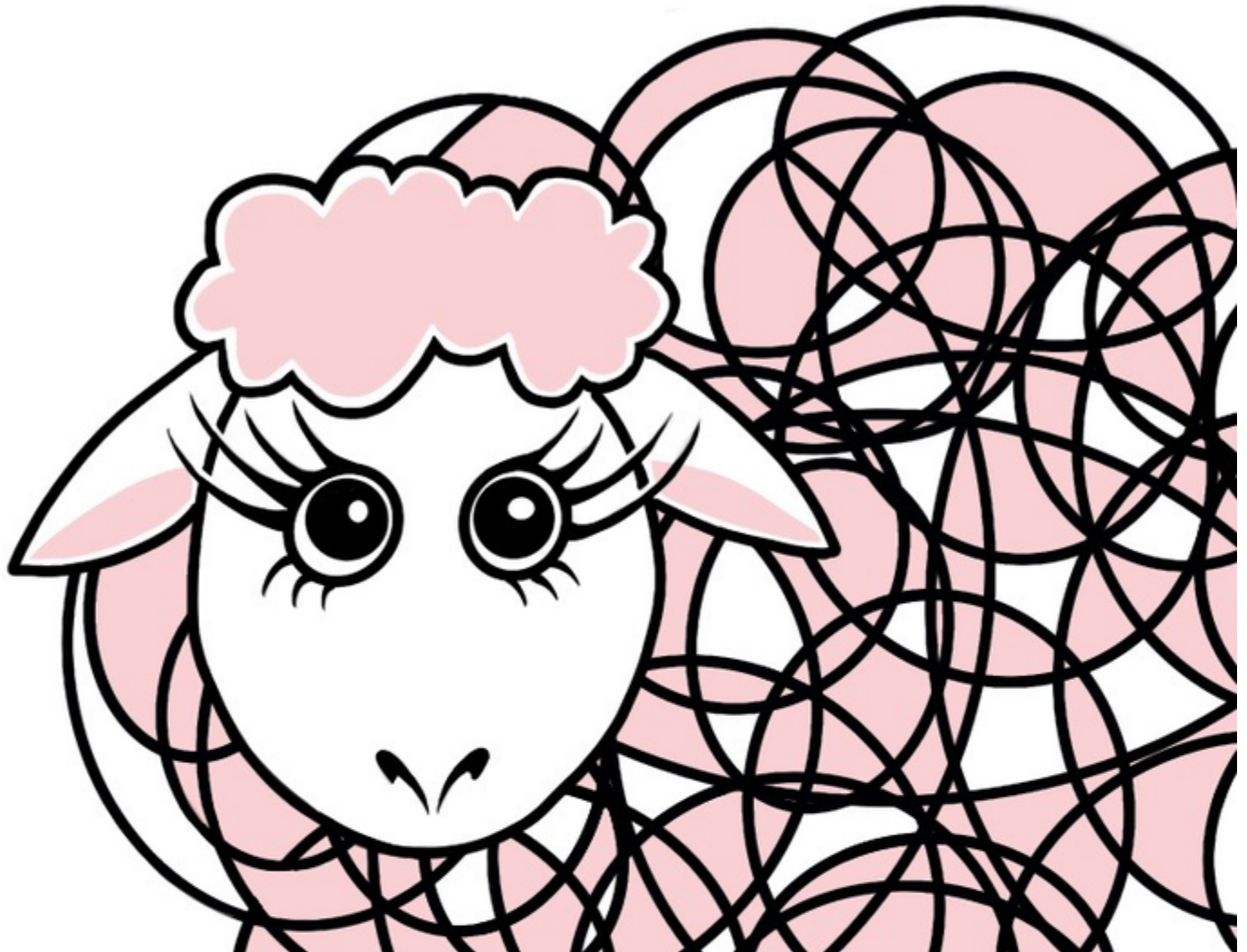

**Colour Claim**

Colour is claimed as a feature of the trademark. The words LE MOUTON are black. The word ROSE is pink. The design of the sheep and its distinguishing elements are represented by black lines. The sheep's face is white. Its eyes, eyelashes and nose are black. The wool on its head is pink. Its ears and body are a combination of pink and white.

**Services****Class 44**

beauty salons; beauty salons

**Application Number** 2,047,928  
**International Registration Number** 1547705  
**Language of Application** English

**Filing Date** 2020-03-13

## APPLICANT AND AGENT DETAILS

### Applicant

Qontigo GmbH  
Mergenthalerallee 61  
65760 Eschborn  
GERMANY

### Agent

GOWLING WLG (CANADA) LLP  
SUITE 1600, 1 FIRST CANADIAN PLACE, 100  
KING STREET WEST, TORONTO, ONTARIO,  
M5X1G5

## TRADEMARK DETAILS

# QONTIGO

### Trademark Type

Standard Characters

### Goods

#### Class 09

Computer programs for providing access to proprietary databases for use in managing, analyzing and reporting financial asset information in the fields of financial trading, financial risk management, financial brokerage services, stock exchange; computer software and programs for statistical analysis and the sending and receiving of information in the fields of financial trading and financial brokerage services; recorded computer programs for providing financial information and financial data only in connection with stock-exchange and financial services in the field of market securities, stocks, bonds, commodity trading, real estate, securities and assets; computer software for statistical evaluations of market research data in the fields of financial investment and financial trading; downloadable computer software platforms for use in financial services applications for portfolio optimization and construction, risk management, risk model construction, and regulatory reporting; computer software in the field of financial risk management, for the analysis and management of financial instrument portfolios; computer application software used to analyze and manage financial asset portfolios of equity, fixed income and other financial instruments being securities; software for collation, manipulation, analysis and reporting of financial information for use in the management of financial assets; software for accessing databases of financial information; downloadable computer application software and cloud software for use by professionals in the investment management industry to track, process, and manage regulatory reporting; software for performance and analytics and regulatory reporting for companies in the investment management industry.

### Services

#### Class 35

(1) Business consulting services in the investment management industry to provide use of on-line non-downloadable software for performance and analytics and regulatory reporting for companies in the investment management industry; business administration services, relating to maintaining, calculation, recording, compilation and systematization of statistics in the nature of stock market index figures, financial index figures, real estate index figures and other economic indices;

business administration, relating to compiling indices relating to stock-exchange securities, stocks, bonds, commodities, real estate, negotiable instruments and other classes of assets for business purposes; providing statistical information and indices of stock exchange dealings, valuables, interests, prices, exchange rates and other economic data, for others; commercial business administration of the licensing of goods and services of others, namely, stock indices and of licenses to banks and other financial institutions issuing derivatives and financial instruments, and granting loans, with payments computed by reference to financial and securities indices; commercial administration of licensing of stock indices and of licenses to insurance companies issuing insurance with payments to insured computed by reference to financial and related securities indices; compilation and systematization of statistics and index figures pertaining to stock exchange dealings, securities, prices; compiling, input and systematic ordering of information in the field of finance and capital market in databases; business risk management consultancy; economic forecasting and analysis; preparing business reports for others; business assistance in the field of outsourcing services in the field of business operations consisting of infrastructure, computer and software applications, finance and accounting; computer-assisted business information and research services and data compiling and analyzing business management information concerning stock exchange information; calculation, recording, creation, composition and systematization of statistics and indexes concerning stock exchange transactions, securities, interest rates, prices, exchange rates and other economic data; systematization and composition of financial information and data in a computer database; computer data processing services in the field of financial securities information via computer; recording of commercial business information with regulatory agencies namely, preparing financial reports for others containing financial information in the fields of stock-market securities, stocks, bonds, financial investment commodities, real estate, financial securities and financial assets for others; statistical evaluations of market studies ; business consulting services in relation to regulatory compliance; regulatory submission management, namely, business administration assistance for others in gathering data, preparing and filing financial applications for submission to governmental regulatory bodies; computerized database management; database management services relating to collecting, analyzing, updating and supplying data.

### **Class 36**

(2) Financial services, namely, creation, development, calculation, offer, maintenance and revision of financial instruments, namely, securities, options, bonds, futures, forward contracts, funds and index tracking funds, namely, exchange traded funds, and financial investment management consultancy in connection with the aforesaid services; providing financial information and financial investment data in the field of stock-market securities, stocks, bonds, commodity trading, real estate, securities and financial asset portfolios, and financial investment management consultancy in connection with the aforesaid services; banking and financial services, namely, financial portfolio management, financial analysis and financial analysis consultation, and financial investment management consultancy in connection with the aforesaid services; financial portfolio management, and financial investment management consultancy in connection with the aforesaid services; financial risk management consultancy and financial investment management consultancy in connection with the aforesaid services; investment analysis and financial investment management consultancy in connection with the aforesaid services; financial asset evaluation being financial asset management and financial investment management consultancy in connection with the aforesaid services; providing financial investment information via electronic means and financial investment management consultancy in connection with the aforesaid services; financial investment in the field of securities and financial investment management consultancy in connection with the aforesaid services; financial management services relating to



determining, calculating and publishing indices in connection with officially quoted securities and financial investment management consultancy in connection with the aforesaid services; providing information about stocks and securities via a global computer network and mail and financial investment management consultancy in connection with the aforesaid services; financial fund investment information and financial investment advisory services; financial fund investment information in the field of finance, markets, news and analytics and financial investment management consultancy in connection with the aforesaid services; providing financial brokerage of futures information for the composition and calculation of indices and financial investment information and financial investment management consultancy in connection with the aforesaid services; providing a financial securities index in the field of underlyings and benchmarks for financial investments and financial contracts and financial investment management consultancy in connection with the aforesaid services; trading of securities index futures, incorporating determining, calculating and publishing of indices and financial investment management consultancy in connection with the aforesaid services; providing of financial investment information for others in connection with index levels as a base for financial products and financial investment management consultancy in connection with the aforesaid services; stock exchange quotations; financial management services relating to determining, including calculating and publishing a stock index and financial investment management consultancy in connection with the aforesaid services; financial affairs, namely, financial administration of stock exchange trading of shares and financial securities in financial markets, banking, and financial investment brokerage services including trading of financial securities namely shares, units, futures contracts, metals and currencies and financial investment management consultancy in connection with the aforesaid services; financial management consultation provided to financial institutions for organization and administration of banking and financial affairs; financial management services relating to determination of and calculations concerning indices for securities and forward contracts, currencies, interest rates and economic factors; provision of financial investment information concerning share markets, currency markets and exchange rates, deposits, securities and financial asset information; provision of information on life insurance, financial estimates of committed capital, financial analyses and financial investment appraisals; provision of financial management information about credit facilities; investment risk assessment services and reports associated therewith; preparing financial reports for others; providing stock exchange quotations, determining a stock index and computerized analysis of stock exchange information; providing of financial investment management information for others in the fields of financial index levels as a base for financial investments in the fields of compiling financial, securities, stock exchange, trade and quote, index value and other financial market information for business purposes; providing financial investments based on indices, namely, providing financial indices of selected market data to enable users to evaluate investments and market trends in the financial sector; updating indices of stocks and securities for others.

#### **Class 42**

(3) Computer services, namely, cloud computing provider services for general storage of data; computer technical support services, namely, troubleshooting computer software problems; management of computer networks for others; providing virtual computer systems and virtual computer environments through cloud computing; monitoring of computer systems for detecting unauthorized access or data breach; design and development of computer software; installation of computer software; maintenance and updating of computer software; computer software advisory and consultancy services; installation, maintenance and repair of software for computer systems; computer programming for others in connection with stock exchange and financial services; technological consultancy in the field of computer software and computer software systems

management in the fields of financial management services, financial affairs, stock exchange trading, banking and financial brokerage services; computer services, namely research, development, technological consulting and electronic monitoring concerning use of computers and creation of data processing programs (computing services); computer systems analysis; platform as a service (PAAS) featuring computer software platforms for use in applications in financial services for portfolio optimization and construction, risk management, risk model construction, and regulatory reporting; recovery of electronic computer data; providing temporary use of software for use in financial services applications for portfolio optimization and construction, risk management, risk model construction, and regulatory reporting; providing temporary use of non-downloadable cloud-based software in the field of financial risk management, for the analysis and management of financial instrument portfolios; cloud computing featuring software in the field of financial risk management, for the analysis and management of financial instrument portfolios; providing temporary use of non-downloadable software for collation, manipulation, analysis and reporting of financial information for use in the management of financial assets; providing temporary use of non-downloadable software for providing access to proprietary databases online for use in managing, analyzing and reporting financial asset information; providing on-line non-downloadable software for performance management and statistical analytics and regulatory reporting for companies in the financial investment management industry; technological consultancy in the field of computer software for data analytics and tracking the performance of the stock exchange and of financial brokerage services being the trading, negotiation and custody of officially quoted securities, as well as shares, units, futures contracts, metals and currencies.

**Claims**

Priority Filing Date: September 13, 2019, Country or Office: GERMANY, Application No: 30 2019 021 386 in association with the same kind of goods and in association with the same kind of services

**Application Number** 2,047,929  
**International Registration Number** 1547706  
**Language of Application** English

**Filing Date** 2020-03-13

## APPLICANT AND AGENT DETAILS

### Applicant

Qontigo GmbH  
Mergenthalerallee 61  
65760 Eschborn  
GERMANY

### Agent

GOWLING WLG (CANADA) LLP  
SUITE 1600, 1 FIRST CANADIAN PLACE, 100  
KING STREET WEST, TORONTO, ONTARIO,  
M5X1G5

## TRADEMARK DETAILS

### Trademark Type

Design

### Visual Representation

**QONTIGO** 

### Goods

#### Class 09

Computer programs for providing access to proprietary databases for use in managing, analyzing and reporting financial asset information in the fields of financial trading, financial risk management, financial brokerage services, stock exchange; computer software and programs for statistical analysis and the sending and receiving of information in the fields of financial trading and financial brokerage services; recorded computer programs for providing financial information and financial data only in connection with stock-exchange and financial services in the field of market securities, stocks, bonds, commodity trading, real estate, securities and assets; computer software for statistical evaluations of market research data in the fields of financial investment and financial trading; downloadable computer software platforms for use in financial services applications for portfolio optimization and construction, risk management, risk model construction, and regulatory reporting; computer software in the field of financial risk management, for the analysis and management of financial instrument portfolios; computer application software used to analyze and manage financial asset portfolios of equity, fixed income and other financial instruments being securities; software for collation, manipulation, analysis and reporting of financial information for

use in the management of financial assets; software for accessing databases of financial information; downloadable computer application software and cloud software for use by professionals in the investment management industry to track, process, and manage regulatory reporting; software for performance and analytics and regulatory reporting for companies in the investment management industry.

## **Services**

### **Class 35**

(1) Business consulting services in the investment management industry to provide use of on-line non-downloadable software for performance and analytics and regulatory reporting for companies in the investment management industry; business administration services, relating to maintaining, calculation, recording, compilation and systematization of statistics in the nature of stock market index figures, financial index figures, real estate index figures and other economic indices; business administration, relating to compiling indices relating to stock-exchange securities, stocks, bonds, commodities, real estate, negotiable instruments and other classes of assets for business purposes; providing statistical information and indices of stock exchange dealings, valuables, interests, prices, exchange rates and other economic data, for others; commercial business administration of the licensing of goods and services of others, namely, stock indices and of licenses to banks and other financial institutions issuing derivatives and financial instruments, and granting loans, with payments computed by reference to financial and securities indices; commercial administration of licensing of stock indices and of licenses to insurance companies issuing insurance with payments to insured computed by reference to financial and related securities indices; compilation and systematization of statistics and index figures pertaining to stock exchange dealings, securities, prices; compiling, input and systematic ordering of information in the field of finance and capital market in databases; business risk management consultancy; economic forecasting and analysis; preparing business reports for others; business assistance in the field of outsourcing services in the field of business operations consisting of infrastructure, computer and software applications, finance and accounting; computer-assisted business information and research services and data compiling and analyzing business management information concerning stock exchange information; calculation, recording, creation, composition and systematization of statistics and indexes concerning stock exchange transactions, securities, interest rates, prices, exchange rates and other economic data; systematization and composition of financial information and data in a computer database; computer data processing services in the field of financial securities information via computer; recording of commercial business information with regulatory agencies namely, preparing financial reports for others containing financial information in the fields of stock-market securities, stocks, bonds, financial investment commodities, real estate, financial securities and financial assets for others; statistical evaluations of market studies; business consulting services in relation to regulatory compliance; regulatory submission management, namely, business administration assistance for others in gathering data, preparing and filing financial applications for submission to governmental regulatory bodies; computerized database management; database management services relating to collecting, analyzing, updating and supplying data.

### **Class 36**

(2) Financial services, namely, creation, development, calculation, offer, maintenance and revision of financial instruments, namely, securities, options, bonds, futures, forward contracts, funds and index tracking funds, namely, exchange traded funds, and financial investment management consultancy in connection with the aforesaid services; providing financial information and financial investment data in the field of stock-market securities, stocks, bonds, commodity trading, real

estate, securities and financial asset portfolios, and financial investment management consultancy in connection with the aforesaid services; banking and financial services, namely, financial portfolio management, financial analysis and financial analysis consultation, and financial investment management consultancy in connection with the aforesaid services; financial portfolio management, and financial investment management consultancy in connection with the aforesaid services; financial risk management consultancy and financial investment management consultancy in connection with the aforesaid services; investment analysis and financial investment management consultancy in connection with the aforesaid services; financial asset evaluation being financial asset management and financial investment management consultancy in connection with the aforesaid services; providing financial investment information via electronic means and financial investment management consultancy in connection with the aforesaid services; financial investment in the field of securities and financial investment management consultancy in connection with the aforesaid services; financial management services relating to determining, calculating and publishing indices in connection with officially quoted securities and financial investment management consultancy in connection with the aforesaid services; providing information about stocks and securities via a global computer network and mail and financial investment management consultancy in connection with the aforesaid services; financial fund investment information and financial investment advisory services; financial fund investment information in the field of finance, markets, news and analytics and financial investment management consultancy in connection with the aforesaid services; providing financial brokerage of futures information for the composition and calculation of indices and financial investment information and financial investment management consultancy in connection with the aforesaid services; providing a financial securities index in the field of underlyings and benchmarks for financial investments and financial contracts and financial investment management consultancy in connection with the aforesaid services; trading of securities index futures, incorporating determining, calculating and publishing of indices and financial investment management consultancy in connection with the aforesaid services; providing of financial investment information for others in connection with index levels as a base for financial products and financial investment management consultancy in connection with the aforesaid services; stock exchange quotations; financial management services relating to determining, including calculating and publishing a stock index and financial investment management consultancy in connection with the aforesaid services; financial affairs, namely, financial administration of stock exchange trading of shares and financial securities in financial markets, banking, and financial investment brokerage services including trading of financial securities namely shares, units, futures contracts, metals and currencies and financial investment management consultancy in connection with the aforesaid services; financial management consultation provided to financial institutions for organization and administration of banking and financial affairs; financial management services relating to determination of and calculations concerning indices for securities and forward contracts, currencies, interest rates and economic factors; provision of financial investment information concerning share markets, currency markets and exchange rates, deposits, securities and financial asset information; provision of information on life insurance, financial estimates of committed capital, financial analyses and financial investment appraisals; provision of financial management information about credit facilities; investment risk assessment services and reports associated therewith; preparing financial reports for others; providing stock exchange quotations, determining a stock index and computerized analysis of stock exchange information; providing of financial investment management information for others in the fields of financial index levels as a base for financial investments in the fields of compiling financial, securities, stock exchange, trade and quote, index value and other financial market information for business purposes; providing financial investments based on indices, namely, providing financial indices of selected market data to enable users to

evaluate investments and market trends in the financial sector; updating indices of stocks and securities for others.

### **Class 42**

(3) Computer services, namely, cloud computing provider services for general storage of data; computer technical support services, namely, troubleshooting computer software problems; management of computer networks for others; providing virtual computer systems and virtual computer environments through cloud computing; monitoring of computer systems for detecting unauthorized access or data breach; design and development of computer software; installation of computer software; maintenance and updating of computer software; computer software advisory and consultancy services; installation, maintenance and repair of software for computer systems; computer programming for others in connection with stock exchange and financial services; technological consultancy in the field of computer software and computer software systems management in the fields of financial management services, financial affairs, stock exchange trading, banking and financial brokerage services; computer services, namely research, development, technological consulting and electronic monitoring concerning use of computers and creation of data processing programs (computing services); computer systems analysis; platform as a service (PAAS) featuring computer software platforms for use in applications in financial services for portfolio optimization and construction, risk management, risk model construction, and regulatory reporting; recovery of electronic computer data; providing temporary use of software for use in financial services applications for portfolio optimization and construction, risk management, risk model construction, and regulatory reporting; providing temporary use of non-downloadable cloud-based software in the field of financial risk management, for the analysis and management of financial instrument portfolios; cloud computing featuring software in the field of financial risk management, for the analysis and management of financial instrument portfolios; providing temporary use of non-downloadable software for collation, manipulation, analysis and reporting of financial information for use in the management of financial assets; providing temporary use of non-downloadable software for providing access to proprietary databases online for use in managing, analyzing and reporting financial asset information; providing on-line non-downloadable software for performance management and statistical analytics and regulatory reporting for companies in the financial investment management industry; technological consultancy in the field of computer software for data analytics and tracking the performance of the stock exchange and of financial brokerage services being the trading, negotiation and custody of officially quoted securities, as well as shares, units, futures contracts, metals and currencies.

### **Claims**

Priority Filing Date: September 13, 2019, Country or Office: GERMANY, Application No: 30 2019 021 387 in association with the same kind of goods and in association with the same kind of services

**Application Number** 2,047,939  
**International Registration Number** 1547065  
**Language of Application** English

**Filing Date** 2020-04-03

## APPLICANT AND AGENT DETAILS

### Applicant

DAIKYO SEIKO, LTD.  
1305-1, Kurohakama-cho,  
Sano-shi  
Tochigi 327-0813  
JAPAN

### Agent

MARKS & CLERK  
33 Yonge Street, , Suite 300, Toronto,  
ONTARIO, M5E1G4

## TRADEMARK DETAILS

### Trademark Type

Design

### Visual Representation

The image shows the word 'DAIKYO' in a large, bold, blue, serif font. The letters are spaced out and are the primary visual element of the trademark.

### Colour Claim

Colour is claimed as a feature of the trademark. The word 'DAIKYO' is in the colour blue.

### Goods

#### Class 10

(1) Infusion plugs for use with injection devices for administering drugs; rubber stoppers for use with instruments for medical infusion; rubber stoppers for use with medical vials; rubber closures for medical infusion bags; rubber closures for medical infusion bottles; rubber stoppers for use with medical instruments; medical syringes; injection syringes [syringe barrels] for medical purposes; pistons for use with medical syringes; plungers for use with medical syringes; adapters for use with medical syringes; nozzle caps for use with medical syringes; rubber stoppers for use with infusion devices for administering drugs for therapeutic purposes; medical retaining caps for preventing rubber closures that seal mouths of medicine containers from coming off; medical sealing caps with built-in rubber closures for sealing mouths of medicine containers; medical rubber caps for use with instruments for the injection of medicines; rubber stoppers and closures being structural parts of medical instruments for use with medical containers for medical aqueous infusion purposes; O-rings for medical use for use with medicine inhaling instruments; connectors for infusion tubes and intravenous tubes; medical diagnostic and analytical apparatus, namely, microplates for medical use; injection solution cartridges for pen-shaped medical syringes; rubber stoppers for injection solution cartridges for pen-shaped medical syringes; syringe barrels with a needle for medical purposes in the nature of medical injection syringes; caps for syringe barrels with a needle for medical purposes in the nature of medical injection syringes; medical syringes of

the type that pharmaceutical preparations are filled before their supply to end users in the nature of prefilled medical syringes; injection solution containers that are loaded and filled in medical syringe barrels in the nature of medical injection syringes and medical cartridge syringes; rubber closures for medical vials; stoppers for medical infusion bags; stoppers for medical infusion bottles; rubber closures for medical containers used to store pharmaceutical raw materials and intermediate products; rubber closures specially adapted for medical containers used for production of medicines, namely pharmaceutical raw materials, intermediates and final products; rubber closures and stoppers specially adapted for medical blood collecting tubes; nozzle caps for needle-detachable syringes; caps for nozzle-shaped parts in dialysis systems; medical plastic retaining caps for preventing rubber closures that seal mouths of vial containers for medicines from coming off; medical plastic sealing caps with built-in rubber closures for sealing mouths of vial containers for medicines.

### **Class 17**

(2) O-rings of rubber; industrial packaging containers of rubber; rubber stoppers for medicine containers; rubber lids and caps for industrial packaging containers; rubber lids and caps for medicine containers; raw rubber and semi-worked rubber; rubber stoppers for industrial packaging containers; rubber stoppers for medical microplates; rubber stoppers for use in encapsulating medicinal solutions

### **Class 20**

(3) Packaging containers of plastic for use in storing medicines; packaging containers of plastic; medicine storage containers of plastic; plastic retaining caps for preventing rubber closures that seal mouths of containers for use in freezing and drying from coming off; plastic retaining caps for preventing rubber closures that seal mouths of packaging containers from coming off; plastic sealing caps with built-in rubber closure for sealing mouths of containers for use in freezing and drying; plastic sealing caps with built-in rubber closure for sealing mouths of packaging containers; plastic lids and caps for packaging containers; plastic caps for drug and medicine containers; rubber closures for medicine containers; rubber closures for use with medical vial containers; containers for the storage of medicines; plastic based containers for commercial packaging in the nature of medication bottles; packaging containers of plastic for the storage of medications; packaging containers of plastic for the storage of infusion kits; packaging containers of plastic for intravenous solutions; packaging containers of plastic for the storage of parenteral medical solutions; packaging containers of plastic for the storage of medical instruments; vial-shaped plastic containers for medical purposes for use in storing parenteral drugs.

### **Class 21**

(4) Ampoule-shaped plastic vessels; vial-shaped plastic bottles; plastic bottles sold empty for medical use; vial-shaped vessels for medicine.

### **Claims**

Priority Filing Date: March 17, 2020, Country or Office: JAPAN, Application No: 2020-029019 in association with the same kind of goods



**Application Number** 2,048,012  
**International Registration Number** 1547647  
**Language of Application** English

**Filing Date** 2020-06-08

## APPLICANT AND AGENT DETAILS

### Applicant

Foshan Sitzzone Furniture Co.,Ltd.Goodtone  
Branch  
No.18 East, QiaoGao Road,  
Haizhou Industrial Area,  
Xiqiao Town, Nanhai Area, Foshan City  
Guangdong Province  
CHINA

### Agent

BENOÎT & CÔTÉ INC.  
560 boul. Crémazie Est, 3e étage, Montréal,  
QUEBEC, H2P1E8

## TRADEMARK DETAILS

### Trademark Type

Design

### Visual Representation

The image shows the word "Goodtone" in a very large, bold, black, sans-serif font. The letters are thick and closely spaced, with a modern, clean aesthetic. The 'G' is particularly large and rounded, and the 'e' at the end is also large and rounded. The overall appearance is that of a strong, memorable brand name.

### Goods

#### Class 20

Office furniture; office tables; office chairs; sofas; chests, not of metal; screens for fireplaces; mirrors; furniture fittings, not of metal; cushions; indoor window blinds.

**Application Number** 2,048,126  
**International Registration Number** 1547553  
**Language of Application** English

**Filing Date** 2020-07-16

## APPLICANT AND AGENT DETAILS

### Applicant

PALETTE LIFE SCIENCES, INC.  
310 N. Westlake Blvd., Suite 120  
Westlake Village CA 91362  
UNITED STATES OF AMERICA

### Agent

OYEN WIGGS GREEN & MUTALA LLP  
480-THE STATION, 601 WEST CORDOVA  
STREET, VANCOUVER, BRITISH  
COLUMBIA, V6B1G1

## TRADEMARK DETAILS

### Trademark Type

Design

### Visual Representation



  
**Trademark Description**

The mark consists of a stylistic image of the capital letter "P" formed by two semicircles and a quarter circle.

**Goods****Class 05**

Biological preparations for the treatment of cancer, namely prostate cancer; biological preparations for the treatment of cancer, namely preparations for use in cancer radiation therapy; biological preparations for the treatment of cancer, namely preparations for the protection of tissues in cancer treatment; injectable gels for use in the treatment and repair of joint cartilage; pharmaceutical preparations and substances for the treatment of gastro-intestinal diseases; pharmaceutical preparations and substances for the treatment of viral, metabolic, musculoskeletal, cardiovascular, sexual dysfunction, oncological, hepatological, ophthalmic, respiratory, gastrointestinal, hormonal diseases and disorders; pharmaceutical preparations for ocular or intraocular surgery; pharmaceutical preparations for treating allergic rhinitis and asthma; pharmaceutical preparations for treating and preventing tendon and muscle injuries and disorders, and for knee cartilage regeneration; pharmaceutical preparations for use in urology; pharmaceutical preparations for use in urology namely for the treatment of vesicoureteral reflux; pharmaceutical preparations for use in urology namely for the treatment of urinary incontinence; pharmaceutical preparations for use in urology namely for the treatment of fecal incontinence; pharmaceutical preparations for use in urology namely for the treatment of mucosal pain relief; pharmaceutical preparations for the treatment of eye diseases and conditions; pharmaceutical preparations for the treatment of musculo-skeletal disorders; pharmaceutical products and preparations to prevent stretch marks; pharmaceutical products for the prevention and treatment of cancer.

**Claims**

Priority Filing Date: April 08, 2020, Country or Office: UNITED STATES OF AMERICA, Application No: 88864762 in association with the same kind of goods

**Application Number** 2,048,395  
**Language of Application** English

**Filing Date** 2020-08-27

## APPLICANT AND AGENT DETAILS

### Applicant

Urban Outfitters Wholesale, Inc.  
5000 South Broad Street  
Philadelphia, Pennsylvania 19112  
UNITED STATES OF AMERICA

### Agent

DEETH WILLIAMS WALL LLP  
150 YORK STREET, SUITE 400, TORONTO,  
ONTARIO, M5H3S5

## TRADEMARK DETAILS

# INTIMATELY FREE PEOPLE

### Trademark Type

Standard Characters

### Services

#### Class 35

Retail store services, retail department store services and online retail store services in the field of clothing, footwear, headgear, jewelry, wedding related items, namely, wedding related clothing and wedding related clothing accessories, namely, dresses, shoes, veils, slips, hair combs and hair clips, capelets and shawls, scarves, belts, and jewellery, handbags, bags, wallets, cosmetics, personal care items and gifts, namely, cleansing pads, colognes, cotton swabs and pads, deodorant, facial tissues, lip gloss and lipstick, body lotion, hand soap, facial and body cleansers, skin moisturizers, baby powder, toothpaste, shampoo and fragrances; customer loyalty services and customer club services for commercial, promotional and advertising purposes

**Application Number** 2,049,049  
**Language of Application** English

**Filing Date** 2020-09-02

## APPLICANT AND AGENT DETAILS

### Applicant

TROESDE PET FREEZE-DRIED FOOD CORP.  
32904 Alta Ave  
Abbotsford  
BRITISH COLUMBIA  
V2S6P9

### Agent

MARK W. TIMMIS  
(MARK TIMMIS LAW CORPORATION), 2595  
CAVENDISH AVENUE, VICTORIA, BRITISH  
COLUMBIA, V8R2G5

## TRADEMARK DETAILS

### Trademark Type

Design

### Visual Representation

**hagi.tales**

### Goods

#### Class 31

pet food; grains for animal consumption; lime for animal forage; dog biscuits; wheat germ for animal consumption; fodder; forage; food for pets; residual products of cereals for animal consumption; edible chews for animals; pet beverages; fish meal for animal consumption; straw litter; gravel paper for bird cages; aromatic sand litter for pets

**Application Number** 2,049,053  
**Language of Application** English

**Filing Date** 2020-09-02

## APPLICANT AND AGENT DETAILS

### Applicant

TROESDE PET FREEZE-DRIED FOOD CORP.  
32904 Alta Ave  
Abbotsford  
BRITISH COLUMBIA  
V2S6P9

### Agent

MARK W. TIMMIS  
(MARK TIMMIS LAW CORPORATION), 2595  
CAVENDISH AVENUE, VICTORIA, BRITISH  
COLUMBIA, V8R2G5

## TRADEMARK DETAILS

### Trademark Type

Design

### Visual Representation



### Goods

#### Class 31

pet food; grains for animal consumption; lime for animal forage; dog biscuits; wheat germ for animal consumption; fodder; forage; food for pets; residual products of cereals for animal consumption; edible chews for animals; pet beverages; fish meal for animal consumption; straw litter; gravel paper for bird cages; aromatic sand litter for pets

**Application Number** 2,049,697  
**Language of Application** English

**Filing Date** 2020-09-03

## APPLICANT DETAILS

### Applicant

Coldstream Games Corp.  
8100 Postill Dr  
Coldstream  
BRITISH COLUMBIA  
V1B1T7

## TRADEMARK DETAILS

### Trademark Type

Design

### Visual Representation



### Colour Claim

Colour is claimed as a feature of the trademark. stylized die with a tri colour blue swooshy wave and a single blue dot in the center turquoise - hex #5dc8d6 - dot in center, first section below the top of the wave crest, outer section without trim navy blue - hex # 003462 - edge of waves definition line separating the other colours, dark section to the right of the dot in the center medium turquoise - hex #00aaba - first wave section to the left of the dot in the center dark teal - hex #007b98 - lowest section below the dot in the center medium teal - hex #00a0b0 - section above dark teal below the dot in the center teal - hex #31b3c2 - section above medium teal below the dot in the center dark turquoise - hex #008a98 - horizon, first section below the dot in the center off white - hex #f4fbfe - center of die surrounding the dot pale blue - hex #ebf7fa - crest of wave

### Goods

#### Class 28

board games

**Application Number** 2,050,517  
**International Registration Number** 1549863  
**Language of Application** English

**Filing Date** 2020-02-27

## APPLICANT AND AGENT DETAILS

### Applicant

BRIDGESTONE CORPORATION  
1-1, Kyobashi 3-chome,  
Chuo-ku  
Tokyo 104-8340  
JAPAN

### Agent

DEETH WILLIAMS WALL LLP  
150 YORK STREET, SUITE 400, TORONTO,  
ONTARIO, M5H3S5

## TRADEMARK DETAILS

# Solutions For Your Journey

### Trademark Type

Standard Characters

### Goods

#### Class 06

(1) Metal junctions for pipes; metal flanges; valves of metal, not being parts of machines, namely, manually operated ball valves of metal, manually operated butterfly valves of metal, manually operated diaphragm sampling valves of metal, manually operated gate valves of metal, manually operated check valves of metal; water-pipe valves of metal; pipework of metal; antiseismic construction materials of metal; construction materials of metal, namely, reinforcement materials for building; reinforcing materials of metal for pipes; nuts of metal; water tanks of metal for household purposes; steel frames for building; industrial stainless steel water tanks; containers of metal for transport; storage containers of metal; rubber covered metal chains for preventing bridge collapse.

#### Class 07

(2) Construction machines and apparatus, namely, earth moving machines, namely earth haulers, earth moving scrapers, excavators, road scrapers, motor graders, backhoes, loaders, namely front-end loaders, back-hoe loaders, skid steer loaders, cranes, asphalt pavers, earth compacting machines, belt conveyors, pipe conveyors and hoses being parts of construction machines and parts and fittings for the aforesaid goods; cargo handling machines and apparatus, namely, cargo lifting derricks, and unmanned robots being cargo handling machines, and parts and fittings for the aforesaid goods; mining machines and apparatus, namely, earth moving machines in the nature of earthmovers, namely, earth haulers, earth moving scrapers, scrapers, motor graders, shovel loaders, bulldozers, wheeled cranes, cranes, compact track loaders, multi terrain loaders, belt conveyors, overland conveyors, pipe conveyors, inclined conveyors, coal loaders, mineworking machines, namely, machines for geological, mining and ore exploration, drills for mining, extractors for mines, mine borers, mine winches, and ore treating machines and parts and fittings for the aforesaid goods; rubber tracks for use with crawlers on agricultural machinery, and parts and fittings for the aforesaid goods; rubber tracks for use with crawlers on mining machinery, and parts and fittings for the aforesaid goods; rubber tracks for use with crawlers on construction, cargo handling machinery, and parts and fittings for the aforesaid goods; rubber pads to be attached to





working machines, non-electric prime movers, pneumatic or hydraulic machines, repairing and fixing machines, mechanical parking systems, vehicle washing installations, power sprayers for disinfecting, insecticides and deodorants, lawnmowers, curtain drawing devices electrically operated, waste compacting machines and waste crushing machines; hydraulic connectors (pipes) being parts of metalworking machines, mining machines, construction machines, loading-unloading machines, fishing machines, chemical processing machines, textile machines, food processing machines, beverage processing machines, lumbering machines, woodworking machines, veneer or plywood making machines, pulp making machines, papermaking machines, paper-working machines, printing machines, bookbinding machines, agricultural machines, shoe making machines, leather tanning machines, tobacco processing machines, glassware manufacturing machines, painting machines, packaging or wrapping machines, plastic processing machines, semiconductor manufacturing machines, rubber goods manufacturing machines, stone working machines, non-electric prime movers, pneumatic or hydraulic machines, repairing and fixing machines, mechanical parking systems, vehicle washing installations, power sprayers for disinfecting, insecticides and deodorants, lawnmowers, curtain drawing devices electrically operated, waste compacting machines and waste crushing machines; tire repairing machinery, namely, power-operated machines for repairing tires; pressure chambers as parts of tire repairing machinery; tire buffers as parts of tire repairing machinery; tire tread rollers and stitchers, as parts of tire repairing machinery; tire tread cutters and bonding agent applicators used in recapping tires as parts of tire repairing machinery; pneumatic shock absorbers (air springs, for machine elements not for land vehicles); rubber springs for non-vehicular suspension systems; screen filters made of plastic for mining machines and apparatus; screen filters made of plastic for stone working machines and apparatus; fuel dispensing machines for service stations; gasoline pumps for service stations.

### **Class 09**

(3) Batteries, namely, automotive batteries, batteries for mobile phones, electric batteries for powering electric vehicles, general purpose batteries, ignition batteries; solar batteries; telecommunication machines and apparatus, namely, computer network routers, multiplexers, computer hardware for telecommunications, computer hardware and recorded software for setting up and configuring wide area networks, telecommunication apparatus for measuring, monitoring, and transmitting tire pressure and tire temperature, namely, radio transmitters and receivers, satellite transmitters, GPS transmitters, telephone transmitters, video transmitters, audio- and video-receivers, temperature sensors, and tire pressure sensors; facsimile machines; electronic machines, apparatus and their parts, namely, electronic measurement machines and instruments for measuring, monitoring, and transmitting tire pressure and tire temperature, namely, electronic apparatus comprising temperature sensors, tire pressure sensors, radio antennas, radio transmitters and receivers, and computer software for monitoring tire pressure and tire temperature; electronic displays utilizing electronic paper technology, namely, computer display monitors; computers; structural parts of computer printers, facsimile machines and photocopying machines, namely, transfer rollers, toner supply rollers and development rollers; measuring apparatus and instruments, namely, pressure gauges, pressure sensors, lasers for measuring purposes; measuring and testing machines and instruments, namely, sensors and gauges for measuring and testing the temperature and pressure of oil, water, automotive fluids, and air in engines, motors, drive trains, transmissions, and tires; alarm devices for tire pressure; measuring and alarm devices for tire pressure; pressure gauges in vehicle tires; tire pressure gauges; gasoline gauges; rubber testing machines; photographic machines and apparatus in the nature of photographic cameras and accessories therefor, namely, camera tripods, camera monopods, camera shutters, self-timers for cameras, film magazines for cameras, lens filters for cameras,

straps for cameras; cinematographic machines and apparatus, namely, cinematographic cameras, cinematographic projectors, colour filters for television and cinematographic cameras, editing appliances for cinematographic films, projection screens for cinematographic films; cameras; dust masks; electronic circuits and CD-ROMs recorded with programs for hand-held games with liquid crystal displays; weight belts for scuba diving; downloadable music files; downloadable image files; downloadable electronic publications in the nature of books, newsletters, magazines, pamphlets, workbooks, journals, and hand-outs provided on-line from databases and the Internet; electric batteries, namely, electric batteries for cameras, electric batteries for portable computers, electric batteries for powering electric vehicles, electric batteries for smartphones, electric batteries for watches and electric storage batteries; batteries, electric, for vehicles; sunglasses; battery chargers for mobile phones; fire hoses; computer software for monitoring, analyzing flight data and predicting treadwear of tires; checking (supervision) apparatus and instruments, namely, tire depth gauges, tools to detect cracks on products by means of camera, light or air; holders for hand-held computers; satellite transmitters and receivers, radio transmitters and receivers; signaling apparatus and instruments, namely, flashing safety lights for vehicles and flashing safety lights for traffic cones; software for operating electronic digital dictionaries; telecommunications installations, networks and apparatus, namely, radio transmitters and receivers, satellite transmitters, GPS transmitters, telephone transmitters, video transmitters, audio- and video-receivers, mobile phones; mounting racks for telecommunications computer hardware; telematics apparatus, namely wireless Internet-enabled devices in the nature of on-board computers, GPS receivers and GPS transmitters which provide telematics services and have a cellular phone function; barcode scanners; two-dimensional code scanners; printers, namely, thermal printers, inkjet printers, laser printers; surveying instruments; computer hardware and software for use with satellite and GPS navigation systems for navigation purposes; computer software for operating satellite navigational systems and global positioning systems [GPS], and for use of global positioning systems [GPS] for tracking, locating and security of vehicles and objects; computer software for use with route planners, electronic maps and digital dictionaries for navigation purposes; computer terminals, all in particular for the use of navigation systems, route planners, and digital maps; downloadable electronic maps; global positioning systems [GPS] consisting of computers, computer software, transmitters, receivers, and network interface devices; location, orientation and navigation, and global positioning systems [GPS] consisting of computers, computer software, transmitters, global positioning system [GPS] receivers and satellite receivers; mobile computing and operating platforms consisting of data transceivers, wireless networks and gateways for collection and management of data; navigation apparatus for vehicles in the nature of on-board computers; route planners in the form of hand-held personal computers (hand-held computers); satellite navigational systems, namely global positioning systems consisting of satellites, computers, computer software, transmitters, receivers, and network interface devices; computer software for database management in the field of transportation and traffic; software for management and maintenance of groups of vehicles, namely, software for tracking and monitoring vehicles, and for scheduling and management of vehicle maintenance, for use in the field of vehicle management; software for operating route planners; software for in-vehicle navigation and entertainment systems for providing and displaying travel advice on petrol stations, car parks, restaurants, hotels and car dealers; computer software for displaying orders and vehicle locations on maps; software to indicate maintenance requirements and maintenance scheduling for vehicles; vehicle locating, tracking and security systems comprised of antennas and radio transmitters to be placed in vehicles; vehicle locator and recovery devices programmed to use global positioning systems [GPS] and cellular telecommunications; downloadable electronic databases containing information relating to tires, vehicle parts, vehicles and groups of vehicles; electronic publications relating to tires, vehicle parts, vehicles and groups of vehicles; electronic reports relating to tires, vehicle

parts, vehicles and groups of vehicles; electronic sensing, checking, monitoring and communication devices used in relation to vehicles, tires, vehicle parts and groups of vehicles, namely, telecommunication devices comprised of receivers, transmitters and computer hardware and software for collecting, tracking, storing, managing, reporting, and transmitting tire and vehicle telematics data; electronic sensors for tires, vehicles and vehicle parts, namely, temperature sensors, pressure sensors, acceleration sensors, distance sensors, velocity sensors, tire abrasion sensors, and road surface condition sensors; downloadable software for arranging and managing subscription services relating to monitoring, maintenance, replacement and purchase of tires and vehicle parts; downloadable software for arranging the replacement, repair, inspection, installation, monitoring, management, maintenance, ordering and purchase of tires, vehicle parts and vehicles; software used in relation to tires, vehicle parts, vehicles and groups of vehicles, namely, computer software for collecting, tracking, storing, managing, reporting, and transmitting tire and vehicle telematics data; downloadable software applications for use in monitoring and tracking tires and tire data, namely, tire deflection data, tire pressure data, tire abrasion data, vehicle speed data, and road surface condition data; computer software for vehicle fleet management; computer software for use in managing, tracking, and optimizing fleet operation costs and productivity based on commercial fleet tire data; computer software for use in monitoring tracking and reporting tire treadwear data, and predicting potential risky driving conditions for tires and allow vehicles to react to such conditions to prevent accident; downloadable software applications for analyzing treadwear of tires based on pictures; accident preventing systems primarily comprising sensors, namely, proximity sensors, pressure sensors, vehicle speed sensors, tire rotation speed sensors, computer software and computer hardware for measuring and transmitting tire treadwear data; tire treadwear detecting systems primarily comprising treadwear detecting sensors, low tire pressure automatic indicators, electric sensors, namely, pressure sensors, GPS and radio transmitters, GPS and radio receivers, and electronic display interfaces, namely, display screens; computer software for reporting the performance and condition of tires in retreading tires; computer software for tire retread dealers to track, photograph, and provide receipts for retreaded tires; computer software for tracking inventory of retread tires; computer software for information tracking and reporting functions in the retread tire business in the field of customer relationship management, supply chain management, human services, and financial applications, all designed to help businesses in the retread, commercial, retail and wholesale tire industry; tire pressure monitoring systems comprising a computer, pressure sensors, radio, GPS, and satellite antennas, GPS and radio transmitters, GPS and radio receivers and computer software for measuring and transmitting tire pressure data; tire pressure and temperature monitoring and measuring machines and instruments; electronic machines and apparatus for measuring, monitoring and transmitting tire pressure and tire temperature comprising sensors, namely, tire pressure sensors, tire temperature sensors, tire abrasion sensors, vehicle speed sensors, and road surface condition sensors, GPS and radio antennas, GPS and radio transmitters, GPS and radio receivers, display screens, personal digital assistants, mobile telecommunication terminals, namely, smart terminals, smart phones, smart tablets and computer software for measuring, monitoring and transmitting tire pressure and tire temperature; electronic machines and apparatus for technological and scientific use comprising tire pressure sensors, tire temperature sensors, tire abrasion sensors, vehicle speed sensors, and road surface condition sensors, radio antennas, GPS antennas, wireless transmitters and receivers, namely, GPS and radio transmitters and receivers, and computer software for monitoring tire pressure; computer software for monitoring vehicle drive information, vehicle kinetic information and tire pressure information; terminal devices, namely, computer terminals for collecting and storing information and data measured and saved by on-demand remote monitors and transmitters; data transmitting devices for telecommunication, namely, telecommunication transmitters in the nature of GPS transmitters and satellite transmitters,

television transmitters, radio transmitters; computer software for monitoring and managing pressure in tires; tire pressure management and monitoring systems comprising sensors, namely, tire pressure sensors, tire temperature sensors, tire abrasion sensors, vehicle speed sensors, and road surface condition sensors, computer software for measuring, monitoring and transmitting tire pressure data, and computer hardware; downloadable software applications for a mobile device or computer for use in monitoring, tracking, and reporting tire pressure and temperature; tire pressure management and monitoring systems primarily comprising sensors, namely, tire pressure sensors, tire temperature sensors, tire abrasion sensors, vehicle speed sensors, and road surface condition sensors, computer software and computer hardware for measuring and transmitting tire deflection and pressure data; tire pressure and tire temperature monitoring systems primarily comprising downloadable software for monitoring tire pressure and tire temperature, low tire pressure automatic indicators, tire pressure gauges, electric sensors, namely, tire pressure sensors, tire temperature sensors, tire abrasion sensors, vehicle speed sensors, and road surface condition sensors, GPS and radio transmitters, GPS and radio receivers, and electronic display interfaces, namely, display screens.

#### **Class 10**

(4) Artificial limbs; rubber soles for artificial limbs; artificial limbs for animals.

#### **Class 11**

(5) Water-pipes for sanitary installations; water control valves for faucets; tap water faucets; level controlling valves in tanks; pipe line cocks.

#### **Class 12**

(6) Automobiles and their parts and fittings; vehicle tires; tires for passenger cars; tires for trucks; tires for buses; tires for racing cars; tires for automobiles; retreaded tires for passenger cars; retreaded tires for trucks; retreaded tires for buses; retreaded tires for racing cars; retreaded tires; retreaded tires for automobiles; inner tubes for passenger cars; inner tubes for trucks; inner tubes for buses; inner tubes for racing cars; inner tubes for automobiles; wheels and rims for passenger cars; wheels and rims for trucks; wheels and rims for buses; wheels and rims for racing cars; wheels and rims for automobiles; tread rubber for retreading tires for vehicles, namely, passenger cars, trucks, buses, and racing cars; two-wheeled motor vehicles and their parts and fittings; tires for two-wheeled motor vehicles; inner tubes for two-wheeled motor vehicles; wheels and rims for two-wheeled motor vehicles; bicycles and their parts and fittings; tires for bicycles; inner tubes for bicycles; wheels and rims for bicycles; aircraft and their parts and fittings; tires and inner tubes for aircraft; adhesive rubber patches for repairing tubes or tires; tread rubber for retreading tires for two-wheeled motor vehicles or bicycles; tread rubber for retreading tires for aircraft; treads used to retread tires for tires of automobiles, two-wheeled motor vehicles, bicycles, and aircraft; preformed tire treads for tires of automobiles, two-wheeled motor vehicles, bicycles, and aircraft; rubber patches for repairing tire treads for vehicles, namely, automobiles, passenger cars, trucks, buses, racing cars, two-wheeled motor vehicles, bicycles and aircraft; shock absorbers, machine elements for land vehicles; springs, machine elements for land vehicles; air springs, machine elements for land vehicles; mechanical elements for land vehicles, namely, front derailleurs, rear derailleurs, gearing mechanisms in the nature of gear changing mechanisms, namely, speed change gears for land vehicles, transmissions and gear trains for land vehicles, suspension springs, brake levers, front brakes, rear brakes, brake cables, brake shoes, brakes for land vehicles, engine mounts for land vehicles, axle boot kits, suspension struts, drive shafts for land vehicles, shock absorbers, air springs for vehicle suspension, valves, namely, valve stems for vehicle tires, valves for vehicle tires, cocks for steam brakes, brake cylinders; shaft couplings or connectors, machine elements for land vehicles; vessels in the form of boats and ships and their

structural parts; fenders for vessels (boat side protectors); seat cushions for vehicles; air springs for railway cars; vehicle bumpers; suspension shock absorbers for vehicles; suspension springs for vehicles; tires for off-the-road automobiles, two-wheeled motor vehicles and bicycles; off-the-road vehicles and their parts and fittings; off-the-road two-wheeled vehicles and bicycles and their parts and fittings; tires for tractors; tires for agricultural vehicles; tires for container handling vehicles; rubber tracks for use with crawlers on snowmobiles; rubber tracks for use with crawlers on all terrain vehicles; rubber tracks for use with crawlers on automobiles; tires for lunar rovers; tires for scrapers; tires for motor graders; tires for shovel loaders; tires for tire rollers; tires for wheeled cranes; tires for cranes; tires for snow plows; tires for pavers; tires for mining machinery; cigar lighters for automobiles; cargo handling machines and apparatus, namely, cargo handling vehicles, namely, forklift trucks.

### **Class 17**

(7) Gaskets of metal; valves of rubber or vulcanized fiber [not including machine elements]; flexible tubes, not of metal, namely, flexible tubes consisting of artificial resins such as PVC and Plybutene for plumbing purposes, for use with ventilation systems, for use as connecting hoses in vehicles and industrial machines; junctions for pipes, not of metal; nonmetal gaskets for vehicles, not for vehicle engines; joint packings for sealing purposes, namely, joint packings for valves, cylinders, shafts, bearings, belts, straps, bands, and sliding and rotating joints and joint packings for pipes, namely, metal and plastic pipes for machines, and metal and plastic pipes for chemical plants; sealants for use in building, namely, adhesive sealants for use in construction; floating anti-pollution barriers; packaging containers of rubber; hydraulic hoses, not of metal, namely, hydraulic hoses of plastic and hydraulic hoses of rubber; semi-processed plastics; plastic sheets, namely, adhesive-coated plastic sheets; plastic sheets for use as interlayers for laminated glass; EVA (ethylene vinyl acetate) film for solar batteries; EVA (ethylene vinyl acetate) film for solar cells; urethane foam rubber; thermoplastic elastomers used as materials for buffers of HDD; flexible pipes and tubes of plastic for use in land vehicles, industrial machines, and buildings; flexible rubber tubes for use in land vehicles, industrial machines, and buildings; plastic sheets for use as adhesives in solar batteries, inserted between glasses and glasses, glasses and plastics, or plastics and plastics; rubber, namely, raw rubber and semi-worked rubber; synthetic rubber; natural rubber; rubber compounds, namely, rubber compound for use as an integral component of flexible pipes, tubes, and hoses not of metal, rubber tracks, and rubber compounds for the use in manufacture of tires; rubber material for retreading and repairing tires and repairing tubes; rubber material for recapping tires; seals, namely, sealing plugs made primarily from rubber and insulating seals made primarily from thermoplastic elastomer for use as automotive engine seals, non-metallic seals for preventing leakage of fluids, non-metallic seals for shock absorbers, pipe connection seals.

### **Class 18**

(8) Bags, namely, barrel bags, athletic bags, backpacks, duffle bags, book bags, sports bags, bum bags, wallets, handbags, camera bags, tool bags, all-purpose carrying bags, travel bags; pouches; shopping bags; bags for sports; rucksacks; travelling bags; handbags; wheeled shopping bags; net bags for shopping; purses; school bags; bags (envelopes, pouches) of leather for packaging; industrial packaging containers of leather; umbrellas; parasols; card cases; key cases (leatherware); vanity cases, not fitted.

### **Class 19**

(9) Rigid pipes, not of metal, for building, namely, rigid pipes for construction purposes consisting of artificial resin such as PVC and Polybutene; rubber building materials, namely, rubber flooring, rubber cove bases, rubber ceilings, rubber roof, rubber underground pipes and tanks, flexible

rubber pipes; building stone; antiseismic construction materials, not of metal; rubber bearings for seismic isolation of buildings; rubber building materials for seismic isolation, namely, rubber bearings for seismic isolation of buildings; non-metallic building materials, namely, non-metal ceiling panels, non-metal door casings, non-metal door frames, non-metal drain pipes, non-metallic roof flashing, non-metal roofing incorporating solar cells, non-metal stairs, and non-metallic paving tiles and paving slabs; roofing waterproof membranes; rubber covered non-metal chains for preventing bridge collapse; man-made garden ponds (structures, not of metal).

### **Class 20**

(10) Industrial water storage tanks of plastic; valves of plastic, other than machine parts, namely, water-pipe valves of plastic; tanks, not of metal nor of masonry, namely, polyethylene liquid storage tanks for industrial purposes; chests, not of metal, namely, furniture chests; desks; chairs; mirrors; bathroom vanities (furniture); bookcases; cushions; Japanese floor cushions [zabuton]; pillows; mattresses; cases of wood, namely, display cases; bamboo and plastic containers for packaging; fans for personal use, non-electric; water tanks for household purposes not of metal or masonry; hairdresser's chairs.

### **Class 24**

(11) Towels of textile; handkerchiefs; labels (cloth); sleeping bags for camping.

### **Class 25**

(12) Clothing for sports; sports footwear; wind jackets; wristbands; golf shoes; golf spikes; spiked golf shoes; cyclist's suits of jerseys for racing; cyclist's pants for racing; cyclist's overalls; clothing; golf trousers; golf caps; golf shirts; golf pants; golf skirts; jackets; jogging pants; sweat pants; trousers; overcoats; raincoats; sweaters; sport shirts; camisoles; shirts; undershirts; underpants; thermal underwear; vests; open-necked shirts; polo shirts; neck scarves [mufflers]; socks; scarfs; gloves; gloves for bicycling; neckerchieves; thermal supporters [clothing]; fur muffs; ear muffs; hats; caps (clothing); visors; sports shoes; walking shoes; shoes; casual footwear; Japanese style coats [happi]; aprons; gloves for bicycle racing; gloves for cycling.

### **Class 28**

(13) Home video game machines; toys, namely, toy models, Puppets, model toy vehicles, ride-on toys, toy scooters, water toys, toy tools, toy cars, toy construction sets, inflatable pool toys, pet toys, soft sculpture toys, toy robots, toy drones, radio-controlled toys; dolls; miniature cars; four-wheeled toy vehicles; rubber balls; tricycles for infants; model vehicles; golf clubs; golf bags; golf balls; golf gloves; golf club heads; golf club head covers; golf irons; golf putters; golf equipment, namely, golf training equipment, namely, motorized golf chipping practice aid, golf training cage; sports bags shaped to contain specific sports apparatus; tennis rackets; tennis balls

## **Services**

### **Class 35**

(1) Retail and wholesale store services featuring automobile accessories, tires and parts and fittings for automobiles, sporting goods, bicycles and parts and fittings for bicycles; subscription management services provided in relation to hire, leasing, rental, replacement, repair, inspection, maintenance, monitoring, management and hire purchase of tires and vehicle parts; information, advice and consultancy provided in relation to subscription management services provided in relation to hire, leasing, rental, replacement, repair, inspection, maintenance, monitoring, management and hire purchase of tires and vehicle parts; inventory and order management services relating to tires; computerized database management in relation to tracking, locating and monitoring vehicles, or tires; business management services, namely managing fleet of commercial motor vehicles, vehicle performance, and workforce; business consulting services

relating to operations management services, logistics, transportation and distribution solutions, vehicle maintenance, and optimised driving costs.

### **Class 37**

(2) Repair and maintenance of automobiles and their parts, and information, advice and consultancy provided in relation to all the aforesaid services; repair and maintenance of tires for automobiles, and information, advice and consultancy provided in relation to all the aforesaid services; retreading of tires, and information, advice and consultancy provided in relation to all the aforesaid services; repair and maintenance of two-wheeled motor vehicles and their parts, and information, advice and consultancy provided in relation to all the aforesaid services; repair and maintenance of tires for two-wheeled motor vehicles, and information, advice and consultancy provided in relation to all the aforesaid services; repair and maintenance of bicycles and their parts, and information, advice and consultancy provided in relation to all the aforesaid services; repair and maintenance of tires for bicycles, and information, advice and consultancy provided in relation to all the aforesaid services; repair and maintenance of tires for aircraft, and information, advice and consultancy provided in relation to all the aforesaid services; aircraft repair and maintenance, and information, advice and consultancy provided in relation to all the aforesaid services; tire repair and recapping services, and information, advice and consultancy provided in relation to all the aforesaid services; roofing services, and information, advice and consultancy provided in relation to all the aforesaid services; construction, and information, advice and consultancy provided in relation to all the aforesaid services; roof repair, and information, advice and consultancy provided in relation to all the aforesaid services; roof installation, and information, advice and consultancy provided in relation to all the aforesaid services; installation, maintenance and repair of telematics and navigation apparatus for vehicles, namely, wireless Internet-enabled devices in the nature of on-board computers, GPS receivers and GPS transmitters that provide telematics services and have cellular phone function and transmit vehicle data, messages and information, namely, information about vehicle maintenance and tire pressure and tire temperature, and information, advice and consultancy provided in relation to all the aforesaid services; installation, maintenance and repair of apparatus for locating vehicles, anti-theft equipment for vehicles, electronic navigation and tracking apparatus for use in vehicles, and information, advice and consultancy provided in relation to all the aforesaid services; inspection of tires and vehicles prior to maintenance and repair, and information, advice and consultancy provided in relation to all the aforesaid services; providing information on tire pressure and tire temperature for maintenance of vehicle tires via telecommunication networks; providing information about tire maintenance, tire retreading and usage of tires to consumers, tire dealers, service providers and fleet managers; tire retreading, namely, retreading tires, and providing advice, repair and maintenance information in the field of retreading tires; consultancy, information and inspection services relating to repair and maintenance of tires and vehicles; consultancy, information and inspection services relating to retread of tires; consultancy, information, advice and inspection services relating to tire maintenance to prevent tire deflection, driving risk and safe driving of vehicles; inspection of tires and vehicles prior to maintenance and repair retreading of tires; maintenance, installation and replacement services provided in relation to tires and vehicle parts; repair, inspection prior to potential maintenance and repair, installation, replacement, maintenance of aircraft, namely, tires for aircraft and wheels for aircraft, and information, advice and consultancy services relating to the aforesaid services.

### **Class 39**

(3) Transport, namely, transport of goods and passengers by air, rail, ship, bus, tram and truck, and information, advice and consultancy provided in relation to all the aforesaid services; tracking and tracing of vehicles in transit, all of the aforesaid services also provided via a global computer



network, cellular telephone communication and wireless in-vehicle navigation system, and information, advice and consultancy provided in relation to all the aforesaid services; providing of navigation and information services, namely information relating to traffic, road conditions and traffic jams, all of the aforesaid services also provided via a global computer network, cellular telephone communication and wireless in-vehicle navigation system, and information, advice and consultancy provided in relation to all the aforesaid services; provision of information relating to travel, all of the aforesaid services also provided via a global computer network, cellular telephone communication and wireless in-vehicle navigation system, and information, advice and consultancy provided in relation to all the aforesaid services; consultancy relating to traffic, journeys and roadworks, namely monitoring traffic and receiving alerts from vehicles, all of the aforesaid services also provided via a global computer network, cellular telephone communication and wireless in-vehicle navigation system, and information, advice and consultancy provided in relation to all the aforesaid services; logistics and fleet management in the field of tracking, locating and monitoring vehicles, all the aforesaid services also provided via a global computer network, cellular telephone communication and wireless in-vehicle navigation system, and information, advice and consultancy provided in relation to all the aforesaid services; rental of tires and vehicle parts and information, advice and consultancy provided in relation to all the aforesaid services; advisory services relating to the storage of tires; providing electronic tracking services of tires to others for business management and inventory purposes.

#### **Class 41**

(4) Arranging and conducting of swimming classes for handicapped people; arranging and conducting of wheelchair tennis classes; arranging and conducting of exercise programs (training for prevention of frailty and walking assistance); arranging and conducting of educational and cultural classes in the fields of music, dance, art, namely art exhibitions, art instruction, cooking, technical writing, photography, drama, motor vehicle safety, data security systems, quality, design and methods of repair, ageing, life longevity of motor vehicles, real estate, namely, arranging and conducting real estate conferences, financial affairs, namely, arranging and conducting financial conferences, electronic commerce, retail, entertainment in the form of automobile races, comedy shows, dance performances, live musical concerts, television shows, sports, namely, sports instruction in the fields of triathlon, cycling, running, golf, tennis, marathon, swimming, basketball, volleyball, baseball, American football, rugby, ice hockey, football, judo, wrestling, and boccia, research and development in the fields of rubber, tires, motor vehicles, rubber tracks, conveyer belts, bicycles, sports equipment, namely, golf equipment, tennis equipment, and cycling equipment, hoses for industrial machines, and seismic isolators for building, cultural affairs, arts and crafts, social fields; arranging and conducting of universal sports events, namely, triathlon, cycling, running, golf, tennis, marathon, swimming, basketball, volleyball, baseball, American football, rugby, ice hockey, football, judo, wrestling, boccia.

#### **Class 42**

(5) Consultancy in the field of computer software design; development and design of navigation systems and route planners; computer software and hardware design; development and design of computer software for use with navigation systems and route planners and with electronic maps and digital dictionaries; development and design of wireless computer networks; software as a service [SaaS] featuring software for tracking and monitoring in the field of fleet management; design of software for compiling and recovering information on the location of vehicles, route reconstruction, driver activities; preparation, update, installation and maintenance of computer software; creation of databases on traffic and information relating to travel; design and testing of new products for others; design, maintenance and development of computer software for use in relation to the replacement, repair, inspection, installation, monitoring, management, maintenance,

leasing, ordering, purchase or hire purchase of tires, vehicle parts, vehicles and groups of vehicles; quality control services, namely monitoring, checking and testing status of tires, vehicle parts, vehicles and groups of vehicles; technological analysis and consulting services related to the selection, condition, maintenance, retreading or replacement of vehicle tires; technological analysis and consulting services related to the selection, condition, maintenance or replacement of vehicle component parts, spare parts and accessories; providing an online platform for managing information and data associated with tires, vehicle parts, vehicles and groups of vehicles; provision of technological reports and information in relation to tires, vehicle parts, vehicles and groups of vehicles; provision of technological notifications and technological reports concerning tires, vehicle parts, vehicles and groups of vehicles; technical support and consultancy in the form of monitoring global computer network systems; secure or non-secure storage services of digital data, namely the electronic storage of digital data, photographs, audio files, data, information and image signals, all in particular for navigation systems, route planners and the use of electronic maps; inspection services provided in relation to tires; technical data analysis of vehicles and vehicle components, namely, tires, brakes, batteries, engine oils and default signals; technical data analysis of bicycles and bicycle components, namely, tires, brakes, batteries and default signals; analysis of research data and statistics relating to vehicles and vehicle components, namely, tires, brakes, batteries, engine oils and default signals; analysis of research data and statistics relating to bicycles and bicycle components, namely, tires, brakes, batteries and default signals; providing technological information, consultancy and advice in relation to vehicles and vehicle components, namely, tires, brakes, batteries, engine oils and default signals; providing technological information, consultancy and advice in relation to bicycles and bicycle components, namely, tires, brakes, batteries and default signals; providing technological information, consultancy and advice in relation to course of action to solve problem of vehicles and vehicle components, namely, tires, brakes, batteries, engine oils and default signals; providing technological information, consultancy and advice in relation to course of action to solve problem of bicycles and bicycle components, namely, tires, brakes, batteries and default signals; technological consultancy, information, advice and inspection services relating to usage to prevent tire deflection, driving risk and safe driving of vehicles.

(6) Inspection services provided in relation to vehicle parts.

#### **Class 43**

(7) Cafeteria services.

#### **Class 44**

(8) Health consultancy, namely, public health counselling, consultancy relating to nutrition, health spa services for health and wellness of the body and spirit, health care consultancy in the field of occupational therapy, health risk assessment, food and nutrition consultation services, medical consultancy for selecting appropriate wheelchairs, commodes, invalid hoists, walking frames and beds, professional consultancy in the field of medical technology, medical surgery and orthopaedics.

#### **Claims**

Priority Filing Date: December 03, 2019, Country or Office: JAPAN, Application No: 2019-152041 in association with the same kind of goods and in association with the same kind of services (1), (2), (3), (4), (5), (7), (8); February 10, 2020, Country or Office: JAPAN, Application No: 2020-014335 in association with the same kind of services (6)

**Application Number** 2,050,575  
**International Registration Number** 1549163  
**Language of Application** English

**Filing Date** 2020-05-29

## APPLICANT AND AGENT DETAILS

### Applicant

FINVIZ s. r. o.  
Hrusovská 29  
SK-821 07 Bratislava  
SLOVAKIA

### Agent

AVENTUM IP LAW LLP  
Suite 104, Tower A, 555 Legget Drive, Ottawa,  
ONTARIO, K2K2X3

## TRADEMARK DETAILS

# FINVIS

### Trademark Type

Standard Characters

### Services

#### Class 36

Insurance underwriting; computer analyses of stock exchange information; financial investment analysis and stock research; organization of stock exchanges for the benefit of the trade of stocks and other financial values; providing information, ratings, reviews and recommendations relating to stocks via a web site; providing stock market information; stock exchange information services

**Application Number** 2,051,424  
**Language of Application** English

**Filing Date** 2020-09-14

## APPLICANT AND AGENT DETAILS

**Applicant**

Yves Saint Laurent Parfums  
37-39 rue de Bellechasse  
Paris, 75007,  
FRANCE

**Agent**

FASKEN MARTINEAU DUMOULIN LLP  
Tour de la Bourse, Suite 3500, P.O. box 242,  
800, Place Victoria, Montréal, QUEBEC,  
H4Z1E9

## TRADEMARK DETAILS

**Trademark Type**

Design

**Visual Representation**

ROUGE  
VELOURS

PATCHOULI - ROSE

YVES SAINT LAURENT

**Goods****Class 03**

Perfumed soaps; perfumes; eau de cologne; toilet waters; eau de parfum; personal deodorants; cleansing and fragancing milks and creams for cosmetic purposes; scented body lotions and creams; essential oils for personal use.

**Claims**

Priority Filing Date: April 17, 2020, Country or Office: FRANCE, Application No: 4640071 in association with the same kind of goods

**Application Number** 2,051,687  
**Language of Application** English

**Filing Date** 2020-09-15

## APPLICANT AND AGENT DETAILS

### Applicant

Gemterra Developments Corporation  
7755 Warden Avenue, Unit 6  
Markham  
ONTARIO  
L3R0N3

### Agent

GOWLING WLG (CANADA) LLP  
SUITE 1600, 1 FIRST CANADIAN PLACE, 100  
KING STREET WEST, TORONTO, ONTARIO,  
M5X1G5

## TRADEMARK DETAILS

### Trademark Type

Design

### Visual Representation



RENŪ  
MY CONDO

The image shows the trademark 'RENŪ MY CONDO' in a bold, sans-serif font. The word 'RENŪ' is significantly larger than 'MY CONDO'. The letter 'Ū' in 'RENŪ' has a horizontal bar above it, resembling a macron. The text is centered and appears to be a watermark or a faded version of the trademark.

### Services

#### Class 37

Construction and renovation of buildings; home renovation; house building and repair; providing information in the field of home renovations via a website; renovation of buildings

**Application Number** 2,051,744  
**Language of Application** English

**Filing Date** 2020-09-15

## APPLICANT DETAILS

### Applicant

sudhir anand  
7015 Tranmere Dr  
unit 16  
Mississauga  
ONTARIO  
L5S1T7

## TRADEMARK DETAILS

# Voice News Network Canada

### Trademark Type

Standard Characters

### Services

#### Class 35

advertising the goods and services of others via electronic media and specifically the internet; media relations services; providing business information in the field of social media; providing marketing consultancy in the field of social media; providing marketing consulting in the field of social media; social media strategy consulting

**Application Number** 2,052,150  
**International Registration Number** 1550613  
**Language of Application** English

**Filing Date** 2020-07-22

## APPLICANT AND AGENT DETAILS

### Applicant

Della Vite Trading Limited  
C/O Osborne Clark,  
One London Wall  
London EC2Y 5EB  
UNITED KINGDOM

### Agent

GOWLING WLG (CANADA) LLP  
SUITE 1600, 1 FIRST CANADIAN PLACE, 100  
KING STREET WEST, TORONTO, ONTARIO,  
M5X1G5

## TRADEMARK DETAILS

### Trademark Type

Design

### Visual Representation



### Goods

#### Class 25

(2) Clothing namely casual clothing, athletic clothing, dress clothing, t-shirts, headgear namely hats, toques, headbands, caps.



**Class 33**

(1) Wines, sparkling wines and alcoholic beverages namely sparkling wine cocktails, dessert wines, fortified wines, low alcohol wine, rosé wine, wine-based beverages.

**Claims**

Priority Filing Date: January 22, 2020, Country or Office: UNITED KINGDOM, Application No: UK00003460240 in association with the same kind of goods (1); July 22, 2020, Country or Office: UNITED KINGDOM, Application No: UK00003514475 in association with the same kind of goods (2)

**Application Number** 2,052,155  
**International Registration Number** 1550114  
**Language of Application** English

**Filing Date** 2020-07-22

## APPLICANT AND AGENT DETAILS

### Applicant

Della Vite Trading Limited  
C/O Osborne Clark,  
One London Wall  
London EC2Y 5EB  
UNITED KINGDOM

### Agent

GOWLING WLG (CANADA) LLP  
SUITE 1600, 1 FIRST CANADIAN PLACE, 100  
KING STREET WEST, TORONTO, ONTARIO,  
M5X1G5

## TRADEMARK DETAILS

# DV

### Trademark Type

Standard Characters

### Goods

#### Class 33

Wines, sparkling wines and alcoholic beverages namely sparkling wine cocktails, dessert wines, fortified wines, low alcohol wine, rosé wine, wine-based beverages.

### Claims

Priority Filing Date: January 22, 2020, Country or Office: UNITED KINGDOM, Application No: UK00003460206 in association with the same kind of goods; July 22, 2020, Country or Office: UNITED KINGDOM, Application No: UK00003514487 in association with the same kind of goods

**Application Number** 2,053,159  
**Language of Application** English

**Filing Date** 2020-09-23

## APPLICANT AND AGENT DETAILS

### Applicant

FORD MOTOR COMPANY  
One American Road  
Dearborn, MI 48126  
UNITED STATES OF AMERICA

### Agent

DEETH WILLIAMS WALL LLP  
150 YORK STREET, SUITE 400, TORONTO,  
ONTARIO, M5H3S5

## TRADEMARK DETAILS

# LINCOLN NAUTILUS

### Trademark Type

Standard Characters

### Goods

#### Class 12

Passenger automobiles

### Claims

Registration will be subject to the provisions of Section 67(1) of the Trademarks Act, in view of Newfoundland Registration No 0955 in association with the same kind of goods.

**Application Number** 2,053,385  
**International Registration Number** 1551784  
**Language of Application** English

**Filing Date** 2020-04-08

## APPLICANT AND AGENT DETAILS

**Applicant**  
SAPRO TEMIZLIK ÜRÜNLERİ SANAYİ VE  
TİCARET ANONİM ŞİRKETİ  
Ortaköy Mahallesi,  
İlter Bulvarı, No:27  
TR-34582 Silivri - İstanbul  
TURKEY

**Agent**  
NEOMARK LTD.  
7450 rue Saint-Hubert, Montréal, QUEBEC,  
H2R2N3

## TRADEMARK DETAILS

**Trademark Type**  
Design

**Visual Representation**



**Colour Claim**

Colour is claimed as a feature of the trademark. The globe is in shades of blue with the continents in green. The leaf and the band around the globe is in green. The wording PLANET WIPES is in green and BY SAPRO is in black. The wavy band before the word SAPRO is in light blue.

**Disclaimer**

The right to the exclusive use of the word WIPES is disclaimed apart from the trademark.

**Goods****Class 03**

(1) Bleaching preparations for cosmetic purposes; bleaching preparations for the hair; bleaching salts; bleaching soda; leather bleaching preparations; all-purpose cleaning preparations; all-purpose cleaning preparations for smokers' articles; bathroom cleaning preparations; carpet cleaning preparations; cleaning fluids for camera lenses; cleaning fluids for spectacles; cleaning pads impregnated with cosmetics; cleaning preparations for automobile tires and wheels; cleaning preparations for cleansing drains; cleaning preparations for dishes; cleaning preparations for leather; cleaning preparations for plant leaves; cleaning preparations for use in toilets; cleaning solution for oral vaporizers for smoking; cleaning solutions for dental ultrasonic sterilization apparatus; denture cleaning preparations; drain cleaning preparations; dry-cleaning preparations; floor cleaning preparations; glass cleaning preparations; hair cleaning preparations; hand cleaning preparations; non-medicated cleaning preparations for use on the body; tooth cleaning preparations; wallpaper cleaning preparations; windscreen cleaning preparations; windshield cleaning preparations; laundry bleach; fabric softeners for laundry use; fabric stain removers; laundry stain removers; dishwasher detergents; perfumery; cosmetics (except medicated cosmetics); fragrances; deodorants for personal use; deodorants for pets; almond soaps; body soaps; buriti-based soaps; copaiba-based soaps; cosmetic soaps; cream soaps; facial soaps; granulated soaps; hemp-based deodorant soaps; liquid bath soaps; liquid hand soaps; liquid soaps for hands, face and body; liquid soaps used in foot baths; loofah soaps; non-medicated body soaps; non-medicated liquid soaps; non-medicated soaps for personal use; non-medicated toilet soaps; perfumed toilet soaps; scented soaps; shaving soaps; shower soaps; skin soaps; soaps for body care; soaps for household use; soaps for laundry use; soaps for personal use; soaps for saddlery; soaps for toilet purposes; stainless steel soaps; toilet soaps; anti-cavity dental rinses; dental bleaching gels; dental rinses; non-medicated toothpaste; swallowable toothpaste; toothpaste; tooth whitening gels; dentifrices; denture polishes; tooth whitening preparations; mouthwashes, not for medical purposes; abrasives for cleaning excess resins from grinding wheels; abrasives for preparing nail surfaces for nail polish; abrasives for re-surfacing materials before painting; general use abrasives; scouring solutions; silicon carbide abrasives; skin abrasives; emery cloth; sandpaper; pumice stone; abrasive pastes; tissues impregnated with cosmetic lotions; tissues impregnated with make-up removing preparations.

**Class 05**

(2) Radioactive pharmaceutical preparations for in vivo diagnostics or therapeutic use; acai powder dietary supplements; activated charcoal dietary supplements; albumin dietary supplements; alginate dietary supplements; amino acid dietary supplements; anti-oxidants for use as dietary

supplements; bee pollen used as a dietary supplement; brewer's yeast dietary supplements; casein dietary supplements; chlorella dietary supplements; colostrum dietary supplements; copaiba powder dietary supplement; dietary food supplements in the nature of ready-to-eat protein bars; dietary supplement drink mixes for general health and wellbeing; dietary supplements consisting of amino acids, minerals and trace elements; dietary supplements consisting of vitamins; dietary supplements consisting primarily of calcium; dietary supplements consisting primarily of iron; dietary supplements consisting primarily of magnesium; dietary supplements for body weight control; dietary supplements for controlling cholesterol; dietary supplements for general health and well-being; dietary supplements for promoting weight loss; flaxseed dietary supplements; flaxseed oil dietary supplements; folic acid dietary supplements; glucose dietary supplements for animals; guaraná powder dietary supplement; hemp-based dietary supplements; lecithin dietary supplements; linseed dietary supplements; linseed dietary supplements for animals; linseed oil dietary supplements; medicated beverages in the nature of dietary supplements for colon detoxification; medicated beverages in the nature of dietary supplements for liver detoxification; mineral dietary supplements for animals; mineral dietary supplements for humans; mugwort dietary supplements; natural dietary supplements for treating claustrophobia; nutraceutical dietary supplement for maintaining general health and wellbeing; pine pollen dietary supplements; pollen dietary supplements; probiotic dietary supplements; propolis dietary supplements; protein powder dietary supplements; protein powders for meal replacement for use as a dietary supplement; red wine powder dietary supplements; royal jelly dietary supplements; soy isoflavone dietary supplements; soy protein dietary supplements; spirulina dietary supplements; vitamin and mineral dietary supplements; wheat dietary supplements; wheat germ dietary supplements; wheatgrass dietary supplements; whey protein concentrates being dietary supplements; whey protein hydrolysates being dietary supplements; whey protein isolates being dietary supplements; whey proteins being dietary supplements; yeast dietary supplements; yeast dietary supplements for animals; zinc dietary supplements; mineral nutritional supplements; non-medicated nutritional supplements for animal feed; nutritional supplements consisting of vitamins and minerals; nutritional supplements for building body mass; nutritional supplements for foodstuffs for animals; nutritional supplements for general health and well-being; nutritional supplements for livestock feed; slimming capsules; slimming pills; slimming tea for medical purposes; transdermal patches for use in the treatment of weight loss; weight loss lozenges; food for babies; herbs and herbal based dietetic beverages for babies adapted for medical purposes; herbs and herbal based electrolyte replacement beverages for medical purposes; herbs and herbal based beverages adapted for medicinal purposes for general health and well-being; dental preparations for disclosing plaque; dental wax for the preparation of dental moulds; preparations to facilitate teething; dental materials for stopping the teeth; dental varnishes for sealing teeth; material for repairing teeth and for dental crowns and bridges; materials for artificial teeth; material for tooth crowns and tooth bridges for dental and dental technical purposes; materials for tooth restoration; teeth filling material; dental impression material; dental adhesives and material for repairing teeth; breast pads; feminine hygiene pads; incontinence pads; nursing pads; paper pads for changing diapers; reusable breast-nursing pads; hygienic tampons; adhesive plasters; anti-inflammatory analgesic plasters; corn plasters; dental plasters; gummed taffeta plasters; medical plasters; mustard plasters; plasters for medical purposes; sticking plasters; surgical plasters; bandages for dressings; dressings for burns; dressings for medical and veterinary purposes; dressings for wounds; first aid dressings; materials for dressing wounds; medical dressings; self-adhesive dressings; sterile burn dressings; sterile dressings; surgical dressings; transparent film dressings; wound dressings; diapers, including those made of paper and textiles; babies' diapers of paper; babies' diapers of textile; babies' napkins of paper; adult diapers of paper; adult diapers of textile; diapers for pets; preparations for destroying vermin; fungicides, herbicides; rodenticides; air

deodorants; bathroom deodorants; car deodorants; deodorants for clothing; deodorants for refrigerators; deodorants for textiles; deodorants for upholstery; room deodorants; toilet deodorants; air deodorising preparations; all-purpose disinfectants; contact lens disinfectants; disinfectants for chemical toilets; disinfectants for dental and medical apparatus and instruments; disinfectants for household purposes; disinfectants for swimming pools; kennel disinfectants; sulphur sticks as disinfectants; urinary tract disinfectants; antiseptics; detergents for medical purposes; medicated soap for the treatment of rosacea; medicated soaps for babies; disinfectant soap; antibacterial hand lotions.

### **Class 16**

(3) Paper and cardboard; paper and cardboard for packaging and wrapping purposes, cardboard boxes; paper towels; toilet paper; paper napkins; plastic materials for packaging and wrapping purposes; printing blocks and types; bookbinding material; art prints; printed advertising boards of cardboard; printed advertising boards of paper; printed awards; printed calendars; printed flip charts; printed invitations; printed material in the nature of color samples; printed menus; printed patterns for dressmaking; printed sheet music; printed tags; printed timetables; books; magazines; newspapers; bill books; printed dispatch notes; printed vouchers; calendars; posters; photographs [printed]; paintings; stickers [stationery]; postage stamps; paper stationery; stationery agendas; stationery binders; stationery cases; stationery labels; stationery pencil ornaments; stationery personal organizers; stationery seals; stationery stickers; stationery tabs; writing stationery; office stationery; writing and drawing implements; artists' brushes; artists' moulds; artists' palettes; artists' pastels; artists' pencils; artists' pens; artists' watercolour saucers; canvas stretcher bars for artists; paper products for stationery purposes; adhesives for stationery purposes; pens; pencils; erasers; adhesive tapes for stationery purposes; cardboard cartons [artists' materials]; writing paper; copying paper; paper rolls for cash registers; drawing materials; chalkboards; painting pencils; watercolors [paintings]; office binders; office glues; office hole punchers; office machine ribbons; office paper stationery; office perforators; office requisites in the form of finger-stalls; office rubber stamps; office supply binders; bookbinding machines for office use; clips for offices; elastic bands for offices; electric staplers for offices; envelope sealing machines for offices; staples for offices; paint rollers and paintbrushes for painting.

### **Claims**

Priority Filing Date: March 13, 2020, Country or Office: TURKEY, Application No: 2020/31868 in association with the same kind of goods

**Application Number** 2,053,718  
**International Registration Number** 1552390  
**Language of Application** English

**Filing Date** 2020-09-01

## APPLICANT AND AGENT DETAILS

### Applicant

HypnoBirthing, LLC  
110 Sheep Davis Rd Ste 2  
Pembroke NH 03275-3715  
UNITED STATES OF AMERICA

### Agent

ERIN MCEWEN  
NELLIGAN O'BRIEN PAYNE LLP , 50  
O'Connor Street, Suite 300, Ottawa,  
ONTARIO, K1P6L2

## TRADEMARK DETAILS

### Trademark Type

Design

### Visual Representation



HypnoBirthing  
INTERNATIONAL  
The Mongan Method

## Services

### Class 44

Hypnotherapy; therapy services, namely, holistic massage, bodywork therapy, meditation therapy, music therapy, respiratory therapy, physical therapy, psychological therapy; health counselling regarding the choice of medication, drug usage and information on side effects; alternative medical services in relation to labor and birthing, namely, hypnosis, mental relaxation and breathing techniques; medical consultancy and advisory services in relation to labor and birthing; providing information about medical services in relation to labor and birthing, namely, hypnosis, mental relaxation and breathing techniques, online and in person

## Claims

Priority Filing Date: March 02, 2020, Country or Office: AUSTRALIA, Application No: 2072750 in association with the same kind of services



**Application Number** 2,054,438  
**Language of Application** English

**Filing Date** 2020-09-28

## APPLICANT AND AGENT DETAILS

### Applicant

Future Motion, Inc.  
1201 Shaffer Road  
Santa Cruz, CA 95060  
UNITED STATES OF AMERICA

### Agent

GOWLING WLG (CANADA) LLP  
550 BARRARD STREET, SUITE 2300,  
VANCOUVER, BRITISH COLUMBIA, V6C2B5

## TRADEMARK DETAILS

### Trademark Type

Design

### Visual Representation



### Goods

#### Class 09

(1) Chargers for electric batteries, namely, chargers for batteries for electronically motorized skateboards and self-propelled electrically powered motor vehicles; battery chargers for electronically motorized skateboards and self-propelled electric vehicles; Bags specially adapted to carry chargers for electric batteries and battery chargers for electronically motorized skateboards and self-propelled electric vehicles; Protective sports helmets

#### Class 12

(2) Vehicles, namely, electronically motorized skateboards; Land vehicle parts, namely, fenders; Bags specially adapted to carry electronically motorized skateboards and self-propelled electrically powered motor vehicles; footpads for electronically motorized skateboards; Vehicle bumpers; metal stands for holding stationary electronically motorized skateboards and self-propelled electric vehicles in an upright position; Holders specially adapted for holding electronically motorized skateboards and self-propelled electrically powered motor vehicles.

#### Class 25

(3) Hats; Beanies; Socks; T-shirts; Shirts

**Application Number** 2,055,463  
**Language of Application** English

**Filing Date** 2020-10-02

## **APPLICANT DETAILS**

### **Applicant**

Manne Hassan  
1405 Rosenthal ave  
Ottawa  
ONTARIO  
k1z8j1

## **TRADEMARK DETAILS**

### **Trademark Type**

Design

### **Visual Representation**



**Colour Claim**

Colour is claimed as a feature of the trademark. The colour white and yellow-gold is a feature of the trademark. The yellow-gold is used in the crescent moon and in the letters A,N,N,A, and Y. The colour white is used in the letter M and the in background of the logo.

**Goods****Class 25**

casual clothing; casual clothing featuring pants, dresses and shorts; coats for women; women's blouses; women's shoes; women's sportswear

**Application Number** 2,056,507  
**International Registration Number** 1554249  
**Language of Application** English

**Filing Date** 2020-08-28

## APPLICANT AND AGENT DETAILS

### Applicant

FLYING BLUE IMPORTS, LLC  
120 BISHOPS WAY, STE 124  
BROOKFIELD WI 53005  
UNITED STATES OF AMERICA

### Agent

AVENTUM IP LAW LLP  
Suite 104, Tower A, 555 Legget Drive, Ottawa,  
ONTARIO, K2K2X3

## TRADEMARK DETAILS

**french blue**

### Trademark Type

Standard Characters

### Goods

**Class 33**

Wine.

**Application Number** 2,056,535  
**International Registration Number** 1459218  
**Language of Application** English

**Filing Date** 2020-09-07

## APPLICANT AND AGENT DETAILS

### Applicant

F. DIVELLA S.P.A.  
Largo Domenico Divella n.1  
I-70018 Rutigliano (BA)  
ITALY

### Agent

PAUL B. BÉLANGER  
4360 av de Hampton, MONTRÉAL, QUEBEC,  
H4A2L2

## TRADEMARK DETAILS

# OTTIMINI

### Trademark Type

Standard Characters

### Goods

#### Class 30

Flour and preparations made from cereals, namely, biscuits, chocolate stuffed biscuits, cookies, chocolate stuffed cookies, bread, pastry and confectionery, namely, hazelnuts confectionery, fruits confectionery, fruit based confectionery, almonds confectionery, puffed rice and corn confectionery, whole wheat confectionery, chocolate confectionery, chocolate stuffed confectionery, whole wheat and chocolate chips confectionery, buckwheat confectionery, 7 cereals confectionery.

**Application Number** 2,057,057  
**Language of Application** English

**Filing Date** 2020-10-13

## APPLICANT AND AGENT DETAILS

### Applicant

Health and Happiness (H&H) Hong Kong Limited  
Suites 4007-09, 40th Floor, One Island east,  
Taikoo Place, 18 Westlands Road, Quarry Bay  
HONG KONG

### Agent

GOWLING WLG (CANADA) LLP  
SUITE 1600, 1 FIRST CANADIAN PLACE, 100  
KING STREET WEST, TORONTO, ONTARIO,  
M5X1G5

## TRADEMARK DETAILS

# KEEP YOUR BESTIE FEELING ZESTY

### Trademark Type

Standard Characters

### Goods

#### Class 03

(1) Pet shampoos; Shampoos for pets; Non-medicated, non-veterinary grooming preparations in the nature of pet shampoo and conditioner;

#### Class 05

(2) Dietary and nutritional supplements for pets for general health and wellbeing; Dietary and nutritional supplements for pets for maintaining a healthy digestive and immune system; Dietary and nutritional supplements for pets for heart health; Probiotic supplements for pets; Antioxidant supplements for pets; Hemp-based nutritional supplements for pets; dietary and nutritional supplements for pets, namely, vitamins; dietary and nutritional supplements for pets for relaxation and calmness; dietary and nutritional supplements for pets for skin health; dietary and nutritional supplements for pets for enhancing the immune system; Medicated anti-itch shampoos for pets; Veterinary preparations for the prevention and treatment of parasitic infections;

#### Class 31

(3) Pet food; edible pet treats

**Application Number** 2,057,992  
**Language of Application** English

**Filing Date** 2020-10-15

## APPLICANT AND AGENT DETAILS

### Applicant

Chris Stylianou Personal Real Estate  
Corporation  
5320 Moncton Street  
Richmond  
BRITISH COLUMBIA  
V7E3B3

### Agent

SMART & BIGGAR LP  
2300 - 1055 West Georgia Street, P.O. Box  
11115, Vancouver, BRITISH COLUMBIA,  
V6E3P3

## TRADEMARK DETAILS

# SREG

### Trademark Type

Standard Characters

### Services

#### Class 35

(1) advertising of commercial real estate for others; advertising of residential real estate for others; real estate advertising services for others; real estate marketing analysis services; real estate sales management services

#### Class 36

(2) acquisition of real estate for others; appraisal of real estate; appraisals for insurance claims of real estate; arranging of leases and rental agreements for real estate; assessment and management of real estate; evaluation of real property; financial valuation of personal property and real estate; leasing of real estate; real estate agencies; real estate appraisals; real estate brokerage; real estate brokers; real estate management; valuations in real estate matters

#### Class 37

(3) real estate development

#### Class 41

(4) arranging and conducting real estate conferences

**Application Number** 2,058,848  
**Language of Application** English

**Filing Date** 2020-10-21

## APPLICANT AND AGENT DETAILS

### Applicant

Utility Supply Corporation  
43 McBrine Place  
Kitchener  
ONTARIO  
N2R1E7

### Agent

SMART & BIGGAR LP  
SUITE 900, 55 METCALFE STREET, P.O.  
BOX 2999, STATION D, OTTAWA, ONTARIO,  
K1P5Y6

## TRADEMARK DETAILS

# MEGATITE

### Trademark Type

Standard Characters

### Goods

#### Class 06

(1) Pipes, pipe couplings, pipe connectors, pipe joints, branching pipes, pipe fittings, pipe valves, and pipe main stops, all of metal and all for municipal water pipe applications

#### Class 17

(2) Flexible plumbing pipes, pipe couplings, pipe joints, branching pipes, pipe fittings, and pipe main stops, all of plastic and all for municipal water pipe applications

#### Class 19

(3) Water pipes, pipe couplings, pipe connectors, pipe joints, branching pipes, pipe fittings, pipe valves, and pipe main stops, all of plastic and all for municipal water pipe applications



**Application Number** 2,058,971  
**International Registration Number** 1556471  
**Language of Application** English

**Filing Date** 2020-06-11

## APPLICANT AND AGENT DETAILS

### Applicant

Biamp Systems, LLC  
9300 SW Gemini Drive  
Beaverton OR 97008  
UNITED STATES OF AMERICA

### Agent

GOWLING WLG (CANADA) LLP  
SUITE 1600, 1 FIRST CANADIAN PLACE, 100  
KING STREET WEST, TORONTO, ONTARIO,  
M5X1G5

## TRADEMARK DETAILS

# MODENA

### Trademark Type

Standard Characters

### Goods

#### Class 09

Digital signal processors with a media system consisting of network server, computer network hub, computer hardware and software for signal amplifiers and signal processors used to capture, condition and transmit audio and video signals.

### Services

#### Class 38

Providing access to databases; providing information about telecommunications, namely, email transmission services, network conferencing, wireless electronic transmission of voice messages, streaming video, presentations, photographs and digital images for online meeting rooms and video conferencing over the internet and via wireless and cellular networks, providing electronic mail and instant messaging services, video conferencing services, multicamera video conferencing, web video conferencing services, teleconferencing services, voice over IP (VoIP) services, providing access to the Internet, operation of virtual rooms, operation of a wide-area network (WAN), operation of a local-area network (LAN); providing equipment for the electronic sending of messages, namely, the rental of modems, rental of microphones, leasing of computer networking equipment, rental of network conferencing equipment, and rental of video conferencing equipment; wireless broadcasting, namely providing streaming of audio and video featuring presentations, photographs and digital images for online meeting rooms and video conferencing; telecommunications routing and junction services, , namely, providing multiple user access to global computer information networks for the transfer and dissemination of a wide range of information; internet radio and television broadcasting; internet broadcasting namely providing streaming of audio and video featuring presentations, photographs and digital images for online meeting rooms and video conferencing

### Claims

Priority Filing Date: May 29, 2020, Country or Office: UNITED STATES OF AMERICA, Application No: 88939649 in association with the same kind of goods and in association with the same kind of services

**Application Number** 2,059,156  
**International Registration Number** 1556253  
**Language of Application** English

**Filing Date** 2020-09-02

## APPLICANT AND AGENT DETAILS

### Applicant

LA VIE EN ROSE, besloten vennootschap met  
beperkte aansprakelijkheid  
Golvenstraat 13  
B-8300 Knokke-Heist  
BELGIUM

### Agent

ERIN MCEWEN  
NELLIGAN O'BRIEN PAYNE LLP , 50  
O'Connor Street, Suite 300, Ottawa,  
ONTARIO, K1P6L2

## TRADEMARK DETAILS

# CUF

### Trademark Type

Standard Characters

### Goods

#### Class 14

Jewellery; ornaments being jewellery, namely, bracelets, bracelets for watches, bangles, rings, necklaces, chokers, pendants, earrings, pins, brooches; watches

**Application Number** 2,059,273  
**International Registration Number** 1556033  
**Language of Application** English

**Filing Date** 2020-09-17

## APPLICANT AND AGENT DETAILS

### Applicant

Bannix Group Pty Ltd  
52 Ivanhoe Parade  
Ivanhoe VIC 3079  
AUSTRALIA

### Agent

CASSAN MACLEAN IP AGENCY INC.  
190 O'CONNOR STREET, SUITE 710,  
OTTAWA, ONTARIO, K2P2R3

## TRADEMARK DETAILS

# CART SHARE

### Trademark Type

Standard Characters

### Services

#### Class 35

Retail department store services; retail convenience store services; retail grocery stores; online retail department store services; online retail convenience store services; online retail grocery stores; developing sales promotional campaigns for others; provision of an on-line marketplace for buyers and sellers of goods and services; retail sale of food and beverages, clothing, homewares, household cleaning articles, nutritional supplements, pharmaceuticals, entertainment electronics, books, downloadable and pre-recorded music, electronics, computer equipment, kitchenware, health supplements, beauty products, toys, games, footwear, luggage, bags, sports equipment, fitness equipment, automotive parts and accessories, pet accessories and pet foods; wholesale store services featuring food and beverages, clothing, homewares, household cleaning articles, nutritional supplements, pharmaceuticals, entertainment electronics, books, downloadable and pre-recorded music, electronics, computer equipment, kitchenware, health supplements, beauty products, toys, games, footwear, luggage, bags, sports equipment, fitness equipment, automotive parts and accessories, pet accessories and pet foods; organisation and management of customer loyalty programmes.

### Claims

Priority Filing Date: August 17, 2020, Country or Office: AUSTRALIA, Application No: 2110830 in association with the same kind of services

**Application Number** 2,060,706  
**International Registration Number** 1557469  
**Language of Application** English

**Filing Date** 2020-06-10

## APPLICANT AND AGENT DETAILS

### Applicant

Microsoft Corporation  
One Microsoft Way  
Redmond WA 98052-6399  
UNITED STATES OF AMERICA

### Agent

BERESKIN & PARR LLP/S.E.N.C.R.L., S.R.L.  
SCOTIA PLAZA, 40 KING STREET WEST,  
40th FLOOR, TORONTO, ONTARIO, M5H3Y2

## TRADEMARK DETAILS

# XBOX SERIES X

### Trademark Type

Standard Characters

### Goods

#### Class 09

(1) Computer games; video games; computer game software for use on personal computers and video game consoles; computer software for playing computer games and video games; computer software for use in providing multiple user access to a global computer information network; computers, computer hardware, batteries and battery chargers for notebook computers, battery chargers for laptop computers, battery chargers for tablet computers, computer cables, computer game discs, computer keyboards, computer mice, computer monitors, computer mouse mats, computer mouse pads, computer scanners; recorded video game programs; downloadable video game software.

#### Class 28

(2) Games, toys and playthings, namely, dolls, electronic action toys, molded toy figures, toy action figures, model toys, stuffed and plush toys, and accessories and playsets thereof; video game apparatus; video games consoles; video game consoles for use with an external display screen or monitor; controllers for game consoles; game controllers in the nature of keyboards for computer games; video game interactive remote control units.

### Services

#### Class 41

(1) Educational services, namely, providing educational information on online educational video games; providing of training in the fields of the video and computer game industries, general video game and computer game information, and video and computer game hardware, software and accessories; entertainment services, namely, providing online video games; organizing community sporting events and esports competitions.

#### Class 42

(2) Providing temporary use of non-downloadable game software; providing online non-downloadable game software.

### Claims

Priority Filing Date: December 11, 2019, Country or Office: LESOTHO, Application No: LS/M/2019 /00383 in association with the same kind of goods and in association with the same kind of services

**Application Number** 2,060,730  
**International Registration Number** 1557572  
**Language of Application** English

**Filing Date** 2020-07-01

## APPLICANT AND AGENT DETAILS

### Applicant

GRANITIFIANDRE S.p.A.  
Via Radici Nord, 112  
CASTELLARANO (RE)  
ITALY

### Agent

BCF S.E.N.C.R.L./BCF LLP  
1100, boul. René-Lévesque Ouest, 25e Étage,  
Montréal, QUEBEC, H3B5C9

## TRADEMARK DETAILS

### Trademark Type

Design

### Visual Representation



### Colour Claim

Colour is claimed as a feature of the trademark. The mark consists of the word "SURFACES" in black above the word "ACTIVE" in black, with a green stylized person inside of and forming part of the letter "A" in "ACTIVE".

### Goods

#### Class 19

ceramic and porcelain tiles

### Claims

Priority Filing Date: June 12, 2020, Country or Office: ITALY, Application No: 302020000046114 in association with the same kind of goods

**Application Number** 2,060,811  
**International Registration Number** 1558158  
**Language of Application** French

**Filing Date** 2020-08-14

## APPLICANT AND AGENT DETAILS

### Applicant

AARDEX GROUP Société anonyme  
Rue Bois Saint-Jean 15/1  
Seraing  
B-4102  
BELGIQUE

### Agent

BENOÎT & CÔTÉ INC.  
560 boul. Crémazie Est, 3e étage, Montréal,  
QUÉBEC, H2P1E8

## TRADEMARK DETAILS

# MEMS AS

### Trademark Type

Standard Characters

### Goods

#### Class 09

Scientific apparatus and instruments, namely recorders for timestamping related to medication intake and adherence to medication; apparatus for recording and processing information, namely recorders for timestamping related to medication intake and adherence to medication; apparatus and instruments for measuring and checking (supervision), for scientific use, namely recorders for timestamping related to medication intake and adherence to medication; data processing equipment, namely recorders for timestamping related to medication intake and adherence to medication; apparatus for recording, transmitting, processing and reproducing data, namely recorders for timestamping related to medication intake and adherence to medication; apparatus, namely computers and computer hardware for processing, transmitting and storing information in databases; apparatus for recording the time and date, namely recorders for timestamping related to medication intake and adherence to medication; downloadable software applications intended for use on mobile devices for measuring and monitoring adherence to medication and patients' compliance to medication plans; downloadable applications for mobile devices intended for managing and monitoring adherence to medication and patients' compliance to medication plans; memory units, namely microprocessors and microprocessor cards, intended for use with data processing apparatus; display screens, namely LCD screens; electronic data recorders for measuring, monitoring and managing adherence to medication and assisting patients to improve their adherence to medication; downloadable software, namely software for measuring and monitoring adherence to medication and patients' compliance to medication plans; downloadable compiler software; downloadable database management software; downloadable electronic publications, namely books, magazines and brochures in the field of adherence to medication; computer systems for processing medical data; downloadable software for cloud computing, namely software for managing and monitoring adherence to medication and patients' compliance to medication plans.

### Services

#### Class 42

Scientific and technological services, namely measuring and monitoring adherence to medication and patients' compliance to medication plans in the field of compliance with instructions related to health care; research and design services for measuring and monitoring adherence to medication and patients' compliance to medication plans in the field of compliance with instructions related to health care; design and development of downloadable software for measuring and monitoring adherence to medication and patients' compliance to medication plans; scientific evaluations, estimates, research and reports, related to measuring and monitoring adherence to medication and patients' compliance to medication plans in the field of compliance with instructions related to health care; technological and computer services related to the securing of computer data and personal and financial information and related to the detection of unauthorized access to data and information; scientific research services in the field of compliance with instructions related to health care; design, development, rental and programming of operating system software for access to a cloud computing network and its use; digital compression of computer data; design of computer databases; design, development, maintenance and updating of data processing software; design and development of medical software technologies in the field of compliance with instructions related to health care; development of data processing software; quality assessment of pharmaceutical preparations; research and development for the pharmaceutical industry.

**Claims**

Priority Filing Date: May 06, 2020, Country or Office: Benelux Office for IP (BOIP), Application No: 1416269 in association with the same kind of goods and in association with the same kind of services



**Application Number** 2,060,933  
**International Registration Number** 1558365  
**Language of Application** English

**Filing Date** 2020-09-16

## APPLICANT AND AGENT DETAILS

**Applicant**  
UBIQUITI INC.  
685 THIRD AVENUE, 27TH FLOOR  
NEW YORK NY 10017  
UNITED STATES OF AMERICA

**Agent**  
OSLER, HOSKIN & HARCOURT LLP  
Suite 320, World Exchange Plaza, 100 Queen  
Street, Ottawa, ONTARIO, K1P1J9

## TRADEMARK DETAILS

# CLOUD KEY

**Trademark Type**  
Standard Characters

### Goods

#### Class 09

Computer networking hardware; telecommunications base station equipment for cellular and fixed networking and wireless communications, data networking hardware containing network security functionality, namely, firewalls, data encryption, and interoperability with network security protocols, computer network servers, switches and routers and backup drives; downloadable software for administration of computer networks.

### Claims

Priority Filing Date: March 18, 2020, Country or Office: UNITED STATES OF AMERICA,  
Application No: 88839307 in association with the same kind of goods

**Application Number** 2,060,942  
**International Registration Number** 1558136  
**Language of Application** English

**Filing Date** 2020-09-16

## APPLICANT AND AGENT DETAILS

**Applicant**  
UBIQUITI INC.  
685 THIRD AVENUE, 27TH FLOOR  
NEW YORK NY 10017  
UNITED STATES OF AMERICA

**Agent**  
OSLER, HOSKIN & HARCOURT LLP  
Suite 320, World Exchange Plaza, 100 Queen  
Street, Ottawa, ONTARIO, K1P1J9

## TRADEMARK DETAILS

# LTU

**Trademark Type**  
Standard Characters

**Goods**

**Class 09**

Computer networking hardware; telecommunications base station equipment and antennae for cellular and fixed networking and wireless communications, data networking hardware containing network security functionality, namely, firewalls, data encryption, and interoperability with network security protocols, computer network servers, switches and routers and backup drives, computer hardware for transporting and aggregating voice, data and video communications across multiple network infrastructures and communications protocols; network access server hardware; downloadable computer networking software for wireless communications and connectivity, namely for managing and connecting users on wireless networks; electronic encoders and decoders for encoding and decoding audio and video signals in digital form for delivery to users via wireless networks; wireless radio transmitters and receivers.

**Claims**

Priority Filing Date: March 18, 2020, Country or Office: UNITED STATES OF AMERICA,  
Application No: 88839313 in association with the same kind of goods

**Application Number** 2,061,018  
**International Registration Number** 1557894  
**Language of Application** English

**Filing Date** 2020-09-23

## APPLICANT AND AGENT DETAILS

### Applicant

Sensitive Home, Inc.  
336 Bon Air Center #515  
Greenbrae CA 94904  
UNITED STATES OF AMERICA

### Agent

ROBIC  
630, boul. René-Lévesque Ouest, 20e étage,  
Montréal, QUEBEC, H3B1S6

## TRADEMARK DETAILS

# SENSITIVE HOME

### Trademark Type

Standard Characters

### Goods

#### Class 03

(1) All-purpose cleaners; glass cleaners; spray cleaners for household purposes; baby wipes impregnated with cleaning preparations; all purpose cleaning preparations; all purpose cleaning and washing preparations; cleaning foams, namely, foam detergents for household purposes, foam hand soaps; all purpose cleaning, polishing, degreasing and abrasive preparations for household purposes; floor cleaning preparations; general purpose cleaning, polishing and abrasive liquids and powders for floors, carpets, stainless steel surfaces, and toilet bowls; hair care and cleaning preparations; household cleaning preparations, namely, detergents, soaps, dish washing detergents; essential oils for household cleaning purposes; pre-moistened wipes with cleaning preparations for household purposes; preparations for the cleaning, care and grooming of hair; laundry detergents; laundry bleaching preparations; laundry fabric softeners; laundry stain removal preparations; skin care preparations; fragrances and perfumery; fragrances for household purposes; baby lotions; baby oils; baby shampoos; baby wipes; sanitary preparations being non-medicated toiletries, namely, personal deodorants; antiperspirants and deodorants for personal use; deodorants for pets.

#### Class 05

(2) Antibacterial cleaners, namely, antibacterial soaps, antibacterial detergents, antibacterial handwashes, medicated antibacterial facial washes; disinfectant bathroom cleaners; disinfectant toilet bowl cleaners; air deodorants; household deodorants; room deodorants; disinfectants for household use; disinfectants for hygiene purposes, namely, disinfecting hand wash.

### Claims

Priority Filing Date: March 31, 2020, Country or Office: NEW ZEALAND, Application No: 1144406 in association with the same kind of goods

**Application Number** 2,061,060  
**International Registration Number** 1558429  
**Language of Application** English

**Filing Date** 2020-09-29

## APPLICANT AND AGENT DETAILS

### Applicant

SOCIETA' AGRICOLA CASA PIETRAIA DI  
MATTEO NUTINI & C. S.S.  
Via San Donnino, 229  
I-50052 CERTALDO (FIRENZE)  
ITALY

### Agent

PERLEY-ROBERTSON, HILL & MCDUGALL  
LLP  
1400 - 340 ALBERT STREET, OTTAWA,  
ONTARIO, K1R0A5

## TRADEMARK DETAILS

### Trademark Type

Design

### Visual Representation



**Colour Claim**

Colour is claimed as a feature of the trademark. Colour green is claimed for the grass and trees. Colour brown is claimed for the snail. Colour yellow is claimed for the sun. Colour red is claimed for the sky. Colour black is claimed for the words "CASA PIETRAIA".

### **Foreign Character Translation**

The translation provided by the applicant of the word(s) CASA PIETRAIA is STONY GROUND HOME.

### **Goods**

#### **Class 29**

(1) Organic processed vegetables; vegetables, preserved; extra virgin olive oil for food; olive oils for food; oils for food, namely, edible oils; olives, preserved; olive pastes; marmalades; jellies, jams, compotes; fruit spreads; vegetable-based spreads.

#### **Class 30**

(2) Savory sauces used as condiments, namely, gravy sauce, meat sauce and tomato sauce; pasta sauce; honey.

### **Claims**

Priority Filing Date: May 25, 2020, Country or Office: EUIPO (EU), Application No: 018243895 in association with the same kind of goods

**Application Number** 2,061,214  
**Language of Application** English

**Filing Date** 2020-10-30

## **APPLICANT DETAILS**

**Applicant**  
9829113 CANADA INC.  
25-120 Vineberg Dr  
Hamilton  
ONTARIO  
L8W0B5

## **TRADEMARK DETAILS**

**tasshz**

**Trademark Type**  
Standard Characters

### **Goods**

#### **Class 09**

(1) battery chargers for cell phones; battery chargers for cellular phones; battery chargers for laptop computers; battery chargers for smartphones; car broadcasting tuners

#### **Class 14**

(2) jewellery and imitation jewellery

#### **Class 24**

(3) cloth towels; cotton towels

**Application Number** 2,061,323  
**Language of Application** English

**Filing Date** 2020-11-02

## APPLICANT AND AGENT DETAILS

### Applicant

Revise Consulting Ltd.  
19125-87a Ave.  
Surrey  
BRITISH COLUMBIA  
V4N6E4

### Agent

NEXUS LAW GROUP LLP  
777 Hornby Street, Suite 2000, Vancouver,  
BRITISH COLUMBIA, V6Z1S4

## TRADEMARK DETAILS

# UNICORN HUNTER

**Trademark Type**  
Standard Characters

### Goods

**Class 05**  
medicinal cannabis

**Application Number** 2,061,827  
**Language of Application** English

**Filing Date** 2020-11-04

## APPLICANT AND AGENT DETAILS

### Applicant

Allogene Therapeutics, Inc.  
210 E. Grand Avenue  
South San Francisco, CA 94080  
UNITED STATES OF AMERICA

### Agent

CLARK WILSON LLP  
900 - 885 WEST GEORGIA STREET,  
VANCOUVER, BRITISH COLUMBIA, V6C3H1

## TRADEMARK DETAILS

# ITURBOCAR

### Trademark Type

Standard Characters

### Goods

#### Class 05

Pharmaceutical preparations, namely, preparations for use in the treatment of cancer and tumors; pharmaceutical and biological preparations for immunotherapy, including T Cell therapy

### Claims

Priority Filing Date: May 08, 2020, Country or Office: UNITED STATES OF AMERICA, Application No: 88906315 in association with the same kind of goods



**Application Number** 2,061,828  
**Language of Application** English

**Filing Date** 2020-11-04

## APPLICANT AND AGENT DETAILS

### Applicant

Allogene Therapeutics, Inc.  
210 E. Grand Avenue  
South San Francisco, CA 94080  
UNITED STATES OF AMERICA

### Agent

CLARK WILSON LLP  
900 - 885 WEST GEORGIA STREET,  
VANCOUVER, BRITISH COLUMBIA, V6C3H1

## TRADEMARK DETAILS

# ITCAR

### Trademark Type

Standard Characters

### Goods

#### Class 05

Pharmaceutical preparations, namely, preparations for use in the treatment of cancer and tumors; pharmaceutical and biological preparations for immunotherapy, including T Cell therapy

### Claims

Priority Filing Date: May 08, 2020, Country or Office: UNITED STATES OF AMERICA, Application No: 88906321 in association with the same kind of goods

**Application Number** 2,061,979  
**International Registration Number** 1559394  
**Language of Application** English

**Filing Date** 2020-08-12

## APPLICANT AND AGENT DETAILS

### Applicant

FPT Industrial S.p.A.  
Via Puglia, 15  
I-10156 Torino  
ITALY

### Agent

AVENTUM IP LAW LLP  
Suite 104, Tower A, 555 Legget Drive, Ottawa,  
ONTARIO, K2K2X3

## TRADEMARK DETAILS

### Trademark Type

Design

### Visual Representation



### Trademark Description

The trademark consists of two curved lines reproducing the stylized image of a road, on the right of which the letters "FPT" and the wording "POWERTRAIN TECHNOLOGIES" appear.

### Goods

#### Class 01

(1) Vehicle engine coolants; anti-freeze; anti-freeze for vehicle cooling systems; anti-boil preparations for engine coolants; coolants for vehicle engines; anti-freeze for vehicle radiators; chemical additives for engine oils; chemical additives for diesel fuels; chemical additives for internal combustion engine fuels; chemical additives for use with internal combustion engine fuels; chemical additives for transmission fluids; chemical additives for fuel treatment; chemical additives for engine cooling systems; catalysts for use in the manufacture of industrial chemicals; chemical additives for fuel; chemical additives for motor fuel; chemical additives for motor fuels; chemical additives to motor fuel; chemical additives for cleaning and removing abrasive materials from engines and transmission fluids; chemical additives for fuel treatment; chemical preparations for decarbonising engines; radiator flushing chemicals; oil-purifying chemicals; gas purifying preparations.

**Class 04**

(2) All purpose industrial greases; all purpose industrial oils; motor oils; engine oils; gear oils; all purpose lubricants; lubricating oils for industrial purposes; lubricating oil for motor vehicle engines; automotive engine oils; all purpose industrial oils and greases; industrial lubricating oils; industrial lubricants; industrial wax; lubricants for industrial purposes; wax for industrial purposes; all purpose lubricating oils and greases.

**Claims**

Priority Filing Date: July 15, 2020, Country or Office: ITALY, Application No: 302020000058312 in association with the same kind of goods

**Application Number** 2,062,059  
**International Registration Number** 1559348  
**Language of Application** English

**Filing Date** 2020-09-18

## APPLICANT AND AGENT DETAILS

### Applicant

PROSOMNUS SLEEP TECHNOLOGIES INC.  
5860 West Las Positas Blvd., Suite 25  
Pleasanton CA 94588  
UNITED STATES OF AMERICA

### Agent

ERIN MCEWEN  
NELLIGAN O'BRIEN PAYNE LLP , 50  
O'Connor Street, Suite 300, Ottawa,  
ONTARIO, K1P6L2

## TRADEMARK DETAILS

# PROSOMNUS

### Trademark Type

Standard Characters

### Goods

#### Class 10

medical devices for treating sleep disorders, namely Obstructive Sleep Apnea (OSA) and snoring

**Application Number** 2,063,075  
**Language of Application** English

**Filing Date** 2020-11-10

## APPLICANT DETAILS

**Applicant**  
VIM HEALTH AND TECHNOLOGIES  
170-422 Richards St  
Vancouver  
BRITISH COLUMBIA  
V6B2Z4

## TRADEMARK DETAILS

# MONSLIM

**Trademark Type**  
Standard Characters

### Goods

#### Class 03

(1) body and beauty care cosmetics; cosmetic creams, milks, lotions, gels and powders for the face, hands and body; facial masks

#### Class 05

(2) dietary supplements for general health and well-being; dietary supplements for promoting weight loss; nutritional supplements for general health and well-being

**Application Number** 2,063,301  
**International Registration Number** 1560164  
**Language of Application** French

**Filing Date** 2020-06-04

## APPLICANT AND AGENT DETAILS

### Applicant

ESA Fabrication, LLC  
1037 E Tonto St  
Phoenix AZ 85034  
UNITED STATES OF AMERICA

### Agent

MILTONS IP/P.I.  
#200-15 Fitzgerald Road, Ottawa, ONTARIO,  
K2H9G1

## TRADEMARK DETAILS

### Trademark Type

Design

### Visual Representation



### Trademark Description

The mark consists of a stylized bullhead design.

### Goods

#### Class 09

Machines de dévidage et d'enroulement pour le transport, le stockage et le dévidage de câbles et de fils.

### Claims

Priority Filing Date: December 10, 2019, Country or Office: UNITED STATES OF AMERICA, Application No: 88721938 in association with the same kind of goods

**Application Number** 2,063,460  
**International Registration Number** 1560035  
**Language of Application** English

**Filing Date** 2020-09-25

## APPLICANT AND AGENT DETAILS

### Applicant

Gino Sorbillo Pizza Consulting srl  
Via G. Ruoppolo 105  
I-80128 Napoli  
ITALY

### Agent

BERESKIN & PARR LLP/S.E.N.C.R.L., S.R.L.  
SCOTIA PLAZA, 40 KING STREET WEST,  
40th FLOOR, TORONTO, ONTARIO, M5H3Y2

## TRADEMARK DETAILS

# ZIA ESTERINA SORBILLO

### Trademark Type

Standard Characters

### Foreign Character Translation

The translation provided by the applicant of the foreign word(s) ZIA ESTERINA SORBILLO is AUNT ESTERINA SORBILLO.

### Services

#### Class 43

Pizza parlours; delicatessens [restaurants]; bistro services; catering for the provision of food and beverages; restaurants; wine bar services; pubs; bar services; café services; hotel restaurant services; snackbars; mobile restaurant services; take-out restaurant services.

**Application Number** 2,064,487  
**Language of Application** English

**Filing Date** 2020-11-17

## APPLICANT DETAILS

### Applicant

Brad Stewart  
62 Ch De La Belle Terre  
J9B 1S5  
Chelsea  
QUEBEC  
J9B1S5

## TRADEMARK DETAILS

# CANADA IS FOOD

### Trademark Type

Standard Characters

### Goods

#### Class 09

(1) audio books; books recorded on disc; books recorded on tape; digital books downloadable from the Internet; downloadable applications for handheld computers to download music, movie and television graphics; downloadable applications for handheld computers to enable the streaming of movies and television shows; downloadable applications for handheld computers to read periodicals; downloadable applications for mobile phones to enable the streaming of movies and television shows; downloadable applications for mobile phones to download music, movie and television graphics; downloadable applications for tablet computers to download music, movie and television graphics; downloadable applications for tablet computers to enable the streaming of movies and television shows; downloadable applications for tablet computers to enable the streaming of movies and television shows;; downloadable digital audio recordings of television shows and movies; downloadable digital video recordings of television shows and movies; downloadable electronic books; DVDs containing movie recordings; DVDs containing recordings of television shows and movies; electronic books; motion pictures

#### Class 16

(2) books; cook books; cookery books; educational books; fiction books; manuscript books; picture books; reference books

### Services

#### Class 35

(1) advertising services for promoting a series of films for others; compilation, production and dissemination of advertising matter for others; distribution of products for others for advertising purposes; producing promotional videotapes, video discs, and audio visual recordings for others; production of advertising films for others; production of advertising materials for others; production of infomercials; production of television commercials

#### Class 38



(2) broadcasting of film and television features via the Internet; broadcasting of films and television programmes via a video-on-demand service; broadcasting of motion picture films via the Internet; providing streaming audio and video such as music, movies, television shows, music videos, news and sports webcasts via a website; streaming of audio and video via the Internet featuring music, movies, news, and sports; streaming of television shows and movies via the Internet; video streaming in the field of independent films; video streaming of independent films and movies via the Internet; video streaming services via the Internet featuring independent films and movies

#### **Class 41**

(3) book publishing; development of radio and television news programs; electronic desktop publishing; entertainment in the form of theatre productions; entertainment in the nature of theater productions; entertainment services in the nature of non-downloadable television shows and movies transmitted via the internet; film and video production; film production; magazine publishing; on-line electronic publishing of books and periodicals; on-line publication of electronic books and journals; online publication of electronic books and magazines; online publication of electronic books and periodicals; production of films; production of motion picture films; production of musical videos; production of radio and television programmes; production of radio and television programs; production of radio programs; production of television and radio programmes; production of television programs; providing films, not downloadable, via video-on-demand services; providing information in the field of television shows and movies via a website; publication of audio books; publication of books; publication of books and magazines; publication of books, magazines and newspapers on the Internet; publication of books, magazines, almanacs and journals; publication of electronic books and journals on-line; publication of electronic books and magazines on-line; publication of electronic books and magazines online; publication of electronic books and periodicals online; publishing and issuing scientific papers in relation to medical technology; publishing of audio books; publishing of books; publishing of books and magazines; publishing of books and reviews; publishing of catalogues; publishing of consumer magazines; publishing of electronic magazines; publishing of electronic publications; publishing of magazines in electronic form; publishing of text books; publishing of web magazines; theatre productions; video film production; video production

#### **Class 45**

(4) film, television and video licensing; issue of licensing rights relating to films; issue of licensing rights relating to television productions; issue of licensing rights relating to video productions; licensing of books; licensing of rights relating to films; licensing of rights relating to television productions; licensing of rights relating to video productions; licensing of rights to films, television and video productions

**Application Number** 2,064,939  
**International Registration Number** 1561267  
**Language of Application** English

**Filing Date** 2020-09-15

## APPLICANT DETAILS

### Applicant

Fashion Power B.V.  
Hofdreef 28C  
NL-4881 DR Zundert  
NETHERLANDS

## TRADEMARK DETAILS

### Trademark Type

Design

### Visual Representation





**Goods**

**Class 25**

sports clothing; casual and athletic clothing; outdoor winter clothing, athletic footwear; casual footwear; outdoor winter footwear; exercise footwear; hats and caps.

**Application Number** 2,064,942  
**International Registration Number** 1561042  
**Language of Application** English

**Filing Date** 2020-09-15

## APPLICANT AND AGENT DETAILS

### Applicant

Emrata Holdings, LLC  
16030 Ventura Blvd., Suite 240  
Encino CA 91436  
UNITED STATES OF AMERICA

### Agent

BERESKIN & PARR LLP/S.E.N.C.R.L., S.R.L.  
SCOTIA PLAZA, 40 KING STREET WEST,  
40th FLOOR, TORONTO, ONTARIO, M5H3Y2

## TRADEMARK DETAILS

### Trademark Type

Design

### Visual Representation

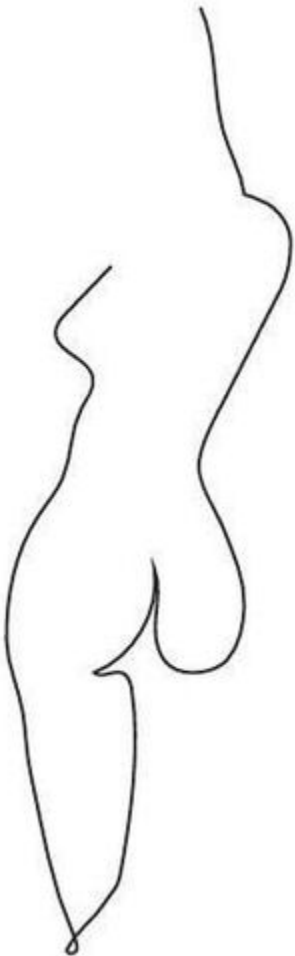

### Trademark Description

The mark consists of human figure line drawing.

### Goods

**Class 14**

(1) Jewelry; watches; key rings; clocks.

**Class 25**

(2) Clothing, namely, shirts, sweaters, skirts, pants, shorts, leggings, dresses, bodysuits, rompers, sleepwear, beach coverups, robes, hoodies, jackets, coats, belts, scarves, lingerie, under garments; headwear, namely hats, caps, head scarves, headbands; footwear, namely, socks, shoes, boots, sandals, slippers; swimwear.

**Services****Class 35**

Retail store services featuring swimwear, clothing and accessories, namely jewelry, watches, key rings, clocks, hats, caps, head scarves, headbands, socks, shoes, boots, sandals, slippers; on-line retail store services featuring swimwear, clothing and accessories, namely jewelry, watches, key rings, clocks, hats, caps, head scarves, headbands, socks, shoes, boots, sandals, slippers.

**Claims**

Priority Filing Date: March 17, 2020, Country or Office: UNITED STATES OF AMERICA,  
Application No: 88838012 in association with the same kind of goods and in association with the same kind of services

**Application Number** 2,065,337  
**Language of Application** English

**Filing Date** 2020-11-19

## APPLICANT AND AGENT DETAILS

### Applicant

Ridestore Holding AB  
c/o Ridestore AB  
Box 4021  
461 04 Trollhättan,  
SWEDEN

### Agent

BERESKIN & PARR LLP/S.E.N.C.R.L., S.R.L.  
SCOTIA PLAZA, 40 KING STREET WEST,  
40th FLOOR, TORONTO, ONTARIO, M5H3Y2

## TRADEMARK DETAILS

# DOPE

### Trademark Type

Standard Characters

### Goods

#### Class 09

(1) Helmets for use in sports; ski helmets; snowboard helmets; snow scooter helmets; helmets for bicycles; sport bags adapted [shaped] to contain protective helmets; visors for helmets; face shields for athletic use; snow goggles; snowboard goggles; scooter goggles; goggles for sports; gloves for protection against accidents; sunglasses; covers for sunglasses; ear phones; downloadable social networking software; computer software to enable teleconferencing services; computer software to enable videoconferencing services; downloadable instant messaging software for electronically exchanging text messages, photographs, graphics, music, audio books, podcasts, and voice messages; computer chatbot software for simulating conversations; computer software platforms for social networking; downloadable software and downloadable mobile applications for internet forums, message boards, chat rooms, social networks and online messaging; downloadable interactive computer software enabling exchange of information related to skiing, snowboarding, winter sports and travel; downloadable computer software that provides ski, snowboard, winter sports and travel information; downloadable newsletters, videocasts and podcasts; downloadable electronic publications in the nature of magazines; downloadable electronic publications in the nature of catalogues; downloadable publications in the nature of information pamphlets; downloadable digital content being videos.

#### Class 18

(2) Backpacks; knapsacks; all-purpose sport bags; beach bags; carry-on bags; duffle bags; gym bags; handbags; hiking bags; leather bags; shoe bags; luggage; wheeled bags; sports packs; kit bags; rucksacks; toiletry bags; pocket wallets; key cases; umbrellas.

#### Class 25

(3) Shirts; t-shirts; polo shirts; sweaters; sweatshirts; jumpers; turtlenecks; vests; coats; jeans; skirts and dresses; tights; fleece tops; yoga pants; hoodies; knit jackets; knit shirts; knit tops; knitted gloves; knitted shirts; knitted sweaters; knitted underwear; mittens; waterproof jackets and pants; gym wear; scarves; shawls; waistbands; suspenders; outdoor winter clothing; sportswear; clothing for skiing; clothing for snowboarding; athletic tops; undershirts; sports jerseys; pants;

jackets [clothing]; outerwear jackets; overtrousers; overshirts; overcoats; shorts; swim shorts; swim wear; long johns; sweat-absorbent underwear; underwear; socks; stockings; stockings for skiing; sports footwear; outdoor winter footwear; ski boots; snowboard boots; slippers; sandals; shoes; snowboard shoes; scooter shoes; hats; knit hats; headscarves; toques; visors being headwear; caps being headwear; caps with visors; ski hats; snowboard hats; headbands [clothing]; neckerchiefs; neck tube scarves; balaclavas; ski balaclavas; gloves; ski gloves; fingerless gloves; garters; belts [clothing].

### **Class 28**

(4) Snow skis; cross-country skis; bindings for skis; edges for skis; ski brakes; ski poles; covers for ski bindings; snowboards; bindings for snowboards; deck grips for snowboards; traction pads for snowboards; bags adapted for use with sporting equipment; bags adapted for snowboards; ski bags; ski sticks; snowboards; skateboards; knee guards for sports use; elbow guards for sports use; protective padding for skiing and snowboarding.

### **Services**

#### **Class 35**

Retail store services and online retail services in the field of clothing, footwear, headgear, clothing for skiing, clothing for snowboarding, neck tube scarves, ski balaclavas, gloves, ski gloves, helmets for use in sports, ski helmets, snowboard helmets, snow goggles, snowboard goggles, scooter goggles, goggles for sports, gloves for protection against accidents, sunglasses, ear phones, bags, sports packs, kit bags, rucksacks, toiletry bags, pocket wallets, key cases, umbrellas, sporting articles, sporting equipment, protective padding for skiing and snowboarding and cases adapted for sporting articles; advertising services provided via the internet, namely, promoting the goods of others by providing information regarding discounts and special offers for the goods of others; advertising the goods and services of on-line vendors via a searchable on-line guide; advertising the goods and services of others via electronic media and specifically the internet; advertising, promotion and marketing services in the nature of e-mail blast campaigns for others.

**Application Number** 2,065,342  
**Language of Application** English

**Filing Date** 2020-11-19

## APPLICANT AND AGENT DETAILS

### Applicant

Ridestore Holding AB  
c/o Ridestore AB  
Box 4021  
461 04 Trollhättan,  
SWEDEN

### Agent

BERESKIN & PARR LLP/S.E.N.C.R.L., S.R.L.  
SCOTIA PLAZA, 40 KING STREET WEST,  
40th FLOOR, TORONTO, ONTARIO, M5H3Y2

## TRADEMARK DETAILS

# DOPE SNOW

### Trademark Type

Standard Characters

### Goods

#### Class 09

(1) Helmets for use in sports; ski helmets; snowboard helmets; snow scooter helmets; helmets for bicycles; sport bags adapted [shaped] to contain protective helmets; visors for helmets; face shields for athletic use; snow goggles; snowboard goggles; scooter goggles; goggles for sports; gloves for protection against accidents; sunglasses; covers for sunglasses; ear phones; downloadable social networking software; computer software to enable teleconferencing services; computer software to enable videoconferencing services; downloadable instant messaging software for electronically exchanging text messages, photographs, graphics, music, audio books, podcasts, and voice messages; computer chatbot software for simulating conversations; computer software platforms for social networking; downloadable software and downloadable mobile applications for internet forums, message boards, chat rooms, social networks and online messaging; downloadable interactive computer software enabling exchange of information related to skiing, snowboarding, winter sports and travel; downloadable computer software that provides ski, snowboard, winter sports and travel information; downloadable newsletters, videocasts and podcasts; downloadable electronic publications in the nature of magazines; downloadable electronic publications in the nature of catalogues; downloadable publications in the nature of information pamphlets; downloadable digital content being videos.

#### Class 18

(2) Backpacks; knapsacks; all-purpose sport bags; beach bags; carry-on bags; duffle bags; gym bags; handbags; hiking bags; leather bags; shoe bags; luggage; wheeled bags; sports packs; kit bags; rucksacks; toiletry bags; pocket wallets; key cases; umbrellas.

#### Class 25

(3) Shirts; t-shirts; polo shirts; sweaters; sweatshirts; jumpers; turtlenecks; vests; coats; jeans; skirts and dresses; tights; fleece tops; yoga pants; hoodies; knit jackets; knit shirts; knit tops; knitted gloves; knitted shirts; knitted sweaters; knitted underwear; mittens; waterproof jackets and pants; gym wear; scarves; shawls; waistbands; suspenders; outdoor winter clothing; sportswear; clothing for skiing; clothing for snowboarding; athletic tops; undershirts; sports jerseys; pants;



jackets [clothing]; outerwear jackets; overtrousers; overshirts; overcoats; shorts; swim shorts; swim wear; long johns; sweat-absorbent underwear; underwear; socks; stockings; stockings for skiing; sports footwear; outdoor winter footwear; ski boots; snowboard boots; slippers; sandals; shoes; snowboard shoes; scooter shoes; hats; knit hats; headscarves; toques; visors being headwear; caps being headwear; caps with visors; ski hats; snowboard hats; headbands [clothing]; neckerchiefs; neck tube scarves; balaclavas; ski balaclavas; gloves; ski gloves; fingerless gloves; garters; belts [clothing].

### **Class 28**

(4) Snow skis; cross-country skis; bindings for skis; edges for skis; ski brakes; ski poles; covers for ski bindings; snowboards; bindings for snowboards; deck grips for snowboards; traction pads for snowboards; bags adapted for use with sporting equipment; bags adapted for snowboards; ski bags; ski sticks; snowboards; skateboards; knee guards for sports use; elbow guards for sports use; protective padding for skiing and snowboarding.

### **Services**

#### **Class 35**

Retail store services and online retail services in the field of clothing, footwear, headgear, clothing for skiing, clothing for snowboarding, neck tube scarves, ski balaclavas, gloves, ski gloves, helmets for use in sports, ski helmets, snowboard helmets, snow goggles, snowboard goggles, scooter goggles, goggles for sports, gloves for protection against accidents, sunglasses, ear phones, bags, sports packs, kit bags, rucksacks, toiletry bags, pocket wallets, key cases, umbrellas, sporting articles, sporting equipment, protective padding for skiing and snowboarding and cases adapted for sporting articles; advertising services provided via the internet, namely, promoting the goods of others by providing information regarding discounts and special offers for the goods of others; advertising the goods and services of on-line vendors via a searchable on-line guide; advertising the goods and services of others via electronic media and specifically the internet; advertising, promotion and marketing services in the nature of e-mail blast campaigns for others.

**Application Number** 2,065,346  
**Language of Application** English

**Filing Date** 2020-11-19

## APPLICANT AND AGENT DETAILS

### Applicant

Ridestore Holding AB  
c/o Ridestore AB  
Box 4021  
461 04 Trollhättan,  
SWEDEN

### Agent

BERESKIN & PARR LLP/S.E.N.C.R.L., S.R.L.  
SCOTIA PLAZA, 40 KING STREET WEST,  
40th FLOOR, TORONTO, ONTARIO, M5H3Y2

## TRADEMARK DETAILS

### Trademark Type

Design

### Visual Representation

The image shows the word "dope" in a very bold, lowercase, sans-serif typeface. The letters are thick and black, with large white circular cutouts in the 'o's and 'p'. The 'd' has a thick vertical stem. The 'e' is also thick and has a white cutout. The overall style is modern and graphic.

### Goods

#### Class 09

(1) Helmets for use in sports; ski helmets; snowboard helmets; snow scooter helmets; helmets for bicycles; sport bags adapted [shaped] to contain protective helmets; visors for helmets; face shields for athletic use; snow goggles; snowboard goggles; scooter goggles; goggles for sports; gloves for protection against accidents; sunglasses; covers for sunglasses; ear phones.

#### Class 18

(2) Backpacks; knapsacks; all-purpose sport bags; beach bags; carry-on bags; duffle bags; gym bags; handbags; hiking bags; leather bags; shoe bags; luggage; wheeled bags; sports packs; kit bags; rucksacks; toiletry bags; pocket wallets; key cases; umbrellas.

#### Class 25

(3) Shirts; t-shirts; polo shirts; sweaters; sweatshirts; jumpers; turtlenecks; vests; coats; jeans; skirts and dresses; tights; fleece tops; yoga pants; hoodies; knit jackets; knit shirts; knit tops; knitted gloves; knitted shirts; knitted sweaters; knitted underwear; mittens; waterproof jackets and

pants; gym wear; scarves; shawls; waistbands; suspenders; outdoor winter clothing; sportswear; clothing for skiing; clothing for snowboarding; athletic tops; undershirts; sports jerseys; pants; jackets [clothing]; outerwear jackets; overtrousers; overshirts; overcoats; shorts; swim shorts; swim wear; long johns; sweat-absorbent underwear; underwear; socks; stockings; stockings for skiing; sports footwear; outdoor winter footwear; ski boots; snowboard boots; slippers; sandals; shoes; snowboard shoes; scooter shoes; hats; knit hats; headscarves; toques; visors being headwear; caps being headwear; caps with visors; ski hats; snowboard hats; headbands [clothing]; neckerchiefs; neck tube scarves; balaclavas; ski balaclavas; gloves; ski gloves; fingerless gloves; garters; belts [clothing].

**Class 28**

(4) Snow skis; cross-country skis; bindings for skis; edges for skis; ski brakes; ski poles; covers for ski bindings; snowboards; bindings for snowboards; deck grips for snowboards; traction pads for snowboards; bags adapted for use with sporting equipment; bags adapted for snowboards; ski bags; ski sticks; snowboards; skateboards; knee guards for sports use; elbow guards for sports use; protective padding for skiing and snowboarding.

**Services****Class 35**

Retail store services and online retail services in the field of clothing, footwear, headgear, clothing for skiing, clothing for snowboarding, neck tube scarves, ski balaclavas, gloves, ski gloves, helmets for use in sports, ski helmets, snowboard helmets, snow goggles, snowboard goggles, scooter goggles, goggles for sports, gloves for protection against accidents, sunglasses, ear phones, bags, sports packs, kit bags, rucksacks, toiletry bags, pocket wallets, key cases, umbrellas, sporting articles, sporting equipment, protective padding for skiing and snowboarding and cases adapted for sporting articles; advertising services provided via the internet, namely, promoting the goods of others by providing information regarding discounts and special offers for the goods of others; advertising the goods and services of on-line vendors via a searchable on-line guide; advertising the goods and services of others via electronic media and specifically the internet; advertising, promotion and marketing services in the nature of e-mail blast campaigns for others.

Application Number 2,065,973  
Language of Application English

Filing Date 2020-11-24

## APPLICANT DETAILS

### Applicant

Shobha Bhattarai  
213 West 45th Avenue  
Vancouver  
BRITISH COLUMBIA  
V5Y2W3

## TRADEMARK DETAILS

### Trademark Type

Design

### Visual Representation



The image shows a handwritten trademark design. The word "Kumma" is written in a red, cursive script. The word "Bea" is written in a black, cursive script below "Kumma". A red line starts from the bottom of the "K" in "Kumma" and extends to the left, then curves back to the right, ending under the "B" in "Bea".

Colour Claim

Colour is claimed as a feature of the trademark. Kumari in Red Colour and Beauty in Black Colour

**Goods****Class 03**

(1) anti-aging creams for cosmetic use; artificial nail adhesives; artificial nails; baby lotion; baby shampoo; bath and shower foam; bath and shower gels; bath bombs; bath crystals; bath soap; beauty masks; blush; blushers; body deodorants; body glitter; body mist; body moisturizers; body wash; cheek blush; cheek colours; cleansing milk for cosmetic purposes; cosmetic concealers; cosmetic face powders; cosmetic facial lotions; cosmetic facial masks; cosmetic facial moisturizers; cosmetic facial packs; cosmetic facial toners; eye creams for cosmetic purposes; eye liner; eye make-up; eye make-up removers; eye pencils; eye shadow; glitter for cosmetic purposes; lip balm; lip cream; lip glosses; lip liners; lipstick cases; lipsticks; liquid eyeliners; liquid foundation; make-up primer; makeup remover; mascara; nail polish; nail polish base coat; nail polish pens; nail polish removers; nail topcoats; shampoo bars; skin bronzer; skin bronzing creams; skin care cosmetics; sun block lotions; sun block lotions for cosmetic purposes; under-eye enhancers

**Class 04**

(2) perfumed candles

**Application Number** 2,066,008  
**Language of Application** English

**Filing Date** 2020-11-24

## APPLICANT AND AGENT DETAILS

### Applicant

Grupo Bimbo S.A.B. de C.V.  
Prolongación Paseo de la Reforma No. 1000  
Col. Peña Blanca Santa Fe, C.P. 01210  
Distrito Federal,  
MEXICO

### Agent

SMART & BIGGAR LP  
1100-150 York street, TORONTO, ONTARIO,  
M5H3S5

## TRADEMARK DETAILS

### Trademark Type

Design

### Visual Representation



### Colour Claim

Colour is claimed as a feature of the trademark. The background of the design and the bag is medium purple and dark purple with a light grey shadow along the right side and the bottom of the bag. The banner design at the top left is yellow. The phrase NEW LOOK SAME INTENSITY is purple. The word TAKIS is yellow with a purple border. The stylized dot above the letter I is yellow with a purple swirl and orange flames emanating therefrom. The banner design featured below the word TAKIS is yellow with a dark purple shadow and features the word FUEGO in purple. The small dots on the banner design are orange. The lime is green and the rolled corn snacks are red. The flames featured behind the lime and rolled corn snacks are yellow and orange. The chili pepper inside the flame is red with a green stem. The chili pieces around the flame are red and the seeds therein are yellow. The small dots on the lime and the chili pepper are black. The

thermometer design element at the bottom left is yellow with a red border. The flame, the vertical line and the dots inside the design element are red. The phrase EXTREME is yellow. The phrase CONT. NET. 60g is white.

**Foreign Character Translation**

The translation provided by the applicant of the Spanish word "FUEGO" means "fire" in English.

**Goods****Class 30**

Corn tortilla chips; corn-based snack foods

**Application Number** 2,066,497  
**Language of Application** English

**Filing Date** 2020-11-27

## **APPLICANT AND AGENT DETAILS**

### **Applicant**

Liu Xueyong  
17B, Building 6C Yongjing Wan, Shekou  
Nanshan  
District Shenzhen 518067  
CHINA

### **Agent**

MILTONS IP/P.I.  
#200-15 Fitzgerald Road, Ottawa, ONTARIO,  
K2H9G1

## **TRADEMARK DETAILS**

### **Trademark Type**

Design

### **Visual Representation**

**unokt**



**Goods****Class 15**

Pianos; Harmonicas; stands for musical instruments; Stringed musical instruments; Flutes; Guitars; Electronic musical instruments; musical instrument drums; musical instrument handbells; Music synthesizers; Robotic drums; electronic musical keyboards; string instruments; percussion instruments; steel drums being musical instruments; brass instruments; Marimbas; Wind instruments; Keyboard instruments; Musical boxes.

**Application Number** 2,066,731  
**International Registration Number** 1562389  
**Language of Application** English

**Filing Date** 2020-06-09

**APPLICANT DETAILS**

**Applicant**  
Bayerische MotorenWerke Aktiengesellschaft  
Petuelring 130  
80809 München  
GERMANY

**TRADEMARK DETAILS**

**Trademark Type**  
Design

**Visual Representation**

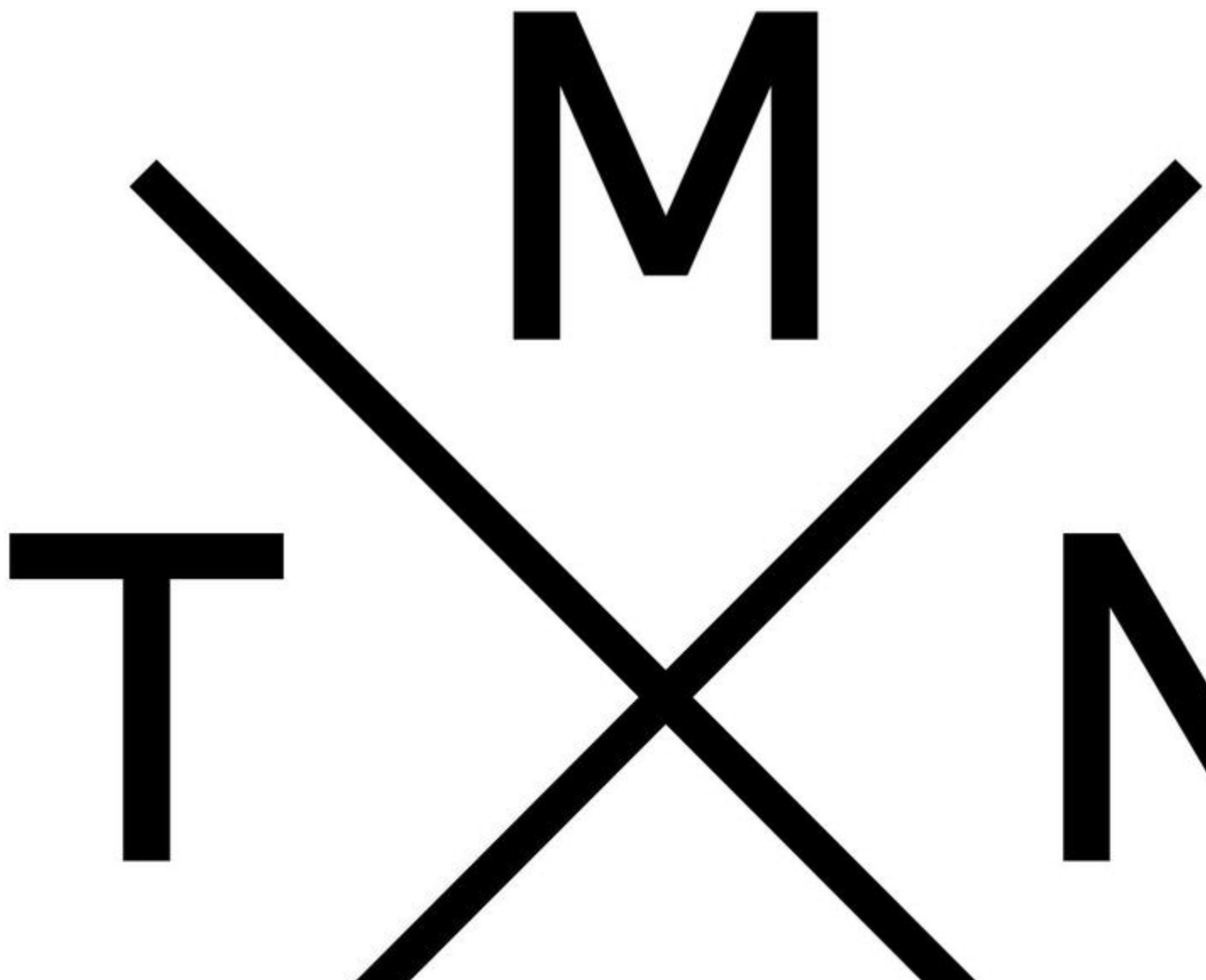

**Goods****Class 16**

(1) Paper and cardboard; Bags and articles of paper, cardboard or plastics, for packaging, wrapping and storage; Stationery, namely, paper stationery sets, pencils, writing stationery, stationery agendas, organizers for stationery use, staplers; office requisites, except furniture, namely rubber bands; adhesives for stationery or household purposes; money holders; printed matter, namely, books, reports, magazines, and brochures in the the field of automobiles and automobile clubs and automobile enthusiasts events

**Class 18**

(2) Umbrellas and parasols; walking sticks; luggage, all-purpose carrying bags, leather bags, purses; satchels and luggage; saddlery, whips and apparel for animals; parts, fittings and accessories for all the aforesaid goods

**Class 21**

(3) Statues, figurines, signs and works of art of porcelain, earthenware and glass; unworked and semi-worked glass, not specified for use; brushes, except paintbrushes and brooms as well as other cleaning utensils, namely household scrubbing brushes; tableware, cookware and food and beverage containers for household use; cosmetic and toilet utensils; Articles for animals, namely aquariums and vivariums, devices for pest and vermin control, bird baths, cages, feeding and drinking articles, fish bowls, grooming articles, nesting articles, swing tags, waste disposal articles; household articles for clothing and footwear, namely boot jacks and shoehorns, button hooks, clothes racks, stretchers for clothing, trouser presses electric and non-electric shoe polishers, shoe trees (stretchers) and shapers; cooking utensils; earthenware plates; mugs; napkin holders and rings; bottle openers; corkscrews; coasters; powder compacts; perfume sprayers; portable coolers and vacuum bottles, all for food and/or beverages; kitchen scrubbing brushes; plates; cooking pot sets; kitchen containers; glasses; drinking vessels; barware

**Class 25**

(4) Hats and caps; clothing, namely, casual and athletic clothing, business clothing, sports clothing, clothing for children, belts, scarves

**Claims**

Priority Filing Date: March 27, 2020, Country or Office: GERMANY, Application No: 30 2020 104 104 in association with the same kind of goods

**Application Number** 2,067,098  
**International Registration Number** 1562265  
**Language of Application** English

**Filing Date** 2020-10-21

## APPLICANT AND AGENT DETAILS

### Applicant

ZORG INDUSTRIES PTY LTD  
Unit 2, 2-6 Chaplin Drive  
LANE COVE NSW 2066  
AUSTRALIA

### Agent

CASSAN MACLEAN IP AGENCY INC.  
190 O'CONNOR STREET, SUITE 710,  
OTTAWA, ONTARIO, K2P2R3

## TRADEMARK DETAILS

### Trademark Type

Design

### Visual Representation



### Goods

#### Class 09

Electronic devices and systems utilizing radar, sonar, ultrasonic, photographic, infrared and visual assistance technology for collision avoidance, collision warning, proximity detection and distance control, namely, proximity sensors, electronic distance sensors, electronic acceleration sensors, electronic velocity sensors, and collision warning sensors; electronic devices and systems utilizing radar, sonar, ultrasonic, photographic, infrared and visual assistance technology for collision avoidance, collision warning, proximity detection, distance control, namely, proximity sensors, electronic distance sensors, electronic acceleration sensors, electronic velocity sensors, and collision warning sensors, for use with land vehicles, motor vehicles, aircraft and watercraft.

### Claims

Priority Filing Date: August 07, 2020, Country or Office: AUSTRALIA, Application No: 2110167 in association with the same kind of goods

**Application Number** 2,067,562  
**Language of Application** English

**Filing Date** 2020-12-02

## APPLICANT AND AGENT DETAILS

### Applicant

Huadong Ruan  
No.780, Ruanjiabu Village, Ruanshi Town  
Zhuji City, Zhejiang Province,  
CHINA

### Agent

NEOMARK LTD.  
7450 rue Saint-Hubert, Montréal, QUEBEC,  
H2R2N3

## TRADEMARK DETAILS

### Trademark Type

Design

### Visual Representation



**KXLife**

### Goods

#### Class 20

bamboo curtains; bedroom furniture; blinds of reed, rattan or bamboo (sudare); chair pads; curtain hooks; curtain rails; curtain rings; curtain rods; curtain rollers; curtain tie-backs; cushions; decorative bead curtains; indoor window blinds; indoor window shades of paper; indoor window shades of textile; shower curtain hooks; vertical blinds; window blinds; window shades

**Application Number** 2,067,842  
**International Registration Number** 1563180  
**Language of Application** English

**Filing Date** 2020-08-18

## APPLICANT AND AGENT DETAILS

### Applicant

Enviro Specialty Chemicals, Inc.  
160 Quarry Park Blvd  
Suite 300  
Calgary T2C 3G3  
CANADA

### Agent

GOWLING WLG (CANADA) LLP  
SUITE 2600, 160 ELGIN STREET, OTTAWA,  
ONTARIO, K1P1C3

## TRADEMARK DETAILS

# ZETRISIL

### Trademark Type

Standard Characters

### Goods

#### Class 05

All purpose disinfectants; antibacterial skin sanitizer preparations; antibacterial spray; antifungal preparations; antimicrobial coatings to treat the growth of mold, mildew, bacteria and fungus on various surfaces, namely, antimicrobial preparations for inhibiting microbiological growth; antivirals; biocides, germicides, bactericides, virucides, fungicides, insecticides, pesticides and herbicides; mold inhibiting chemicals for treating mold growth in and around buildings, namely, antimicrobial preparations for inhibiting microbiological growth; spray sanitizer, namely, all-purpose sanitizers and insect repellent for personal use.

**Application Number** 2,067,872  
**International Registration Number** 1563042  
**Language of Application** English

**Filing Date** 2020-09-07

## APPLICANT AND AGENT DETAILS

### Applicant

KITAZAWA Kazutoshi  
2-7, Sakaedori 19-chome,  
Shiroishi-ku, Sapporo-shi  
Hokkaido 003-0021  
JAPAN

### Agent

RICHARD UDITSKY  
(ROBINSON SHEPPARD SHAPIRO S.E.N.C.  
R.L./L.L.P.), 800 Place Victoria , Suite 4600 ,  
Montreal, QUEBEC, H4Z1H6

## TRADEMARK DETAILS

### Trademark Type

Design

### Visual Representation

**F U M A N**

### Goods

#### Class 28

Sports equipment for walking motion, namely, lattice-shaped nets and ladders for use in connection with walking exercises; nets for sports; exercise platforms; stair-climbing machines for exercise.

### Services

#### Class 41

Gymnastic instruction; conducting fitness classes; online library services; providing gymnastic facilities.

### Claims

Priority Filing Date: May 26, 2020, Country or Office: JAPAN, Application No: 2020-064783 in association with the same kind of goods and in association with the same kind of services

**Application Number** 2,068,533  
**Language of Application** English

**Filing Date** 2020-12-04

## APPLICANT AND AGENT DETAILS

### Applicant

Sperr & Lechner SPLEK Maschinenbau GmbH  
& Co. KG  
Hertlingweg 26  
74613 Öhringen-Ohrnberg,  
GERMANY

### Agent

BORDEN LADNER GERVAIS LLP  
World Exchange Plaza, 100 Queen Street,  
Suite 1300, Ottawa, ONTARIO, K1P1J9

## TRADEMARK DETAILS

### Trademark Type

Design

### Visual Representation



### Foreign Character Translation

The translation provided by the applicant of the word(s) BIEGEMASTER is 'bending master'.

### Goods

#### Class 07

machine tools for the metalworking industry, bending machines for metalworking



**Application Number** 2,069,879  
**International Registration Number** 1564301  
**Language of Application** English

**Filing Date** 2020-10-28

## APPLICANT AND AGENT DETAILS

### Applicant

Apple Inc.  
One Apple Park Way  
Cupertino CA 95014  
UNITED STATES OF AMERICA

### Agent

BAKER & MCKENZIE LLP  
BROOKFIELD PLACE, 181 BAY STREET,  
SUITE 2100, P.O. BOX 874, TORONTO,  
ONTARIO, M5J2T3

## TRADEMARK DETAILS

# MAGSAFE CHARGER

### Trademark Type

Standard Characters

### Goods

#### Class 09

Charging mats for use with smartphones; charging apparatus for use with mobile telephones, namely, wireless chargers for mobile telephones; mobile phone chargers.

### Claims

Priority Filing Date: August 13, 2020, Country or Office: JAMAICA, Application No: 81199 in association with the same kind of goods

**Application Number** 2,069,896  
**International Registration Number** 1564470  
**Language of Application** English

**Filing Date** 2020-10-29

## APPLICANT AND AGENT DETAILS

### Applicant

UAB "Northway turto valdymas"  
S. Zukauskio g. 21-43  
Vilnius  
LITHUANIA

### Agent

BCF S.E.N.C.R.L./BCF LLP  
1100, boul. René-Lévesque Ouest, 25e Étage,  
Montréal, QUEBEC, H3B5C9

## TRADEMARK DETAILS

# BUMMELL

### Trademark Type

Standard Characters

### Goods

#### Class 05

Pharmaceutical preparations, drugs for medical purposes, biological preparations for medical purposes and chemical preparations for medical purpose namely, pharmaceutical preparations for use in oncology, cardiovascular treatment preparations, pharmaceutical preparations for the treatment of respiratory diseases, disorders and infections, anti-inflammatory medications, pharmaceutical preparations for treatment of autoimmune diseases and disorders, pharmaceutical preparations for the treatment of degenerative nerve diseases and disorders, namely, Alzheimer's disease, Parkinson's disease, Huntington's disease and multiple sclerosis; pharmaceutical preparations for the treatment of arthritis, allergy medication, pharmaceuticals for the treatment of coronavirus diseases and COVID-19; biological tissue cultures for medical purposes; albumin dietary supplements.

### Services

#### Class 42

(1) Scientific and technological services, namely, research and development in the field of biotechnology products and processes; scientific research, namely, scientific research in the field of pharmacology, pharmaceuticals, and biochemistry; scientific laboratory services, namely, medical research laboratory services; chemistry services, namely, chemistry research laboratory services; technical research, namely, technical surveying; technological consulting services for the medical industry; bacteriological research; biological research; chemical research; clinical trials; medical research.

#### Class 44

(2) Midwife services; in vitro fertilization services; chiropractic; physiotherapy; human tissue bank services; hospital services; rental of medical equipment; medical clinic services; medical analysis services for diagnostic and treatment purposes provided by medical laboratories; opticians' services; plastic surgery; services of a psychologist; convalescent home services; preparation of prescriptions by pharmacists; rehabilitation for substance abuse patients; nursing, medical; medical screening; telemedicine services.

**Claims**

Priority Filing Date: May 07, 2020, Country or Office: LITHUANIA, Application No: 2020 0744 in association with the same kind of goods and in association with the same kind of services

**Application Number** 2,069,903  
**International Registration Number** 1564000  
**Language of Application** English

**Filing Date** 2020-10-30

## APPLICANT AND AGENT DETAILS

### Applicant

Eduphoria! Incorporated  
1700 Alma Drive, Suite 410  
Plano TX 75075  
UNITED STATES OF AMERICA

### Agent

BAKER & MCKENZIE LLP  
BROOKFIELD PLACE, 181 BAY STREET,  
SUITE 2100, P.O. BOX 874, TORONTO,  
ONTARIO, M5J2T3

## TRADEMARK DETAILS

# EDUPHEST

### Trademark Type

Standard Characters

### Services

#### Class 41

Arranging and conducting educational conferences for educators in the field of school administration and management; educational services, namely, developing, arranging, and conducting educational conferences and programs for educators and school administrators in the field of education, namely, teaching methodology and pedagogy, professional learning, development and coaching, teaching techniques for learning in a virtual environment, assessment literacy, culture and diversity in the school environment, student evaluation and monitoring student progress, classroom management, course management and curriculum planning; organizing online conferences for educators and school administrators in the field of education, namely, teaching methodology and pedagogy, professional learning, development and coaching, teaching techniques for learning in a virtual environment, assessment literacy, culture and diversity in the school environment, student evaluation and monitoring student progress, classroom management, course management and curriculum planning.

### Claims

Priority Filing Date: September 30, 2020, Country or Office: UNITED STATES OF AMERICA, Application No: 90225825 in association with the same kind of services

**Application Number** 2,070,544  
**Language of Application** English

**Filing Date** 2020-12-11

## APPLICANT AND AGENT DETAILS

### Applicant

Parvasi Weekly Inc.  
219-2975 Drew Rd  
Mississauga  
ONTARIO  
L4T0A1

### Agent

TRADEMARK DEPOT  
3772 De La Goudrelle, Saint-Lazare,  
QUEBEC, J7T2N1

## TRADEMARK DETAILS

# PARVASI

### Trademark Type

Standard Characters

### Goods

#### Class 09

(1) electronic newspapers

#### Class 16

(2) directories; newspapers

### Services

#### Class 35

(1) providing an online commercial information directory on the Internet; travel management

#### Class 36

(2) charitable fundraising services; property management; real estate investment; real estate management

#### Class 37

(3) real estate development

#### Class 38

(4) radio and television broadcasting

#### Class 39

(5) arranging travel tours; travel arrangement

#### Class 41

(6) Providing on-line non-downloadable newspapers  
(7) event planning

**Application Number** 2,071,084  
**Language of Application** French

**Filing Date** 2020-12-15

## APPLICANT AND AGENT DETAILS

### Applicant

9310-2689 Québec inc.  
310 Rue Marcel-Giguère  
Blainville  
QUÉBEC  
J7B2A6

### Agent

THERRIEN COUTURE JOLI-COEUR S.E.N.C.  
R.L.  
1100, boul. René-Lévesque O., #2000,  
Montréal, QUÉBEC, H3B4N4

## TRADEMARK DETAILS

# ACADEMIE HYPERCROISSANCE

### Trademark Type

Standard Characters

### Services

#### Class 41

Training in the form of workshops, videos, podcasts, blogs, conferences and testimonials in the field of business and business management and for the launch of books on the subjects of business and business management; training for coaching and mentoring in the field entrepreneurship and business management; training in the form of workshops, videos, podcasts, blogs, conferences and testimonials aimed at having participants practice entrepreneurial concepts related to the planning and strategic direction of a business, the role of personnel and members of the management team, execution of a strategic plan and the management of cash assets (finances) of the business.

**Application Number** 2,071,085  
**Language of Application** French

**Filing Date** 2020-12-15

## APPLICANT AND AGENT DETAILS

### Applicant

9310-2689 Québec inc.  
310 Rue Marcel-Giguère  
Blainville  
QUÉBEC  
J7B2A6

### Agent

THERRIEN COUTURE JOLI-COEUR S.E.N.C.  
R.L.  
1100, boul. René-Lévesque O., #2000,  
Montréal, QUÉBEC, H3B4N4

## TRADEMARK DETAILS

# METHODE HYPERCROISSANCE

### Trademark Type

Standard Characters

### Services

#### Class 41

Training in the form of workshops, videos, podcasts, blogs, conferences and testimonials in the field of business and business management and for the launch of books on the subjects of business and business management; training for coaching and mentoring in the field entrepreneurship and business management; training in the form of workshops, videos, podcasts, blogs, conferences and testimonials aimed at having participants practice entrepreneurial concepts related to the planning and strategic direction of a business, the role of personnel and members of the management team, execution of a strategic plan and the management of cash assets (finances) of the business.

**Application Number** 2,071,484  
**International Registration Number** 1565560  
**Language of Application** English

**Filing Date** 2020-07-09

## APPLICANT DETAILS

### Applicant

Bayerische Motoren Werke Aktiengesellschaft  
Petuelring 130  
80809 München  
GERMANY

## TRADEMARK DETAILS

# Never Stop Challenging

### Trademark Type

Standard Characters

### Goods

#### Class 12

Motorcycles; parts and fittings for motorcycles.

### Services

#### Class 35

(1) Retail store and online retail store services in relation to motorcycles and parts therefore.

#### Class 41

(2) Organizing and conducting of motorcycle rally events and motorcycle racing competitions; entertainment services in the nature of motorcycle racing and motorcycle exhibitions; organizing and conducting of motorcycle driver trainings; entertainment services in the nature of motorcycle club services, namely, organizing and conducting motorcycle shows for entertainment purposes; organizing and conducting events in relation to motorcycle club services for social entertainment purposes.

### Claims

Priority Filing Date: March 03, 2020, Country or Office: GERMANY, Application No: 30 2020 102 901 in association with the same kind of goods and in association with the same kind of services



**Application Number** 2,071,789  
**International Registration Number** 1282462  
**Language of Application** English

**Filing Date** 2020-11-26

## APPLICANT AND AGENT DETAILS

### Applicant

The Foraging Fox Limited  
Huckle West,  
191 Wood Lane  
London W12 7FP  
UNITED KINGDOM

### Agent

BERESKIN & PARR LLP/S.E.N.C.R.L., S.R.L.  
SCOTIA PLAZA, 40 KING STREET WEST,  
40th FLOOR, TORONTO, ONTARIO, M5H3Y2

## TRADEMARK DETAILS

### Trademark Type

Design

### Visual Representation



### Colour Claim

Colour is claimed as a feature of the trademark. The body of the animal appears in orange, the tip of the animal tail appears in white, with orange border.

### Goods

#### Class 29

(1) Meat, fish, poultry and game; meat extracts; preserved, frozen, and dried fruits and vegetables; prepared and packaged meals consisting primarily of cooked fruits and vegetables; jellies, jams,

compotes; eggs; milk and milk products; edible oils and fats; vegetable juice concentrates for food; extracts of vegetables [juices] for cooking; jellies, jams, compotes, fruit and vegetable spreads; organic processed fruits and vegetables; canned fruits and vegetables; fruit fillings; fruit mousses; fruit preserves; fruit purees; fruit-based concentrate for cooking; fruit-based dips; fermented vegetables [kimchi]; pickled vegetables; preserved vegetables; vegetable concentrates for culinary purposes; vegetable fats for food; vegetable mousses; vegetable paste purees; vegetable soufflés; dried edible fungi; pulses, preserved; pulses, canned; dried pulses; blanched nuts; candied nuts; processed flavored nuts; nut butters; nut topping; seasoned nuts; vegetable juices for cooking; vegetable pate; fruit paste; fruit spread; fruit pulp; fruit marmalade; fruit jams; fruit juices for cooking.

### **Class 30**

(2) Coffee, tea, cocoa and artificial coffee; rice; tapioca and sago; flour; breakfast cereals; cereal bars; oat bran cereals; ready-to-eat cereals; cereal-based snack foods; bread; pastry; almond confectionery; chocolate confectionery; coconut confectionery; confectionery fruit jellies; confectionery fruit pastes; confectionery in the form of mousses; frozen confectionery; fruit confectionery; fruit-based confectionery; nut-based confectionery; raisin confectionery; sugar confectionery; edible ices; sugar, honey, treacle; yeast, baking-powder; salt; mustard; vinegar; chutney condiments; tamarind being condiment; spices; ice; ketchup; ketchup [sauce]; vegetable pulps [sauces - food]; sauces for use with pasta; sauces for barbecued meat; sauces for chicken; sauces for rice; vegetable pastes [sauces]; vegetable purees [sauces]; sauces for pasta; dressings for salads; salad sauces; fruit sauces; tomato sauce; barbecue sauce; artichoke sauce.

### **Class 32**

(3) Beers; mineral and aerated waters; non-alcoholic beer; non-alcoholic aperitifs; non-alcoholic beer flavored beverages; non-alcoholic beverages flavored with coffee; non-alcoholic beverages flavored with tea; non-alcoholic beverages flavoured with chocolate; non-alcoholic carbonated beverages; non-alcoholic cider; non-alcoholic cocktails; fruit beverages and fruit juices; syrups for making beverages; concentrates for making fruit beverages; fruit purées for making beverages; lemon juice for use in the preparation of beverages; lime juice for use in the preparation of beverages; mixes in the nature of powders used in the preparation of flavored non-alcoholic beverages; non-alcoholic fruit extracts used in the preparation of beverages; fruit drinks; fruit-based beverages; fruit juice beverages; fruit squashes; fruit flavoured beverages; fruit juice concentrates; fruit flavoured soft drinks; non-alcoholic fruit juice beverages; vegetable drinks; vegetable juice; vegetable juices [beverages].

**Application Number** 2,071,790  
**International Registration Number** 1275721  
**Language of Application** English

**Filing Date** 2020-11-26

## APPLICANT AND AGENT DETAILS

### Applicant

The Foraging Fox Limited  
Huckle West,  
191 Wood Lane  
London W12 7FP  
UNITED KINGDOM

### Agent

BERESKIN & PARR LLP/S.E.N.C.R.L., S.R.L.  
SCOTIA PLAZA, 40 KING STREET WEST,  
40th FLOOR, TORONTO, ONTARIO, M5H3Y2

## TRADEMARK DETAILS

# THE FORAGING FOX

### Trademark Type

Standard Characters

### Goods

#### Class 29

(1) Meat, fish, poultry and game; meat extracts; preserved, frozen, and dried fruits and vegetables; prepared and packaged meals consisting primarily of cooked fruits and vegetables; jellies, jams, compotes; eggs; milk and milk products; edible oils and fats; vegetable juice concentrates for food; extracts of vegetables [juices] for cooking; jellies, jams, compotes, fruit and vegetable spreads; organic processed fruits and vegetables; canned fruits and vegetables; fruit fillings; fruit mousses; fruit preserves; fruit purees; fruit-based concentrate for cooking; fruit-based dips; fermented vegetables [kimchi]; pickled vegetables; preserved vegetables; vegetable concentrates for culinary purposes; vegetable fats for food; vegetable mousses; vegetable paste purees; vegetable soufflés; dried edible fungi; pulses, preserved; pulses, canned; dried pulses; blanched nuts; candied nuts; processed flavored nuts; nut butters; nut topping; seasoned nuts; vegetable juices for cooking; vegetable pate; fruit paste; fruit spread; fruit pulp; fruit marmalade; fruit jams; fruit juices for cooking.

#### Class 30

(2) Coffee, tea, cocoa and artificial coffee; rice; tapioca and sago; flour; breakfast cereals; cereal bars; oat bran cereals; ready-to-eat cereals; cereal-based snack foods; bread; pastry; almond confectionery; chocolate confectionery; coconut confectionery; confectionery fruit jellies; confectionery fruit pastes; confectionery in the form of mousses; frozen confectionery; fruit confectionery; fruit-based confectionery; nut-based confectionery; raisin confectionery; sugar confectionery; edible ices; sugar, honey, treacle; yeast, baking-powder; salt; mustard; vinegar; chutney condiments; tamarind being condiment; spices; ice; ketchup; ketchup [sauce]; vegetable pulps [sauces - food]; sauces for use with pasta; sauces for barbecued meat; sauces for chicken; sauces for rice; vegetable pastes [sauces]; vegetable purees [sauces]; sauces for pasta; dressings for salads; salad sauces; fruit sauces; tomato sauce; barbecue sauce; artichoke sauce.

#### Class 32

(3) Beers; mineral and aerated waters; non-alcoholic beer; non-alcoholic aperitifs; non-alcoholic beer flavored beverages; non-alcoholic beverages flavored with coffee; non-alcoholic beverages flavored with tea; non-alcoholic beverages flavoured with chocolate; non-alcoholic carbonated beverages; non-alcoholic cider; non-alcoholic cocktails; fruit beverages and fruit juices; syrups for making beverages; concentrates for making fruit beverages; fruit purées for making beverages; lemon juice for use in the preparation of beverages; lime juice for use in the preparation of beverages; mixes in the nature of powders used in the preparation of flavored non-alcoholic beverages; non-alcoholic fruit extracts used in the preparation of beverages; fruit drinks; fruit-based beverages; fruit juice beverages; fruit squashes; fruit flavoured beverages; fruit juice concentrates; fruit flavoured soft drinks; non-alcoholic fruit juice beverages; vegetable drinks; vegetable juice; vegetable juices [beverages].

**Application Number** 2,073,386  
**International Registration Number** 1566343  
**Language of Application** English

**Filing Date** 2020-09-16

## APPLICANT AND AGENT DETAILS

### Applicant

Stafford-Miller (Ireland) Limited  
Clocherane, Youghal Road,  
Dungarvan  
Co. Waterford  
IRELAND

### Agent

BORDEN LADNER GERVAIS LLP  
World Exchange Plaza, 100 Queen Street,  
Suite 1300, Ottawa, ONTARIO, K1P1J9

## TRADEMARK DETAILS

### Trademark Type

Design

### Visual Representation

# BRUSH IN THE GOODNE

### Goods

#### Class 03

(1) Non medicated toilet preparations, namely, dentifrices, toothpaste, mouthwashes, breath fresheners, chewing gum for whitening teeth; Oral care preparations, namely, dental gels, tooth polishing preparations, tooth whitening preparations, cosmetic stain removal preparations; Bleaching preparations, namely, tooth whitening pastes, gels and creams, teeth whitening strips; Cosmetic teeth whitening strips impregnated with teeth whitening preparations.

#### Class 05

(2) Medicated oral care preparations, namely, medicated tooth whitening preparations, medicated mouth rinses, medicated mouth washes; Medicated tooth polishing preparations, namely, denture polishes, medicated tooth polish; Medicated bleaching preparation, namely, medicated tooth whitening preparations; Medicated chewing gum for cleaning and whitening teeth and for freshening breath; Medicated lozenges for freshening breath and moisturizing mouth.

#### Class 21

(3) Toothbrushes, toothpicks, dental floss, denture brushes

### Claims

Priority Filing Date: April 30, 2020, Country or Office: IRELAND, Application No: 2020/00677 in association with the same kind of goods

**Application Number** 2,073,420  
**International Registration Number** 1566240  
**Language of Application** English

**Filing Date** 2020-09-30

## APPLICANT AND AGENT DETAILS

### Applicant

GIORGIO ARMANI S.P.A.  
Via Borgonuovo, 11  
I-20121 MILANO (Milano)  
ITALY

### Agent

GOWLING WLG (CANADA) LLP  
SUITE 2600, 160 ELGIN STREET, OTTAWA,  
ONTARIO, K1P1C3

## TRADEMARK DETAILS

### Trademark Type

Design

### Visual Representation





### **Trademark Description**

The trademark consists of a stylized fantasy representation of the letter A.

### **Goods**

#### **Class 18**

(1) Handbags; traveling bags; briefcases; leather briefcases; leather credit card holders; wallets; leather document briefcases; key-cases of leather and skins; purses; suit cases; cosmetic bags sold empty; gym bags; evening and shoulder bags for ladies; leather shopping bags; school bags; garment bags for travel; suit carriers for travel; shoe bags for travel; beach bags; diaper bags; backpacks; Boston bags; traveling trunks; duffel bags; overnight bags; carry-on bags; satchels; opera bags, namely, bags for carrying opera glasses, bracelet bags, wristlet bags, evening bags, clutch bags; vanity cases, namely, cosmetic cases sold empty, beauty cases sold empty, make-up cases sold empty, toiletry cases sold empty, vanity cases sold empty; hides; cases and boxes made of leather; bags made of leather for packaging; leather straps; umbrellas; leather leashes; saddlery.

#### **Class 25**

(2) Coats; jackets; trousers; skirts; tops; raincoats; overcoats; belts; braces for clothing; suits; stuff jackets; jumpers; jeans; dresses; cloaks; parkas; shirts; T-shirts; sweaters; underwear; baby-dolls being nightwear; bathrobes; bathing costumes; negligee; swim suits; dressing gowns; shawls; neckerchiefs; scarves; ties; neckties; sweat shirts; under shirts; polo shirts; body suits; shorts; combinations [clothing], namely, track suits, business suits, jump suits, leisure suits; wedding dresses; stockings; socks; shoes; slippers; overshoes; galoshes; wooden clog; soles for footwear; footwear upper, namely, boot uppers, shoe uppers; boots; ski boots; snow boots; half boots; esparto shoes or sandals; sandals; bath sandals; gloves; mittens; hats and caps; visors (headwear).

**Application Number** 2,073,442  
**International Registration Number** 1566647  
**Language of Application** English

**Filing Date** 2020-10-10

## APPLICANT DETAILS

### Applicant

Shenzhen Geekvape Technology Co.,Ltd.  
A03,7th Floor, West Block,  
Laobing Hengfang Industry City,  
Xingye Road,Yongfeng community,  
Xixiang Sub-district, Baoan District  
518000 Shenzhen Guangdong  
CHINA

## TRADEMARK DETAILS

# OBELISK

### Trademark Type

Standard Characters

### Goods

#### Class 34

Cigarettes; electronic cigarettes; electronic cigarette liquid comprised of vegetable; flavourings other than essential oils for use in electronic cigarette; oral vaporizers for smokers; electric heaters for heating tobacco for the purpose of inhalation; cigarette tips; lighters for smokers; electronic cigarette cases; electronic cigarettes for use as an alternative to traditional cigarettes.



**Application Number** 2,074,060  
**Language of Application** English

**Filing Date** 2020-12-29

## APPLICANT DETAILS

### Applicant

Daqing Ruby Ice Cream Co.,Ltd  
Guangming Road Longfeng District  
Daqing City Heilongjiang Province,  
CHINA

## TRADEMARK DETAILS

### Trademark Type

Design

### Visual Representation

# 东北大板

### Foreign Character Translation

The translation provided by the applicant of the Chinese words DONG BEI DA BAN is EAST; NORTH; BIG; BOARD.

### Foreign Character Transliteration

The transliteration provided by the applicant of the Chinese characters is DONG BEI DA BAN .

### Goods

#### Class 30

bean meal; Chinese stuffed dumplings; Chinese stuffed dumplings (gyoza, cooked); dumpling skins; edible ices; flour-based dumplings; frozen confectionery; frozen yogurt cakes; frozen yogurt

confections; ice; ice cream; ice cream mixes; ices and ice creams; icing mixes; jiaozi [stuffed dumplings]; maize flakes; maize flour; maize meal; powders for making ice cream; rice; sherbets; soya flour; wheat germ for human consumption

**Application Number** 2,074,400  
**International Registration Number** 1568066  
**Language of Application** English

**Filing Date** 2020-09-16

## APPLICANT AND AGENT DETAILS

### Applicant

Cox Automotive, Inc  
6205 Peachtree Dunwoody Road  
Atlanta, GA 30328  
UNITED STATES OF AMERICA

### Agent

BORDEN LADNER GERVAIS LLP  
ATTN: INTELLECTUAL PROPERTY  
DEPARTMENT, 1000 DE LA GAUCHETIERE  
STREET WEST, SUITE 900, MONTREAL,  
QUEBEC, H3B5H4

## TRADEMARK DETAILS

# MANHEIM EXPRESS

### Trademark Type

Standard Characters

### Goods

#### Class 09

Downloadable mobile applications for use in providing auction services; downloadable mobile applications for use in providing a marketplace for buyers and sellers of vehicles and information about vehicles for sale, purchase, and auction; downloadable mobile application software for use in managing sales, purchases, auctions, and related transactions involving vehicles; downloadable software in the nature of a mobile application for facilitating transactions, namely, the sale and exchange of new and used vehicles between buyers and sellers through providing buyers with information about sellers, goods and services.

### Services

#### Class 36

(1) Insurance, motor vehicle financing services, providing information in the field of automobile financing, financing of cash advances, financial guarantee services, guarantee insurance services, vehicle warranty services, appraisals [valuation] of vehicles and information, advisory and consultancy services relating to all of the aforementioned services

#### Class 42

(2) Providing online non-downloadable software for use in providing auction services; providing online non-downloadable software featuring technology to facilitate and conduct vehicle auctions and purchase and sale transactions; providing online non-downloadable software for data analysis in the field of vehicle auctions and sales; providing online non-downloadable software for inventory management, vehicle valuations, vehicle auctions and sales, marketing information management, vehicle inspections, and monitoring and tracking of vehicle locations through a web operating system and portal interface.

### Claims

Priority Filing Date: March 16, 2020, Country or Office: EUIPO (EU), Application No: 018211140 in association with the same kind of goods and in association with the same kind of services

**Application Number** 2,074,447  
**International Registration Number** 1568409  
**Language of Application** English

**Filing Date** 2020-10-19

## APPLICANT AND AGENT DETAILS

### Applicant

Bay City Rollers Ltd  
27 Colinton Mains Crescent,  
Edinburgh Midlothian EH13 9DH  
UNITED KINGDOM

### Agent

HEER LAW  
25 Adelaide Street East, Suite 1000, Toronto,  
ONTARIO, M5C3A1

## TRADEMARK DETAILS

# BAY CITY ROLLERS

### Trademark Type

Standard Characters

### Trademark Description

It is a condition of registration that the mark shall be used in relation only to such services provided by members of the "Bay City Rollers" group.

### Authorisation For Use

Consent from the BAY CITY ROLLERS is of record.

### Services

#### Class 41

entertainment in the form of live performances by a musical band; entertainment services in the nature of recording, production and post-production services in the field of music;

**Application Number** 2,074,469  
**International Registration Number** 1429399  
**Language of Application** English

**Filing Date** 2020-10-26

## APPLICANT AND AGENT DETAILS

### Applicant

Porus GmbH  
Creative Campus Monheim Gebäude A01,  
Alfred-Nobel-Straße 10  
40789 Monheim  
GERMANY

### Agent

BORDEN LADNER GERVAIS LLP  
World Exchange Plaza, 100 Queen Street,  
Suite 1300, Ottawa, ONTARIO, K1P1J9

## TRADEMARK DETAILS

### Trademark Type

Design

### Visual Representation



### Colour Claim

Colour is claimed as a feature of the trademark. The colors blue, green and white are claimed as a feature of the mark. The mark consists of the stylized wording "ADD ONE" with the word "ADD" in white on a blue rectangular background and the wording "ONE" in white on a green rectangular background with a blue shaded circle in the middle of the "O".

### Goods

#### Class 05

(1) Dietetic foodstuffs and preparations for veterinary purposes, namely, animal feed additives; dietary supplements for animals, namely, animal feed supplements for veterinary purposes.

#### Class 29

(2) Meat; fish; poultry, not live; game; meat extracts; milk; milk products.

**Application Number** 2,074,597  
**International Registration Number** 1568002  
**Language of Application** English

**Filing Date** 2020-11-23

## APPLICANT AND AGENT DETAILS

### Applicant

Polyscope Polymers B.V.  
Prins de Lignestraat 28  
NL-6161 CZ Geleen  
NETHERLANDS

### Agent

SMART & BIGGAR LP  
1000 RUE DE LA GAUCHETIERE OUEST,  
BUREAU 3300, MONTREAL, QUEBEC,  
H3B4W5

## TRADEMARK DETAILS

# ORBISCOPE

### Trademark Type

Standard Characters

### Services

#### Class 35

(1) wholesale and retail store services in relation to chemicals for use in the chemical analysis industry, chemical manufacturing industry, biochemical manufacturing industry, pharmaceutical and cosmetics industry

#### Class 42

(2) chemical laboratories; chemical research; chemical analysis; research and development in the field of biochemistry and biotechnology; research and development in the field of protein characterization and isolation in the analytical, biochemical, pharmaceutical and cosmetics industry

### Claims

Priority Filing Date: August 03, 2020, Country or Office: Benelux Office for IP (BOIP), Application No: 1422387 in association with the same kind of services

**Application Number** 2,074,748  
**Language of Application** English

**Filing Date** 2020-12-31

## APPLICANT AND AGENT DETAILS

### Applicant

Shenzhen Datong World Technology Co., Ltd.  
Room 901, Block A, Phase I, Xinhua Building,  
Xinwei Village,  
Xili Street, Nanshan District,  
Shenzhen,  
CHINA

### Agent

MILTONS IP/P.I.  
#200-15 Fitzgerald Road, Ottawa, ONTARIO,  
K2H9G1

## TRADEMARK DETAILS

# Cestovet

### Trademark Type

Standard Characters

### Goods

#### Class 09

camcorders;car video recorders;DVD players;global positioning system (GPS) consisting of computers, computer software, transmitters, receivers, and network interface devices;wearable activity trackers;radar;audio cassette and CD players;inverters for power supply;tire pressure gauges;car broadcasting tuners

**Application Number** 2,075,721  
**International Registration Number** 1569496  
**Language of Application** English

**Filing Date** 2020-09-16

## APPLICANT AND AGENT DETAILS

### Applicant

Emrata Holdings, LLC  
16030 Ventura Blvd., Suite 240  
Encino CA 91436  
UNITED STATES OF AMERICA

### Agent

BERESKIN & PARR LLP/S.E.N.C.R.L., S.R.L.  
SCOTIA PLAZA, 40 KING STREET WEST,  
40th FLOOR, TORONTO, ONTARIO, M5H3Y2

## TRADEMARK DETAILS

### Trademark Type

Design

### Visual Representation

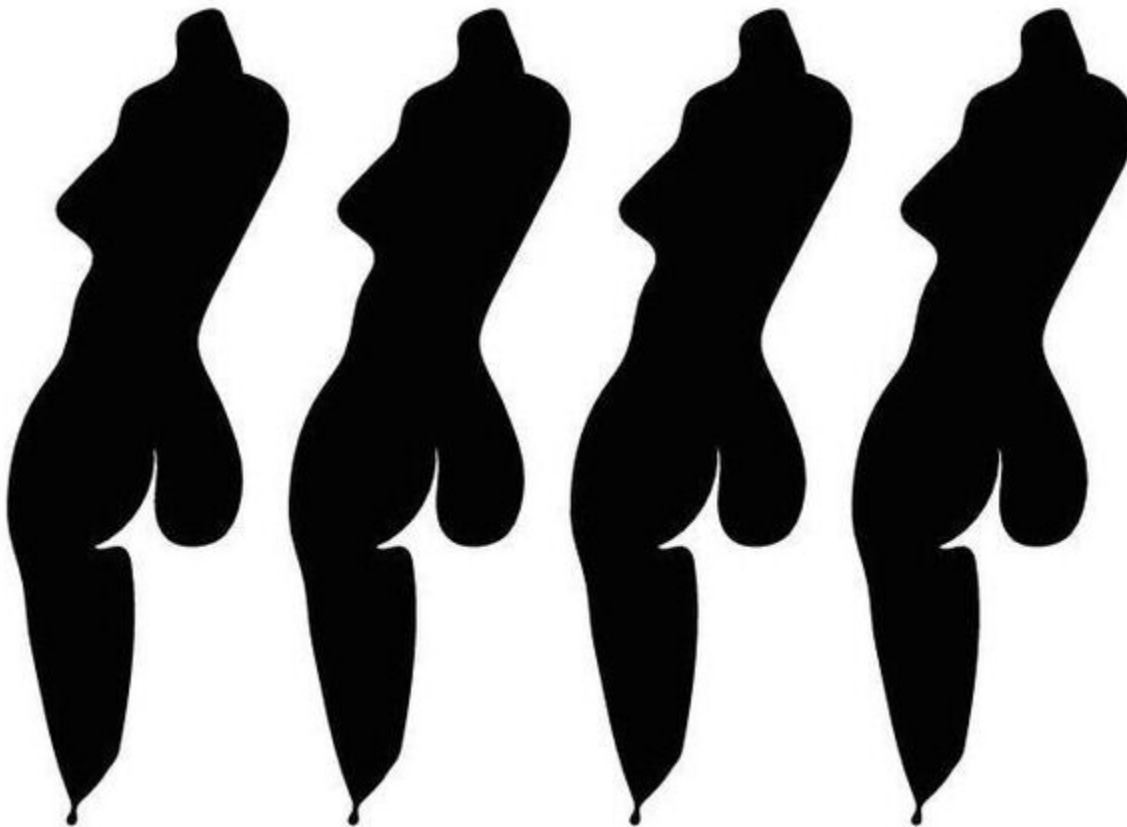

### Trademark Description

The mark consists of 4 repeating human figure block drawings.

### Goods

#### Class 25

Clothing, namely, shirts, sweaters, skirts, pants, shorts, leggings, dresses, bodysuits, rompers, sleepwear, beach coverups, robes, hoodies, jackets, coats, belts, scarves, lingerie, under



garments; headwear, namely hats, caps, head scarves, headbands; footwear, namely, socks, shoes, boots, sandals, slippers; swimwear.

**Claims**

Priority Filing Date: March 17, 2020, Country or Office: UNITED STATES OF AMERICA,  
Application No: 88838032 in association with the same kind of goods

**Application Number** 2,075,817  
**International Registration Number** 1569391  
**Language of Application** English

**Filing Date** 2020-10-15

## APPLICANT AND AGENT DETAILS

**Applicant**  
CELLTRION, INC.  
23, Academy-ro, Yeonsu-gu  
Incheon 22014  
REPUBLIC OF KOREA

**Agent**  
BERESKIN & PARR LLP/S.E.N.C.R.L., S.R.L.  
SCOTIA PLAZA, 40 KING STREET WEST,  
40th FLOOR, TORONTO, ONTARIO, M5H3Y2

## TRADEMARK DETAILS

# Remsimate

**Trademark Type**  
Standard Characters

### Goods

#### Class 09

Downloadable mobile application for setting, tracking, and monitoring health and wellness goals of users; downloadable software in the nature of a mobile application for providing medical, health and wellness information; downloadable computer software for providing medical, health and wellness information; computer application software for digital or electronic tablets for monitoring and tracking information for autoimmune disease management purposes; downloadable mobile application software for patient support in the field of autoimmune diseases; computer software for diagnosing diseases for medical purposes.

### Claims

Priority Filing Date: April 28, 2020, Country or Office: REPUBLIC OF KOREA, Application No: 4020200070929 in association with the same kind of goods

**Application Number** 2,076,016  
**International Registration Number** 1568663  
**Language of Application** French

**Filing Date** 2020-11-27

## APPLICANT AND AGENT DETAILS

**Applicant**  
FAMILLE MICHAUD APICULTEURS  
Domaine Saint Georges,  
Chemin de Berdoulou  
F-64290 GAN  
FRANCE

**Agent**  
ROBIC  
630, boul. René-Lévesque Ouest, 20e étage,  
Montréal, QUÉBEC, H3B1S6

## TRADEMARK DETAILS

**Trademark Type**  
Design

**Visual Representation**



**Goods**

**Class 05**

(1) Dietary supplements other than for medical use and intended exclusively for human consumption, namely vitamin and mineral supplements for overall health and wellness.

**Class 30**

(2) Honey, royal jelly for human consumption (other than for medical use), gingerbread; sweet confectionery; cakes; agave syrup for use as a natural sweetener; maple syrup; propolis; maple-flavoured simple syrup, maple butter, spread made from honey, maple syrup, agave syrup or coconut flower syrup; pastries, edible ices; natural sweeteners and sugars, in the nature of agave, maple and coconut flower powder.

**Class 32**

(3) Vegetable waters, namely birch water and maple water.

**Claims**

Priority Filing Date: May 27, 2020, Country or Office: EUIPO (EU), Application No: 018246074 in association with the same kind of goods

**Application Number** 2,076,104  
**International Registration Number** 1543065  
**Language of Application** English

**Filing Date** 2020-12-23

## APPLICANT AND AGENT DETAILS

### Applicant

Nagnata Pty Ltd  
1/67 Centennial Circuit  
Byron Bay NSW 2481  
AUSTRALIA

### Agent

OSLER, HOSKIN & HARCOURT LLP  
SUITE 6200, P.O. BOX 50, 1 FIRST  
CANADIAN PLACE, TORONTO, ONTARIO,  
M5X1B8

## TRADEMARK DETAILS

# NAGNATA

### Trademark Type

Standard Characters

### Goods

#### Class 25

Clothing, namely, tights, leggings, sports bras, socks, athletic shorts, jeans, jackets, shirts, t-shirts, coats, skirts, scarves, shawls, tops, pants, sweaters, hoodies, dresses and bodysuits; footwear, namely, shoes, boots, sneakers, slippers, sandals; headgear, namely, hats, caps, beanies, sun hats; underwear; sleepwear; lingerie; swimwear

### Claims

Priority Filing Date: July 01, 2020, Country or Office: AUSTRALIA, Application No: 2100168 in association with the same kind of goods

**Application Number** 2,076,437  
**Language of Application** French

**Filing Date** 2021-01-08

## APPLICANT DETAILS

### Applicant

Municipalité de L'Ange-Gardien  
1177, route 315  
L'Ange-Gardien  
QUÉBEC  
J8L0L4

## TRADEMARK DETAILS

# Champboisé

### Trademark Type

Standard Characters

### Services

#### Class 41

operation of botanical gardens; art exhibitions; gardens for public admission; arranging and conducting art exhibitions; arranging and conducting musical concerts; amusement parks; preparing audio-visual presentations

**Application Number** 2,076,994  
**Language of Application** English

**Filing Date** 2021-01-12

## APPLICANT AND AGENT DETAILS

### Applicant

Well Told Inc.  
200-99 Yorkville Ave  
Toronto  
ONTARIO  
M5R3K5

### Agent

DLA PIPER (CANADA) LLP  
1 FIRST CANADIAN PLACE, SUITE 6000, P.  
O. BOX 367, 100 KING STREET WEST,  
TORONTO, ONTARIO, M5X1E2

## TRADEMARK DETAILS

# BLOATING BE GONE

### Trademark Type

Standard Characters

### Goods

#### Class 05

dietary supplements for general health and well-being; herbal supplements for general health and well-being; nutritional supplements for general health and well-being; vitamins;

**Application Number** 2,077,235  
**Language of Application** English

**Filing Date** 2021-01-13

## APPLICANT AND AGENT DETAILS

### Applicant

Chase Pecan, LP  
2803 W. Wallace Street  
San Saba, TX 76877  
UNITED STATES OF AMERICA

### Agent

GOWLING WLG (CANADA) LLP  
550 BARRARD STREET, SUITE 2300,  
VANCOUVER, BRITISH COLUMBIA, V6C2B5

## TRADEMARK DETAILS

# PECANA

### Trademark Type

Standard Characters

### Goods

#### Class 29

Nut milk

### Claims

Priority Filing Date: September 15, 2020, Country or Office: UNITED STATES OF AMERICA,  
Application No: 90/182,952 in association with the same kind of goods



**Application Number** 2,078,836  
**International Registration Number** 1571489  
**Language of Application** English

**Filing Date** 2020-10-30

## APPLICANT AND AGENT DETAILS

### Applicant

Ningbo Xichuang Nike Electronic Technology  
Co., Ltd  
Wangjia qiao Village, Dong qiao Town,  
Hai shu District, Ningbo City  
315000 Zhejiang Province  
CHINA

### Agent

JERRY CHEN  
JZC Intellectual Property Law, 166 Berwick  
Cres, Richmond Hill, ONTARIO, L4C0B4

## TRADEMARK DETAILS

### Trademark Type

Design

### Visual Representation

The logo consists of the word "COSMICONI" in a bold, italicized, sans-serif font. The letters are black with a white outline, giving it a three-dimensional appearance. The 'O's are particularly large and stylized.

### Goods

#### Class 09

data transmission cables; interfaces for computers; audio cables; cables, electric; coaxial cables; fibre-optic cables; printed circuits; fiber optic couplings; wires, electric; electric plug.

**Application Number** 2,078,837  
**International Registration Number** 1571084  
**Language of Application** English

**Filing Date** 2020-11-02

## APPLICANT AND AGENT DETAILS

### Applicant

KUKANKEIKAKU CO.,LTD  
1-6, Kita 3-jo Nishi 23-chome,  
Chuo-ku,  
Sapporo-shi  
Hokkaido 064-0823  
JAPAN

### Agent

SMART & BIGGAR LP  
1100-150 York street, TORONTO, ONTARIO,  
M5H3S5

## TRADEMARK DETAILS

### Trademark Type

Design

### Visual Representation

# SavvySensei

### Services

#### Class 38

(1) Providing multiple users access to a global computer network; personal communication services using computer terminals; providing internet chatrooms; teleconferencing services; providing online forums in the fields of Japanese cuisine, food, food ingredients specially used in preparing Japanese food and cuisine, cooking utensils, restaurants, cooking, etiquette, Japanese table manners and culture; communications by cellular phones; electronic exchange of messages using chat lines, chatrooms and Internet forums; wireless electronic transmission of voice messages, facsimiles, text messages, streaming video, movies, music, photographs and digital images in the fields of Japanese cuisine, food, food ingredients specially used in preparing Japanese food and cuisine, cooking utensils, restaurants, cooking, etiquette, Japanese table manners and culture; mobile media services for providing video streaming content through mobile applications; streaming of audio and video via the internet featuring Japanese food, cooking, and culture; providing access to databases; email transmission of data and documents via computer terminals; electronic transmission of digital photo files via a peer-to-peer network; providing access to Internet platforms for the purpose of exchanging digital photographs; providing telecommunications connections to a global computer network; providing user access to global computer networks; rental of access time to global computer networks; electronic bulletin board services; transmission of electronic mail; video-on-demand transmission; videoconferencing

services; transmission of podcasts about Japanese food, cooking, and culture; radio broadcasting services; digital text messaging; transmission, broadcasting and reception of music, video, digital photographs, movies, text messages.

### **Class 41**

(2) Teaching in the fields of Japanese cuisine, food, food ingredients specially used in preparing Japanese food and cuisine, cooking utensils, restaurants, cooking, etiquette, Japanese table manners and culture; educational services, namely, developing curriculum for others in the fields of Japanese cuisine, food, food ingredients specially used in preparing Japanese food and cuisine, cooking utensils, restaurants, cooking, etiquette, Japanese table manners and culture; educational services relating to Japanese cuisine; academic examination services in the field of cooking; providing information in the field of culinary education; coaching in the fields of Japanese cuisine, food, food ingredients specially used in preparing Japanese food and cuisine, cooking utensils, restaurants, cooking, etiquette, Japanese table manners and culture; tutoring; cooking instruction; arranging, conducting and organization of seminars in the field of Japanese cuisine, food, food ingredients specially used in preparing Japanese food and cuisine, cooking utensils, restaurants, cooking, etiquette, Japanese table manners and culture; providing online electronic publications, not downloadable, namely newsletters, blogs and articles in the fields of Japanese cuisine, food, food ingredients specially used in preparing Japanese food and cuisine, cooking utensils, restaurants, cooking, etiquette, Japanese table manners and culture; electronic desktop publishing; providing videos from the internet, not downloadable; providing motion pictures from the internet, not downloadable; providing online videos, not downloadable; production and provision of downloadable audio and video recordings via a website in the fields of Japanese cuisine, food, food ingredients specially used in preparing Japanese food and cuisine, cooking utensils, restaurants, cooking, etiquette, Japanese table manners and culture; production of videotape film in the field of education, culture, entertainment or sports [not for movies or television programs and not for advertising or publicity]; party planning [entertainment]; consultancy relating to the organization of culinary competitions; language interpretation; language interpreter services; translation; video editing services for events; entertainment services in the nature of cooking clubs; social club services, namely, arranging, organizing, and hosting social events, get-togethers, parties and online social entertainment events in the fields of Japanese cuisine, food, food ingredients specially used in preparing Japanese food and cuisine, cooking utensils, restaurants, cooking, etiquette, Japanese table manners and culture for club members; online membership club services, namely, providing on-line non-downloadable videos, tutorial sessions, non-downloadable tutorial videos, and blogs in the fields of Japanese cuisine, food, food ingredients specially used in preparing Japanese food and cuisine, cooking utensils, restaurants, cooking, etiquette, Japanese table manners and culture; providing user ratings of Japanese restaurants and stores featuring Japanese food, groceries and cooking utensils, for entertainment and cultural purposes; providing user rankings of Japanese restaurants and stores featuring Japanese food, groceries and cooking utensils, for entertainment and cultural purposes; providing user reviews of Japanese restaurants and stores featuring Japanese food, groceries and cooking utensils, for entertainment and cultural purposes.

### **Claims**

Priority Filing Date: July 22, 2020, Country or Office: JAPAN, Application No: 2020-091187 in association with the same kind of services

**Application Number** 2,078,872  
**International Registration Number** 1571079  
**Language of Application** English

**Filing Date** 2020-11-13

## APPLICANT AND AGENT DETAILS

### Applicant

DK Universe Limited  
Preston Park House, South Road  
Brighton, East Sussex BN1 6SB  
UNITED KINGDOM

### Agent

CATHERINE M. DENNIS BROOKS  
(MILLER THOMSON LLP), SCOTIA PLAZA,  
40 KING STREET WEST, TORONTO,  
ONTARIO, M5H3S1

## TRADEMARK DETAILS

### Trademark Type

Design

### Visual Representation



### Colour Claim

Colour is claimed as a feature of the trademark. The color(s) black, purple, and white is/are claimed as a feature of the mark. The mark consists of the stylized wording "TGB ACADEMY" the letters "T" and "B" appear in black; the letter "G" is black with the cross bar portion created by a purple rectangle with the white stylized wording "ACADEMY" appearing within the purple rectangle.

### Services

#### Class 41

Education, teaching and training relating to nail strengtheners, builder gels for nails, nail building gels, nail strengthening gels, gel overlays for nails, nail hardeners, nail gels, nail tips, nail cream,

nail polish, nail varnish, nail makeup and nail cosmetics; providing training in the field of cosmetic nail care preparations and nail care services; training courses in the field of cosmetic nail care preparations and nail treatment services; education and training in the nature of courses, seminars, and workshops in the field of cosmetic nail care preparations and nail care services; education, teaching and training in the nature of courses, seminars, and workshops in the field of nail care preparations and nail care services; education and training consultancy in the field of cosmetic nail care preparations and nail care services; training and education services, namely courses, seminars, and workshops in the field of cosmetic nail care preparations and nail care services; educational and training services namely courses, seminars, and workshops in the field of cosmetic nail care preparations and nail care services; provision of training and education namely courses, seminars, and workshops in the field of cosmetic nail care preparations and nail care services; vocational education and training services in the field of cosmetic nail care preparations and nail care services; publication of educational and training guides in the field of cosmetic nail care preparations and nail care services; provision of information and preparation of progress reports relating to education and training in the field of cosmetic nail care preparations and nail treatment services; consultancy services relating to the education and training of management and of personnel in the field of cosmetic nail care preparations and nail care services; conducting of instructional, educational and training courses for young people and adults in the field of cosmetic nail care preparations and nail care services; provision of training information and training consultancy services relating to nail strengtheners, builder gels for nails, nail building gels, nail strengthening gels, gel overlays for nails, nail hardeners, nail gels, nail tips, nail cream, nail polish, nail varnish, nail makeup and nail cosmetics.

**Claims**

Priority Filing Date: May 28, 2020, Country or Office: UNITED KINGDOM, Application No: UK00003494397 in association with the same kind of services

**Application Number** 2,078,874  
**International Registration Number** 1571703  
**Language of Application** English

**Filing Date** 2020-11-13

## APPLICANT AND AGENT DETAILS

### Applicant

DK Universe Limited  
Preston Park House, South Road  
Brighton, East Sussex BN1 6SB  
UNITED KINGDOM

### Agent

CATHERINE M. DENNIS BROOKS  
(MILLER THOMSON LLP), SCOTIA PLAZA,  
40 KING STREET WEST, TORONTO,  
ONTARIO, M5H3S1

## TRADEMARK DETAILS

### Trademark Type

Design

### Visual Representation





### **Colour Claim**

Colour is claimed as a feature of the trademark. The color(s) pink and white is/are claimed as a feature of the mark. The mark consists of a pink stylized triangular design with the white stylized wording "THE GEL BOTTLE INC." appearing within.

### **Goods**

#### **Class 03**

Nail strengtheners; builder gels for nails; nail building gels; nail strengthening gels; gel overlays for nails; nail hardeners; nail gel; nail tips; nail cream; nail enamel; nail polish; nail varnish; nail whiteners; nail makeup; nail cosmetics; nail conditioners; nail glitter; false nails; artificial nails; nail care preparations; nail buffing preparations; cosmetic nail preparations; gel nail removers; nail polishing powder; nail primer [cosmetics]; nail enamel removers; nail polish remover; nail varnish removers; nail hardeners [cosmetics]; nail art stickers; nail paint [cosmetics]; nail polish pens; nail base coat [cosmetics]; cosmetic nail care preparations; nail varnish removing preparations; nail polish top coat; nail polish base coat; nail polish remover pens; adhesives for artificial nails; glue for strengthening nails; cosmetic preparations for nail drying; nail varnish for cosmetic purposes; adhesives for fixing false nails; adhesives for affixing false nails; preparations for reinforcing the nails; artificial nails for cosmetic purposes; preparations for removing gel nails; lotions for strengthening the nails; powder for forming sculpted finger nail tips.

### **Services**

#### **Class 41**

Education, teaching and training relating to nail strengtheners, builder gels for nails, nail building gels, nail strengthening gels, gel overlays for nails, nail hardeners, nail gels, nail tips, nail cream, nail polish, nail varnish, nail makeup and nail cosmetics; providing training in the field of cosmetic nail care preparations and nail care services; training courses in the field of cosmetic nail care preparations and nail treatment services; education and training in the nature of courses, seminars, and workshops in the field of cosmetic nail care preparations and nail care services; education, teaching and training in the nature of courses, seminars, and workshops in the field of nail care preparations and nail care services; education and training consultancy in the field of cosmetic nail care preparations and nail care services; training and education services, namely courses, seminars, and workshops in the field of cosmetic nail care preparations and nail care services; educational and training services namely courses, seminars, and workshops in the field of cosmetic nail care preparations and nail care services; provision of training and education namely courses, seminars, and workshops in the field of cosmetic nail care preparations and nail care services; vocational education and training services in the field of cosmetic nail care preparations and nail care services; publication of educational and training guides in the field of cosmetic nail care preparations and nail care services; provision of information and preparation of

progress reports relating to education and training in the field of cosmetic nail care preparations and nail treatment services; consultancy services relating to the education and training of management and of personnel in the field of cosmetic nail care preparations and nail care services; conducting of instructional, educational and training courses for young people and adults in the field of cosmetic nail care preparations and nail care services; provision of training information and training consultancy services relating to nail strengtheners, builder gels for nails, nail building gels, nail strengthening gels, gel overlays for nails, nail hardeners, nail gels, nail tips, nail cream, nail polish, nail varnish, nail makeup and nail cosmetics.

**Claims**

Priority Filing Date: May 28, 2020, Country or Office: UNITED KINGDOM, Application No: UK00003494395 in association with the same kind of goods and in association with the same kind of services



**Application Number** 2,078,891  
**International Registration Number** 1571181  
**Language of Application** English

**Filing Date** 2020-11-23

## **APPLICANT AND AGENT DETAILS**

**Applicant**  
SICHUAN YIBIN WULIANGYE GROUP CO.,  
LTD  
#150, Minjiang West Road, Yibin  
Sichuan  
CHINA

**Agent**  
NEOMARK LTD.  
7450 rue Saint-Hubert, Montréal, QUEBEC,  
H2R2N3

## **TRADEMARK DETAILS**

**Trademark Type**  
Design

**Visual Representation**



**Trademark Description**

The mark consists of an outer circle with an inner circle enclosing a letter "W" and five rays emanating from the top center of the outer circle toward the bottom half of the outer circle.

**Services****Class 43**

Hotel services; tourist home services; retirement home services; rental of chairs, tables, table linen, glassware; day-nursery services; hotel room reservation services; hotel accommodation services; pet hotel services; hotel catering services; café services.

**Application Number** 2,078,894  
**International Registration Number** 1571430  
**Language of Application** English

**Filing Date** 2020-11-23

## APPLICANT AND AGENT DETAILS

### Applicant

Sichuan Yibin Wuliangye Group Co., Ltd  
#150, Minjiang West Road,  
Yibin  
Sichuan  
CHINA

### Agent

NEOMARK LTD.  
7450 rue Saint-Hubert, Montréal, QUEBEC,  
H2R2N3

## TRADEMARK DETAILS

### Trademark Type

Design

### Visual Representation

五糧液大酒家

### Trademark Description

The mark consists of five Chinese characters.

### Foreign Character Translation

The translation provided by the applicant of the Chinese word(s) WU LIANG YE DA JIU JIA is "five", "grain", "liquid", "big", "liquor" and "home".

### Foreign Character Transliteration

The transliteration provided by the applicant of the Chinese character(s) is WU LIANG YE DA JIU JIA.

### Services

#### Class 35

Advertising agencies; presentation of goods for others via the internet, for retail purposes; organization of trade fairs for commercial and advertising purposes of a variety of goods for others; organization of exhibitions for commercial and advertising purposes of a variety of goods for others; business management of hotels; business management assistance; commercial administration of the licensing of the goods and services of others; import-export agency services; direct marketing of the goods and services of others; promoting the goods and services of others through advertisements on Internet websites.

**Application Number** 2,079,270  
**Language of Application** English

**Filing Date** 2021-01-21

## **APPLICANT DETAILS**

### **Applicant**

kim bettez  
560 Av Claremont  
Westmount  
QUEBEC  
H3Y2P1

## **TRADEMARK DETAILS**

# **Lele de Baltzac**

### **Trademark Type**

Standard Characters

### **Goods**

#### **Class 25**

casual clothing

### **Services**

#### **Class 35**

consignment sale of clothing

**Application Number** 2,080,067  
**Language of Application** English

**Filing Date** 2021-01-27

## APPLICANT AND AGENT DETAILS

### Applicant

Shanghai Yuhai Clothing Co., Ltd.  
Block C, Room 386, No. 103, Nantang Bang  
Road, Huangpu District,  
Shanghai, 200000  
CHINA

### Agent

NEOMARK LTD.  
7450 rue Saint-Hubert, Montréal, QUEBEC,  
H2R2N3

## TRADEMARK DETAILS

### Trademark Type

Design

### Visual Representation

The image shows the trademark '13 DE MARZO' in a highly stylized, outlined font. The characters are thick and have a decorative, calligraphic feel. The '1' is a simple vertical line. The '3' has a large, ornate loop at the bottom. The 'D' is a simple block letter. The 'E' has a decorative flourish on its right side. The 'M' is a simple block letter. The 'A' has a decorative flourish on its left side. The 'R' is a simple block letter. The entire logo is rendered in black outlines on a white background.

### Foreign Character Translation

The translation provided by the applicant of the Spanish word(s) 13 DE MARZO is MARCH 13.

### Goods

#### Class 25

baby clothing; coats; dress clothing; gloves; hats; hosiery; scarves; shoes; trench coats; trousers

**Application Number** 2,080,329  
**International Registration Number** 1572608  
**Language of Application** English

**Filing Date** 2020-11-04

## APPLICANT AND AGENT DETAILS

### Applicant

Flynn & Flynn Global Trade Ltd.  
Creowen Road, Kilcoole Industrial Estate  
Kilcoole, Co Wicklow  
IRELAND

### Agent

GOWLING WLG (CANADA) LLP  
TD Canada Trust Tower, Suite 1600, 421 -7  
Avenue SW, Calgary, ALBERTA, T2P4K9

## TRADEMARK DETAILS

### Trademark Type

Design

### Visual Representation



### Colour Claim

Colour is claimed as a feature of the trademark. The pears are in yellow and orange hues, with green leaves. The person on the left pear has a blue shirt and orange pants. The handstanding person has an orange shirt and blue pants. The words "The Happy Pear" are orange.

### Services

#### Class 35

(1) Retail services for foodstuffs and beverages.

#### Class 41

(2) Educational and instructional services, namely, food preparation and cookery courses and dietary and lifestyle advice in the nature of life coaching to encourage general healthy lifestyles; production of television and other media shows, namely, video podcasts and blogs in the field of cooking instructions and nutrition via the Internet and social media platforms; providing electronic publications in the nature of periodicals, newsletters, and books not downloadable, from the Internet; Publishing of books and magazines; production of stage shows; providing entertainment via podcasts; arranging and conducting of seminars and conferences in the fields of nutrition and cooking through a website; providing non-downloadable videos, images, and audio-visual content featuring, films, radio and television programmes via the Internet.

**Application Number** 2,080,382  
**International Registration Number** 1572212  
**Language of Application** English

**Filing Date** 2020-11-23

## APPLICANT AND AGENT DETAILS

### Applicant

Sichuan Yibin Wuliangye Group Co., Ltd  
#150, Minjiang West Road,  
Yibin  
Sichuan  
CHINA

### Agent

NEOMARK LTD.  
7450 rue Saint-Hubert, Montréal, QUEBEC,  
H2R2N3

## TRADEMARK DETAILS

### Trademark Type

Design

### Visual Representation

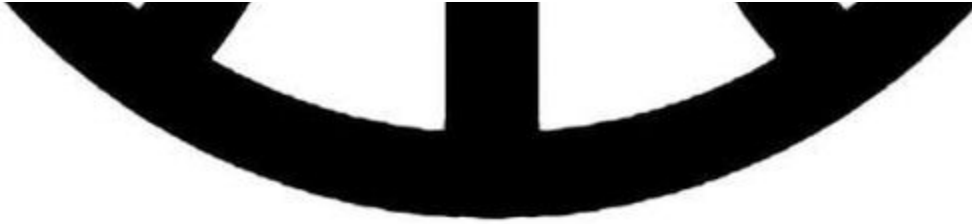

**Trademark Description**

The mark consists of an outer circle with an inner circle enclosing a letter "W" and five rays emanating from the top center of the outer circle toward the bottom half of the outer circle.

**Goods****Class 32**

Beer; mineral water [beverages]; drinking waters; non-alcoholic fruit extracts; isotonic beverages; vegetable juices [beverages]; beer wort.



**Application Number** 2,080,526  
**International Registration Number** 1259979  
**Language of Application** English

**Filing Date** 2020-12-24

## APPLICANT AND AGENT DETAILS

### Applicant

Antal International Limited  
Second Floor,  
64,  
Baker Street  
London W1U 7GB  
UNITED KINGDOM

### Agent

MCDERMID TURNBULL & ASSOCIATES  
P.O. Box 40516, Kirkland, QUEBEC, H9H5G8

## TRADEMARK DETAILS

### Trademark Type

Design

### Visual Representation



**Trademark Description**

ANTAL.

**Colour Claim**

Colour is claimed as a feature of the trademark. The letters "Ant" and the upper left tail of the inner circle and the tail at the bottom of the outer circle design are Pantone 2597C. The letters "al" and top portion middle of the circle and middle right of circle are Pantone 238C. The upper right portion of the circle are Pantone 185C, Pantone 1375C and Pantone 7405C. The middle inner bottom portion of the circle is Pantone 349C. The upper left side tail of the outer circle is Pantone 360C. The bottom right tail of the inner circle is Pantone 3425C. Pantone is a registered trademark.

**Goods****Class 16**

Printed publications, namely, product brochures, magazines, books, periodicals, newsletters, printed instructional, educational and teaching manuals, instructional learning notes, all in the field of business management, personnel placement and recruitment, human resources, executive recruitment, business administration; Promotional items, namely, note paper, paper, pencils, pens, posters

**Services****Class 35**

Assistance in business management within the framework of a franchise contract; business management and advice; personnel placement and recruitment; business recruitment consultancy; executive recruitment services; business management consulting; business administration

**Application Number** 2,080,527  
**International Registration Number** 0777178  
**Language of Application** English

**Filing Date** 2020-12-24

## APPLICANT AND AGENT DETAILS

### Applicant

ANTAL INTERNATIONAL LIMITED  
(COMPANY NO: 06020652)  
Second Floor, 64 Baker Street  
LONDON W1U 7GB  
UNITED KINGDOM

### Agent

MCDERMID TURNBULL & ASSOCIATES  
P.O. Box 40516, Kirkland, QUEBEC, H9H5G8

## TRADEMARK DETAILS

### Trademark Type

Design

### Visual Representation

**ANTAL**

### Goods

#### Class 16

Printed publications, namely, product brochures, magazines, books, periodicals, newsletters, printed instructional, educational and teaching manuals, instructional learning notes, all in the field of business management, personnel placement and recruitment, human resources, executive recruitment, business administration; Promotional items, namely, note paper, paper, pencils, pens, posters

### Services

#### Class 35

Business management; business administration; global management recruitment services; placement of temporary and permanent employees/consultants including overseas placements and the provision of related information pursuant to such placements

**Application Number** 2,080,534  
**International Registration Number** 0565211  
**Language of Application** French

**Filing Date** 2021-01-12

## APPLICANT AND AGENT DETAILS

### Applicant

GROUPEMENT FONCIER AGRICOLE DU  
CHATEAU GRAND PUY LACOSTE  
Château Grand Puy Lacoste,  
BP 82  
F-33250 PAUILLAC  
FRANCE

### Agent

LJT LAWYERS, LLP / LJT AVOCATS, S.E.N.C.  
R.L.  
7100-380 rue Saint-Antoine O, Montréal,  
QUÉBEC, H2Y3X7

## TRADEMARK DETAILS

### Trademark Type

Design

### Visual Representation

**GRAND PUY LAC**

### Goods

Class 33

Wines.

**Application Number** 2,080,536  
**International Registration Number** 1560882  
**Language of Application** English

**Filing Date** 2021-01-12

## APPLICANT AND AGENT DETAILS

### Applicant

Graspointner Holding GmbH  
Gessenschwandt 39  
A-4882 Oberwang  
AUSTRIA

### Agent

BHOLE IP LAW  
130 Queens Quay East, Suite 1214, Toronto,  
ONTARIO, M5A0P6

## TRADEMARK DETAILS

### Trademark Type

Design

### Visual Representation

**BG-FILCOTEN**

### Colour Claim

Colour is claimed as a feature of the trademark. The part of the mark "BG-" is black. The letters "FILCOTEN" are green. The background is white

### Goods

#### Class 06

(1) Metal building materials, namely, rain gutter screens made of metal fabrics, meshes and grids, metal drainpipes and metal gutters, metal rainspouts; drainage channels of metal; drain connections of metal

#### Class 19

(2) Non-metallic building materials, namely, non-metallic reinforcements for concrete, namely, plastic plates, glass and plastic fibers, plastic rods, plastic bars, plastic gutter grates consisting of plastic rods and plastic bars, and accessory products made of plastic for plastic gutter grates, namely, plastic plates and plastic buckets for drainage; drainage channels of concrete, drainage channels consisting of non-metal fibre-reinforced concrete, non-metal fibre-reinforced casting materials; non-metallic building materials, namely, drain connections for gutter systems and rainspouts; non-metallic rigid pipes for building, namely, for use with gutter drainage systems

**Application Number** 2,081,595  
**Language of Application** English

**Filing Date** 2021-02-02

## **APPLICANT DETAILS**

### **Applicant**

Ashley Mooney  
17 Pomona Ave.  
Oromocto  
NEW BRUNSWICK  
E2V1W9

## **TRADEMARK DETAILS**

### **Trademark Type**

Design

### **Visual Representation**

*Ashley Nicole*

### **Goods**

**Class 25**

bridal wear

**Application Number** 2,081,902  
**International Registration Number** 1573649  
**Language of Application** English

**Filing Date** 2020-07-10

## APPLICANT AND AGENT DETAILS

### Applicant

Unit4 Group Holding B.V.  
Stationspark 1000  
NL-3364 DA Sliedrecht  
NETHERLANDS

### Agent

RIDOUT & MAYBEE LLP  
250 University Avenue, 5th Floor, Toronto,  
ONTARIO, M5H3E5

## TRADEMARK DETAILS

# UNIT4 EXPERIENCE 4U

### Trademark Type

Standard Characters

### Goods

#### Class 09

Business computer software for use in business analysis, audit planning, sales management, financial performance reporting, cash flow planning, statutory reporting, account analysis and human resources management; business software packages namely software suites providing an organized collection of multiple packages comprised of software for use in business analysis, audit planning, sales management, financial performance reporting, cash flow planning, statutory reporting, account analysis and human resources management; computer software platforms, downloadable for use in business analysis, audit planning, recurring finance, control and audit processes, sales management, financial performance reporting; interactive business software for use in business analysis, audit planning, sales management, financial performance reporting, cash flow planning, statutory reporting, account analysis and human resources management; business software downloadable from the internet for use in business analysis, audit planning, sales management financial performance reporting, cash flow planning, statutory reporting, account analysis and human resources management; downloadable cloud business software for use in business analysis, audit planning, sales management, financial performance reporting, cash flow planning, statutory reporting, account analysis and human resources management; ERP (enterprise resource planning) software; computer application software, namely apps, for mobile phones, tablets and computers for use for business and ERP (enterprise resource planning) software in the field of business analysis, audit planning, sales management, financial performance reporting, cash flow planning, statutory reporting, account analysis and human resources management.

### Services

#### Class 42

Developing business software; developing ERP software; advising on business software; installation, implementation and maintenance of business software; developing computer software and software as a service [SaaS] featuring software for use in business analysis, audit planning, sales management, financial performance reporting, cash flow planning, statutory reporting,

account analysis and human resources management; developing and providing non-downloadable cloud computer software services for use in business analysis, audit planning, sales management, financial performance reporting, cash flow planning, statutory reporting, account analysis and human resources management; developing computer software and platform as a service [PaaS] featuring computer software platforms for use in the field of business analysis, audit planning, sales management, financial performance reporting, cash flow planning, statutory reporting, account analysis and resources management; developing software applications for mobile phones, tablets and computers.

**Claims**

Priority Filing Date: January 16, 2020, Country or Office: Benelux Office for IP (BOIP), Application No: 01409579 in association with the same kind of goods and in association with the same kind of services



**Application Number** 2,081,943  
**International Registration Number** 1573207  
**Language of Application** English

**Filing Date** 2020-09-17

## APPLICANT AND AGENT DETAILS

### Applicant

Widex A/S  
Nymoellevej 6  
DK-3540 Lynge  
DENMARK

### Agent

CLARK WILSON LLP  
900 - 885 WEST GEORGIA STREET,  
VANCOUVER, BRITISH COLUMBIA, V6C3H1

## TRADEMARK DETAILS

# ZERODELAY

### Trademark Type

Standard Characters

### Goods

#### Class 10

Medical devices, namely, medical apparatus and instruments for use by and in connection with persons with defective hearing in the nature of hearing aids, and parts and accessories for hearing aids in the nature of wireless transmitters and receivers for use with hearing aids.

**Application Number** 2,082,053  
**International Registration Number** 1573461  
**Language of Application** English

**Filing Date** 2020-11-19

## APPLICANT AND AGENT DETAILS

**Applicant**  
FREEWILL SPORTS PVT LTD.  
S-32, 33 Industrial Area  
Jalandhar 144004  
INDIA

**Agent**  
WILSON LUE LLP  
250 University Avenue, 5th Floor, Toronto,  
ONTARIO, M5H3E5

## TRADEMARK DETAILS

# NIVIA

**Trademark Type**  
Standard Characters

**Goods**

**Class 28**

backboards for basketball; bags adapted for soccer balls; balls for games; basketball goals; basketball hoops; basketball nets; chest expanders; cricket bats; cricket practice nets; dumb-bells; elbow guards for sports use; exercise bars; exercise weights; football field markers; football goals; goals for soccer; knee guards for sports use; leg weights for exercise; nets for soccer goals; protective padding for playing sports; soccer backboards; soccer disc cones; sport gloves; stationary exercise bicycles; volleyball equipment; volleyball nets; volleyball standards; weight lifting machines;

**Application Number** 2,082,054  
**International Registration Number** 1573320  
**Language of Application** English

**Filing Date** 2020-11-19

## APPLICANT AND AGENT DETAILS

### Applicant

FREEWILL SPORTS PVT LTD.  
s-32, 33 Industrial Area  
Jalandhar 144004  
INDIA

### Agent

WILSON LUE LLP  
250 University Avenue, 5th Floor, Toronto,  
ONTARIO, M5H3E5

## TRADEMARK DETAILS

# NIVIA

### Trademark Type

Standard Characters

### Goods

#### Class 25

Sportswear and sports shoes.

**Application Number** 2,082,094  
**International Registration Number** 1573920  
**Language of Application** English

**Filing Date** 2020-11-30

## APPLICANT AND AGENT DETAILS

### Applicant

LORO PIANA S.p.A.  
Corso Rolandi, 10  
I-13017 Quarona (VC)  
ITALY

### Agent

RIDOUT & MAYBEE LLP  
250 University Avenue, 5th Floor, Toronto,  
ONTARIO, M5H3E5

## TRADEMARK DETAILS

### Trademark Type

Design

### Visual Representation



**Goods****Class 18**

(1) Leather and imitations of leather; trunks and suitcases; umbrellas and parasols; whips, harness and saddlery; clothing for pets; saddlery; key cases; vanity cases, not fitted; travelling trunks; all purpose carrying bags; slings for carrying infants; bags for sports; chain mesh purses; purses; handbags; leather travelling bags; briefcases; school bags; furs; horse blankets; moleskin being imitation of leather; umbrella covers; leather leashes; imitation leather; suitcase handles; pouch baby carriers; parasols; umbrellas; animal skins, hides; card cases [notecases]; music cases; pocket wallets; furniture coverings of leather; beach bags; travelling bags; wheeled shopping bags; leather or leather-board boxes; hat boxes of leather; valises; attaché cases; briefcases; garment bags for travel; rucksacks.

**Class 25**

(2) Neck tube scarves [mufflers]; ear muffs [clothing]; layettes [clothing]; corselets; corsets, stockings; coats; shirts; suits; beach clothes; masquerade costumes; neckties; ascots; bathing caps; shower caps; headbands [clothing]; pocket squares; scarves; fittings of metal for footwear; ready-made linings for coats, dresses, skirts, pants; overcoats; spats; jackets [clothing]; fishing vests; garters; skirts; jumper dresses; aprons [clothing]; girdles; gloves [clothing]; mittens; ski gloves; welts for footwear; waterproof clothing, namely, jackets, rain pants; paper casual clothing; knitwear [clothing], namely, sweaters, jackets, skirts, pants, tops; jerseys [clothing]; leggings [trousers]; liveries; hosiery; swimsuits; sweaters; hand muffs; maniples; pelerines; mantillas; sleep masks; miniskirts; miters being hats; pants; bathing trunks; waistcoats; babies' pants [clothing]; trousers; parkas; pelisses; fur clothing, namely, hats, coats, muffs, gloves; shirt yokes; pyjamas; dressing gowns; cuffs; ponchos; sweaters; tips for footwear; stocking suspenders; sock suspenders; brassieres; heelpieces for footwear; heelpieces for stockings; sandals; bath sandals; saris; sarongs; shoes; esparto shoes or sandals; bath sandals; gymnastic shoes; beach shoes; football boots; sports shoes; ski boots; slippers; deck shoes; shawls; scarves; underpants; lace boots; wimples; topcoats; outerwear jackets; dress shields; trouser straps; petticoats; slips [undergarments]; shirt fronts; half-boots; boots; boots for sports; fur stoles; soles for footwear; inner soles; heels; pockets for clothing; tee-shirts; togas; boot and shoe uppers; turbans; wet suits for water-skiing; school and athletic uniforms; veils [clothing]; visors [headwear]; berets; hats; headgear, namely, caps, beanies; wooden shoes; clothing of imitations of leather, namely, tops, pants, jackets, gloves; clothing of leather, namely, tops, pants, jackets, gloves; motorists' clothing, namely, jackets, vests, pants; cyclists' clothing; clothing for gymnastics; sports wear; riding clothes, namely, coats, jackets, gloves, tops, pants; dresses; bath robes; belts (clothing); gilets; cabans; Bermuda shorts; mufflers.

**Claims**

Priority Filing Date: November 23, 2020, Country or Office: ITALY, Application No: 302020000103499 in association with the same kind of goods

**Application Number** 2,083,867  
**International Registration Number** 1574662  
**Language of Application** English

**Filing Date** 2020-11-03

## APPLICANT AND AGENT DETAILS

### Applicant

Beiersdorf AG  
Unnastr. 48  
20253 Hamburg  
GERMANY

### Agent

GOWLING WLG (CANADA) LLP  
SUITE 1600, 1 FIRST CANADIAN PLACE, 100  
KING STREET WEST, TORONTO, ONTARIO,  
M5X1G5

## TRADEMARK DETAILS

### Trademark Type

Design

### Visual Representation





### **Colour Claim**

Colour is claimed as a feature of the trademark. The colours green, white and black are claimed. The mark consists of two green concentric circles separated by a white gap, with the inner circle forming a globe with green continents and white oceans. Extending from the outer circle is a tree with a black trunk and green leaves.

### **Goods**

#### **Class 03**

(1) Non-medicated soaps, namely face and body soaps, beauty soaps; essential oils for personal use, nonmedicated skin care preparations for body and beauty care; non-medicated preparations for the care of the skin and face care products in form of creams, gels and lotions; deodorants and antiperspirants for personal use; non-medicated shaving and after-shave preparations; non-medicated preparations for the care, cleansing and embellishment of body and hair, namely skin care preparations, skin cleansing preparations, hair care preparations, hair shampoo and conditioner, hair dyes and colourants, hair gel, hair mousse, hair spray; bath and shower gels, lotions and salts, not for medical purposes; non-medicated sun protection and after-sun preparations.

#### **Class 05**

(2) Disinfectants soap and disinfectant hand wash; medicated skin preparations for body and beauty care for the care of extremely dry skin, sensitive skin, redness-prone skin, dermatitis, itchy skin, diabetic skin, acne prone skin, sweaty skin, aging skin, sun-exposed skin, eczema, psoriasis, rosacea and acne in form of creams, gels and lotions; dermatological preparations for the care of eczema, psoriasis, dermatitis, rosacea and acne; medicated preparations for cleansing the skin and medicated preparations for stimulating hair growth; medicated bath and shower gels and lotions for the treatment of irritated, itching and inflamed skin; medicated bath and shower salts; medicated sun protection preparations; medicated preparations for the prevention of ageing of the skin.

### **Claims**

Priority Filing Date: June 09, 2020, Country or Office: EUIPO (EU), Application No: 018251022 in association with the same kind of goods

**Application Number** 2,084,021  
**International Registration Number** 1574566  
**Language of Application** English

**Filing Date** 2020-12-11

## APPLICANT AND AGENT DETAILS

### Applicant

Takeda Pharmaceuticals International AG  
Thurgauerstrasse 130  
CH-8152 Glattpark-Opfikon  
SWITZERLAND

### Agent

GOWLING WLG (CANADA) LLP  
SUITE 2600, 160 ELGIN STREET, OTTAWA,  
ONTARIO, K1P1C3

## TRADEMARK DETAILS

# LIVTENCITY

### Trademark Type

Standard Characters

### Goods

#### Class 05

Pharmaceutical preparations for the treatment of post-transplant cytomegalovirus infections.

### Claims

Priority Filing Date: December 10, 2020, Country or Office: SWITZERLAND, Application No: 17693 /2020 in association with the same kind of goods



**Application Number** 2,084,049  
**International Registration Number** 1574634  
**Language of Application** English

**Filing Date** 2020-12-15

## APPLICANT AND AGENT DETAILS

### Applicant

Galderma Holding S.A.  
Zählerweg 10  
CH-6300 Zug  
SWITZERLAND

### Agent

COZEN O'CONNOR LLP  
Bay Adelaide Centre - West Tower, 333 Bay  
Street, Suite #1100, Toronto, ONTARIO,  
M5H2R2

## TRADEMARK DETAILS

# DAZLIA

### Trademark Type

Standard Characters

### Goods

#### Class 03

(1) Cosmetic preparations consisting of non-medicated gel and liquids for filling lines, wrinkles, scars, lips, for tightening the face and body and for rejuvenating the skin; Cosmetic skin care preparations; Cosmetics for the treatment of wrinkled skin; Skin care preparations for removing wrinkles

#### Class 05

(2) Medical preparations, sold individually and in a set, consisting of syringes pre-filled with a dermatological preparation for filling lines, wrinkles, scars, and lips; Medical preparations, sold individually and in a set, consisting of syringes pre-filled with a dermatological preparation for tightening the face and body and for rejuvenating the skin; Medicinal preparations for use in dermatology, namely dermatitis, skin pigmentation diseases and treatment of acne; medicinal preparations for the treatment of dermatological diseases and disorders namely fungal skin infections, viral skin infections and parasitic skin infections, psoriasis, and eczema; pharmaceutical preparations for use in dermatology, namely for filling lines, wrinkles, scars, and lips, for tightening the face and body, and for rejuvenating the skin, dermatitis, skin pigmentation diseases and treatment of acne; pharmaceutical preparations for the treatment of dermatological diseases and disorders namely fungal skin infections, viral skin infections and parasitic skin infections, psoriasis, and eczema; injectable dermal fillers; Muscle relaxants

#### Class 10

(3) Medical devices, sold individually and in a set, namely implants in gel form and syringes pre-filled with a dermatological preparation, each for filling lines, wrinkles, scars, and lips, tightening the face and body, and for rejuvenating the skin; Injection syringes; Injection devices for pharmaceutical products, namely syringes; Medical preparations, sold individually and in a set, consisting of syringes pre-filled with a dermatological preparation for filling lines, wrinkles, scars, and lips; Medical preparations, sold individually and in a set, consisting of syringes pre-filled with a dermatological preparation for tightening the face and body and for rejuvenating the skin

### Services

**Class 41**

(1) Education and instruction in the field of pharmaceuticals, cosmetics, and aesthetics; Training in the field of pharmaceuticals, cosmetics and aesthetics; Arranging and conducting conferences, seminars and workshops in the field of pharmaceuticals, cosmetics, and aesthetics; Instruction and provision of practical training in the field of medicines, cosmetics and aesthetics

**Class 44**

(2) Medical clinics; Providing medical information in the field of dermatology; Beauty salons; medical clinic services; Plastic surgery; Cosmetic treatment in the field of dermatology; injectable filling treatments for cosmetic use

**Claims**

Priority Filing Date: October 13, 2020, Country or Office: SWITZERLAND, Application No: 14456 /2020 in association with the same kind of goods and in association with the same kind of services

**Application Number** 2,084,053  
**International Registration Number** 1574959  
**Language of Application** English

**Filing Date** 2020-12-16

## APPLICANT AND AGENT DETAILS

### Applicant

LELIT S.R.L.  
VIALE DEL LAVORO 47,  
I-25045 CASTEGNATO  
BRESCIA  
ITALY

### Agent

ROBIC  
630, boul. René-Lévesque Ouest, 20e étage,  
Montréal, QUEBEC, H3B1S6

## TRADEMARK DETAILS

### Trademark Type

Design

### Visual Representation





**Goods**

**Class 08**

(1) Flat irons.

**Class 11**

(2) Electric coffee brewers

**Class 21**

(3) Ironing boards.

**Claims**

Priority Filing Date: December 11, 2020, Country or Office: ITALY, Application No: 302020000111545 in association with the same kind of goods

**Application Number** 2,084,437  
**Language of Application** English

**Filing Date** 2021-02-11

## APPLICANT AND AGENT DETAILS

### Applicant

Advatix, Inc. (a Delaware Corporation)  
2625 Townsgate Road, Suite 330  
Westlake Village, CA 91361  
UNITED STATES OF AMERICA

### Agent

NORTON ROSE FULBRIGHT CANADA LLP/S.  
E.N.C.R.L.,S.R.L.  
1800 - 510 West Georgia Street, Vancouver,  
BRITISH COLUMBIA, V6B0M3

## TRADEMARK DETAILS

# XPDEL

### Trademark Type

Standard Characters

### Services

#### Class 39

Supply chain logistics and reverse logistics services consisting of the delivery, storage and transportation of goods for others by air, rail, ship or truck; Commercial order fulfillment services for third parties, namely, packing, crating, warehousing services and packaging of articles for transportation by air, rail, ship or truck.

**Application Number** 2,085,469  
**International Registration Number** 1575887  
**Language of Application** English

**Filing Date** 2020-12-11

## APPLICANT AND AGENT DETAILS

### Applicant

Maria Nilova  
19 Lever Street, Suite 315  
MANCHESTER, Lancashire M1 1AN  
UNITED KINGDOM

### Agent

MBM INTELLECTUAL PROPERTY AGENCY  
275 SLATER STREET, 14TH FLOOR,  
OTTAWA, ONTARIO, K1P5H9

## TRADEMARK DETAILS

# PATENTICA

### Trademark Type

Standard Characters

### Services

#### Class 41

(1) Arranging and conducting correspondence courses in the field of intellectual property; Providing entertainment information, namely, information about trivia competitions provided via a website in the field of intellectual property; club services, namely, country club services, social club-type entertainment services in the legal field; organization of competitions, namely, competitions in the field of intellectual games; providing information about intellectual games; publication of legal texts; translation services, including patent translation services; arranging and conducting of congresses, conferences, seminars, symposiums in the field of intellectual property law; organization of exhibitions for educational purposes in the field of intellectual property protection; educational services in the field of intellectual property protection

#### Class 45

(2) Copyright management; trademark searches; intellectual property services namely, patenting inventions, designs and registration of trademarks; intellectual property maintenance services; legal consultation services; legal research; patent searches; licensing of intellectual property; domain name registration services; patent attorney services; patent research; domain name maintenance services; litigation services; intellectual property consultancy; intellectual property watching services; legal consultancy services

Application Number 2,085,729  
Language of Application English

Filing Date 2021-02-18

## APPLICANT DETAILS

Applicant  
Miriam Paille  
378 Russell St  
1195  
Haileybury  
ONTARIO  
P0J1K0

## TRADEMARK DETAILS

Trademark Type  
Design

Visual Representation



**Colour Claim**

Colour is claimed as a feature of the trademark. Barking Bites and Grooming lettering appears in Persian blue. The dog is black, brown, and white, with gun metal, blue shading, and also brown, white, and black. the dog's eyes are formed as hearts, and a black and pink nose with white teeth. The dog is holding a white bone in his mouth with gun metal blue shading. Behind the dog is a stylized heart in sky blue outlined in black.

**Goods****Class 31**

biscuits for animals

**Services****Class 44**

animal grooming



**Application Number** 2,085,881  
**Language of Application** English

**Filing Date** 2021-02-18

## APPLICANT AND AGENT DETAILS

### Applicant

Northwest Confections Canada Inc.  
400 - 725 Granville Street  
10325  
Vancouver  
BRITISH COLUMBIA  
V7Y1G5

### Agent

MILLER THOMSON LLP  
SCOTIA PLAZA, 40 KING STREET WEST,  
SUITE 5800, P.O. BOX 1011, TORONTO,  
ONTARIO, M5H3S1

## TRADEMARK DETAILS

# WYLD REAL FRUIT GUMMIES

### Trademark Type

Standard Characters

### Goods

#### Class 30

(1) brownies containing marijuana; candy; candy mints; caramels; chocolate and chocolates; chocolate bars infused with cannabis; cookies; fruit jelly candy; milk chocolate; mints for breath freshening

(2) White. milk and dark chocolates; Gummy candies; Hard candies; Jelly candies; Candy infused with cannabis; Fruit jelly candy infused with cannabis; Chocolate and chocolates infused with cannabis;

### Services

#### Class 35

Retail store services for milk chocolate, white. milk and dark chocolates, gummy candies, hard candies, jelly candies, candy mints, caramels, cookies, chocolate bars infused with cannabis, candy, candy infused with cannabis, fruit jelly candy, fruit jelly candy infused with cannabis, mints for breath freshening, chocolate and chocolates, chocolate and chocolates infused with cannabis, brownies containing marijuana; Retail sales of milk chocolate, white. milk and dark chocolates, gummy candies, hard candies, jelly candies, candy mints, caramels, cookies, chocolate bars infused with cannabis, candy, candy infused with cannabis, fruit jelly candy, fruit jelly candy infused with cannabis, mints for breath freshening, chocolate and chocolates, chocolate and chocolates infused with cannabis, brownies containing marijuana; Online sales of milk chocolate, white. milk and dark chocolates, gummy candies, hard candies, jelly candies, candy mints, caramels, cookies, chocolate bars infused with cannabis, candy, candy infused with cannabis, fruit jelly candy, fruit jelly candy infused with cannabis, mints for breath freshening, chocolate and chocolates, chocolate and chocolates infused with cannabis, brownies containing marijuana; Mail order sales of milk chocolate, white. milk and dark chocolates, gummy candies, hard candies, jelly candies, candy mints, caramels, cookies, chocolate bars infused with cannabis, candy, candy infused with cannabis, fruit jelly candy, fruit jelly candy infused with cannabis, mints for breath freshening, chocolate and chocolates, chocolate and chocolates infused with cannabis, brownies containing

marijuana; Wholesale sales of milk chocolate, white. milk and dark chocolates, gummy candies, hard candies, jelly candies, candy mints, caramels, cookies, chocolate bars infused with cannabis, candy, candy infused with cannabis, fruit jelly candy, fruit jelly candy infused with cannabis, mints for breath freshening, chocolate and chocolates, chocolate and chocolates infused with cannabis, brownies containing marijuana;

**Application Number** 2,085,901  
**Language of Application** English

**Filing Date** 2021-02-18

## APPLICANT AND AGENT DETAILS

### Applicant

Northwest Confections Canada Inc.  
400 - 725 Granville Street  
10325  
Vancouver  
BRITISH COLUMBIA  
V7Y1G5

### Agent

MILLER THOMSON LLP  
SCOTIA PLAZA, 40 KING STREET WEST,  
SUITE 5800, P.O. BOX 1011, TORONTO,  
ONTARIO, M5H3S1

## TRADEMARK DETAILS

### Trademark Type

Design

### Visual Representation



# REAL FRUIT GUMMIES

### Goods

#### Class 30

(1) brownies containing marijuana; candy; candy mints; caramels; chocolate and chocolates; chocolate bars infused with cannabis; cookies; fruit jelly candy; milk chocolate; mints for breath freshening

(2) White. milk and dark chocolates; Gummy candies; Hard candies; Jelly candies; Candy infused with cannabis; Fruit jelly candy infused with cannabis; Chocolate and chocolates infused with cannabis;

### Services

#### Class 35

Retail store services for milk chocolate, white. milk and dark chocolates, gummy candies, hard candies, jelly candies, candy mints, caramels, cookies, chocolate bars infused with cannabis, candy, candy infused with cannabis, fruit jelly candy, fruit jelly candy infused with cannabis, mints

for breath freshening, chocolate and chocolates, chocolate and chocolates infused with cannabis, brownies containing marijuana; Retail sales of milk chocolate, white. milk and dark chocolates, gummy candies, hard candies, jelly candies, candy mints, caramels, cookies, chocolate bars infused with cannabis, candy, candy infused with cannabis, fruit jelly candy, fruit jelly candy infused with cannabis, mints for breath freshening, chocolate and chocolates, chocolate and chocolates infused with cannabis, brownies containing marijuana; Online sales of milk chocolate, white. milk and dark chocolates, gummy candies, hard candies, jelly candies, candy mints, caramels, cookies, chocolate bars infused with cannabis, candy, candy infused with cannabis, fruit jelly candy, fruit jelly candy infused with cannabis, mints for breath freshening, chocolate and chocolates, chocolate and chocolates infused with cannabis, brownies containing marijuana; Mail order sales of milk chocolate, white. milk and dark chocolates, gummy candies, hard candies, jelly candies, candy mints, caramels, cookies, chocolate bars infused with cannabis, candy, candy infused with cannabis, fruit jelly candy, fruit jelly candy infused with cannabis, mints for breath freshening, chocolate and chocolates, chocolate and chocolates infused with cannabis, brownies containing marijuana; Wholesale sales of milk chocolate, white. milk and dark chocolates, gummy candies, hard candies, jelly candies, candy mints, caramels, cookies, chocolate bars infused with cannabis, candy, candy infused with cannabis, fruit jelly candy, fruit jelly candy infused with cannabis, mints for breath freshening, chocolate and chocolates, chocolate and chocolates infused with cannabis, brownies containing marijuana;

**Application Number** 2,087,061  
**International Registration Number** 1577451  
**Language of Application** English

**Filing Date** 2020-10-14

## APPLICANT AND AGENT DETAILS

### Applicant

Fundbox Ltd.  
23 Yehuda Halevi St.  
6513601 Tel Aviv  
ISRAEL

### Agent

GOWLING WLG (CANADA) LLP  
SUITE 1600, 1 FIRST CANADIAN PLACE, 100  
KING STREET WEST, TORONTO, ONTARIO,  
M5X1G5

## TRADEMARK DETAILS

### Trademark Type

Design

### Visual Representation



### Trademark Description

The mark consists of blue paint brush stroke.

### Colour Claim

Colour is claimed as a feature of the trademark. The applicant claims the colour blue as a feature of the trademark. The paintbrush stroke is blue.

### Services

#### Class 35

(1) Providing business information about commercial financial transaction data, financial account management, financial data management, operations management, financial reporting, accounting features, credit, invoice advances, loan assistance and related credit reference information for small and medium sized businesses, via a website; providing online business management services that provide assistance to small and medium sized businesses; business management services, namely, managing office functions in the nature of financial transactions, invoice advances and credit for small and medium sized businesses; providing commercial financial transaction data, financial account management, financial reporting, invoicing services, factoring services, credit services, accounting features and related credit reference information for small to medium sized businesses, via a website; business advice and information relating to loans, finance and capital investment

#### Class 36

(2) Providing cash advances for businesses and merchants, financing of loans, credit, invoice advances and loan assistance for small to medium sized businesses, via a website; providing data operations, namely, electronic financial data processing, analytics, underwriting and financial risk management services for electronic and ACH funds transfer, credit and debit card and electronic check transactions and underwriting via a global computer network for small and medium sized businesses; financial affairs and monetary affairs, namely, financial asset management and financial planning information, management and analysis services for small and medium sized businesses; electronic loan and credit preparation and assistance for small and medium sized businesses

#### **Class 42**

(3) Platform as a service (PAAS) featuring computer software platforms for commercial financial transaction data, financial account management, financial data operations, financial reporting, accounting features, credit financing, invoice advances, loan assistance and related credit reference information for small and medium sized businesses

#### **Claims**

Priority Filing Date: April 17, 2020, Country or Office: UNITED STATES OF AMERICA, Application No: 88875686 in association with the same kind of services (1); April 17, 2020, Country or Office: UNITED STATES OF AMERICA, Application No: 88875690 in association with the same kind of services (3); April 17, 2020, Country or Office: UNITED STATES OF AMERICA, Application No: 88875687 in association with the same kind of services (2)

**Application Number** 2,087,222  
**International Registration Number** 1577491  
**Language of Application** English

**Filing Date** 2020-12-22

## APPLICANT AND AGENT DETAILS

### Applicant

Braun GmbH  
Frankfurter Str. 145  
61476 Kronberg im Taunus  
GERMANY

### Agent

TORYS LLP  
SUITE 3000, 79 WELLINGTON ST. W., BOX  
270, TD CENTRE, TORONTO, ONTARIO,  
M5K1N2

## TRADEMARK DETAILS

# BRAUN CLEAR

### Trademark Type

Standard Characters

### Goods

#### Class 10

Hearing aids; electrical hearing aids; assistive listening devices for the hearing impaired, namely medical hearing instruments; hearing enhancement products, namely, electric hearing aids, electrical hearing aids, electronic hearing aids and electrically operated hearing aids; handheld electronic units for adjusting sound levels in hearing aids; hearing aid listeners; accessories and components for hearing aids; hearing protectors; wireless transmitters and receivers for use with hearing aids; personal sound amplification products, namely digital hearing aids, programmable hearing prostheses; hearing muffs for the amplification of sounds for the digital hearing aids, programmable hearing aids; part and fittings for hearing aids, namely, remote controls, batteries, and wireless data streaming devices; and custom ear plugs for noise reduction and soundproofing, and earbuds with sound isolating inserts.

**Application Number** 2,087,292  
**International Registration Number** 1577831  
**Language of Application** English

**Filing Date** 2021-01-06

## APPLICANT AND AGENT DETAILS

### Applicant

Pioneer Surgical Technology, INC.  
520 Lake Cook Road, Suite 315  
Deerfield, ILLINOIS, 60015  
UNITED STATES OF AMERICA

### Agent

RIDOUT & MAYBEE LLP  
250 University Avenue, 5th Floor, Toronto,  
ONTARIO, M5H3E5

## TRADEMARK DETAILS

# MORE THAN POSSIBLE

### Trademark Type

Standard Characters

### Goods

#### Class 05

(1) Bone fillers consisting of biological materials; bone fillers consisting of natural materials; bone cement for medical purposes; bone paste for medical purposes; implantable orthopedic devices, namely, surgical implants and bone implants composed of living or natural materials; spinal fixation implants and stabilization materials composed of living or natural materials

#### Class 10

(2) Medical and surgical implants composed of artificial materials; orthopedic implants composed of artificial materials; bone substitutes for surgical use; biocompatible coating for implantable medical devices; syringes for medical purposes and for injections; injection devices for bone cement, bone graft or bone filler; medical instruments for use in bone grafting, namely, orthopedic surgical instruments; spinal implants composed of artificial material; spinal fixation implants and stabilization devices composed of artificial material; surgical instruments; surgical instruments for use in orthopedic and spinal surgery; cases fitted for surgical instruments for medical purposes

### Services

#### Class 44

Providing medical information to medical professionals in the fields of orthopedic and spinal surgery

### Claims

Priority Filing Date: July 14, 2020, Country or Office: UNITED STATES OF AMERICA, Application No: 90052608 in association with the same kind of goods and in association with the same kind of services



**Application Number** 2,087,316  
**International Registration Number** 1577401  
**Language of Application** English

**Filing Date** 2021-01-08

## APPLICANT AND AGENT DETAILS

### Applicant

Oliver Scheiter  
An der Vogelrute 38  
59387 Ascheberg  
GERMANY

### Agent

GOWLING WLG (CANADA) LLP  
1 PLACE VILLE MARIE, 37TH FLOOR/37E  
ETAGE, MONTREAL, QUEBEC, H3B3P4

## TRADEMARK DETAILS

# PLASMASAFE

### Trademark Type

Standard Characters

### Foreign Character Translation

PLASMASAFE.

### Goods

#### Class 10

Medical apparatus and instruments, namely, centrifuges for separating blood components for medical purposes, and treatment kits, namely, blood extraction and collection tubes, tube stands, syringes, hypodermic needles, and compress cloths, all for medical purposes.

### Claims

Priority Filing Date: July 22, 2020, Country or Office: EUIPO (EU), Application No: 018276160 in association with the same kind of goods

**Application Number** 2,087,322  
**International Registration Number** 1577225  
**Language of Application** English

**Filing Date** 2021-01-11

## APPLICANT AND AGENT DETAILS

### Applicant

Integral Ad Science, Inc.  
8th Floor  
95 Morton Street  
New York NY 10014  
UNITED STATES OF AMERICA

### Agent

ZAK MUSCOVITCH  
(Muscovitch Law Professional Corp.), 534  
Lawrence Avenue West, Unit 201, Toronto,  
ONTARIO, M6A1A2

## TRADEMARK DETAILS

# IAS

### Trademark Type

Standard Characters

### Services

#### Class 35

Commercial information services related to advertising, via the internet; market reports and studies; analysis of advertising response; planning, development, maintenance, tracking and reporting of online marketing activities for third parties; provision of marketing reports, all of the aforesaid services excluding the agricultural field.

### Claims

Priority Filing Date: July 10, 2020, Country or Office: UNITED STATES OF AMERICA, Application No: 90047105 in association with the same kind of services

**Application Number** 2,087,416  
**International Registration Number** 1577692  
**Language of Application** English

**Filing Date** 2021-01-21

## APPLICANT AND AGENT DETAILS

### Applicant

Beihua Yu  
36-38 Gipps Street  
Collingwood VIC 3066  
AUSTRALIA

### Agent

BORDEN LADNER GERVAIS LLP  
Bay Adelaide Centre, East Tower, 22 Adelaide  
St. West, TORONTO, ONTARIO, M5H4E3

## TRADEMARK DETAILS

# ettitude

### Trademark Type

Standard Characters

### Goods

#### Class 03

(1) Biological laundry detergents; chemical laundry products, namely chemical cleaners in liquid form and in spray form for industrial and household use; detergents for laundry use; fabric softeners (for laundry use); laundry detergent; laundry preparations in liquid form, in spray form, and in powder form, laundry preparations namely laundry bleach, laundry pre-soak, laundry additives for water softening, laundry brightener, laundry soap, laundry stain removers, and laundry starch.

#### Class 24

(2) Bath sheets (towels); bath towels; beach towels; face towels of textile; golf towels; hand towels of textile; hooded towels; kitchen towels (textile); tea towels; terry towels; towels of textile; towels (textile) for kitchen use; towels (textile) for use in connection with babies; towels (textile) for use in connection with toddlers; bath linen (except clothing); bathroom linen; bed linen; bedding (linen); coasters (table linen); household linen; infants' bed linen; kitchen linen; linen cloth; table linen (not of paper); bed sheets; bed quilts; quilt covers; quilted blankets (bedding); quilts; bed blankets; blanket throws; cot blankets; pillow cases; mattress covers; mattress protectors (other than incontinence); duvet covers; duvets; comforters; comforters for beds.

#### Class 25

(3) Clothing, namely, t-shirts, sweatshirts, cardigans, pants, leggings, tights, skirts, shorts, coats, jackets, and gloves, footwear, namely shoes, boots, sandals, and slippers, headgear, namely, hats and caps; aprons (clothing); athletic clothing; babies' pants (clothing); beach clothing; belts (clothing); boys' clothing; cashmere clothing, namely cashmere sweaters, shawls, scarves, jackets, and gloves; casual clothing; children's clothing; business clothing, dress clothing, formal clothing, intimate apparel, loungewear, outdoor winter clothing, sleepwear, sun protective clothing, and undergarments; clothing for babies; clothing for sports; clothing for surfing; clothing for swimming; cyclists' clothing; denim clothing, namely pants, shorts, shirts, dresses, coats, and jackets; girl's clothing; gloves (clothing); golf clothing (other than gloves); headbands (clothing); clothing hoods, namely fleece hoods and ski hoods; infants' clothing; jackets (clothing); jerseys (clothing);

knitwear, namely, knit bottoms, knit tops, knit dresses, knit jackets, knit caps, knit hats, and knit gloves; maternity clothing; motorcyclists' clothing (other than for protection against accident or injury); silk sleep masks; sports clothing (other than golf gloves); tennis clothing; thermal clothing; thong underwear; three piece suits (clothing); water-resistant clothing, namely water-resistant jackets, pants, shoes, and boots; clothing wraps, namely shoulder wraps, head wraps, bath wraps, and beach wraps; bed socks; footless socks; slipper socks; socks; sports socks; anti-sweat underwear; disposable underwear; shapewear (slimming underwear); slimming underwear; sweat-absorbent underclothing (underwear); underwear; bath robes.

**Application Number** 2,087,809  
**Language of Application** English

**Filing Date** 2021-02-26

## **APPLICANT DETAILS**

**Applicant**

Shelly Fekete  
496 Jerseyville Rd W  
Ancaster  
ONTARIO  
L9G3L5

## **TRADEMARK DETAILS**

# **The Farmhouse Yoga Studio Canada**

**Trademark Type**

Standard Characters

**Services**

**Class 41**

yoga instruction

**Application Number** 2,088,118  
**Language of Application** English

**Filing Date** 2021-03-01

## APPLICANT AND AGENT DETAILS

### Applicant

Sony Interactive Entertainment Inc.  
1-7-1 Konan  
Minato-ku  
Tokyo,  
JAPAN

### Agent

CASSAN MACLEAN IP AGENCY INC.  
190 O'CONNOR STREET, SUITE 710,  
OTTAWA, ONTARIO, K2P2R3

## TRADEMARK DETAILS

# PS4

### Trademark Type

Standard Characters

### Goods

#### Class 09

(1) Downloadable game software; recorded game software; downloadable computer game software; downloadable virtual reality game software; recorded virtual reality game software; downloadable computer application software for mobile phones and handheld computers, namely, software for communicating with other users, viewing digital images and photographs in the field of gaming, and managing and controlling video game consoles; downloadable computer application software for mobile phones and handheld computers, namely, software for searching, viewing, streaming, and downloading videos, movies, and television shows; virtual reality headsets; electronic docking stations for laptops, mobile phones, and MP3 players; battery chargers used for controllers for game consoles; external computer hard drives [computer storage devices]; magnetically encoded gift cards; computer operating software; electric batteries for laptops, cellphones, video game machines and video game controllers; battery chargers for video game machines; electrical conductors for transformers; telecommunication machines and apparatus, namely, modems, network routers, and mobile phones; personal computers; computers and computer peripheral devices, namely, printers, scanners, keyboards, mouse, webcams, microphones, headphones and computer speakers; headsets for use in playing video games.

#### Class 28

(2) Video game consoles; controllers for game consoles; game controllers for computer games; video game interactive hand held remote controls for playing electronic games; controllers for game consoles in the nature of motion controllers; headsets for use in playing video games; video game interactive remote control units; cameras for video game consoles; toys, namely, electronic action toys and electronic learning toys.

### Services

#### Class 36

Trading of cryptocurrency for use by members of an on-line community via a global computer network; exchange services of cryptocurrency for use by members of an on-line community via a global computer network.

**Application Number** 2,088,902  
**International Registration Number** 1578188  
**Language of Application** English

**Filing Date** 2020-11-18

## APPLICANT AND AGENT DETAILS

### Applicant

XinWangYuan Technology (Shenzhen) Co.,  
LTD.  
Room 1402, Shanghai Automobile Building,  
4050 Nanhai Avenue, Yuehai Street,  
Nanshan District, Shenzhen  
Guangdong Province  
CHINA

### Agent

ANITA MAR  
dba Trademark Angel, Suite 521, 6-2557  
Dougall Avenue, Windsor, ONTARIO, N8X1T5

## TRADEMARK DETAILS

# PokerGaga

### Trademark Type

Standard Characters

### Goods

#### Class 09

Computer game software downloadable from a global computer network; computer game software downloadable via a global computer network and wireless devices; computer game programs downloadable via the Internet; recorded computer game programs; recorded computer game software; computer game software for use on mobile and cellular phones; downloadable computer game programs; computer software for interacting with blockchain platforms; computer software platforms for social networking; downloadable computer software platform for assisting programming developers to collaborate on digital computer programming code as used in multiple application programs; interactive touch screen terminals; facial recognition software

### Services

#### Class 41

Organization of electronic game competitions; online publication of electronic books and journals; online publication of electronic books and magazines; entertainment services, namely, providing online computer game; entertainment in the nature of videogame tournaments; providing information on entertainment in the field of computer games and video games; providing on-line computer games; virtual reality game services provided on-line from a computer network; electronic games services provided by means of the Internet; online game services provided via a computer network; providing online video games [entertainment services]; providing non-downloadable digital music from the Internet

### Claims

Priority Filing Date: September 21, 2020, Country or Office: CHINA, Application No: 49908596 in association with the same kind of services; September 21, 2020, Country or Office: CHINA, Application No: 49900742 in association with the same kind of goods

**Application Number** 2,089,045  
**International Registration Number** 1579425  
**Language of Application** English

**Filing Date** 2020-12-28

## APPLICANT AND AGENT DETAILS

### Applicant

Hengfu Smart Home Co., Ltd.  
North of Xitang Village,  
Zhoucun District  
250101 Shandong Province  
CHINA

### Agent

WITMART INC.  
34 King Street East, Suite 500, Toronto,  
ONTARIO, M5C2X8

## TRADEMARK DETAILS

### Trademark Type

Design

### Visual Representation

be11able

### Goods

#### Class 20

Mattresses; beds; pillows; bedroom furniture; tables; divans; sofas; cabinet work; bedsteads of metal; spring mattresses.



**Application Number** 2,089,072  
**International Registration Number** 1579006  
**Language of Application** English

**Filing Date** 2020-12-30

## APPLICANT AND AGENT DETAILS

### Applicant

SFERRA FINE LINENS, LLC  
300 Crescent Court; Suite 550  
Dallas, TX 75201  
UNITED STATES OF AMERICA

### Agent

MACRAE & CO.  
326 Somerset Street West, Ottawa, ONTARIO,  
K2P0J9

## TRADEMARK DETAILS

# SFERRA

### Trademark Type

Standard Characters

### Goods

#### Class 24

Table linen; table linen, namely, tablecloths not of paper, coasters, table mats not of paper, napkins, placemats, table runners; bed linen, bed sheets, bedspreads, pillow cases, pillow covers, pillow shams, duvet covers, blankets, throws, lap robes; baby blankets, baby bed linens, baby quilts, shams; bath towels, hand towels, washcloths and bath sheets.

**Application Number** 2,089,455  
**Language of Application** English

**Filing Date** 2021-03-04

## APPLICANT AND AGENT DETAILS

### Applicant

Shanghai Hode Information Technology Co.,  
Ltd  
Room 905 and 906  
No. 1, Lane 2277 Zuchongzhi Road  
Pilot Free Trade Zone  
Shanghai, 201203  
CHINA

### Agent

OSLER, HOSKIN & HARCOURT LLP  
Suite 320, World Exchange Plaza, 100 Queen  
Street, Ottawa, ONTARIO, K1P1J9

## TRADEMARK DETAILS

# BILIBILI

### Trademark Type

Standard Characters

### Services

#### Class 38

(1) Online digital video, audio and multimedia entertainment namely, live broadcasting services.

#### Class 41

(2) Entertainment services, namely, providing non-downloadable anime, videos, movies, television series, user-generated content in the form of blogs, audio content, and multimedia entertainment content namely, video games, via the Internet and global communications networks in the fields of videos, films, anime, music, dance, television programs, and new broadcasts; providing entertainment services via the Internet and global communications networks in the nature of websites featuring entertainment information, comments, reviews, recommendations in the fields of anime, videos, movies, television series, computer games, and new broadcasts, and video games; entertainment services, namely, providing esports tournaments and video game services in the field of esports and video games via the Internet and global communications networks; entertainment services, namely, providing online non downloadable anime, videos, movies, television series, and other multimedia digital content namely, video games, and cartoons via the internet and global communications networks.

**Application Number** 2,091,095  
**International Registration Number** 1579560  
**Language of Application** English

**Filing Date** 2021-01-26

## APPLICANT AND AGENT DETAILS

### Applicant

SICHUAN YIBIN WULIANGYE GROUP CO.,  
LTD  
#150, MinJiang West Road,  
Yibin  
Sichuan  
CHINA

### Agent

NEOMARK LTD.  
7450 rue Saint-Hubert, Montréal, QUEBEC,  
H2R2N3

## TRADEMARK DETAILS

### Trademark Type

Design

### Visual Representation

五 粮 液  
WULIANGYE

### Trademark Description

The mark consists of three stylized Chinese characters WU LIANG YE and letters WULIANGYE below.

### Foreign Character Translation

The translation provided by the applicant of the Chinese word(s) WU LIANG YE is "five", "grain" and "liquid".

### Foreign Character Transliteration

The transliteration provided by the applicant of the Chinese character(s) is WU LIANG YE.

### Goods

Class 30

Coffee; tea; tea-based beverages; sugar; honey; cereal-based snack food; bread; moon cakes; pastries; sandwiches; baozi; jiaozi; pizzas; ready-to-eat cereals; noodles; pasta; ice cream; starch for food; vanilla flavorings.

**Application Number** 2,091,535  
**Language of Application** French

**Filing Date** 2021-03-12

## **APPLICANT DETAILS**

### **Applicant**

Julien Le Bohec  
2186 rue Nicolet  
Montréal  
QUÉBEC  
H1W3L2

## **TRADEMARK DETAILS**

# **Breizh Traveller**

### **Trademark Type**

Standard Characters

### **Foreign Character Translation**

The French translation provided by the applicant of the words "breizh traveller" is "voyageur breton".

### **Goods**

#### **Class 25**

tams; slipovers; sweaters; hooded pullovers; sweatshirts; tee-shirts

**Application Number** 2,091,772  
**Language of Application** English

**Filing Date** 2021-03-13

## APPLICANT DETAILS

### Applicant

OSPAR Consulting Ltd  
119 CHATAWAY BLVD  
WINNIPEG  
MANITOBA  
R3P0A2

## TRADEMARK DETAILS

# Reaching For Zero

### Trademark Type

Standard Characters

### Goods

#### Class 04

biofuel; coal based fuels; crude oils; fuel from crude oil; gas oil; gas oil for domestic heating; liquefied natural gas; liquefied petroleum gases; motor fuel; natural gas; petroleum; propane for use as fuel

### Services

#### Class 40

(1) electricity generation; electrolysis of water; generating electricity; generation of electricity; generation of electricity from solar energy; generation of gas and electricity; heat treatment of metals; liquefaction of natural gas; liquefaction of petroleum gas

#### Class 41

(2) educational demonstrations in the field of home energy conservation

#### Class 42

(3) biochemical research and analysis; chemical research; development and test of chemical production methods; greenhouse gas emission measuring and analysis; information on the subject of scientific research in the field of biochemistry and biotechnology; laboratory research in the field of chemistry; planning of buildings and infrastructure systems for buildings; providing scientific information in the fields of climate change and global warming; providing technological information for environmentally-conscious and green inventions in the field of biofuels; providing technological information for environmentally-conscious and green inventions in the field of solar powered vehicles; providing technological information for environmentally-conscious and green inventions in the field of wind farms; providing technology information in the oil and gas industry; research in the field of biochemistry; research in the field of chemistry; research in the field of environmental protection; technical consultancy in the field of environmental science; technological consulting services in the field of alternative energy generation; testing of filters

**Application Number** 2,091,777  
**Language of Application** English

**Filing Date** 2021-03-13

## APPLICANT DETAILS

### Applicant

Chuan Liu  
5337 Jameson Crescent  
Burlington  
ONTARIO  
L7L6Z1

## TRADEMARK DETAILS

# Rusty Design

### Trademark Type

Standard Characters

### Goods

#### Class 01

(1) unprocessed epoxy resins; unprocessed synthetic resins for use in the manufacture of plastic molding compounds

#### Class 02

(2) oils for the preservation of wood; preservative oils for wood

#### Class 06

(3) couplings and joints of metal for pipes; elbows of metal for pipes; fittings of metal for pipes; ground tubes of steel; rolled and peeled ground tubes of steel; wrought iron decorative artwork

**Application Number** 2,091,805  
**Language of Application** English

**Filing Date** 2021-03-15

## **APPLICANT DETAILS**

### **Applicant**

Bellevue Marketing  
200-4388 Rue Saint-Denis  
#413  
Montréal  
QUEBEC  
H2J2L1

## **TRADEMARK DETAILS**

**Trademark Type**

Design

**Visual Representation**





# bellevu

**Disclaimer**

The right to the exclusive use of the word Bellevue is disclaimed apart from the trademark.

**Goods****Class 28**

portable support structures for dance and other exercises; stress relief exercise toys

**Application Number** 2,091,830  
**Language of Application** English

**Filing Date** 2021-03-15

## APPLICANT DETAILS

### Applicant

Dave St. Jean  
242 Southside Dr  
Nanaimo  
BRITISH COLUMBIA  
V9R6Z5

## TRADEMARK DETAILS

# St. Jean's

### Trademark Type

Standard Characters

### Goods

#### Class 29

canned fish; canned seafood; canned tuna; clam juice; clams; dried fish; fish; fish and meat preserves; fish fillets; fish sausages; fish spreads; frozen fish; jellies and jams; mussels; oysters; salmon; salted fish; seafood; short-necked clams; shrimps, prawns, and lobsters; smoked fish; smoked salmon; tinned fish; tinned seafood; tuna fish

**Application Number** 2,092,345  
**Language of Application** English

**Filing Date** 2021-03-17

## APPLICANT DETAILS

### Applicant

North Earth Activewear Inc.  
2220 Midland Avenue  
Unit# 66AP  
Scarborough  
ONTARIO  
M1P3E6

## TRADEMARK DETAILS

### Trademark Type

Design

### Visual Representation



### Goods

### Class 25

women's sportswear; yoga pants

**Application Number** 2,092,346  
**Language of Application** English

**Filing Date** 2021-03-17

## APPLICANT DETAILS

### Applicant

North Earth Activewear Inc.  
2220 Midland Avenue  
Unit # 66AP  
Scarborough  
ONTARIO  
M1P3E6

## TRADEMARK DETAILS

### Trademark Type

Design

### Visual Representation



### Goods

#### Class 25

athletic wear; women's sportswear; woven shirts; woven tops; yoga pants

**Application Number** 2,092,800  
**International Registration Number** 1581607  
**Language of Application** English

**Filing Date** 2021-01-26

## APPLICANT AND AGENT DETAILS

### Applicant

SICHUAN YIBIN WULIANGYE GROUP CO.,  
LTD  
#150, Minjiang West Road, Yibin  
Sichuan  
CHINA

### Agent

NEOMARK LTD.  
7450 rue Saint-Hubert, Montréal, QUEBEC,  
H2R2N3

## TRADEMARK DETAILS

### Trademark Type

Design

### Visual Representation

**WULIANG TEQU**

**五粮特曲**

### Trademark Description

The mark consists of letters "WU LIANG TE QU" above four Chinese characters.

### Foreign Character Translation

The translation provided by the applicant of the Chinese word(s) WU LIANG TE QU is "five", "grain", "special", "song" and "twist".

### Foreign Character Transliteration

The transliteration provided by the applicant of the Chinese character(s) is WU LIANG TE QU.

### Goods

Class 33

Baijiu [Chinese distilled alcoholic beverage]; fruit extracts, alcoholic; baiganr [Chinese rice-based white liquor]; Chinese spirit of sorghum [gaolian-jiou]; laojiou [Chinese sorghum-based brewed liquor]; alcoholic beverages containing fruit; alcoholic cocktails; wine; arrack; whisky; sparkling wine; distilled spirits of rice [awamori]

**Application Number** 2,092,802  
**International Registration Number** 1581604  
**Language of Application** English

**Filing Date** 2021-01-26

## APPLICANT AND AGENT DETAILS

**Applicant**  
SICHUAN YIBIN WULIANGYE GROUP CO.,  
LTD  
#150, Minjiang West Road, Yibin  
Sichuan  
CHINA

**Agent**  
NEOMARK LTD.  
7450 rue Saint-Hubert, Montréal, QUEBEC,  
H2R2N3

## TRADEMARK DETAILS

**Trademark Type**  
Design

### Visual Representation

五 粮 液  
WULIANGYE

### Trademark Description

The mark consists of three Chinese characters above the letters "WU LIANG YE".

### Foreign Character Translation

The translation provided by the applicant of the Chinese word(s) WU LIANG YE is "five", "grain" and "liquid".

### Foreign Character Transliteration

The transliteration provided by the applicant of the Chinese character(s) is WU LIANG YE.

### Goods

Class 32

Beer; beer-based cocktails; drinking waters; fruit juices; soda water; non-alcoholic fruit juice beverages; non-alcoholic beer-flavored beverages; non-alcoholic cocktails; mineral water [beverages]; syrups for making non-alcoholic beverages.



**Application Number** 2,092,804  
**International Registration Number** 1581578  
**Language of Application** English

**Filing Date** 2021-01-26

## APPLICANT AND AGENT DETAILS

**Applicant**  
SICHUAN YIBIN WULIANGYE GROUP CO.,  
LTD  
#150, Minjiang West Road, Yibin  
Sichuan  
CHINA

**Agent**  
NEOMARK LTD.  
7450 rue Saint-Hubert, Montréal, QUEBEC,  
H2R2N3

## TRADEMARK DETAILS

**Trademark Type**  
Design

**Visual Representation**



**Trademark Description**

The mark consists of an outer circle with an inner circle enclosing a letter "W" and five rays emanating from the center of the outer circle toward the bottom half of the outer circle.

**Goods****Class 30**

Coffee; tea; tea-based beverages; sugar; chocolate; bee glue; cookies; cereal-based snack food; instant rice; ready-to-eat cereals; noodles; popcorn; starch for food; ice cream; vinegar; cooking salt; chili oil for use as a seasoning or condiment; yeast; food seasonings.

**Application Number** 2,092,805  
**International Registration Number** 1581542  
**Language of Application** English

**Filing Date** 2021-01-26

## APPLICANT AND AGENT DETAILS

### Applicant

Sichuan Yibin Wuliangye Group Co., Ltd  
#150, Minjiang West Road,  
Yibin  
Sichuan  
CHINA

### Agent

NEOMARK LTD.  
7450 rue Saint-Hubert, Montréal, QUEBEC,  
H2R2N3

## TRADEMARK DETAILS

### Trademark Type

Design

### Visual Representation



**Trademark Description**

The mark consists of an outer circle with an inner circle enclosing a letter "W" and five rays emanating from the top center of the outer circle toward the bottom half of the outer circle.

**Services****Class 35**

Online advertising for others via a computer communications network; publicity agents; product demonstrations of baijiu [Chinese sorghum-based distilled alcoholic beverage]; providing information about business management; commercial administration of the licensing of the goods and services of others; providing business information relating to commercial business management via a web site; organization of exhibitions for commercial and advertising purposes of a variety of goods for others; import-export agency services; promoting the goods and services of others through advertisements on Internet websites.

**Application Number** 2,092,809  
**International Registration Number** 1582074  
**Language of Application** English

**Filing Date** 2021-01-26

## APPLICANT AND AGENT DETAILS

### Applicant

Jonathan Frank Palmer  
10 Groveland Way, Stotfold  
HITCHIN, Hertfordshire SG5 4PH  
UNITED KINGDOM

### Agent

PIASETZKI NENNIGER KVAS LLP  
SUITE 2308, 120 ADELAIDE STREET WEST,  
TORONTO, ONTARIO, M5H1T1

## TRADEMARK DETAILS

# Future Toys

### Trademark Type

Standard Characters

### Goods

#### Class 28

Battery operated remote controlled toy vehicles; battery operated remote controlled toy vehicles; battery operated action toys; children's four-wheeled vehicles [playthings]; children's ride-on toy vehicles; children's riding vehicles [playthings]; children's four-wheeled toy vehicles; children's ride-on toy vehicles; children's riding toy vehicles; children's toys, children's multiple activity toys; children's toy bicycles; multiple activity toys for children; electronic remote controlled toy vehicles; electronic remote controlled toy vehicles; electronic remote controlled toys, namely, cars, motorbikes, boats, airplanes, helicopters, space shuttles, go-karts and trains; electronic action toys; electronically operated toy motor vehicles; electronically operated toy vehicles; electronically-operated toy motor vehicles; electronic toys in the nature of talking electronic press-down toy; electronic action toys, mechanical toys, toy action figures; electronic learning toys; electronically operated toy motor vehicles; electronically operated toy vehicles; electronically-operated toy motor vehicles; go-karts (non motorised-); mechanical toys; model aircraft; model cars; model cars [toys or playthings]; plastic model kits for making toy vehicles; radio controlled model vehicles; radio controlled toy model cars; radio-controlled toy vehicles; radio-controlled toys; remote control toys; remote controlled flying toys; remote controlled scale model vehicles; remote control toys, namely, cars, motorbikes, boats, airplanes, helicopters, space shuttles, go-karts and trains in the form of vehicles; remote controlled flying toys, namely, airplanes, helicopters, space shuttles and drones; remote controlled scale model vehicles; remote controlled toys in the form of vehicles; remote-controlled submarines being toys; remote-controlled toys planes; remote-controlled toy robots; remote-controlled toy vehicles; ride-on toy vehicles; ride-on toy vehicles (motorised-); ride-on toys; scale model vehicles [toys]; scale-model vehicles; sit-in toy vehicles; toy aeroplanes; toy air vehicles; toy aircraft; toy airplanes; toy animals; toy artificial fingernails; toy bakeware; toy bakeware and toy cookware; toy balloons; toy balls; toy banks; toy beanbags [otedama]; toy bicycles; toy binoculars; toy birds; toy blocks; toy boats; toy bows and arrows; toy brooches; toy buckets and spades; toy building block sets; toy building blocks capable of interconnection; toy building components; toy buildings; toy butterfly nets; toy cable railways; toy cameras [not capable of taking a photograph]; toy camping apparatus; toy candy bowl mechanical dispensers; toy car

tracks; toy cars; toy model cars; toy model hobby craft kits; toy model kit cars; toy model train sets; toy model vehicles; toy models; toy pedal cars; toy robots; toy scooters; toy vehicles; toys, namely, action figures, stuffed animals, construction toys, creative toys in the nature of toy model kit cars, educational toys in the nature of an illustrated wall map, electronic toys in the nature of talking electronic press-down toy, food-related toys in then nature of toy food and wooden toys in the nature of positionable wooden figures for use in wooden puzzles ; toys simulating objects used by adults in day to day activity, namely, toy vacuum cleaners, toy kitchen sets, toys irons, toy microwaves and toy ovens ; trampolines; transforming robotic toy vehicles; radio-control; water squirting toys; wooden toys.

**Application Number** 2,092,826  
**International Registration Number** 1581843  
**Language of Application** English

**Filing Date** 2021-01-28

## APPLICANT AND AGENT DETAILS

### Applicant

Valmont Industries, Inc.  
15000 Valmont Plaza  
Omaha NE 68154  
UNITED STATES OF AMERICA

### Agent

STIKEMAN ELLIOTT LLP  
SUITE 1600, 50 O'CONNOR STREET,  
OTTAWA, ONTARIO, K1P6L2

## TRADEMARK DETAILS

# VALMONT

### Trademark Type

Standard Characters

### Services

#### Class 37

(1) Exterior pressure washing, disinfection and cleaning services performed by industrial drones; thermal imaging inspection services via drones in the course of construction, repair and cleaning of utilities transmission towers, sport and stadium lighting poles, and telecommunications towers

#### Class 39

(2) Piloting of civilian drones for aerial structural, sport lighting, and utility inspections.

#### Class 41

(3) Aerial photography for inspection purposes.

#### Class 42

(4) Consulting in the field of structural engineering, namely visual inspection services of structures, sport lighting, and utilities via drones

### Claims

Priority Filing Date: July 28, 2020, Country or Office: UNITED STATES OF AMERICA, Application No: 90078648 in association with the same kind of services

**Application Number** 2,093,100  
**Language of Application** English

**Filing Date** 2021-03-18

## **APPLICANT AND AGENT DETAILS**

### **Applicant**

L'or de Seraphine LLC  
1999 Circle Drive  
Suite B  
Cleveland, OH 44106  
UNITED STATES OF AMERICA

### **Agent**

AVENTUM IP LAW LLP  
Suite 104, Tower A, 555 Legget Drive, Ottawa,  
ONTARIO, K2K2X3

## **TRADEMARK DETAILS**

# **LA VIVE**

**Trademark Type**  
Standard Characters

**Goods**

**Class 04**

Candles



**Application Number** 2,093,305  
**Language of Application** English

**Filing Date** 2021-03-19

## APPLICANT AND AGENT DETAILS

### Applicant

The Not Company SpA  
El Peumo N° 284  
Santiago,  
CHILE

### Agent

DEETH WILLIAMS WALL LLP  
150 YORK STREET, SUITE 400, TORONTO,  
ONTARIO, M5H3S5

## TRADEMARK DETAILS

### Trademark Type

Design

### Visual Representation



### Colour Claim

Colour is claimed as a feature of the trademark. The colours black, blue, and purple are claimed as a feature of this mark. The mark consists of the image of a blue cow with a darker blue spot pattern and a purple nose and udder. A black bar is crossing through the cow diagonally.

### Goods

#### Class 29

Vegetable-based drink substitute, namely, plant-based dairy substitute

**Application Number** 2,094,260  
**Language of Application** English

**Filing Date** 2021-03-24

## APPLICANT AND AGENT DETAILS

### Applicant

Bevis Gear Inc.  
405-181 West 1st Avenue  
Vancouver  
BRITISH COLUMBIA  
V5Y0E3

### Agent

SMART & BIGGAR LP  
2300 - 1055 West Georgia Street, P.O. Box  
11115, Vancouver, BRITISH COLUMBIA,  
V6E3P3

## TRADEMARK DETAILS

# BEVISGEAR

### Trademark Type

Standard Characters

### Goods

#### Class 09

(1) Camera cases; camera bags; laptop bags

#### Class 10

(2) Medical response and rescue cases, namely, cases fitted for medical instruments, cases fitted for medical tools, and cases for medical and surgical instruments

#### Class 18

(3) Backpacks; tool bags; messenger bags; courier bags; diaper bags; gym bags; travel bags; all purpose carrying bags

#### Class 22

(4) Mail bags

#### Class 28

(5) Fishing tackle cases

**Application Number** 2,094,608  
**International Registration Number** 1582736  
**Language of Application** English

**Filing Date** 2021-02-02

## APPLICANT AND AGENT DETAILS

### Applicant

Polyver Sweden AB  
Pilgrimscenter  
SE-840 58 Pilgrimsstad  
SWEDEN

### Agent

BERESKIN & PARR LLP/S.E.N.C.R.L., S.R.L.  
SCOTIA PLAZA, 40 KING STREET WEST,  
40th FLOOR, TORONTO, ONTARIO, M5H3Y2

## TRADEMARK DETAILS

### Trademark Type

Design

### Visual Representation



### Goods

#### Class 06

(1) Shoe dowels of metal; crampons [climbing irons]; ice screws of metal

#### Class 09

(2) Shoes for protection against accidents; protective helmets for sports; fire protective clothing; protective headgear, namely, hard hats; protective industrial boots; safety boots

**Class 25**

(3) Boots; waterproof boots; tongues for shoes and boots; insoles [for shoes and boots]; footwear, namely shoes, sneakers, boots and insoles for footwear; rain boots; shoes; boots for sports; non-slipping devices for footwear, namely non-slip soles; non-slipping devices for boots, namely non-slip soles; ankle boots; work shoes; work boots; infants' boots; fishing boots; fishing footwear; half-boots; inner socks for footwear; mountaineering boots; climbing boots [mountaineering boots]; leather shoes; spiked running shoes; galoshes; plastic slippers; rainshoes; sandals; shoe soles for repair; snowboard shoes; snow boots; sports shoes; slippers; training shoes; walking shoes; waterproof shoes; winter boots; ski and snowboard shoes and parts thereof; sneakers; casual clothing, casual footwear, casual hats and caps, sports clothing, everyday clothing, outdoor winter clothing; cuffs; embossed soles of rubber or of plastic materials; embossed heels of rubber or of plastic materials; footwear uppers, namely shoes and boot uppers; pullstraps for shoes and boots; shoe covers, other than for medical purposes; shoe straps; stiffeners for boots; heels; heel protectors for shoes; welts for footwear; protective metal members for shoes and boots; soles for footwear; toe boxes; swim wear for gentlemen and ladies; blue jeans; belts made out of cloth; pants; gaiters; costumes, namely suits; down jackets; down vests; casual jackets; leisurewear; golf clothing, other than gloves; slipper socks; neckwear, namely neck warmers; wrist warmers; gloves [clothing]; men's and women's jackets, coats, trousers, vests; suspenders; jackets [clothing]; dresses made from skins; clothing of imitations of leather, namely belts, coats, gloves and jackets made from imitation leather; clothing for fishermen; short-sleeved t-shirts; leather dresses; leather belts [clothing]; furs coats and jackets; ear muffs [clothing]; coveralls; overcoats; parkas; polo shirts; polo sweaters; turtleneck sweaters; ponchos; sweaters; light-reflecting jackets; rainwear; riding jackets; coats; sailing wet weather clothing; shell jackets; snow suits; shirts; snow boarding suits; socks; stockings; sweatbands; surfwear; tee-shirts; tennis wear; tops and bottoms [clothing], namely knit tops and bottoms, fleece tops and bottoms, athletic tops and bottoms; gym suits; waterproof and windproof outdoor clothing; thermally insulated clothing, namely thermal underwear; wet suits; winter gloves; boots for motorcycling; functional underwear; hunting boot bags; leggings [leg warmers]; aprons [clothing]; printed t-shirts; sportswear; thermal headgear, namely thermal hats, thermal caps, thermal tuques and thermal headbands; wetsuit gloves; caps being headwear; hats; sports caps and hats; shawls and stoles; fleeces, namely fleece shirts, jackets, pants and vests; underwear; army boots; beach shoes

**Claims**

Priority Filing Date: January 28, 2021, Country or Office: EUIPO (EU), Application No: 018385357 in association with the same kind of goods

**Application Number** 2,095,227  
**Language of Application** English

**Filing Date** 2021-03-26

## APPLICANT AND AGENT DETAILS

### Applicant

PointsBet Pty Limited  
155 Cremorne Street  
Cremorne, Victoria, 3121  
AUSTRALIA

### Agent

GOWLING WLG (CANADA) LLP  
SUITE 1600, 1 FIRST CANADIAN PLACE, 100  
KING STREET WEST, TORONTO, ONTARIO,  
M5X1G5

## TRADEMARK DETAILS

# POINTS BET

### Trademark Type

Standard Characters

### Goods

#### Class 09

computer game software for playing online casino games; downloadable game software for use on computers and mobile devices for on-line gambling; downloadable mobile application for horse race betting; downloadable mobile application for playing online casino games; downloadable mobile application for sports betting; downloadable software for online sports betting;

### Services

#### Class 41

betting services; entertainment in the nature of fantasy sports leagues; gambling services; online casino gaming services; online gambling services; operation of betting platforms; providing non-downloadable casino games and video games via the Internet; sports betting services provided via an online betting platform; wagering services;

**Application Number** 2,096,205  
**International Registration Number** 1584060  
**Language of Application** English

**Filing Date** 2020-09-16

## APPLICANT AND AGENT DETAILS

### Applicant

Maplebear Inc.  
50 Beale Street, Suite 600  
San Francisco CA 94105  
UNITED STATES OF AMERICA

### Agent

GOWLING WLG (CANADA) LLP  
SUITE 1600, 1 FIRST CANADIAN PLACE, 100  
KING STREET WEST, TORONTO, ONTARIO,  
M5X1G5

## TRADEMARK DETAILS

### Trademark Type

Design

### Visual Representation



  
**Trademark Description**

The mark consists of a stylized design of a carrot.

**Goods****Class 25**

Clothing, namely, t-shirts, polo t-shirts, one piece garment for babies; hats, beanies, baseball caps; socks.

**Services****Class 45**

Personal shopping services for others, personal grocery shopping services for others, all of the foregoing excluding photo and video sharing and social networking services

**Claims**

Priority Filing Date: August 27, 2020, Country or Office: UNITED STATES OF AMERICA, Application No: 90143094 in association with the same kind of goods; September 12, 2020, Country or Office: UNITED STATES OF AMERICA, Application No: 90175811 in association with the same kind of services

**Application Number** 2,096,222  
**International Registration Number** 1583667  
**Language of Application** English

**Filing Date** 2020-10-12

## APPLICANT AND AGENT DETAILS

### Applicant

Dairy Crest Limited  
5 The Heights,  
Brooklands  
Weybridge, Surrey KT13 0NY  
UNITED KINGDOM

### Agent

SIMON LEMAY  
Saputo Inc., 6869 boul. Métropolitain Est,  
Montréal (Saint-Léonard), QUEBEC, H1P1X8

## TRADEMARK DETAILS

### Trademark Type

Design

### Visual Representation

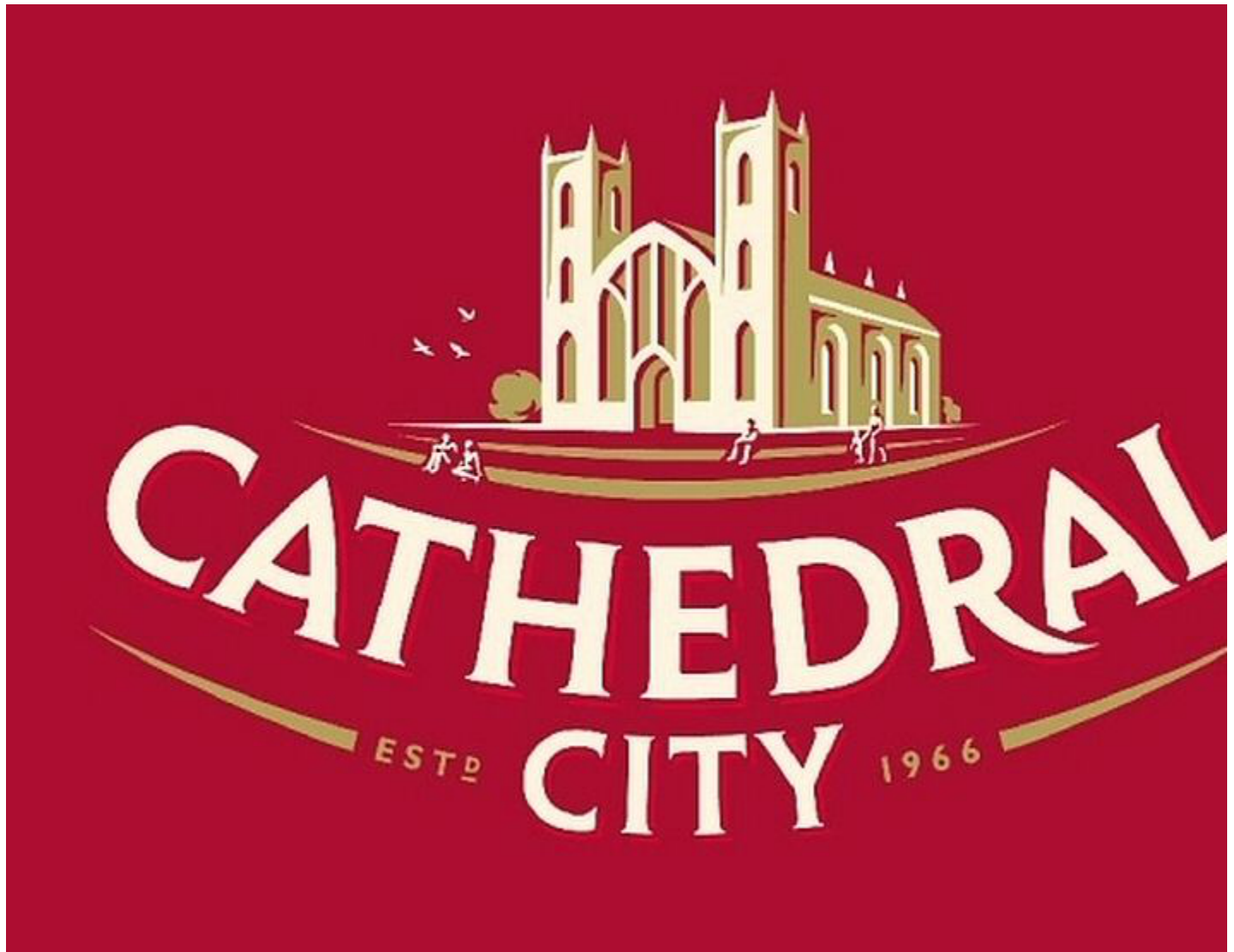



---

**Colour Claim**

Colour is claimed as a feature of the trademark. The words CATHEDRAL CITY are white. The words EST'D 1966 are golden. The facade of the drawing of the cathedral is white. The remainder of the drawing of the cathedral is golden. The drawing of the birds is white. The drawing of the characters is white. The drawing of the trees is golden. The drawing of the arcs of circles is golden.

**Goods****Class 29**

Dairy products; milk and milk products; milk predominating beverages; yoghurts; dairy cream; cheese spreads; butter; margarine; cheese; processed cheese; ready grated cheese; cheese dips; cheese products; cheese substitutes; prepared meals consisting primarily of cheese; snack dips; edible oils and edible fats; preserved and dried fruits and vegetables; jellies, jams, compotes.

**Application Number** 2,096,450  
**International Registration Number** 1583948  
**Language of Application** English

**Filing Date** 2021-02-01

## APPLICANT AND AGENT DETAILS

### Applicant

BFT Franchise Holdings, LLC  
17877 Von Karman Avenue  
Irvine CA 92614  
UNITED STATES OF AMERICA

### Agent

CASSELS BROCK & BLACKWELL LLP  
SCOTIA PLAZA, SUITE 2100, 40 KING  
STREET WEST, TORONTO, ONTARIO,  
M5H3C2

## TRADEMARK DETAILS

### Trademark Type

Design

### Visual Representation

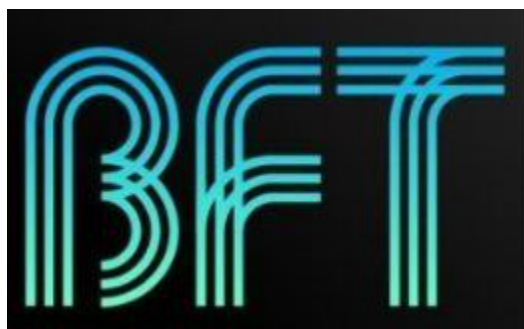

### Colour Claim

Colour is claimed as a feature of the trademark. The colours blue and green are claimed as a feature of the mark. The mark consists of the stylized letters "BFT" in blue fading to green towards the lower areas of the letters.

### Goods

#### Class 25

Athletic clothing; athletics footwear; athletics shoes; athletics shorts; athletics wear; bike pants; casual clothing; casual footwear; casual jackets; casual shirts; casual trousers; casualwear; jackets for casual wear; shoes for casual wear; clothing for gymnastics; clothing for sports; shoes; footwear for sport; sporting footwear; sports footwear; trainers (footwear); gym shorts; gymwear; headgear for wear, namely, hats, beanies, and toques; sports headgear (other than helmets), namely, sports caps; knitted clothing and knitwear (clothing), namely knit bottoms, knit dresses, knit skirts, knit jackets, knit shirts, knit sweaters, and knit tops; polo neck jumpers; polo shirts; polo sweaters; polo tops; leisure wear; baseball caps; caps (headwear); flat caps; sports caps; sports clothing (other than golf gloves); hooded sweatshirts; jumpers (sweaters); sports sweaters; sweat bands; sweat pants; sweat-absorbent underclothing; sweaters; sweatpants; sweatshirts; wristbands (sweatbands); track pants; track tops; tracksuits; clothing; headbands (clothing).

### Services

#### Class 35

(1) Administration of the business affairs of franchises; business advertising services relating to franchising, namely business advice relating to advertising; business advice relating to franchising; business advisory services relating to the establishment of franchises; business advisory services relating to the operation of franchises; business assistance relating to franchising; business assistance relating to the establishment of franchises; business consultancy relating to franchising; business consultation services relating to franchising; business franchising consultancy and business support services, namely, advice in the running of establishments as franchises; business franchising services (group purchasing, group advertising), namely, assistance in franchised commercial business management and providing marketing assistance relating to the operation of franchises; management advisory services related to franchising; provision of assistance (business) in the establishment of franchises; provision of assistance (business) in the operation of franchises; provision of business advice relating to franchising; provision of business information relating to franchising; promotion of goods and services of others through sponsorship of sports events

#### **Class 41**

(2) Gymnasium club services; gymnasium services; provision of gymnasium facilities; boot camp services (fitness training); conducting boot camp exercise classes; conducting fitness classes; fitness and exercise clinics, clubs and salons; health club services (health and fitness training); instruction in physical fitness; operation of physical fitness centres; personal trainer services (fitness training); physical fitness instruction; physical fitness training services; physical fitness tuition; conducting exercise classes; health club services (exercise); provision of apparatus for exercise; provision of exercise facilities; event management services in relation to the organisation of educational, entertainment, sporting or cultural events, namely event planning services; event planning in the field of sporting events; organisation of sporting activities in the field of physical fitness; providing online electronic publications (not downloadable), namely online publication of electronic periodicals; publication of electronic books and journals online; publication of journals; publication of magazines; publication of multimedia material online, namely, publishing of electronic publications; publication of periodicals; weblog (blog) services (online publication of journals or diaries), namely providing information in the field of journaling via an online blog and publication of online diaries via a blog

**Application Number** 2,096,459  
**International Registration Number** 1584295  
**Language of Application** English

**Filing Date** 2021-02-02

## APPLICANT AND AGENT DETAILS

### Applicant

NIKON CORPORATION  
2-15-3, Konan,  
Minato-ku  
Tokyo 108-6290  
JAPAN

### Agent

RIDOUT & MAYBEE LLP  
11 Holland Avenue, Suite 601 , Ottawa,  
ONTARIO, K1Y4S1

## TRADEMARK DETAILS

**Trademark Type**

Design

**Visual Representation**



**Goods**

**Class 09**

Range finders for cameras; rangefinders for golf; laser rangefinders; laser rangefinders for golf

**Claims**

Priority Filing Date: January 25, 2021, Country or Office: JAPAN, Application No: 2021-007609 in association with the same kind of goods

**Application Number** 2,096,460  
**International Registration Number** 1584287  
**Language of Application** English

**Filing Date** 2021-02-02

## APPLICANT AND AGENT DETAILS

### Applicant

NIKON CORPORATION  
2-15-3, Konan,  
Minato-ku  
Tokyo 108-6290  
JAPAN

### Agent

RIDOUT & MAYBEE LLP  
11 Holland Avenue, Suite 601 , Ottawa,  
ONTARIO, K1Y4S1

## TRADEMARK DETAILS

**Trademark Type**  
Design

**Visual Representation**

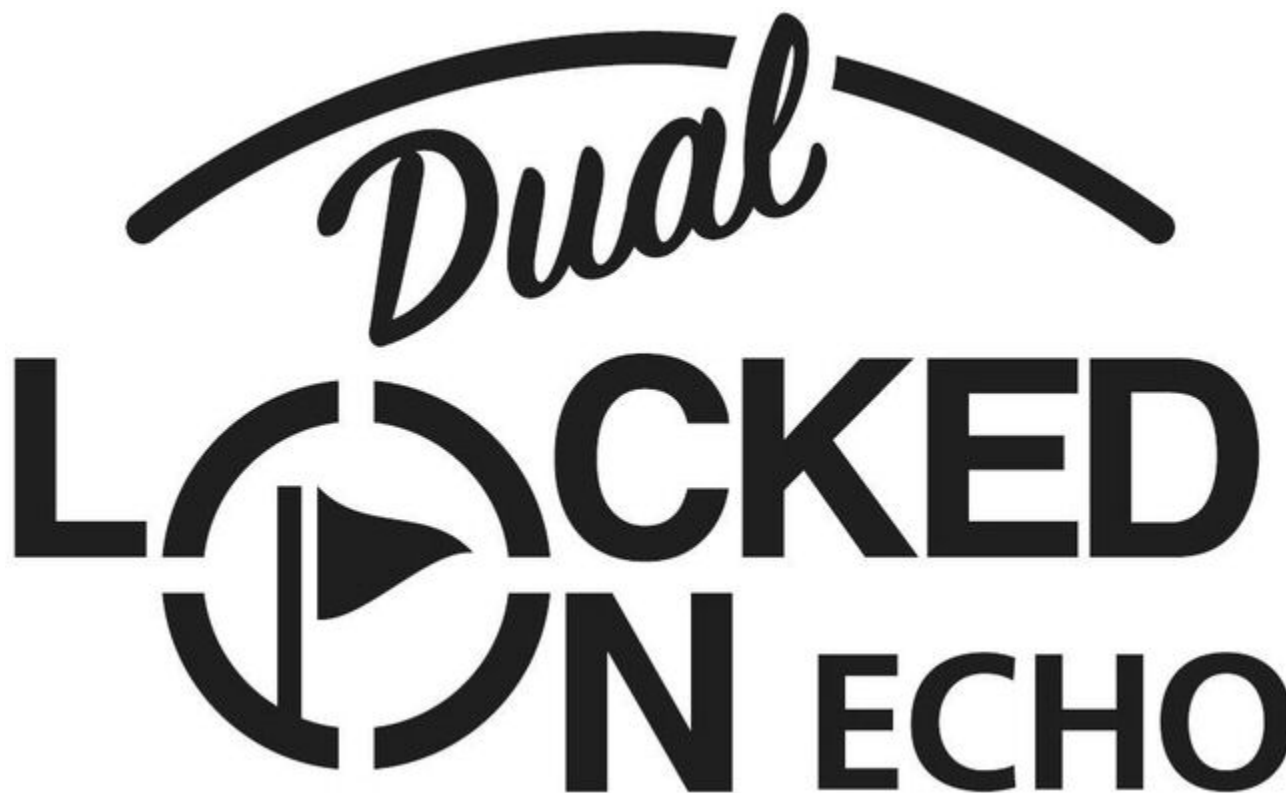

### Goods

#### Class 09

Range finders for cameras; rangefinders for golf; laser rangefinders; laser rangefinders for golf

### Claims

Priority Filing Date: January 25, 2021, Country or Office: JAPAN, Application No: 2021-007608 in association with the same kind of goods

**Application Number** 2,096,566  
**International Registration Number** 1584328  
**Language of Application** English

**Filing Date** 2021-02-17

## APPLICANT AND AGENT DETAILS

### Applicant

Citizen Watch Company of America, Inc.  
Empire State Building,  
350 Fifth Avenue, 29th Floor  
New York NY 10118  
UNITED STATES OF AMERICA

### Agent

GOWLING WLG (CANADA) LLP  
SUITE 2600, 160 ELGIN STREET, OTTAWA,  
ONTARIO, K1P1C3

## TRADEMARK DETAILS

# AQUALUXX

### Trademark Type

Standard Characters

### Goods

#### Class 14

Horological and chronometric instruments, namely, timepieces, movements for timepieces, and parts therefore; bands, bracelets and buckles for watches; watchmaking pendulums and suspension pendulums; watches

### Claims

Priority Filing Date: February 09, 2021, Country or Office: UNITED STATES OF AMERICA,  
Application No: 90521164 in association with the same kind of goods

**Application Number** 2,096,686  
**International Registration Number** 1461775  
**Language of Application** French

**Filing Date** 2021-03-12

## APPLICANT AND AGENT DETAILS

### Applicant

AARDEX GROUP, Société anonyme  
Rue Bois Saint-Jean 15/1  
B-4102 Seraing  
BELGIQUE

### Agent

BENOÎT & CÔTÉ INC.  
560 boul. Crémazie Est, 3e étage, Montréal,  
QUÉBEC, H2P1E8

## TRADEMARK DETAILS

# MedAmigo

### Trademark Type

Standard Characters

### Goods

#### Class 09

Scientific apparatus and instruments, namely recorders for timestamping related to medication intake and adherence to medication; apparatus for recording and processing information, namely recorders for timestamping related to medication intake and adherence to medication; apparatus and instruments for measuring and checking (supervision), for scientific use, namely recorders for timestamping related to medication intake and adherence to medication; data processing equipment, namely recorders for timestamping related to medication intake and adherence to medication; apparatus for recording, transmitting, processing and reproducing data, namely recorders for timestamping related to medication intake and adherence to medication; apparatus, namely computers and computer hardware for processing, transmitting and storing information in databases; apparatus for recording the time and date, namely recorders for timestamping related to medication intake and adherence to medication; downloadable software applications intended for use on mobile devices for measuring and monitoring adherence to medication and patients' compliance to medication plans; downloadable applications for mobile devices intended for managing and monitoring adherence to medication and patients' compliance to medication plans; memory units, namely microprocessors and microprocessor cards, intended for use with data processing apparatus; display screens, namely LCD screens; electronic data recorders for measuring, monitoring and managing adherence to medication and assisting patients to improve their adherence to medication; downloadable software, namely software for measuring and monitoring adherence to medication and patients' compliance to medication plans; downloadable compiler software; downloadable database management software; downloadable electronic publications, namely books, magazines and brochures in the field of adherence to medication; computer systems for processing medical data; downloadable software for cloud computing, namely software for managing and monitoring adherence to medication and patients' compliance to medication plans.

### Services

#### Class 42

Scientific and technological services, namely measuring and monitoring adherence to medication and patients' compliance to medication plans in the field of compliance with instructions related to health care; design and development of software; scientific evaluations, estimates, research and reports, related to measuring and monitoring adherence to medication and patients' compliance to medication plans in the field of compliance with instructions related to health care; technological and computer services related to the securing of computer data and personal and financial information and related to the detection of unauthorized access to patients' personal data and information in the field of compliance with instructions related to health care; scientific research services in the medical field; design, development, rental and programming of operating software enabling access to a cloud computing network as well as its use; digital compression of computer data; design of data processing apparatus for monitoring adherence to medication and patients' compliance to medication plans, namely electronic data recorders; design of computer databases; design, development, maintenance and updating of data processing software; design and development of medical software technologies in the field of compliance with instructions related to health care; development of data processing software; quality assessment of pharmaceutical preparations; research and development for the pharmaceutical industry.



**Application Number** 2,097,347  
**Language of Application** English

**Filing Date** 2021-04-06

## APPLICANT AND AGENT DETAILS

### Applicant

Fruit of the Loom, Inc., a New York corporation  
1 Fruit of the Loom Drive  
Bowling Green, KY 42103  
UNITED STATES OF AMERICA

### Agent

MARKS & CLERK  
33 Yonge Street, , Suite 300, Toronto,  
ONTARIO, M5E1G4

## TRADEMARK DETAILS

# COOLSOFT

### Trademark Type

Standard Characters

### Goods

#### Class 25

underwear, t-shirts, camisoles, bras, shirts, pants, shorts, jackets, and socks

### Claims

Priority Filing Date: March 31, 2021, Country or Office: UNITED STATES OF AMERICA,  
Application No: 90614926 in association with the same kind of goods

**Application Number** 2,097,739  
**Language of Application** English

**Filing Date** 2021-04-07

## APPLICANT AND AGENT DETAILS

**Applicant**

L'OREAL  
14 rue Royale  
Paris, 75008  
FRANCE

**Agent**

FASKEN MARTINEAU DUMOULIN LLP  
Tour de la Bourse, Suite 3500, P.O. box 242,  
800, Place Victoria, Montréal, QUEBEC,  
H4Z1E9

## TRADEMARK DETAILS

# H POUR HOMME

**Trademark Type**

Standard Characters

**Goods**

**Class 03**

Perfumes, eaux de toilette, body deodorants, soaps for personal use

**Application Number** 2,097,932  
**Language of Application** English

**Filing Date** 2021-04-07

## APPLICANT AND AGENT DETAILS

**Applicant**  
MARS CANADA INC.  
37 Holland Drive  
Bolton  
ONTARIO  
L7E5S4

**Agent**  
BAKER & MCKENZIE LLP  
BROOKFIELD PLACE, 181 BAY STREET,  
SUITE 2100, P.O. BOX 874, TORONTO,  
ONTARIO, M5J2T3

## TRADEMARK DETAILS

**Trademark Type**  
Design

**Visual Representation**



**Goods**  
**Class 31**  
edible pet treats; pet food;

**Application Number** 2,097,933  
**Language of Application** English

**Filing Date** 2021-04-07

## APPLICANT AND AGENT DETAILS

### Applicant

MARS CANADA INC.  
37 Holland Drive  
Bolton  
ONTARIO  
L7E5S4

### Agent

BAKER & MCKENZIE LLP  
BROOKFIELD PLACE, 181 BAY STREET,  
SUITE 2100, P.O. BOX 874, TORONTO,  
ONTARIO, M5J2T3

## TRADEMARK DETAILS

# NUTRO SO SIMPLE

### Trademark Type

Standard Characters

### Goods

#### Class 31

edible pet treats; pet food;

**Application Number** 2,097,955  
**International Registration Number** 1585136  
**Language of Application** English

**Filing Date** 2021-01-14

## APPLICANT AND AGENT DETAILS

### Applicant

Next2Sun GmbH  
Trierer Straße 22  
66663 Merzig  
GERMANY

### Agent

SMART & BIGGAR LP  
SUITE 900, 55 METCALFE STREET, P.O.  
BOX 2999, STATION D, OTTAWA, ONTARIO,  
K1P5Y6

## TRADEMARK DETAILS

# Next2Sun

### Trademark Type

Standard Characters

### Goods

#### Class 06

(1) Frame systems made of metal profiles made of steel, aluminum, iron, nickel, titanium and their alloys, designed to support vertically mounted and bifacial, photovoltaic modules and for use in photovoltaic systems; metal support structures for photovoltaic systems, namely, mounting structures primarily of metal for supporting solar cells, photovoltaic cells and solar collectors, in particular for supporting vertically oriented and bifacial photovoltaic modules, photovoltaic cells and solar collectors; fences and enclosures made of metal, designed to accommodate photovoltaic modules

#### Class 09

(2) Photovoltaic systems that convert sunlight into electrical and thermal energy, consisting of bifacial and vertically oriented photovoltaic modules; photovoltaic modules, in particular based on bifacial and vertically oriented photovoltaic cells; fences comprising and carrying photovoltaic modules; enclosures in the nature of photovoltaic systems that convert sunlight into electric and thermal energy comprising and carrying photovoltaic modules

### Services

#### Class 36

(1) Financial services, namely, acquisition of funds in the nature of venture capital financing for the realization of photovoltaic systems

#### Class 37

(2) Installation, cleaning, repair and maintenance of photovoltaic systems, in particular systems based on bifacial and vertically oriented photovoltaic modules; construction and assembly in the nature of installation of solar installations for generating power in the nature of photovoltaic modules and associated support structures and frames, in particular in open terrain; construction and assembly in the nature of installation in connection with the construction of photovoltaic systems, in particular in open terrain in the nature of installation of solar installations for generating power; carrying out landscaping measures, in particular compensatory measures in the terrain to

compensate for slopes, in connection with the construction of photovoltaic systems, namely, soil erosion control services and modification of terrain with construction machinery in the nature of excavation services for construction sites; construction project management services in the field of construction sites for the construction of photovoltaic systems

### **Class 42**

(3) Design and construction drafting of photovoltaic systems, in particular photovoltaic systems based on bifacial and vertically oriented photovoltaic modules; design and construction drafting of supporting structures and frames for photovoltaic systems; conceptual design of photovoltaic modules and photovoltaic systems, in particular in relation to vertically oriented and bifacial photovoltaic modules; implementation of technical project planning and project development in the nature of drafting and development of photovoltaic systems; technological utilization planning services in the nature of design of photovoltaic modules for photovoltaic systems, in particular vertically oriented and bifacial photovoltaic modules; provision of technical information on the use of photovoltaic systems in the nature of land use planning services, in particular on the basis of yield simulations and calculations for land use optimizing; project control and project management of land intended to be used for photovoltaic systems

### **Claims**

Priority Filing Date: July 14, 2020, Country or Office: GERMANY, Application No: 30 2020 109 590 in association with the same kind of goods and in association with the same kind of services

**Application Number** 2,098,362  
**Language of Application** English

**Filing Date** 2021-04-08

## APPLICANT AND AGENT DETAILS

**Applicant**  
Societe BIC  
12-22 boulevard Victor Hugo, 92110 CLICHY,  
FRANCE

**Agent**  
BERESKIN & PARR LLP/S.E.N.C.R.L., S.R.L.  
SCOTIA PLAZA, 40 KING STREET WEST,  
40th FLOOR, TORONTO, ONTARIO, M5H3Y2

## TRADEMARK DETAILS

**Trademark Type**  
Design

**Visual Representation**



**Goods**  
**Class 08**  
Shavers, namely razors and razor blades.

**Application Number** 2,099,067  
**Language of Application** English

**Filing Date** 2021-04-12

## APPLICANT AND AGENT DETAILS

### Applicant

Mr. Appliance SPV LLC  
1010 N. University Parks Drive  
Waco, TX 76707  
UNITED STATES OF AMERICA

### Agent

CASSELS BROCK & BLACKWELL LLP  
SCOTIA PLAZA, SUITE 2100, 40 KING  
STREET WEST, TORONTO, ONTARIO,  
M5H3C2

## TRADEMARK DETAILS

# SPEEDY EXPERT SERVICE

### Trademark Type

Standard Characters

### Services

#### Class 37

Installation, repair and refurbishment of household appliances



**Application Number** 2,099,104  
**Language of Application** English

**Filing Date** 2021-04-13

## **APPLICANT DETAILS**

### **Applicant**

Chengdu Smart Yunhai Optoelectronic  
Technology Co., LTD.  
No. 82, Taohua Street  
Chenghua District  
Chengdu, Sichuan, 610000  
CHINA

## **TRADEMARK DETAILS**

### **Trademark Type**

Design

### **Visual Representation**



### **Goods**

#### **Class 11**

lamp casings; led luminaires; electric track lighting units; lighting fixtures; floor lamps; led light bulbs; spotlights; reading lights; table lamps; wall lamps; lights for wall mounting.

**Application Number** 2,099,204  
**Language of Application** English

**Filing Date** 2021-04-13

## APPLICANT AND AGENT DETAILS

### Applicant

NEURALIUM INC.  
6185 boulevard Taschereau  
Local 118  
Office 225  
Brossard  
QUEBEC  
J4Z1A6

### Agent

ROBIC  
630, boul. René-Lévesque Ouest, 20e étage,  
Montréal, QUEBEC, H3B1S6

## TRADEMARK DETAILS

### Trademark Type

Design

### Visual Representation



### Colour Claim

Colour is claimed as a feature of the trademark. The word NEURALIUM is in purple; the dot of the letter "I" is in a shape of a leaf, in the colour green; the design on the left side of the word is the shape of a neuron, in purple and green.

### Services

#### Class 36

Financial services, namely provision of a cryptocurrency blockchain for digital currency exchange and trading services; financial consultation in the field of cryptocurrency.

**Application Number** 2,099,334  
**Language of Application** English

**Filing Date** 2021-04-13

## APPLICANT AND AGENT DETAILS

### Applicant

Gerbrands Medical Prof. Corp.  
1500-1874 Scarth St  
Regina  
SASKATCHEWAN  
S4P4E9

### Agent

FURMAN IP LAW & STRATEGY PC  
300 - 1914 HAMILTON STREET, REGINA,  
SASKATCHEWAN, S4P3N6

## TRADEMARK DETAILS

### Trademark Type

Design

### Visual Representation



### Foreign Character Translation

The translation provided by the applicant of the words De Haar is a hair.

### Goods

#### Class 03

(1) Hair care preparations; hair removal preparations

#### Class 05

(2) Hair growth preparations

### Services

#### Class 44

Cosmetic laser treatment for hair growth; Cosmetic laser treatment for removal of unwanted hair; Hair transplantation; Hair implantation, Non-surgical hair loss treatments; Hair Restoration services; Hair Replacement services; Platelet rich plasma therapy combined with micro needling for hair loss and hair rejuvenation, Hair growth preparations combined with micro needling for hair loss and hair rejuvenation; Cosmetic laser treatment for hair loss and hair rejuvenation; Micropigmentation for hair loss.

**Application Number** 2,099,340  
**Language of Application** English

**Filing Date** 2021-04-13

## APPLICANT AND AGENT DETAILS

### Applicant

Papaya Gaming Ltd.  
35 HaMasger St.  
Tel Aviv-Yafo, 6721407  
ISRAEL

### Agent

DENTONS CANADA LLP  
2500 Stantec Tower, 10220-103 Avenue NW,  
EDMONTON, ALBERTA, T5J0K4

## TRADEMARK DETAILS

# Bingo Cash

### Trademark Type

Standard Characters

### Goods

#### Class 09

Downloadable computer game software; downloadable interactive entertainment software for playing computer games; downloadable computer game software via a global computer network and wireless devices; computer game software downloadable from a global computer network; electronic game software for handheld electronic devices; computer game software for use on mobile and cellular phones; downloadable software in the nature of a mobile application for playing games.

**Application Number** 2,099,586  
**International Registration Number** 1586048  
**Language of Application** English

**Filing Date** 2020-10-30

## APPLICANT AND AGENT DETAILS

### Applicant

DAIKYO SEIKO, LTD.  
1305-1, Kurohakama-cho,  
Sano-shi  
Tochigi 327-0813  
JAPAN

### Agent

MARKS & CLERK  
33 Yonge Street, , Suite 300, Toronto,  
ONTARIO, M5E1G4

## TRADEMARK DETAILS

### Trademark Type

Design

### Visual Representation

**DAIKYO**

**Dynamic Innovation for Life**

### Colour Claim

Colour is claimed as a feature of the trademark. The entire trademark is in the colour blue.

### Goods

#### Class 10

(1) Structural parts for medical infusion instruments, namely, plugs, not of metal, used in caps that are structural parts for medical infusion instruments; structural parts for medical infusion instruments, namely, rubber stoppers used as structural parts for aqueous infusion instruments; structural parts for medicine inhaling instruments, namely, medical O-rings as structural parts used with medicine inhaling instruments; structural parts especially adapted for medical syringe needles, namely, rubber stoppers used as structural parts for medical vial bottles into which medical syringe needle is insertable; structural parts of medical syringes, namely, rubber stoppers especially adapted for injection solution cartridges, sold empty, which are structural fittings for pen-shaped medical syringes; medical syringes; injection syringes [syringe barrels] for medical purposes; structural parts of medical syringes, namely, pistons for medical syringes; structural parts of medical syringes, namely, plungers for medical syringes; structural parts of medical syringes, namely, nozzle caps for medical syringes; rubber stoppers for use with infusion devices for administering drugs for therapeutic purposes; structural parts of medical syringes, namely, medical

rubber caps for use with medical syringes for the injection of medicines; structural parts of medical syringes, namely, rubber stoppers and closures for medical syringes; containers especially adapted for the disposal of syringes; dropper bottles and droppers for administering medicines; connectors for infusion tubes and intravenous tubes; microplates for medical use; injection solution cartridges for medical syringe pens sold empty; vial-shaped plastic containers for medical purposes for use in storing parenteral drugs; syringe barrels with a needle for medical purposes in the nature of medical injection syringes; caps for syringe barrels with a needle for medical purposes in the nature of medical injection syringes; medical syringes, sold empty, of the type that pharmaceutical preparations are filled before their supply to end users in the nature of prefilled medical syringes; injection solution containers, sold empty, which are loaded and filled in medical syringe barrels in the nature of medical injection syringes and medical cartridge syringes; structural parts of syringes, namely, nozzle caps for needle-detachable syringes.

### **Class 17**

(2) O-rings of rubber; industrial packaging containers of rubber; rubber stoppers for medicine containers; rubber lids and caps for industrial packaging containers; rubber lids and caps for medicine containers; raw rubber and semi-worked rubber; rubber stoppers for industrial packaging containers; rubber stoppers for use with medical instruments; rubber stoppers for use in encapsulating medicinal solutions; rubber stoppers for medical microplates; rubber stoppers for medical infusion bags; rubber stoppers for medical infusion bottles; rubber stoppers specially adapted for medical blood collecting tubes.

### **Class 20**

(3) Packaging containers of plastic for use in storing medicines; packaging containers of plastic; medicine storage containers of plastic; plastic retaining caps for preventing rubber closures that seal mouths of containers for use in freezing and drying from coming off; plastic retaining caps for preventing rubber closures that seal mouths of packaging containers from coming off; plastic sealing caps with built-in rubber closure for sealing mouths of containers for use in freezing and drying; plastic sealing caps with built-in rubber closure for sealing mouths of packaging containers; plastic lids and caps for packaging containers; plastic caps for drug and medicine containers; rubber closures for medical infusion bags; rubber closures for medical infusion bottles; medical retaining caps not of metal for preventing rubber closures that seal mouths of medicine containers from coming off; medical sealing caps not of metal with built-in rubber closures for sealing mouths of medicine containers; rubber closures for medicine containers; rubber closures for use with medical vial containers; containers not of metal for the storage of medicines; packaging containers of plastic for the storage of infusion kits; packaging containers of plastic for the storage of intravenous solutions; packaging containers of plastic for the storage of parenteral medical solutions; rubber closures for medical vials; plastic stoppers for medical infusion bags; plastic stoppers for medical infusion bottles; rubber closures for medical containers used to store pharmaceutical raw materials and intermediate products; rubber closures for medical containers used to contain medicines, including pharmaceutical raw materials, intermediate products and final products; rubber closures for medical containers used to contain medicines; rubber closures for medical containers used to store pharmaceutical raw materials and pharmaceutical intermediates; packaging containers of plastic for medical instruments; medical plastic retaining caps for preventing rubber closures that seal mouths of vial containers for medicines from coming off; medical plastic sealing caps with built-in rubber closures for sealing mouths of vial containers for medicines.

### **Class 21**

(4) Vial-shaped plastic bottles; vial-shaped vessels for medicine; plastic bottles sold empty for medical use.

**Claims**

Priority Filing Date: October 23, 2020, Country or Office: JAPAN, Application No: 2020-131463 in association with the same kind of goods

**Application Number** 2,099,744  
**International Registration Number** 1586412  
**Language of Application** English

**Filing Date** 2021-02-03

## APPLICANT DETAILS

### Applicant

Privredno drustvo "IGMAN" d.d. Konjic  
Donje polje 42  
88400 Konjic  
BOSNIA AND HERZEGOVINA

## TRADEMARK DETAILS

### Trademark Type

Design

### Visual Representation



### Goods

Class 13

Firearms; ammunition; explosives.



**Application Number** 2,099,812  
**Language of Application** English

**Filing Date** 2021-04-14

## APPLICANT DETAILS

### Applicant

Wahter Studio Incorporated  
5195 Tydman Way  
Burlington  
ONTARIO  
L7L7B1

## TRADEMARK DETAILS

# Wahter

### Trademark Type

Standard Characters

### Goods

#### Class 25

A-shirts; adult pajamas; adult sweatpants; anti-perspirant socks; athletic apparel; athletic clothing; athletic footwear; athletic shoes; athletic shorts; athletic wear; balaclavas; bandanas; bandannas; baseball caps; baseball caps and hats; bath robes; bath sandals; bath slippers; bathing costumes; bathing costumes for women; bathing suits; bathing suits for men; bathing trunks; bathrobes; beach clothes; beach coats; beach cover-ups; beach pyjamas; beach robes; beach shoes; belts; belts made from imitation leather; belts made of leather; belts made out of cloth; belts of textile; blanket sleepers; blazers; blue jeans; bomber jackets; bomber vests; boots; boxer briefs; boxer shorts; boxing shorts; business attire; business clothing; caps; caps with visors; cardigans; cargo pants; cashmere jackets; cashmere sweaters; casual clothing; casual clothing featuring pants, dresses and shorts; casual footwear; casual pants; casual shirts; casual shoes; casual wear; children's clothing; coats; coats for men; coats for men and women; coats for women; coats made of cotton; coats of denim; denim coats; denim jackets; denim jeans; denim pants; denim shirts; down jackets; dress clothing; dress pants; dress shields for clothing; dress shirts; dress shoes; dress skirts; dress suits; dresses; dresses made from skins; dressing gowns; dressing gowns and bath robes; dust coats; duster coats; evening coats; evening dresses; evening footwear; evening gowns; exercise footwear; exercise wear; fabric belts; fashion hats; fleece jackets; fleece shirts; fleece shorts; fleece tops; fleece vests; gloves; golf caps; hats; head scarves; head sweatbands; headbands; heavy jackets; jackets; jackets and socks; jean jackets; jeans; jumpers; lab coats; leather jackets; long jackets; long sleeve pullovers; long sleeve shirts; long sleeved vests; long-sleeved t-shirts; loungewear; men's shirts; men's socks; men's underwear; muscle shirts; nightshirts; nightwear; one-piece bathing suits; open-necked shirts; outdoor winter clothing; pajama bottoms; pajamas; pants; parkas; pocket squares; polo shirts; promotional caps; promotional t-shirts; protective metal members for shoes and boots; pullovers; pyjamas; rain coats; rain jackets; rugby tops; running shoes; running shorts; scarves; shell jackets; shirts; shoes; short-sleeve shirts; short-sleeved shirts; short-sleeved t-shirts; shorts; skirts; sleeping garments; sleepwear; sleeved jackets; slipper socks; slippers; sneakers; snowboard jackets; soccer uniforms; socks; sun hats; sun protective clothing; sweat jackets; sweat pants; sweat shirts; sweat socks; sweat-absorbent socks; sweat-absorbent stockings; sweaters; sweatshirts; swim suits; t-shirts; tee-

shirts; tennis shirts; tennis shoes; tennis shorts; tennis wear; theatrical costumes; thermal socks; toques; turtleneck sweaters; undershirts; underwear; waterproof jackets; waterproof jackets and pants; winter coats; winter gloves; winter jackets; women's shirts; women's shoes; women's socks; women's underwear

**Services****Class 35**

(1) advertising agency services; advertising and business management consultancy; business consulting in the field of business networking; business management consultancy; consignment sale of art; fashion show exhibitions for commercial purposes; organisation of fashion shows for commercial purposes; organization of fashion shows for promotional purposes; production of advertising films for others; production of advertising materials for others; promoting the artwork of others by means of providing online portfolios via a website

**Class 41**

(2) arranging and conducting art exhibitions; arranging and conducting art shows; art exhibition services; art exhibitions; art exhibitions by galleries

Application Number 2,099,840  
International Registration Number 1586738  
Language of Application English

Filing Date 2021-02-24

## APPLICANT AND AGENT DETAILS

### Applicant

3B Trading LLC  
2000 E Country Club Dr  
Apt 1212  
Miami FL 33180  
UNITED STATES OF AMERICA

### Agent

CASSAN MACLEAN IP AGENCY INC.  
190 O'CONNOR STREET, SUITE 710,  
OTTAWA, ONTARIO, K2P2R3

## TRADEMARK DETAILS

### Trademark Type

Design

### Visual Representation



**THE  
BOTTLER  
IDEPOTI**

**Trademark Description**

The mark consists of wording partially encased within a border. The three words comprising the mark appear on three different lines. Appearing on the first line in the upper center space within the border is the word "THE". On the second line the word "BOTTLE" overlaps the center of the border, making it borderless towards the center. Between the two "T's" of the word "BOTTLE" there is a visual effect with the upper letter "H" that shows the form of a bottle within the letters. Finally on the third line appears the word "DEPOT". All fonts in regular bold type font, and sizes, except the middle word "BOTTLE" which is significantly bigger

**Disclaimer**

The right to the exclusive use of the word "BOTTLE" is disclaimed apart from the trademark.

**Goods****Class 21**

Plastic and glass bottles sold empty.

**Application Number** 2,099,946  
**International Registration Number** 1586101  
**Language of Application** English

**Filing Date** 2021-03-09

## APPLICANT AND AGENT DETAILS

### Applicant

Untether AI Corporation  
Suite 300, 134 Peter Street  
Toronto M5V 2H2  
CANADA

### Agent

OSLER, HOSKIN & HARCOURT LLP  
SUITE 6200, P.O. BOX 50, 1 FIRST  
CANADIAN PLACE, TORONTO, ONTARIO,  
M5X1B8

## TRADEMARK DETAILS

# tsunAlmi

### Trademark Type

Standard Characters

### Goods

#### Class 09

Compute accelerator cards with integrated circuits; circuit boards provided with integrated circuits; integrated circuit compute accelerator cards and standalone integrated circuits for compute acceleration; peripheral component interface (PCI) hardware

### Claims

Priority Filing Date: September 10, 2020, Country or Office: UNITED STATES OF AMERICA,  
Application No: 90171374 in association with the same kind of goods

**Application Number** 2,099,947  
**International Registration Number** 1586027  
**Language of Application** English

**Filing Date** 2021-03-09

## APPLICANT AND AGENT DETAILS

### Applicant

Untether AI Corporation  
Suite 300, 134 Peter Street  
Toronto M5V 2H2  
CANADA

### Agent

OSLER, HOSKIN & HARCOURT LLP  
SUITE 6200, P.O. BOX 50, 1 FIRST  
CANADIAN PLACE, TORONTO, ONTARIO,  
M5X1B8

## TRADEMARK DETAILS

# imAlgine

### Trademark Type

Standard Characters

### Goods

#### Class 09

Downloadable software development kits (SDK) for compiling neural networks and computer language code to run on compute accelerator cards and integrated circuits.

### Claims

Priority Filing Date: September 10, 2020, Country or Office: UNITED STATES OF AMERICA,  
Application No: 90171321 in association with the same kind of goods

**Application Number** 2,100,380  
**Language of Application** French

**Filing Date** 2021-04-16

## APPLICANT AND AGENT DETAILS

### Applicant

DISTILLERIE STADACONÉ INC.  
235, 2e Rue  
Québec  
QUÉBEC  
G1L2T2

### Agent

LAVERY DE BILLY S.E.N.C.R.L.  
925, Grande Allée Ouest, Bureau 500,  
Québec, QUÉBEC, G1S1C1

## TRADEMARK DETAILS

# MOJIGIN

### Trademark Type

Standard Characters

### Goods

#### Class 33

Premixed alcoholic cocktails.

**Application Number** 2,100,469  
**Language of Application** English

**Filing Date** 2021-04-16

## APPLICANT AND AGENT DETAILS

### Applicant

Gerbrands Medical Prof. Corp.  
1500-1874 Scarth St  
Regina  
SASKATCHEWAN  
S4P4E9

### Agent

FURMAN IP LAW & STRATEGY PC  
300 - 1914 HAMILTON STREET, REGINA,  
SASKATCHEWAN, S4P3N6

## TRADEMARK DETAILS

# DE HAAR

### Trademark Type

Standard Characters

### Foreign Character Translation

The translation provided by the applicant of the word DE HAAR is a hair.

### Goods

#### Class 03

(1) Hair care preparations; hair removal preparations

#### Class 05

(2) Hair growth preparations

### Services

#### Class 44

Cosmetic laser treatment for hair growth; Cosmetic laser treatment for removal of unwanted hair; Hair transplantation; Hair implantation, Non-surgical hair loss treatments; Hair Restoration services; Hair Replacement services; Platelet rich plasma therapy combined with micro needling for hair loss and hair rejuvenation, Hair growth preparations combined with micro needling for hair loss and hair rejuvenation; Cosmetic laser treatment for hair loss and hair rejuvenation; Micropigmentation for hair loss.



**Application Number** 2,101,435  
**International Registration Number** 1587783  
**Language of Application** English

**Filing Date** 2020-12-25

## APPLICANT AND AGENT DETAILS

### Applicant

RE-LEASED SOFTWARE COMPANY LIMITED  
Michael Taylor,  
Level 2,  
111 Wellesley Street West  
Auckland 1010  
NEW ZEALAND

### Agent

KATE HENDERSON  
128 Vine Avenue, Toronto, ONTARIO, M6P1V7

## TRADEMARK DETAILS

# CREDIA

### Trademark Type

Standard Characters

### Services

#### Class 35

(1) Business data analytics in the fields of real estate, commercial property management, and commercial real estate; market data analytics; market data analytics in the fields of real estate, commercial property management, and commercial real estate; advisory services relating to business analysis; business data analysis services in the fields of real estate, commercial property management, and commercial real estate; market research data analysis services; market research data analysis services in the fields of real estate, commercial property management, and commercial real estate; advisory services relating to business management; business consultancy in the fields of real estate, commercial property management, and commercial real estate; preparation and provision of business reports, business statistics and commercial reports; preparation and provision of business reports, business statistics and commercial reports and information in the fields of real estate, commercial property management, and commercial real estate; analysis of market research data and statistics; arranging and conducting trade shows and trade fairs in the fields of real estate, commercial property management, and commercial real estate; arranging and conducting trade shows and trade fairs on behalf of third-party businesses as a means of showcasing those third parties' goods and/or services; advertising agency services; advertising consultancy; promoting the goods and services of others through advertisements on Internet websites; publicity agency services; event planning and management for marketing, branding, promoting or advertising the goods and services of others; promoting the goods and services of others; promoting the goods and services of others by means of distributing advertising on the Internet; promoting the goods and services of others via a global computer network; promoting the sale of goods and services of others through the distribution of printed material; conducting an online trade show exhibition in the fields of commercial property management, and commercial real estate; conducting virtual trade show exhibitions online in the fields of commercial property management and commercial real estate; providing advice and information relating to commercial business management; providing business management information in connection

with consulting and advisory services in the field of strategic planning; providing business marketing information for others

#### **Class 41**

(2) Arranging and conducting seminars and workshops in the fields of real estate, commercial property management, and commercial real estate, and in respect of the use of technology in connection with real estate services; arranging and conducting educational conferences in the fields of real estate, commercial property management and commercial real estate; arranging, conducting and organization of on-line exhibitions, seminars and conferences in the fields of real estate, commercial property management, and commercial real estate; arranging and conducting business conferences

#### **Class 42**

(3) Application service provider featuring application programming interface (API) software for analyzing market data; providing temporary use of on-line non-downloadable software for use as an application programming interface (API) for use in the fields of real estate, commercial property management, and commercial real estate; application service provider (ASP) services featuring the hosting of computer software applications of others; application service provider (ASP) providing for integrations to services via application programming interfaces in the fields of real estate, commercial property management, and commercial real estate; software as a service, namely providing for integrations to services via application programming interfaces (APIs); software as a service, namely providing for integrations to services via application programming interfaces (APIs) in the fields of real estate, commercial property management, and commercial real estate; design and development of computer software, software applications, and application programming interfaces; design and development of computer software, software applications, and application programming interfaces in the field of application service provider (ASP) providing for integrations to services via application programming interfaces (APIs); consulting services in the field of software as a service (SaaS)

#### **Claims**

Priority Filing Date: June 26, 2020, Country or Office: NEW ZEALAND, Application No: 1152100 in association with the same kind of services

**Application Number** 2,101,654  
**International Registration Number** 1138967  
**Language of Application** English

**Filing Date** 2021-03-18

## APPLICANT AND AGENT DETAILS

### Applicant

Levitas S.p.A.  
Via Enrico Stendhal, 36  
I-20144 Milano (MI)  
ITALY

### Agent

ROBIC  
630, boul. René-Lévesque Ouest, 20e étage,  
Montréal, QUEBEC, H3B1S6

## TRADEMARK DETAILS

# BIKKEMBERGS

### Trademark Type

Standard Characters

### Goods

#### Class 14

(1) Jewellery; imitation jewellery; jewellery cases; watches; watch bands; watch cases; key chains; precious and semi-precious stones

#### Class 18

(2) Luggage; bags, namely, handbags, shoulder bags, carry-all bags, travelling bags, sport bags; backpacks; wallets; toiletry bags sold empty; umbrellas

#### Class 25

(3) Clothing, namely, shirts, T-shirts, polo shirts, sweatshirts, sweaters, jackets, coats, suits, trousers, shorts, dresses, skirts, blouses; underwear; beachwear; swimwear; neckwear; nightwear; loungewear; hosiery; socks; gloves; belts for clothing; textile face coverings, namely, face masks; footwear, namely, shoes; headgear, namely, hats and caps

**Application Number** 2,101,780  
**Language of Application** English

**Filing Date** 2021-04-22

## APPLICANT AND AGENT DETAILS

### Applicant

Qianglong Qiu  
Xiqiu Village, Jingfeng Town  
Huian County  
Quanzhou City, Fujian Province, 362000  
CHINA

### Agent

WITMART INC.  
34 King Street East, Suite 500, Toronto,  
ONTARIO, M5C2X8

## TRADEMARK DETAILS

# beufri

### Trademark Type

Standard Characters

### Goods

#### Class 25

sports footwear; casual footwear; Dresses; sweaters; trousers; women's suits; women's blouses; women's shirts; coats for women; t-shirts; Overcoats; Hats; socks and stockings; women's underwear; women's sportswear; women's ceremonial dresses; coats for men and women; women's foldable slippers; scarves; shoulder scarves

**Application Number** 2,101,823  
**Language of Application** English

**Filing Date** 2021-04-22

## **APPLICANT AND AGENT DETAILS**

### **Applicant**

JOENJON LLC  
765 HILLCREST PL, VALLEY STREAM  
New York, NY 11581  
UNITED STATES OF AMERICA

### **Agent**

BENOÎT & CÔTÉ INC.  
560 boul. Crémazie Est, 3e étage, Montréal,  
QUEBEC, H2P1E8

## **TRADEMARK DETAILS**

# **FOMI**

### **Trademark Type**

Standard Characters

### **Goods**

#### **Class 10**

Orthopedic seat cushions.

**Application Number** 2,101,952  
**Language of Application** English

**Filing Date** 2021-04-22

## **APPLICANT AND AGENT DETAILS**

### **Applicant**

2817334 Ontario Inc.  
181 Bay Street, Suite 2830,  
Toronto  
ONTARIO  
M5J2T3

### **Agent**

GOWLING WLG (CANADA) LLP  
SUITE 1600, 1 FIRST CANADIAN PLACE, 100  
KING STREET WEST, TORONTO, ONTARIO,  
M5X1G5

## **TRADEMARK DETAILS**

# **CUCINA BUCA**

### **Trademark Type**

Standard Characters

### **Foreign Character Translation**

The translation provided by the applicant of the words CUCINA and BUCA are CUISINE and HOLLOW.

### **Services**

#### **Class 43**

Restaurant services; Bar and lounge services; Take out restaurant services; Catering services.

**Application Number** 2,101,966  
**Language of Application** French

**Filing Date** 2021-04-22

## **APPLICANT DETAILS**

### **Applicant**

Erlaides Sanchez Perez et Neyci Milena  
Romana Sanchez  
3-80 Rue Majeau  
L'épiphanie  
QUÉBEC  
J5X0A5

## **TRADEMARK DETAILS**

# **wow mamacita**

### **Trademark Type**

Standard Characters

### **Foreign Character Translation**

The French translation provided by the applicant of the words WOW MAMACITA is WOW PETITE MAMAN.

### **Goods**

#### **Class 25**

Turbans.

**Application Number** 2,101,972  
**Language of Application** English

**Filing Date** 2021-04-22

## **APPLICANT DETAILS**

### **Applicant**

Organic Greek, LLC  
10120 Wexted Way  
Elk Grove, CA 95757  
UNITED STATES OF AMERICA

## **TRADEMARK DETAILS**

# **Vitamin Bottle**

### **Trademark Type**

Standard Characters

### **Disclaimer**

The right to the exclusive use of the word bottle is disclaimed apart from the trademark.

### **Goods**

#### **Class 11**

Water filtration bottles sold empty



**Application Number** 2,102,079  
**Language of Application** English

**Filing Date** 2021-04-23

## APPLICANT AND AGENT DETAILS

### Applicant

Mesa Packing, LLC  
510 Broadway Street  
King City, CA 93930  
UNITED STATES OF AMERICA

### Agent

BCF S.E.N.C.R.L./BCF LLP  
1100, boul. René-Lévesque Ouest, 25e Étage,  
Montréal, QUEBEC, H3B5C9

## TRADEMARK DETAILS

# FLORENTINO

### Trademark Type

Standard Characters

### Goods

#### Class 31

fresh vegetables, namely, sweet baby cauliflower

**Application Number** 2,102,135  
**Language of Application** French

**Filing Date** 2021-04-23

## **APPLICANT AND AGENT DETAILS**

### **Applicant**

LES CELLIERS JEAN D'ALIBERT  
Route de Pépieux, Routes Départementales 52  
et 115  
11160 Rieux-Minervois,  
FRANCE

### **Agent**

BCF S.E.N.C.R.L./BCF LLP  
1100, boul. René-Lévesque Ouest, 25e Étage,  
Montréal, QUÉBEC, H3B5C9

## **TRADEMARK DETAILS**

# **BIO BALTHAZAR**

### **Trademark Type**

Standard Characters

### **Goods**

#### **Class 33**

Wines.

**Application Number** 2,102,137  
**Language of Application** French

**Filing Date** 2021-04-23

## **APPLICANT AND AGENT DETAILS**

**Applicant**  
L'OREAL  
14 rue Royale  
75008 Paris,  
FRANCE

**Agent**  
FASKEN MARTINEAU DUMOULIN LLP  
Tour de la Bourse, Suite 3500, P.O. box 242,  
800, Place Victoria, Montréal, QUÉBEC,  
H4Z1E9

## **TRADEMARK DETAILS**

**Trademark Type**  
Design

**Visual Representation**

**GLOW  
PARADISI**

**Goods**  
**Class 03**  
Lipstick.

**Application Number** 2,102,142  
**Language of Application** English

**Filing Date** 2021-04-23

## APPLICANT AND AGENT DETAILS

### Applicant

Guayaki Sustainable Rainforest Products, Inc.  
6782 Sebastopol Avenue  
Sebastopol, CA 95472  
UNITED STATES OF AMERICA

### Agent

GOWLING WLG (CANADA) LLP  
SUITE 1600, 1 FIRST CANADIAN PLACE, 100  
KING STREET WEST, TORONTO, ONTARIO,  
M5X1G5

## TRADEMARK DETAILS

# ORANGE EXUBÉRANTE

### Trademark Type

Standard Characters

### Goods

#### Class 30

(1) non-alcoholic tea based beverages

#### Class 32

(2) energy drinks; fruit-flavored beverages; fruit-flavored beverages made with brewed yerba mate

**Application Number** 2,102,143  
**Language of Application** English

**Filing Date** 2021-04-23

## APPLICANT AND AGENT DETAILS

### Applicant

Guayaki Sustainable Rainforest Products, Inc.  
6782 Sebastopol Avenue  
Sebastopol, CA 95472  
UNITED STATES OF AMERICA

### Agent

GOWLING WLG (CANADA) LLP  
SUITE 1600, 1 FIRST CANADIAN PLACE, 100  
KING STREET WEST, TORONTO, ONTARIO,  
M5X1G5

## TRADEMARK DETAILS

# CITRON À PROFUSION

### Trademark Type

Standard Characters

### Goods

#### Class 30

(1) non-alcoholic tea based beverages

#### Class 32

(2) energy drinks; fruit-flavored beverages; fruit-flavored beverages made with brewed yerba mate

**Application Number** 2,102,144  
**Language of Application** English

**Filing Date** 2021-04-23

## APPLICANT AND AGENT DETAILS

### Applicant

Guayaki Sustainable Rainforest Products, Inc.  
6782 Sebastopol Avenue  
Sebastopol, CA 95472  
UNITED STATES OF AMERICA

### Agent

GOWLING WLG (CANADA) LLP  
SUITE 1600, 1 FIRST CANADIAN PLACE, 100  
KING STREET WEST, TORONTO, ONTARIO,  
M5X1G5

## TRADEMARK DETAILS

# BLEUPHORIE

### Trademark Type

Standard Characters

### Goods

#### Class 30

(1) non-alcoholic tea based beverages

#### Class 32

(2) energy drinks; fruit-flavored beverages; fruit-flavored beverages made with brewed yerba mate

**Application Number** 2,102,145  
**Language of Application** English

**Filing Date** 2021-04-23

## APPLICANT AND AGENT DETAILS

### Applicant

Guayaki Sustainable Rainforest Products, Inc.  
6782 Sebastopol Avenue  
Sebastopol, CA 95472  
UNITED STATES OF AMERICA

### Agent

GOWLING WLG (CANADA) LLP  
SUITE 1600, 1 FIRST CANADIAN PLACE, 100  
KING STREET WEST, TORONTO, ONTARIO,  
M5X1G5

## TRADEMARK DETAILS

# MENTHE VIVE

### Trademark Type

Standard Characters

### Goods

#### Class 30

(1) non-alcoholic tea based beverages

#### Class 32

(2) energy drinks; fruit-flavored beverages; fruit-flavored beverages made with brewed yerba mate

**Application Number** 2,102,148  
**Language of Application** English

**Filing Date** 2021-04-23

## APPLICANT AND AGENT DETAILS

### Applicant

Guayaki Sustainable Rainforest Products, Inc.  
6782 Sebastopol Avenue  
Sebastopol, CA 95472  
UNITED STATES OF AMERICA

### Agent

GOWLING WLG (CANADA) LLP  
SUITE 1600, 1 FIRST CANADIAN PLACE, 100  
KING STREET WEST, TORONTO, ONTARIO,  
M5X1G5

## TRADEMARK DETAILS

# GUAYAKI ORGANIC YERBA MATE CLASSIQUE DORÉ

### Trademark Type

Standard Characters

### Goods

#### Class 30

(1) Non-alcoholic tea based beverages

#### Class 32

(2) Energy drinks; fruit-flavored beverages; fruit-flavored beverages made with brewed yerba mate



**Application Number** 2,102,150  
**Language of Application** English

**Filing Date** 2021-04-23

## APPLICANT AND AGENT DETAILS

### Applicant

Guayaki Sustainable Rainforest Products, Inc.  
6782 Sebastopol Avenue  
Sebastopol, CA 95472  
UNITED STATES OF AMERICA

### Agent

GOWLING WLG (CANADA) LLP  
SUITE 1600, 1 FIRST CANADIAN PLACE, 100  
KING STREET WEST, TORONTO, ONTARIO,  
M5X1G5

## TRADEMARK DETAILS

# ÉVEIL TROPICAL

### Trademark Type

Standard Characters

### Goods

#### Class 30

(1) Non-alcoholic tea based beverages

#### Class 32

(2) Energy drinks; fruit-flavored beverages; fruit-flavored beverages made with brewed yerba mate

**Application Number** 2,102,170  
**Language of Application** French

**Filing Date** 2021-04-23

## APPLICANT AND AGENT DETAILS

**Applicant**  
DISTILLERIES CARTIER LTÉE  
3838, Boulevard Lemay  
Laval  
QUÉBEC  
H7E1A1

**Agent**  
RICHARD S. GAREAU  
2780, Mistassini, Laval, QUÉBEC, H7E3W1

## TRADEMARK DETAILS

**Trademark Type**  
Design

**Visual Representation**



**DOMINGO CASAL**

### Foreign Character Translation

The French translation provided by the applicant of the Portuguese words CASAL DOMINGO is COUPLE DU DIMANCHE.

### Goods

#### Class 32

(1) Beers; alcohol-free beers; alcohol-free ciders; alcohol-free cocktail mixes; alcohol-free wines; alcohol-free aperitifs; non-alcoholic coolers.

#### Class 33

(2) Alcoholic coolers; alcoholic cocktail mixes; ciders; wines; wine-based aperitifs; wine-based beverages; prepared wine-based cocktails; sparkling wines.

**Application Number** 2,102,171  
**Language of Application** French

**Filing Date** 2021-04-23

## **APPLICANT AND AGENT DETAILS**

**Applicant**  
DISTILLERIES CARTIER LTÉE  
3838, Boulevard Lemay  
Laval  
QUÉBEC  
H7E1A1

**Agent**  
RICHARD S. GAREAU  
2780, Mistassini, Laval, QUÉBEC, H7E3W1

## **TRADEMARK DETAILS**

**Trademark Type**  
Design

**Visual Representation**



**Goods****Class 32**

(1) Beers; alcohol-free beers; alcohol-free ciders; alcohol-free cocktail mixes; alcohol-free wines; alcohol-free aperitifs; non-alcoholic coolers.

**Class 33**

(2) Alcoholic coolers; alcoholic cocktail mixes; ciders; wines; wine-based aperitifs; wine-based beverages; prepared wine-based cocktails; sparkling wines.

**Application Number** 2,102,172  
**Language of Application** French

**Filing Date** 2021-04-23

## APPLICANT AND AGENT DETAILS

### Applicant

DISTILLERIES CARTIER LTÉE  
3838, Boulevard Lemay  
Laval  
QUÉBEC  
H7E1A1

### Agent

RICHARD S. GAREAU  
2780, Mistassini, Laval, QUÉBEC, H7E3W1

## TRADEMARK DETAILS

# CASAL DOMINGO

### Trademark Type

Standard Characters

### Foreign Character Translation

The French translation provided by the applicant of the Portuguese words CASAL DOMINGO is COUPLE DU DIMANCHE.

### Goods

#### Class 32

(1) Beers; alcohol-free beers; alcohol-free ciders; alcohol-free cocktail mixes; alcohol-free wines; alcohol-free aperitifs; non-alcoholic coolers.

#### Class 33

(2) Alcoholic coolers; alcoholic cocktail mixes; ciders; wines; wine-based aperitifs; wine-based beverages; prepared wine-based cocktails; sparkling wines.

**Application Number** 2,102,180  
**Language of Application** French

**Filing Date** 2021-04-23

## APPLICANT AND AGENT DETAILS

**Applicant**  
BROUE-ALLIANCE INC./BREW-ALLIANCE  
INC.  
3838 Boul Lemay  
Laval  
QUÉBEC  
H7E1A1

**Agent**  
RICHARD S. GAREAU  
2780, Mistassini, Laval, QUÉBEC, H7E3W1

## TRADEMARK DETAILS

# PEPITO

**Trademark Type**  
Standard Characters

### Goods

#### Class 32

(1) Beers; alcohol-free beers; alcohol-free ciders; alcohol-free cocktail mixes; alcohol-free wines; alcohol-free aperitifs; non-alcoholic coolers.

#### Class 33

(2) Alcoholic coolers; alcoholic cocktail mixes; ciders; wines; wine-based aperitifs; wine-based beverages; prepared wine-based cocktails; sparkling wines.

**Application Number** 2,102,181  
**Language of Application** French

**Filing Date** 2021-04-23

## APPLICANT AND AGENT DETAILS

**Applicant**  
BROUE-ALLIANCE INC./BREW-ALLIANCE  
INC.  
3838 Boul Leman  
Laval  
QUÉBEC  
H7E1A1

**Agent**  
RICHARD S. GAREAU  
2780, Mistassini, Laval, QUÉBEC, H7E3W1

## TRADEMARK DETAILS

**Trademark Type**  
Design

**Visual Representation**



### Goods

#### Class 32

(1) Beers; alcohol-free beers; alcohol-free ciders; alcohol-free cocktail mixes; alcohol-free wines; alcohol-free aperitifs; non-alcoholic coolers.

#### Class 33

(2) Alcoholic coolers; alcoholic cocktail mixes; ciders; wines; wine-based aperitifs; wine-based beverages; prepared wine-based cocktails; sparkling wines.

**Application Number** 2,102,195  
**Language of Application** English

**Filing Date** 2021-04-23

## APPLICANT AND AGENT DETAILS

### Applicant

Blockbuster L.L.C.  
9601 S. Meridian Blvd.  
Englewood, CO 80112  
UNITED STATES OF AMERICA

### Agent

GOWLING WLG (CANADA) LLP  
SUITE 2600, 160 ELGIN STREET, OTTAWA,  
ONTARIO, K1P1C3

## TRADEMARK DETAILS

# BE KIND, REWIND

### Trademark Type

Standard Characters

### Goods

#### Class 25

Shirts; t-shirts; sweatshirts; sweatpants; socks; hats; stocking hats; sleepwear; boxer briefs.

### Claims

Priority Filing Date: October 26, 2020, Country or Office: UNITED STATES OF AMERICA,  
Application No: 90/278,124 in association with the same kind of goods



**Application Number** 2,102,246  
**Language of Application** English

**Filing Date** 2021-04-23

## **APPLICANT AND AGENT DETAILS**

### **Applicant**

NATURE FRESH FARMS SALES INC.  
4 Seneca Drive,  
PO Box 400  
Leamington  
ONTARIO  
N8H3W5

### **Agent**

ROBIC  
630, boul. René-Lévesque Ouest, 20e étage,  
Montréal, QUEBEC, H3B1S6

## **TRADEMARK DETAILS**

# **OMBRÉCHERRY**

### **Trademark Type**

Standard Characters

### **Goods**

#### **Class 31**

Fresh fruits and vegetables; Fresh vegetables.

**Application Number** 2,102,461  
**Language of Application** English

**Filing Date** 2021-04-26

## APPLICANT AND AGENT DETAILS

### Applicant

Bank of Montreal  
1 First Canadian Place  
100 King Street West  
Toronto  
ONTARIO  
M5X1A1

### Agent

GOWLING WLG (CANADA) LLP  
SUITE 2600, 160 ELGIN STREET, OTTAWA,  
ONTARIO, K1P1C3

## TRADEMARK DETAILS

# BMO Insights

### Trademark Type

Standard Characters

### Services

#### Class 36

Online banking services accessible by means of downloadable mobile applications

**Application Number** 2,102,462  
**Language of Application** French

**Filing Date** 2021-04-26

## APPLICANT AND AGENT DETAILS

**Applicant**  
L'OREAL  
14 rue Royale  
Paris, 75008  
FRANCE

**Agent**  
FASKEN MARTINEAU DUMOULIN LLP  
Tour de la Bourse, Suite 3500, P.O. box 242,  
800, Place Victoria, Montréal, QUÉBEC,  
H4Z1E9

## TRADEMARK DETAILS

# TATTOO BROW LIFT STICK

**Trademark Type**  
Standard Characters

**Goods**  
**Class 03**  
Makeup.

**Application Number** 2,102,749  
**Language of Application** English

**Filing Date** 2021-04-27

## APPLICANT AND AGENT DETAILS

### Applicant

Jing Yao  
Rm 110, No.6, Hongmian 3rd Rd  
Longgang District  
Shenzhen, 518000  
CHINA

### Agent

ANITA MAR  
dba Trademark Angel, Suite 521, 6-2557  
Dougall Avenue, Windsor, ONTARIO, N8X1T5

## TRADEMARK DETAILS

# REKITA

### Trademark Type

Standard Characters

### Goods

#### Class 25

athletic clothing; baby clothing; blouses; body suits; bras; coats; hooded jackets; pants; shirts; skirts and dresses; sleepwear; sports bras; sports clothing; sweatshirts; swimsuits; t-shirts; wind coats; women's socks; women's underwear; yoga pants

**Application Number** 2,102,795  
**Language of Application** English

**Filing Date** 2021-04-27

## APPLICANT AND AGENT DETAILS

### Applicant

MATRIX INTEGRATED SOLUTIONS LTD.  
3075 14th Ave, Unit 15  
Markham  
ONTARIO  
L3R0G9

### Agent

JERRY CHEN  
JZC Intellectual Property Law, 166 Berwick  
Cres, Richmond Hill, ONTARIO, L4C0B4

## TRADEMARK DETAILS

# POS420

**Trademark Type**  
Standard Characters

### Services

**Class 36**

Cash management

**Application Number** 2,102,845  
**Language of Application** English

**Filing Date** 2021-04-28

## APPLICANT DETAILS

**Applicant**  
BECKO BROS. INC  
8713 LION ST  
RANCHO CUCAMONGA, CA 91730-4428  
UNITED STATES OF AMERICA

## TRADEMARK DETAILS

**Trademark Type**  
Design

**Visual Representation**

The logo for Beckos features the word "Beckos" in a bold, black, sans-serif font. The letters "Becko" are in a standard weight, while the "s" is significantly larger and more stylized, with a thick, rounded top and a small, curved tail. The entire word is set against a white background.

**Goods**

**Class 20**

tea cupboards [chadansu]; desks; office furniture; sideboards; filing cabinets; furniture cabinets; book cases; bedroom furniture; workbenches; display racks; tea carts; storage racks; standing desks; coffee tables; mirrors; living room furniture; kitchen furniture; furniture flower stands; tables

**Application Number** 2,102,958  
**Language of Application** English

**Filing Date** 2021-04-28

## APPLICANT AND AGENT DETAILS

### Applicant

Gran Coramino LLC  
3500 South Dupont Highway  
Dover, DE 19901  
UNITED STATES OF AMERICA

### Agent

BCF S.E.N.C.R.L./BCF LLP  
1100, boul. René-Lévesque Ouest, 25e Étage,  
Montréal, QUEBEC, H3B5C9

## TRADEMARK DETAILS

# GRAN CORAMINO

### Trademark Type

Standard Characters

### Foreign Character Translation

The translation provided by the applicant of the word GRAN is great.

### Goods

#### Class 33

Distilled blue agave liquor.

**Application Number** 2,102,959  
**Language of Application** English

**Filing Date** 2021-04-28

## APPLICANT AND AGENT DETAILS

### Applicant

Gran Coramino LLC  
3500 South Dupont Highway  
Dover, DE 19901  
UNITED STATES OF AMERICA

### Agent

BCF S.E.N.C.R.L./BCF LLP  
1100, boul. René-Lévesque Ouest, 25e Étage,  
Montréal, QUEBEC, H3B5C9

## TRADEMARK DETAILS

# GRAN KORAMINO

### Trademark Type

Standard Characters

### Foreign Character Translation

The translation provided by the applicant of the word GRAN is great.

### Goods

#### Class 33

Distilled blue agave liquor.



**Application Number** 2,103,096  
**International Registration Number** 1588148  
**Language of Application** English

**Filing Date** 2020-10-26

## APPLICANT AND AGENT DETAILS

### Applicant

MINUDO FARM-CARE ONE MEMBER  
LIMITED COMPANY  
No. 03/01 Bui Huu Nghia Street,  
Tan Thanh Ward,  
Buon Ma Thuot City  
Dak Lak Province  
VIET NAM

### Agent

NEOMARK LTD.  
7450 rue Saint-Hubert, Montréal, QUEBEC,  
H2R2N3

## TRADEMARK DETAILS

### Trademark Type

Design

### Visual Representation



**Colour Claim**

Colour is claimed as a feature of the trademark. The top part of the stylized letter A is green, the bottom part is brown. The word AEROCO is green with the exception of the stylized letter O which is brown. The word "coffee" is red.

**Disclaimer**

The right to the exclusive use of the word Coffee is disclaimed apart from the trademark.

**Goods****Class 30**

Coffee.

**Application Number** 2,103,305  
**International Registration Number** 1588711  
**Language of Application** English

**Filing Date** 2021-02-26

## APPLICANT AND AGENT DETAILS

### Applicant

FINESS CO., LTD.  
4F, Hakata Stella Building,  
8-35, Hakataekiminami,  
2-chome, Hakata-ku, Fukuoka-shi  
Fukuoka 812-0016  
JAPAN

### Agent

CYNTHIA D. MASON  
(Mason Professional Corporation), 1000  
Innovation Drive, Suite 500, Kanata,  
ONTARIO, K2K3E7

## TRADEMARK DETAILS

# sajiberry

### Trademark Type

Standard Characters

### Goods

#### Class 05

(1) Dietary supplements for general health and well-being.

#### Class 30

(2) Seasonings, other than spices; fruit-based sauces; tea; fruit teas; coffee; cocoa; cereal bars; noodles; pasta; fruit confectionery; fruit jelly candy.

#### Class 32

(3) Soft drinks; fruit-flavored soft drinks; fruit drinks and fruit juices.

**Application Number** 2,103,362  
**International Registration Number** 1588439  
**Language of Application** English

**Filing Date** 2021-03-12

## APPLICANT AND AGENT DETAILS

### Applicant

BLUE OCEAN BARNS INC.  
73-4460 Queen Ka'ahumanu Highway,  
Box 13  
Kailua-Kona HI 96740  
UNITED STATES OF AMERICA

### Agent

BCF S.E.N.C.R.L./BCF LLP  
1100, boul. René-Lévesque Ouest, 25e Étage,  
Montréal, QUEBEC, H3B5C9

## TRADEMARK DETAILS

# BROMINATA

### Trademark Type

Standard Characters

### Goods

#### Class 05

(1) Animal feed additives for use as nutritional supplements;

#### Class 31

(2) Unprocessed algae for animal feeding;

### Claims

Priority Filing Date: March 08, 2021, Country or Office: UNITED STATES OF AMERICA,  
Application No: 90565814 in association with the same kind of goods

**Application Number** 2,103,426  
**International Registration Number** 1588446  
**Language of Application** English

**Filing Date** 2021-03-28

## APPLICANT AND AGENT DETAILS

### Applicant

BDE Capital Pty Ltd  
84 McKinnon Road  
McKinnon VIC 3204  
AUSTRALIA

### Agent

FURMAN IP LAW & STRATEGY PC  
300 - 1914 HAMILTON STREET, REGINA,  
SASKATCHEWAN, S4P3N6

## TRADEMARK DETAILS

# Hey Bud

### Trademark Type

Standard Characters

### Goods

#### Class 03

Skincare cosmetics; cosmetics; hair cosmetics; cosmetic preparations for skin care; skin care creams; cosmetic skin care preparations; cosmetic oils for the skin; sun care lotions; body cleansers; non-medicated skin care lotions; non-medicated facial cleansers; non-medicated facial oils; non-medicated skin and facial moisturizers; non-medicated skin serums; non-medicated facial beauty masks.

### Claims

Priority Filing Date: March 25, 2021, Country or Office: AUSTRALIA, Application No: 2163418 in association with the same kind of goods

**Application Number** 2,103,484  
**Language of Application** English

**Filing Date** 2021-04-29

## **APPLICANT AND AGENT DETAILS**

### **Applicant**

Yiting Shen  
F#204, Huafeng Yuan, Chezhan Avenue,  
Lucheng District, Wenzhou City,  
Zhejiang Province, 325000  
CHINA

### **Agent**

MILTONS IP/P.I.  
#200-15 Fitzgerald Road, Ottawa, ONTARIO,  
K2H9G1

## **TRADEMARK DETAILS**

### **Trademark Type**

Design

### **Visual Representation**

**MALOVE |**

**Colour Claim**

Colour is claimed as a feature of the trademark. The word MALOVE MZ is black.

**Goods****Class 25**

scarves; hosiery; small hats; insoles; overshoes; boots; shoes; t-shirts; knitted shirts; suits.

**Application Number** 2,103,519  
**Language of Application** English

**Filing Date** 2021-04-29

## APPLICANT AND AGENT DETAILS

### Applicant

Colgate-Palmolive Canada Inc.  
Two Morneau Sobeco Centre  
6th Floor, 895 Don Mills Road  
Toronto  
ONTARIO  
M3C1W3

### Agent

SMART & BIGGAR LP  
1100-150 York street, TORONTO, ONTARIO,  
M5H3S5

## TRADEMARK DETAILS

# TOOTHPASTE RE:IMAGINED

### Trademark Type

Standard Characters

### Goods

#### Class 03

Non-medicated toothpaste



**Application Number** 2,103,563  
**Language of Application** English

**Filing Date** 2021-04-29

## APPLICANT AND AGENT DETAILS

### Applicant

SAMSUNG ELECTRONICS CO., LTD.  
129, SAMSUNG-RO, YEONGTONG-GU,  
SUWON-SI  
GYEONGGI-DO, 16677  
REPUBLIC OF KOREA

### Agent

SMART & BIGGAR LP  
SUITE 900, 55 METCALFE STREET, P.O.  
BOX 2999, STATION D, OTTAWA, ONTARIO,  
K1P5Y6

## TRADEMARK DETAILS

# Slim OTR

### Trademark Type

Standard Characters

### Goods

### Class 11

Electric cooking ovens for household purposes; Microwave ovens

**Application Number** 2,103,574  
**Language of Application** English

**Filing Date** 2021-04-29

## APPLICANT AND AGENT DETAILS

### Applicant

Elderton Wines Pty Ltd  
3-5 Tanunda Road  
Nuriootpa, SA, 5355  
AUSTRALIA

### Agent

MOFFAT & CO.  
P.O. Box 2088, Station D, Ottawa, ONTARIO,  
K1P5W3

## TRADEMARK DETAILS

# SMALL VICTORIES

### Trademark Type

Standard Characters

### Goods

#### Class 33

Wine

### Claims

Priority Filing Date: December 11, 2020, Country or Office: AUSTRALIA, Application No: 2142838  
in association with the same kind of goods

**Application Number** 2,103,669  
**Language of Application** English

**Filing Date** 2021-04-29

## APPLICANT AND AGENT DETAILS

### Applicant

153 KOREA Co., Ltd.  
17-17, Ihyeon-ro 30beon-gil, Giheung-gu  
Yongin-si  
Gyeonggi-do,  
REPUBLIC OF KOREA

### Agent

GOWLING WLG (CANADA) LLP  
SUITE 2600, 160 ELGIN STREET, OTTAWA,  
ONTARIO, K1P1C3

## TRADEMARK DETAILS

# CHEOGAJIP

### Trademark Type

Standard Characters

### Services

### Class 43

Restaurants; cafes; snack-bars; self-service restaurants; bar services; pubs.

**Application Number** 2,103,739  
**Language of Application** English

**Filing Date** 2021-04-29

## APPLICANT AND AGENT DETAILS

### Applicant

Yiwu Yige Import and Export Co., Ltd.  
Room 510, Floor 5, No. 509, Gongren North  
Road, Futian Street  
Yiwu, Zhejiang, 322000  
CHINA

### Agent

CABINET JURIDIQUE ST. LAWRENCE S.E.N.  
C.R.L.  
2301, Saint-Patrick Street, Suite B6, Montreal,  
QUEBEC, H3K1B3

## TRADEMARK DETAILS

### Trademark Type

Design

### Visual Representation



### Goods

#### Class 21

Bowls; dishes; soup bowls; Stew-pans; Cauldrons; Glue-pots; Knife rests for the table; Dishes; Cooking pots; non-electric griddles; camping grills; pepper grinders; manual meat grinder; manually operated coffee mills; Pie servers; non-electric autoclaves; cooking pots; manual egg beaters; non-electric kettles; non-electric deep fryers; ladles for kitchen use; kitchen enamelware; vacuum flasks; china dinnerware; drinking glasses; hand-operated coffee grinders; coffee sets; Non-electric coffee pots; Drying racks for laundry; Toothbrushes; Fitted vanity cases; Vacuum bottles.

**Application Number** 2,103,807  
**Language of Application** English

**Filing Date** 2021-04-30

## APPLICANT AND AGENT DETAILS

**Applicant**  
CHURCH & DWIGHT CO., INC.  
500 Charles Ewing Boulevard  
Ewing, NJ 08628  
UNITED STATES OF AMERICA

**Agent**  
BAKER & MCKENZIE LLP  
BROOKFIELD PLACE, 181 BAY STREET,  
SUITE 2100, P.O. BOX 874, TORONTO,  
ONTARIO, M5J2T3

## TRADEMARK DETAILS

**Trademark Type**  
Design

**Visual Representation**



**Goods**

**Class 03**

Shampoos for pets; wipes impregnated with cleansing preparations for pets.

**Application Number** 2,103,838  
**Language of Application** English

**Filing Date** 2021-04-30

## APPLICANT AND AGENT DETAILS

### Applicant

RIVELINO INC.  
46 Maurovista Court  
Stouffville  
ONTARIO  
L4A0E4

### Agent

JERRY CHEN  
JZC Intellectual Property Law, 166 Berwick  
Cres, Richmond Hill, ONTARIO, L4C0B4

## TRADEMARK DETAILS

# RIVELINO

### Trademark Type

Standard Characters

### Foreign Character Translation

The translation provided by the applicant of the Italian word "rivelino" is "reveal".

### Goods

#### Class 25

Suits, namely body suits, dress suits, ladies' suits, men's suits, pant suits, skirt suits, suit vests; coats; coats, namely coats for men and women, duffle coats, evening coats, trench coats, sports coats; shirts; shirts, namely shirts for suits, casual shirts, collared shirts, denim shirts, dress shirts, fleece shirts, long sleeve shirts, men's shirts, open-necked shirts, polo shirts, short-sleeve shirts, sport shirts; pants.

### Services

#### Class 40

Custom tailoring; custom clothing alteration.

Application Number 2,103,915  
Language of Application English

Filing Date 2021-04-30

## APPLICANT AND AGENT DETAILS

### Applicant

The little Farm distribucion S.L.  
Carrer Bruniquer 52  
Barcelona, 08024  
SPAIN

### Agent

MARK W. TIMMIS  
(MARK TIMMIS LAW CORPORATION), 2595  
CAVENDISH AVENUE, VICTORIA, BRITISH  
COLUMBIA, V8R2G5

## TRADEMARK DETAILS

### Trademark Type

Design

### Visual Representation



**Goods****Class 31**

Agricultural seeds; Grains for planting; Unprocessed seeds for agricultural purposes; Seeds for horticultural purposes; Bulbs for horticultural purposes



**Application Number** 2,103,930  
**Language of Application** English

**Filing Date** 2021-04-30

## APPLICANT AND AGENT DETAILS

### Applicant

YUET HEUNG YUEN LIMITED  
RM 1509, 15/F WORKINGBERG COMM  
BLDG 41-47 MARBLE RD  
NORTH POINT,  
HONG KONG

### Agent

MARK W. TIMMIS  
(MARK TIMMIS LAW CORPORATION), 2595  
CAVENDISH AVENUE, VICTORIA, BRITISH  
COLUMBIA, V8R2G5

## TRADEMARK DETAILS

### Trademark Type

Design

### Visual Representation

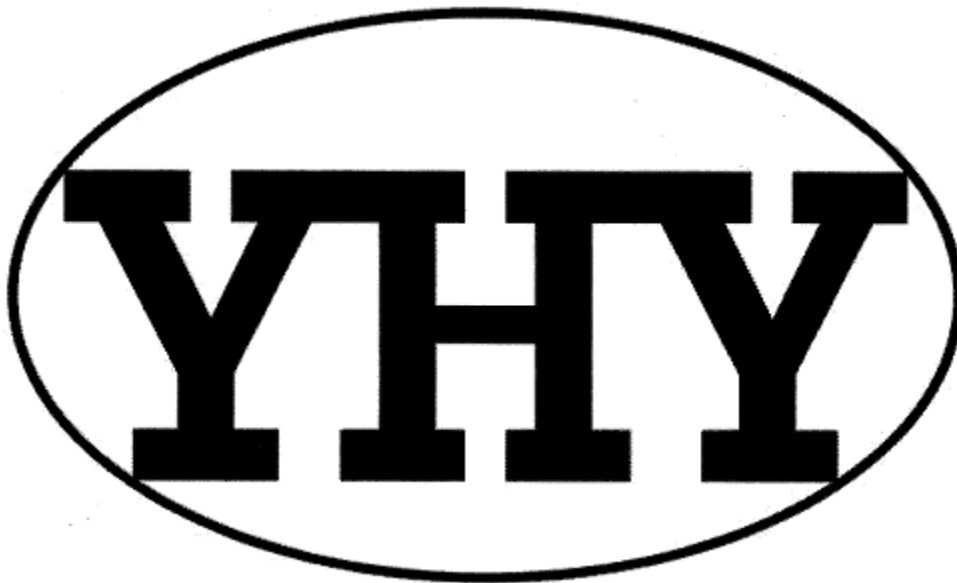

### Goods

#### Class 21

Lunch boxes; Soup bowls; Compostable plates; Disposable table plates; Serving spoons;  
Chopsticks; Toothbrushes; Bowls; Cups; Serving forks; Drinking straws

**Application Number** 2,104,155  
**Language of Application** English

**Filing Date** 2021-05-03

## APPLICANT AND AGENT DETAILS

### Applicant

Intertape Polymer Corp.  
100 Paramount Drive, Suite 300  
Sarasota, FL 34232  
UNITED STATES OF AMERICA

### Agent

FASKEN MARTINEAU DUMOULIN LLP  
Tour de la Bourse, Suite 3500, P.O. box 242,  
800, Place Victoria, Montréal, QUEBEC,  
H4Z1E9

## TRADEMARK DETAILS

# CURBY TAPE

### Trademark Type

Standard Characters

### Goods

#### Class 16

Water activated sealing tape; paper carton sealing tape

**Application Number** 2,104,356  
**Language of Application** English

**Filing Date** 2021-05-04

## APPLICANT AND AGENT DETAILS

### Applicant

Cytiva Sweden AB  
30 Bjorkgatan  
Uppsala, 75184  
SWEDEN

### Agent

BERESKIN & PARR LLP/S.E.N.C.R.L., S.R.L.  
SCOTIA PLAZA, 40 KING STREET WEST,  
40th FLOOR, TORONTO, ONTARIO, M5H3Y2

## TRADEMARK DETAILS

# AKTA

### Trademark Type

Standard Characters

### Goods

#### Class 28

Toy model kits; toy figures; toys, namely, construction toys, scale model kits, and scale model buildings.

**Application Number** 2,104,500  
**Language of Application** English

**Filing Date** 2021-05-05

## APPLICANT AND AGENT DETAILS

### Applicant

Universal Ibogaine Inc.  
303-595 Howe St  
Vancouver  
BRITISH COLUMBIA  
V6C2T5

### Agent

WITMART INC.  
34 King Street East, Suite 500, Toronto,  
ONTARIO, M5C2X8

## TRADEMARK DETAILS

# UNIVERSAL IBOGAINE

### Trademark Type

Standard Characters

### Services

#### Class 44

Addiction treatment services; drug addiction counselling services; medical clinic services; medical diagnostic services

**Application Number** 2,104,551  
**Language of Application** English

**Filing Date** 2021-05-05

## APPLICANT AND AGENT DETAILS

### Applicant

Lux Vending, LLC  
2875 Peachtree Road NW  
Suite 327  
Atlanta, GA 30305  
UNITED STATES OF AMERICA

### Agent

NORTON ROSE FULBRIGHT CANADA LLP/S.  
E.N.C.R.L.,S.R.L.  
COMPLEXE JULES-DALLAIRE/TOUR  
OGILVY RENAULT , BUREAU 1500, 2828,  
BOULEVARD LAURIER, QUÉBEC, QUEBEC,  
G1V0B9

## TRADEMARK DETAILS

### Trademark Type

Design

### Visual Representation



### Goods

#### Class 09

Automatic teller machines (ATM).

### Claims

Priority Filing Date: November 30, 2020, Country or Office: UNITED STATES OF AMERICA,  
Application No: 90/348,242 in association with the same kind of goods

**Application Number** 2,104,633  
**Language of Application** English

**Filing Date** 2021-05-05

## APPLICANT AND AGENT DETAILS

### Applicant

Kimberly-Clark Worldwide, Inc.  
401 North Lake Street  
P.O. Box 349  
Neenah, WI 54957-0349  
UNITED STATES OF AMERICA

### Agent

BORDEN LADNER GERVAIS LLP  
World Exchange Plaza, 100 Queen Street,  
Suite 1300, Ottawa, ONTARIO, K1P1J9

## TRADEMARK DETAILS

### Trademark Type

Design

### Visual Representation

— EZPULL —  
**1 HANDED**  
DISPENSING

---

### Goods

### Class 03

Baby wipes impregnated with cleaning preparations

**Application Number** 2,104,634  
**Language of Application** English

**Filing Date** 2021-05-05

## APPLICANT AND AGENT DETAILS

### Applicant

Kimberly-Clark Worldwide, Inc.  
401 North Lake Street  
P.O. Box 349  
Neenah, WI 54957-0349  
UNITED STATES OF AMERICA

### Agent

BORDEN LADNER GERVAIS LLP  
World Exchange Plaza, 100 Queen Street,  
Suite 1300, Ottawa, ONTARIO, K1P1J9

## TRADEMARK DETAILS

**Trademark Type**

Design

**Visual Representation**

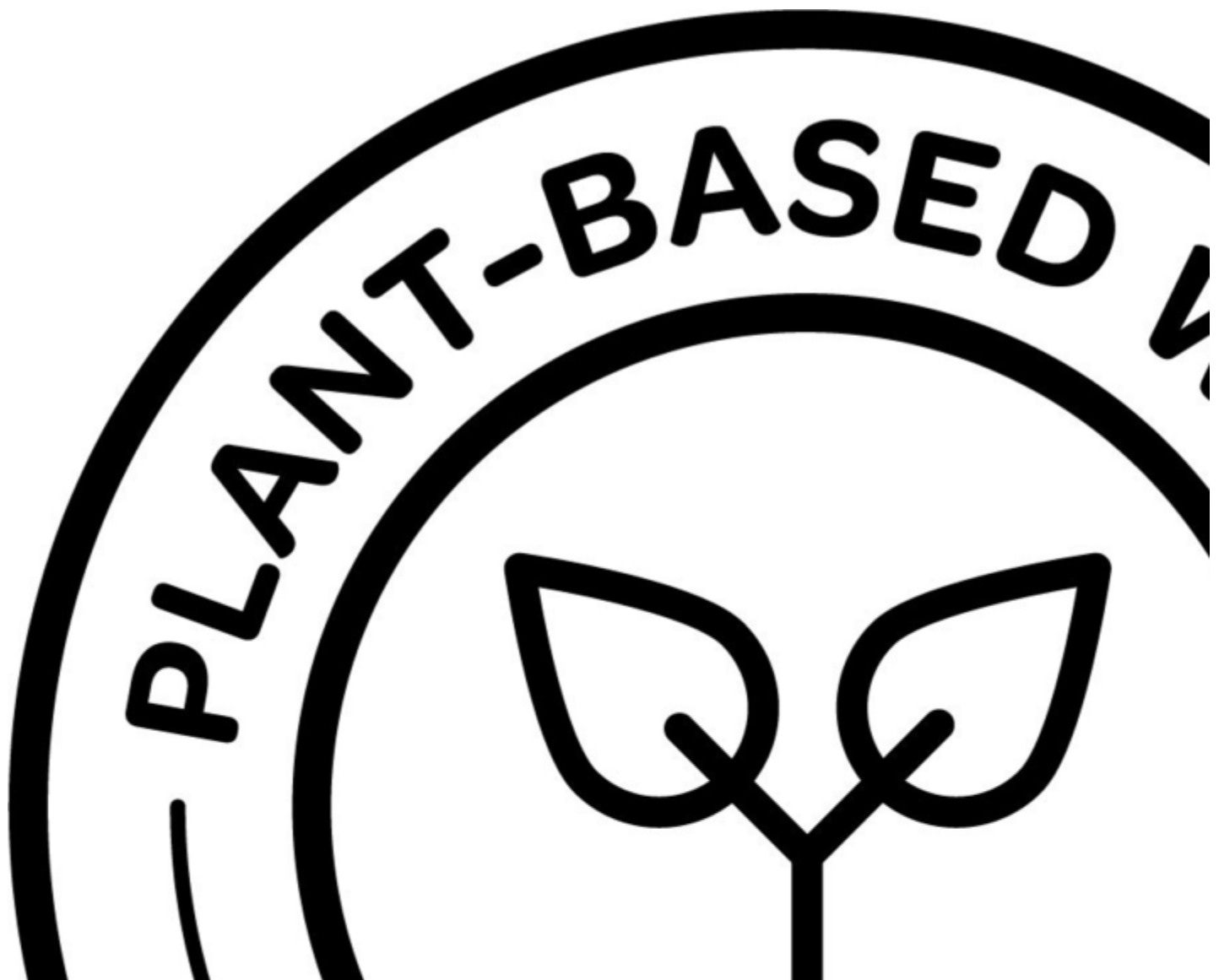



**Goods**

**Class 03**

Baby wipes impregnated with cleaning preparations



**Application Number** 2,104,637  
**Language of Application** English

**Filing Date** 2021-05-05

## APPLICANT AND AGENT DETAILS

### Applicant

Cameron Wells  
15947 Jetton Road  
Cornelius, NC 28031  
UNITED STATES OF AMERICA

### Agent

BORDEN LADNER GERVAIS LLP  
World Exchange Plaza, 100 Queen Street,  
Suite 1300, Ottawa, ONTARIO, K1P1J9

## TRADEMARK DETAILS

### Trademark Type

Design

### Visual Representation



**Goods**

**Class 03**

Skin soaps, moisturizing body lotions, skin and facial cleansers

**Claims**

Priority Filing Date: November 12, 2020, Country or Office: UNITED STATES OF AMERICA,  
Application No: 90/315,175 in association with the same kind of goods

**Application Number** 2,105,022  
**Language of Application** English

**Filing Date** 2021-05-05

## **APPLICANT AND AGENT DETAILS**

### **Applicant**

Indo Count Industries Limited  
No. 1, Plot No. 266  
Village Alte Kumbhoj Road  
Taluka Hatkanangale  
Kolhapur, Maharashtra, 416109  
INDIA

### **Agent**

WILSON LUE LLP  
250 University Avenue, 5th Floor, Toronto,  
ONTARIO, M5H3E5

## **TRADEMARK DETAILS**

# **THE LAZY SHEET**

### **Trademark Type**

Standard Characters

### **Goods**

#### **Class 24**

Bed sheets; pillowcases; shams; duvet covers.

**Application Number** 2,105,113  
**Language of Application** English

**Filing Date** 2021-05-05

## APPLICANT AND AGENT DETAILS

### Applicant

Shenzhen AJAZZ Tongchuang Electronic  
Technology Co.Ltd.  
Area C,2nd Floor,Building A  
No.30,Third Industrial District,Xia Cun  
Community  
Gongming Street,Guangming New District  
Shenzhen,Guangdong,  
CHINA

### Agent

MILTONS IP/P.I.  
#200-15 Fitzgerald Road, Ottawa, ONTARIO,  
K2H9G1

## TRADEMARK DETAILS

### Trademark Type

Design

### Visual Representation

The logo consists of the letters 'AJAZZ' in a bold, italicized, sans-serif font. The 'A' is significantly larger than the other letters and has a unique shape with a horizontal bar extending to the left. The 'J' is also stylized, and the 'Z's are bold and slanted.

### Colour Claim

Colour is claimed as a feature of the trademark. The trademark is composed of black English letters "AJAZZ"

### Goods

#### Class 09

card punching and sorting machines for data processing; recorded computer operating programs; computer keyboards; multifunction computer keyboards; computer mouse; mouse pads; sleeves for laptops; wrist rests for use with computers; multifunction keyboards; stands adapted for laptops; cabinets for loudspeakers; loudspeakers; microphones; headphones; headsets.

**Application Number** 2,105,128  
**Language of Application** English

**Filing Date** 2021-05-06

## APPLICANT DETAILS

### Applicant

Shenzhen DeMaXiYa Trading Co., Ltd.  
455, Gangshen International Center  
Xinniu Community, Minzhi Street, Longhua  
District  
Shenzhen, 518000  
CHINA

## TRADEMARK DETAILS

# FWJQA

### Trademark Type

Standard Characters

### Goods

#### Class 14

Bracelets; Clocks; Jewels; Medals; Wristwatches; Alarm clocks; Ankle bracelets; Charms for key rings; Jewelry brooches; Ear studs; Jewellery charms; Jewellery rolls; Jewelry findings; Key rings; Metal key rings; Necklaces; Paste jewellery; Pearls; Tie clips; Rings

**Application Number** 2,105,144  
**Language of Application** English

**Filing Date** 2021-05-06

## APPLICANT DETAILS

### Applicant

Xiaoxuan Xie  
No. 1201, Unit 3, Building 1, Xinbin Century  
Plaza  
No. 7 Jili West Road, Yuhu District  
Xiangtan, Hunan, 411100  
CHINA

## TRADEMARK DETAILS

# TNCXX

### Trademark Type

Standard Characters

### Goods

#### Class 21

Brushes for pets; Combs for animals; Pet bowls; Cat litter boxes; Soap dispensers; Cosmetic brushes; Make-up brushes; Make-up sponges; Food storage containers; Thermal insulated containers for food or beverages; Boxes for dispensing paper towels for household use; Bakeware; Candle holders; Water bottles sold empty; Clothes racks for drying; Non-electric whisks; Non-electric coffee percolators; Hand-operated coffee grinders and pepper mills; Vases; Bowls; Plates; Pots; Plug-in diffusers for mosquito repellents; Paper plates and paper cups

**Application Number** 2,105,175  
**Language of Application** English

**Filing Date** 2021-05-06

## APPLICANT AND AGENT DETAILS

**Applicant**  
MAKRITE INDUSTRIES INC.  
Rm. 5, 11 F., No. 79, Sec. 1, Xintai 5th Rd.,  
Xizhi Dist.,  
New Taipei City, 22101  
TAIWAN

**Agent**  
MACRAE & CO.  
326 Somerset Street West, Ottawa, ONTARIO,  
K2P0J9

## TRADEMARK DETAILS

**Trademark Type**  
Design

**Visual Representation**

The logo for Makrite features a large, bold, black letter 'M' on the left. To the right of the 'M', the word 'Makrite' is written in a bold, black, sans-serif font. The 'M' and the text are connected, with the 'M' being significantly larger than the letters in 'Makrite'.

## Goods

### Class 09

(1) divers' masks; dust protection masks; filters for respiratory masks; gas masks; masks for protection against dust; respiratory mask filters; welding masks; gloves for protection against x-rays for industrial purposes

### Class 10

(2) anaesthetic masks; cardiopulmonary resuscitation masks; cleanroom face masks; disposable sanitary masks for protection against viral infections; masks for use by medical personnel; oxygen masks for medical purposes; protective breathing masks for protection against viruses and germs; respiratory masks for artificial respiration; respiratory masks for medical purposes; resuscitation masks; reusable sanitary masks worn to cover the nose and mouth to prevent the spread of infection; sanitary face masks for protection against viral infections; sanitary masks for virus isolation purposes; sanitary masks worn to cover the nose and mouth to prevent the spread of infection; surgical masks



**Application Number** 2,105,209  
**Language of Application** English

**Filing Date** 2021-05-06

## APPLICANT AND AGENT DETAILS

### Applicant

BISSELL Inc.  
2345 Walker Ave NW  
Grand Rapids, MI 49544  
UNITED STATES OF AMERICA

### Agent

BORDEN LADNER GERVAIS LLP  
World Exchange Plaza, 100 Queen Street,  
Suite 1300, Ottawa, ONTARIO, K1P1J9

## TRADEMARK DETAILS

# TRACER

### Trademark Type

Standard Characters

### Goods

#### Class 07

vacuum cleaners

**Application Number** 2,105,237  
**Language of Application** English

**Filing Date** 2021-05-06

## APPLICANT AND AGENT DETAILS

### Applicant

Colgate-Palmolive Canada Inc.  
Two Morneau Sobeco Centre, 6th Floor  
895 Don Mills Road  
Toronto  
ONTARIO  
M3C1W3

### Agent

SMART & BIGGAR LP  
1100-150 York street, TORONTO, ONTARIO,  
M5H3S5

## TRADEMARK DETAILS

### Trademark Type

Design

### Visual Representation





**Goods**

**Class 03**

Non-medicated toothpaste

**Application Number** 2,105,253  
**Language of Application** English

**Filing Date** 2021-05-06

## APPLICANT AND AGENT DETAILS

### Applicant

Colgate-Palmolive Canada Inc.  
Two Morneau Sobeco Centre  
6th Floor, 895 Don Mills Road  
Toronto  
ONTARIO  
M3C1W3

### Agent

SMART & BIGGAR LP  
1100-150 York street, TORONTO, ONTARIO,  
M5H3S5

## TRADEMARK DETAILS

### Trademark Type

Design

### Visual Representation





**Goods**

**Class 03**

Non-medicated toothpaste

**Application Number** 2,105,259  
**Language of Application** English

**Filing Date** 2021-05-06

## APPLICANT AND AGENT DETAILS

### Applicant

Viña Almaviva S.A.  
Av. Santa Rosa 821, paradero 45  
Puente Alto  
Santiago,  
CHILE

### Agent

SMART & BIGGAR LP  
SUITE 900, 55 METCALFE STREET, P.O.  
BOX 2999, STATION D, OTTAWA, ONTARIO,  
K1P5Y6

## TRADEMARK DETAILS

### Trademark Type

Design

### Visual Representation

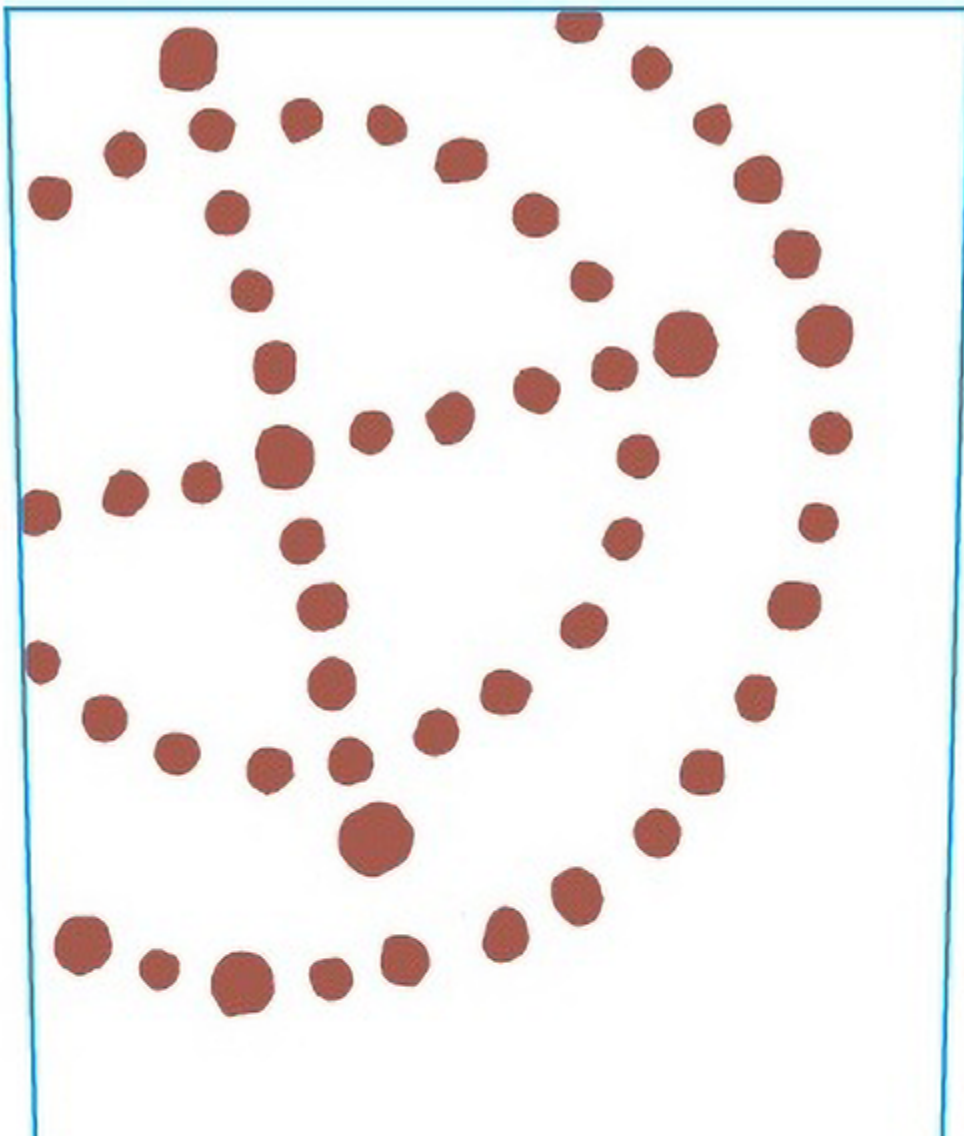

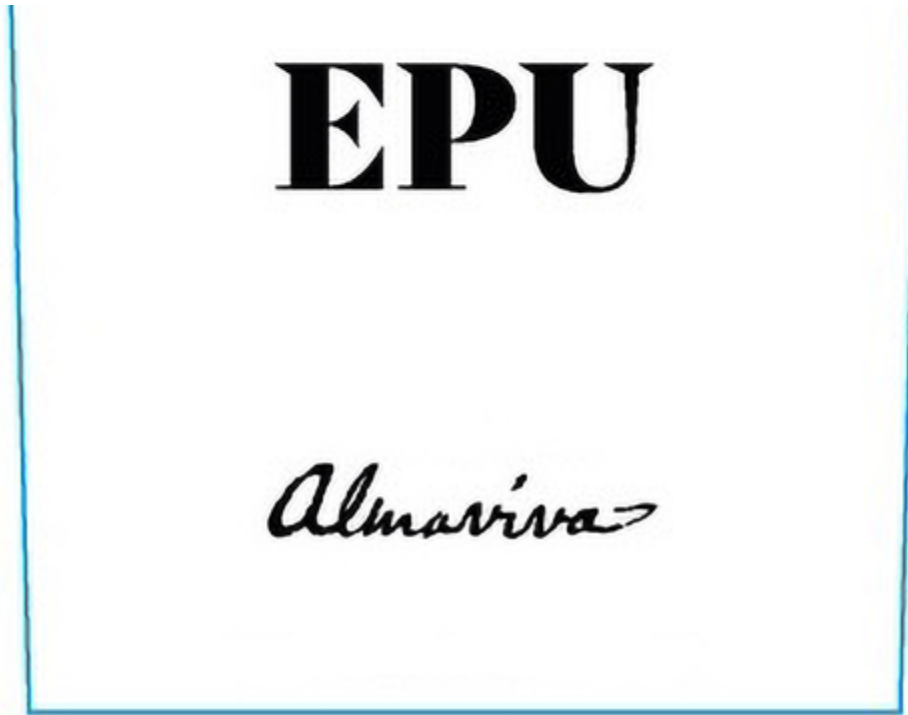
**Colour Claim**

Colour is claimed as a feature of the trademark. The terms "EPU" and "Almaviva" are black. The design element above the term "EPU" is brown. The border is blue. The entire design is on a white background.

**Foreign Character Translation**

The translation provided by the applicant of the Araucanian word EPU is TWO.

**Goods****Class 33**

Wines

**Application Number** 2,105,265  
**Language of Application** English

**Filing Date** 2021-05-06

## APPLICANT AND AGENT DETAILS

### Applicant

Jennifer Jurkofsky  
2-106 Smirle Ave.  
Ottawa  
ONTARIO  
K1Y0S3

### Agent

DEETH WILLIAMS WALL LLP  
150 YORK STREET, SUITE 400, TORONTO,  
ONTARIO, M5H3S5

## TRADEMARK DETAILS

# MY HOLISTIC SELF

### Trademark Type

Standard Characters

### Services

#### Class 44

Psychological Counselling services



**Application Number** 2,105,293  
**Language of Application** English

**Filing Date** 2021-05-06

## APPLICANT AND AGENT DETAILS

### Applicant

Pixelle Specialty Solutions LLC  
228 South Main Street  
Spring Grove, PA 17362  
UNITED STATES OF AMERICA

### Agent

DEETH WILLIAMS WALL LLP  
150 YORK STREET, SUITE 400, TORONTO,  
ONTARIO, M5H3S5

## TRADEMARK DETAILS

# POINTWRAP

### Trademark Type

Standard Characters

### Goods

#### Class 16

Paper, namely, gift wrap paper

### Claims

Priority Filing Date: December 22, 2020, Country or Office: UNITED STATES OF AMERICA,  
Application No: 90/402,981 in association with the same kind of goods

**Application Number** 2,105,294  
**Language of Application** English

**Filing Date** 2021-05-06

## APPLICANT AND AGENT DETAILS

### Applicant

Pixelle Specialty Solutions LLC  
228 South Main Street  
Spring Grove, PA 17362  
UNITED STATES OF AMERICA

### Agent

DEETH WILLIAMS WALL LLP  
150 YORK STREET, SUITE 400, TORONTO,  
ONTARIO, M5H3S5

## TRADEMARK DETAILS

# POINTGUARD

### Trademark Type

Standard Characters

### Goods

#### Class 16

Paper, namely, anti-wick paper designed for bright white labels and wristbands

### Claims

Priority Filing Date: December 22, 2020, Country or Office: UNITED STATES OF AMERICA,  
Application No: 90/402,956 in association with the same kind of goods

**Application Number** 2,105,297  
**Language of Application** English

**Filing Date** 2021-05-06

## APPLICANT AND AGENT DETAILS

### Applicant

Pixelle Specialty Solutions LLC  
228 South Main Street  
Spring Grove, PA 17362  
UNITED STATES OF AMERICA

### Agent

DEETH WILLIAMS WALL LLP  
150 YORK STREET, SUITE 400, TORONTO,  
ONTARIO, M5H3S5

## TRADEMARK DETAILS

# POINTFLEX

### Trademark Type

Standard Characters

### Goods

#### Class 16

Paper, namely, flexible packaging paper designed for laminated packages

### Claims

Priority Filing Date: January 19, 2021, Country or Office: UNITED STATES OF AMERICA,  
Application No: 90/473,694 in association with the same kind of goods

**Application Number** 2,105,299  
**Language of Application** English

**Filing Date** 2021-05-06

## APPLICANT AND AGENT DETAILS

### Applicant

Medline Industries, LP  
Three Lakes Drive  
Northfield, IL 60093  
UNITED STATES OF AMERICA

### Agent

DEETH WILLIAMS WALL LLP  
150 YORK STREET, SUITE 400, TORONTO,  
ONTARIO, M5H3S5

## TRADEMARK DETAILS

# IOPLEX

### Trademark Type

Standard Characters

### Goods

#### Class 05

Wound dressings.

**Application Number** 2,105,300  
**Language of Application** English

**Filing Date** 2021-05-06

## APPLICANT AND AGENT DETAILS

### Applicant

Pixelle Specialty Solutions LLC  
228 South Main Street  
Spring Grove, PA 17362  
UNITED STATES OF AMERICA

### Agent

DEETH WILLIAMS WALL LLP  
150 YORK STREET, SUITE 400, TORONTO,  
ONTARIO, M5H3S5

## TRADEMARK DETAILS

# POINTSIL

### Trademark Type

Standard Characters

### Goods

#### Class 16

Paper, namely, silicone release liner base sheet paper

### Claims

Priority Filing Date: January 21, 2021, Country or Office: UNITED STATES OF AMERICA,  
Application No: 90/479,277 in association with the same kind of goods

**Application Number** 2,105,301  
**Language of Application** English

**Filing Date** 2021-05-06

## APPLICANT AND AGENT DETAILS

### Applicant

Pixelle Specialty Solutions LLC  
228 South Main Street  
Spring Grove, PA 17362  
UNITED STATES OF AMERICA

### Agent

DEETH WILLIAMS WALL LLP  
150 YORK STREET, SUITE 400, TORONTO,  
ONTARIO, M5H3S5

## TRADEMARK DETAILS

# GLAZELID

### Trademark Type

Standard Characters

### Goods

#### Class 16

Paper, namely, uncoated paper base sheet

### Claims

Priority Filing Date: December 22, 2020, Country or Office: UNITED STATES OF AMERICA,  
Application No: 90/402,897 in association with the same kind of goods

**Application Number** 2,105,302  
**Language of Application** English

**Filing Date** 2021-05-06

## APPLICANT AND AGENT DETAILS

### Applicant

Pixelle Specialty Solutions LLC  
228 South Main Street  
Spring Grove, PA 17362  
UNITED STATES OF AMERICA

### Agent

DEETH WILLIAMS WALL LLP  
150 YORK STREET, SUITE 400, TORONTO,  
ONTARIO, M5H3S5

## TRADEMARK DETAILS

# POINTMATT

### Trademark Type

Standard Characters

### Goods

#### Class 16

Paper, namely, flexible packaging paper designed for laminated packages

### Claims

Priority Filing Date: December 22, 2020, Country or Office: UNITED STATES OF AMERICA,  
Application No: 90/402,972 in association with the same kind of goods

**Application Number** 2,105,303  
**Language of Application** English

**Filing Date** 2021-05-06

## APPLICANT AND AGENT DETAILS

### Applicant

Pixelle Specialty Solutions LLC  
228 South Main Street  
Spring Grove, PA 17362  
UNITED STATES OF AMERICA

### Agent

DEETH WILLIAMS WALL LLP  
150 YORK STREET, SUITE 400, TORONTO,  
ONTARIO, M5H3S5

## TRADEMARK DETAILS

# OPTITHERM

### Trademark Type

Standard Characters

### Goods

#### Class 16

Paper, namely, thermal base sheet paper

### Claims

Priority Filing Date: December 22, 2020, Country or Office: UNITED STATES OF AMERICA,  
Application No: 90/402,948 in association with the same kind of goods



**Application Number** 2,105,305  
**Language of Application** English

**Filing Date** 2021-05-06

## APPLICANT AND AGENT DETAILS

### Applicant

Pixelle Specialty Solutions LLC  
228 South Main Street  
Spring Grove, PA 17362  
UNITED STATES OF AMERICA

### Agent

DEETH WILLIAMS WALL LLP  
150 YORK STREET, SUITE 400, TORONTO,  
ONTARIO, M5H3S5

## TRADEMARK DETAILS

# GLAZEARMOR

### Trademark Type

Standard Characters

### Goods

#### Class 16

Paper, namely, uncoated machine-glazed oil and grease-resistant paper designed for food and industrial packaging

### Claims

Priority Filing Date: December 22, 2020, Country or Office: UNITED STATES OF AMERICA,  
Application No: 90/402,893 in association with the same kind of goods

**Application Number** 2,105,307  
**Language of Application** English

**Filing Date** 2021-05-06

## APPLICANT AND AGENT DETAILS

### Applicant

Pixelle Specialty Solutions LLC  
228 South Main Street  
Spring Grove, PA 17362  
UNITED STATES OF AMERICA

### Agent

DEETH WILLIAMS WALL LLP  
150 YORK STREET, SUITE 400, TORONTO,  
ONTARIO, M5H3S5

## TRADEMARK DETAILS

# OPTIPRIME REFLECTIONS

### Trademark Type

Standard Characters

### Goods

#### Class 16

Paper, namely, face stock paper designed for high-end pressure sensitive label applications

### Claims

Priority Filing Date: January 05, 2021, Country or Office: UNITED STATES OF AMERICA,  
Application No: 90/448,113 in association with the same kind of goods

**Application Number** 2,105,312  
**Language of Application** English

**Filing Date** 2021-05-06

## **APPLICANT AND AGENT DETAILS**

### **Applicant**

Medline Industries, LP  
Three Lakes Drive  
Northfield, IL 60093  
UNITED STATES OF AMERICA

### **Agent**

DEETH WILLIAMS WALL LLP  
150 YORK STREET, SUITE 400, TORONTO,  
ONTARIO, M5H3S5

## **TRADEMARK DETAILS**

# **OPTICELL**

### **Trademark Type**

Standard Characters

### **Goods**

#### **Class 05**

Wound dressings.

**Application Number** 2,105,313  
**Language of Application** English

**Filing Date** 2021-05-06

## APPLICANT AND AGENT DETAILS

### Applicant

Pixelle Specialty Solutions LLC  
228 South Main Street  
Spring Grove, PA 17362  
UNITED STATES OF AMERICA

### Agent

DEETH WILLIAMS WALL LLP  
150 YORK STREET, SUITE 400, TORONTO,  
ONTARIO, M5H3S5

## TRADEMARK DETAILS

# GLAZESIL

### Trademark Type

Standard Characters

### Goods

#### Class 16

Paper, namely, uncoated machine-glazed paper for silicone coating used in hygiene applications

### Claims

Priority Filing Date: December 22, 2020, Country or Office: UNITED STATES OF AMERICA,  
Application No: 90/402,913 in association with the same kind of goods

**Application Number** 2,105,348  
**Language of Application** English

**Filing Date** 2021-05-06

## APPLICANT AND AGENT DETAILS

### Applicant

Onyx Office Share Inc.  
Suite 1215, 650 West Georgia Street  
Vancouver  
BRITISH COLUMBIA  
V6B4N9

### Agent

OYEN WIGGS GREEN & MUTALA LLP  
480-THE STATION, 601 WEST CORDOVA  
STREET, VANCOUVER, BRITISH  
COLUMBIA, V6B1G1

## TRADEMARK DETAILS

**Trademark Type**

Design

**Visual Representation**



**Services**

**Class 45**

legal services

**Application Number** 2,105,362  
**Language of Application** English

**Filing Date** 2021-05-06

## APPLICANT AND AGENT DETAILS

### Applicant

Onyx Office Share Inc.  
Suite 1215, 650 West Georgia Street  
Vancouver  
BRITISH COLUMBIA  
V6B4N9

### Agent

OYEN WIGGS GREEN & MUTALA LLP  
480-THE STATION, 601 WEST CORDOVA  
STREET, VANCOUVER, BRITISH  
COLUMBIA, V6B1G1

## TRADEMARK DETAILS

### Trademark Type

Design

### Visual Representation



### Services

Class 45

legal services

**Application Number** 2,105,396  
**Language of Application** English

**Filing Date** 2021-05-06

## APPLICANT DETAILS

### Applicant

Xin Xie  
Yaotang Villagers Group, Shimu Village  
Xiangshui Township, Yuhu District  
Xiangtan, Hu'nan, 411100  
CHINA

## TRADEMARK DETAILS

# SIWVL

### Trademark Type

Standard Characters

### Goods

#### Class 28

Dominoes; Bath toys; Caps for toy pistols; Cat toys; Checkers pieces; Children's multiple activity toys; Construction toys; Board games; Flying discs; Dog toys; Drawing toys; Educational toys; Electronic action toys; Inflatable swimming floats; Inflatable pools for recreational use; Inflatable toys; Jigsaw puzzles; Mechanical toys; Parlor games; Pet toys



**Application Number** 2,105,408  
**Language of Application** English

**Filing Date** 2021-05-07

## APPLICANT AND AGENT DETAILS

### Applicant

Luojia Cultural Development (Huizhou) Co., Ltd.  
Room 02,2nd Floor,Unit 2  
Bldg B,Tianze Mingju  
No.22 Xinli Rd  
Huizhou, 516001  
CHINA

### Agent

MILTONS IP/P.I.  
#200-15 Fitzgerald Road, Ottawa, ONTARIO,  
K2H9G1

## TRADEMARK DETAILS

# Poleview

### Trademark Type

Standard Characters

### Goods

#### Class 10

facial massagers; vibrators massagers; feeding bottle teats; ear plugs for noise reduction; sex dolls; Sex toys; personal vibrators; hearing aids for the deaf; heating cushions for medical purpose; Orthopaedic belts; Condoms; respiratory masks for medical purposes; protective gloves for medical use; air mattresses for medical purposes; air pillows for medical purposes.

**Application Number** 2,105,413  
**Language of Application** English

**Filing Date** 2021-05-07

## APPLICANT DETAILS

### Applicant

Shenzhen Xiaojiangnan Technology Co., Ltd.  
WORLD A24-1A/A24-8B, No.1 ,Yabao Rd  
Nankeng Community, Bantian St, Longgang  
Shenzhen, 518116  
CHINA

## TRADEMARK DETAILS

# Racingreat

### Trademark Type

Standard Characters

### Goods

#### Class 20

living room furniture; Chairs; chaise lounges; Tables; portable desks; drafting tables; Divans; cabinet work; standing desks; folding seats; folding tables; Sofas; Settees; deck chairs; display cases.

**Application Number** 2,105,415  
**Language of Application** English

**Filing Date** 2021-05-07

## APPLICANT AND AGENT DETAILS

### Applicant

Bunzl IP Holdings, LLC  
One CityPlace Drive  
Suite 200  
Creve Coeur, MO 63141  
UNITED STATES OF AMERICA

### Agent

GOWLING WLG (CANADA) LLP  
SUITE 2600, 160 ELGIN STREET, OTTAWA,  
ONTARIO, K1P1C3

## TRADEMARK DETAILS

### Trademark Type

Design

### Visual Representation



### Goods

#### Class 16

(1) paper napkins; paper towels; facial tissue; food wrapping plastic film; plastic food storage bags for household use

#### Class 20

(2) plastic containers and covers for the food industry

#### Class 21

(3) paper cups; drinking straws of paper

### Claims

Priority Filing Date: December 17, 2020, Country or Office: UNITED STATES OF AMERICA,  
Application No: 90/389,309 in association with the same kind of goods

**Application Number** 2,105,416  
**Language of Application** English

**Filing Date** 2021-05-07

## APPLICANT AND AGENT DETAILS

### Applicant

Bunzl IP Holdings, LLC  
One CityPlace Drive  
Suite 200  
Creve Coeur, MO 63141  
UNITED STATES OF AMERICA

### Agent

GOWLING WLG (CANADA) LLP  
SUITE 2600, 160 ELGIN STREET, OTTAWA,  
ONTARIO, K1P1C3

## TRADEMARK DETAILS

# PREMIER ESSENTIAL

### Trademark Type

Standard Characters

### Goods

#### Class 16

(1) paper napkins; paper towels; facial tissue; food wrapping plastic film; plastic food storage bags for household use

#### Class 20

(2) plastic containers and covers for the food industry

#### Class 21

(3) paper cups; drinking straws of paper

### Claims

Priority Filing Date: December 15, 2020, Country or Office: UNITED STATES OF AMERICA, Application No: 90/382,777 in association with the same kind of goods

**Application Number** 2,105,423  
**Language of Application** English

**Filing Date** 2021-05-07

## **APPLICANT DETAILS**

### **Applicant**

Thaifoon Ltd.  
120, Dundas Street,  
London  
ONTARIO  
N6A1G1

## **TRADEMARK DETAILS**

# **Thaifoon**

### **Trademark Type**

Standard Characters

### **Services**

#### **Class 43**

(1) bar and restaurant services; cafe-restaurants; mobile restaurant services; restaurant services; take-out restaurant services  
(2) dine-in restaurant services

**Application Number** 2,105,459  
**Language of Application** English

**Filing Date** 2021-05-07

## APPLICANT AND AGENT DETAILS

### Applicant

Plews, Inc.  
1550 Franklin Grove Road  
Dixon, IL 61021  
UNITED STATES OF AMERICA

### Agent

DEETH WILLIAMS WALL LLP  
150 YORK STREET, SUITE 400, TORONTO,  
ONTARIO, M5H3S5

## TRADEMARK DETAILS

# RUGGED WRAP

### Trademark Type

Standard Characters

### Goods

#### Class 12

Automotive power steering hoses

### Claims

Priority Filing Date: May 06, 2021, Country or Office: UNITED STATES OF AMERICA, Application No: 90/694,419 in association with the same kind of goods

**Application Number** 2,105,494  
**Language of Application** English

**Filing Date** 2021-05-07

## APPLICANT AND AGENT DETAILS

### Applicant

Davines S.p.A.  
Via Don Angelo Calzolari 55/A  
Parma, 43126  
ITALY

### Agent

DRAKE MARKS ASSOCIATES  
777 Hornby Street, Suite 600, Vancouver,  
BRITISH COLUMBIA, V6Z1S4

## TRADEMARK DETAILS

# NATURALTECH ELEVATING CLAY SUPERCLEANSER

### Trademark Type

Standard Characters

### Goods

### Class 03

Cosmetic preparations for the hair and scalp; scalp care preparations; shampoos



**Application Number** 2,105,495  
**Language of Application** English

**Filing Date** 2021-05-07

## APPLICANT AND AGENT DETAILS

### Applicant

Davines S.p.A.  
Via Don Angelo Calzolari 55/A  
Parma, 43126  
ITALY

### Agent

DRAKE MARKS ASSOCIATES  
777 Hornby Street, Suite 600, Vancouver,  
BRITISH COLUMBIA, V6Z1S4

## TRADEMARK DETAILS

# NATURALTECH ELEVATING SCALP RECOVERY TREATMENT

### Trademark Type

Standard Characters

### Goods

#### Class 03

Cosmetic preparations for the hair and scalp; scalp care preparations

**Application Number** 2,105,496  
**Language of Application** English

**Filing Date** 2021-05-07

## APPLICANT AND AGENT DETAILS

### Applicant

Davines S.p.A.  
Via Don Angelo Calzolari 55/A  
Parma, 43126  
ITALY

### Agent

DRAKE MARKS ASSOCIATES  
777 Hornby Street, Suite 600, Vancouver,  
BRITISH COLUMBIA, V6Z1S4

## TRADEMARK DETAILS

# NATURALTECH ELEVATING MASSAGE OIL

### Trademark Type

Standard Characters

### Goods

#### Class 03

Scalp massage oils; hand massage oils

**Application Number** 2,105,497  
**Language of Application** English

**Filing Date** 2021-05-07

## APPLICANT AND AGENT DETAILS

### Applicant

Davines S.p.A.  
Via Don Angelo Calzolari 55/A  
Parma, 43126  
ITALY

### Agent

DRAKE MARKS ASSOCIATES  
777 Hornby Street, Suite 600, Vancouver,  
BRITISH COLUMBIA, V6Z1S4

## TRADEMARK DETAILS

# NATURALTECH REBALANCING CLEANSING TREATMENT

### Trademark Type

Standard Characters

### Goods

#### Class 03

Cosmetic preparations for the hair and scalp; scalp care preparations; shampoos

**Application Number** 2,105,498  
**Language of Application** English

**Filing Date** 2021-05-07

## APPLICANT AND AGENT DETAILS

### Applicant

Community 66, LLC  
723 Washington Street  
Hoboken, NJ 07030  
UNITED STATES OF AMERICA

### Agent

JENSEN IP  
234 - 38 Auriga Drive, Ottawa, ONTARIO,  
K2E8A5

## TRADEMARK DETAILS

# COMMUNITY 66

### Trademark Type

Standard Characters

### Goods

#### Class 03

Cosmetics;

**Application Number** 2,105,499  
**Language of Application** English

**Filing Date** 2021-05-07

## APPLICANT AND AGENT DETAILS

### Applicant

Community 66, LLC  
723 Washington Street  
Hoboken, NJ 07030  
UNITED STATES OF AMERICA

### Agent

JENSEN IP  
234 - 38 Auriga Drive, Ottawa, ONTARIO,  
K2E8A5

## TRADEMARK DETAILS

# COMMUNITY SIXTY SIX

### Trademark Type

Standard Characters

### Goods

#### Class 03

Cosmetics;

### Claims

Priority Filing Date: March 24, 2021, Country or Office: UNITED STATES OF AMERICA,  
Application No: 90598979 in association with the same kind of goods

**Application Number** 2,105,500  
**Language of Application** English

**Filing Date** 2021-05-07

## APPLICANT AND AGENT DETAILS

### Applicant

Community 66, LLC  
723 Washington Street  
Hoboken, NJ 07030  
UNITED STATES OF AMERICA

### Agent

JENSEN IP  
234 - 38 Auriga Drive, Ottawa, ONTARIO,  
K2E8A5

## TRADEMARK DETAILS

# C66

### Trademark Type

Standard Characters

### Goods

#### Class 03

Cosmetics;

### Claims

Priority Filing Date: March 24, 2021, Country or Office: UNITED STATES OF AMERICA,  
Application No: 90599051 in association with the same kind of goods

**Application Number** 2,105,548  
**Language of Application** English

**Filing Date** 2021-05-07

## APPLICANT AND AGENT DETAILS

### Applicant

Peter RANIERI  
420 Sumner Ave  
Oakville  
ONTARIO  
L6J1S9

### Agent

KEVIN E. HOLBECHE  
(c/o Holbeche Law), 201-1300 Cornwall Rd,  
Oakville, ONTARIO, L6J7W5

## TRADEMARK DETAILS

# HYDRA VODKA SERIES

### Trademark Type

Standard Characters

### Goods

#### Class 33

- (1) vodka cocktails
- (2) vodka cocktails, namely, vodka soda beverages;

**Application Number** 2,105,567  
**Language of Application** English

**Filing Date** 2021-05-07

## APPLICANT AND AGENT DETAILS

### Applicant

2 B BOUNTIFUL, INC.  
85 West Street  
Walpole, MA 02081  
UNITED STATES OF AMERICA

### Agent

ZAK MUSCOVITCH  
(Muscovitch Law Professional Corp.), 534  
Lawrence Avenue West, Unit 201, Toronto,  
ONTARIO, M6A1A2

## TRADEMARK DETAILS

# BYE SUGAH

### Trademark Type

Standard Characters

### Goods

#### Class 30

Sugar-free consumables, namely, candy, hard candy, soft candy, gummy candies, lollipops

### Claims

Priority Filing Date: April 29, 2021, Country or Office: UNITED STATES OF AMERICA, Application No: 90681900 in association with the same kind of goods



**Application Number** 2,105,596  
**Language of Application** English

**Filing Date** 2021-05-07

## APPLICANT AND AGENT DETAILS

### Applicant

Globally Local Ltd.  
505 Consortium Court  
London  
ONTARIO  
N6E2S8

### Agent

PETER DILLON  
(SISKINDS LLP), 275 Dundas Street, Unit 1,  
London, ONTARIO, N6B3L1

## TRADEMARK DETAILS

# WINGALINGS

### Trademark Type

Standard Characters

### Goods

#### Class 29

Plant-based meat substitute, namely vegan chicken wings

**Application Number** 2,105,599  
**Language of Application** English

**Filing Date** 2021-05-07

## APPLICANT AND AGENT DETAILS

### Applicant

Globally Local Ltd.  
505 Consortium Court  
London  
ONTARIO  
N6E2S8

### Agent

PETER DILLON  
(SISKINDS LLP), 275 Dundas Street, Unit 1,  
London, ONTARIO, N6B3L1

## TRADEMARK DETAILS

# PRETENDERS

### Trademark Type

Standard Characters

### Goods

#### Class 29

Plant-based meat substitute, namely vegan breaded chicken

**Application Number** 2,105,603  
**Language of Application** English

**Filing Date** 2021-05-07

## APPLICANT AND AGENT DETAILS

### Applicant

Montcrest Asset Management Inc.  
400-1131a Leslie St.  
Toronto  
ONTARIO  
M3C3L8

### Agent

BERESKIN & PARR LLP/S.E.N.C.R.L., S.R.L.  
SCOTIA PLAZA, 40 KING STREET WEST,  
40th FLOOR, TORONTO, ONTARIO, M5H3Y2

## TRADEMARK DETAILS

# NYX

### Trademark Type

Standard Characters

### Services

#### Class 36

appraisal of real estate; arranging finance for construction projects; arranging of leases and rental agreements for real estate; arranging of loans; assessment and management of real estate; building leasing; building management; capital investment; capital investment consulting services; collection of rents; credit and loan services; credit inquiry and consultancy; debt collection; equity investment in international companies; evaluation of real property; financial analysis; financial analysis and research services; financial asset management; financial investment counselling; financial investments in the field of securities; financial management; financial placement of private equity funds for others; financial planning and investment advisory services; financial valuations; fund investments; fundraising services; investment agencies in the field of securities; investment banking; investment management; investment of funds; land leasing; leasing of real estate; management of a capital investment fund; management of apartments; management of office buildings; management of portfolios comprising securities; mortgage services; private equity fund investment services; property management; real estate agency services; real estate appraisal and valuation; real estate brokerage; real estate consultancy; real estate investment services; real estate management services; rental of real estate; venture capital financing; venture capital fund management

**Application Number** 2,105,648  
**Language of Application** English

**Filing Date** 2021-05-08

## APPLICANT AND AGENT DETAILS

### Applicant

Chunyu Liu  
No. 11, Jingye Road, East District  
Jinjiang City Economic Development Zone  
(Yinglin Park)  
Quanzhou City, Fujian Province,  
CHINA

### Agent

XIN XU  
(Fang An Law PC), Suite 300 & 306, 5500  
North Service Rd., Burlington, ONTARIO,  
L7L6W6

## TRADEMARK DETAILS

**origiwish**

### Trademark Type

Standard Characters

### Goods

#### Class 25

Overalls; Jumpers; Trousers; Jackets; knit tops; knit jackets; knit shirts; knit skirts; Coats; Skirts; tee-shirts; Pants; Knickers; sports singlets; boxer shorts; Tights; Corselets; Waistcoats; cyclists' clothing; bathing caps; bathing trunks; bathing suits; raincoats; sports shoes; Slippers; Hats; Scarves; ski gloves; baby clothing; casual clothing; children's clothing; coats for men and women

**Application Number** 2,105,650  
**Language of Application** English

**Filing Date** 2021-05-08

## APPLICANT DETAILS

### Applicant

Shenzhen Hailu Technology Co., Ltd.  
308, Huayang Building, 41 Huaqiao Xincun  
Minqiang Community, Minzhi Subdistrict  
Longhua District  
Shenzhen, 518000  
CHINA

## TRADEMARK DETAILS

# binbok

### Trademark Type

Standard Characters

### Goods

#### Class 28

hand-held video game apparatus; gaming machines; video game machines; hand-held games with liquid crystal displays; controllers for game consoles; joysticks for video games; protective films adapted for screens for portable games; exercise benches; toy models; radio-controlled toys; toy robots; Tennis rackets; stationary exercise bicycles; exercise balls; Christmas trees of synthetic material; rods for fishing; chess games; chess game sets; plush toys; treadmills; Rowing machines; elbow guards for athletic use; protective films adapted for portable games with liquid crystal displays; handheld game consoles; stand alone video game machines; electronic hand-held game units

**Application Number** 2,105,651  
**Language of Application** English

**Filing Date** 2021-05-08

## **APPLICANT DETAILS**

### **Applicant**

Foshan Yuning Trading Co., Ltd.  
Room 1436-2, Wantong International  
No. 51 Fenjiang South Road, Chancheng  
District  
Foshan, Guangdong, 528000  
CHINA

## **TRADEMARK DETAILS**

# **Dinosaur**

### **Trademark Type**

Standard Characters

### **Goods**

#### **Class 27**

floor carpets; floor rugs; Floor mats

**Application Number** 2,105,652  
**Language of Application** English

**Filing Date** 2021-05-08

## APPLICANT DETAILS

### Applicant

Shen Zhen Shi Jiao Bi Mao Yi Company  
Limited  
A146, 4th Floor, Guoanju Decorative Building  
Materials Market  
No. 6021 Longxiang Avenue, Longcheng  
Subdistrict, Longgang District  
Shenzhen, Guangdong, 518000  
CHINA

## TRADEMARK DETAILS

# Seteol

### Trademark Type

Standard Characters

### Goods

#### Class 27

floor carpets; floor rugs; Floor mats

**Application Number** 2,105,697  
**Language of Application** English

**Filing Date** 2021-05-10

## APPLICANT AND AGENT DETAILS

### Applicant

Fujian Puchuang Information Technology Co.,  
Ltd.  
Room 1005, 10th Floor, Block A, Jiuce Building  
Haixi High-tech Industrial Park, Fuzhou High-  
tech Zone  
Fujian Province, 350100  
CHINA

### Agent

MILTONS IP/P.I.  
#200-15 Fitzgerald Road, Ottawa, ONTARIO,  
K2H9G1

## TRADEMARK DETAILS

# putuo decor

### Trademark Type

Standard Characters

### Goods

#### Class 06

(1) identity plates of metal; decorative metal boxes; metal clothes hooks; license plates of metal; Metal name plates; Metal pallets; Metal storage tanks; Metal strong boxes; metal barrels; tin cans; non-luminous and non-mechanical road signs of metal; non-luminous traffic signs of metal; Numberplates of metal; Placards of metal; Statues of common metal; Storage pallets of metal; Tins of metal; Works of art of common metal; Wrought iron decorative artwork

#### Class 20

(2) Bathroom furniture; Bedroom furniture; dining room furniture; metal cabinets; mirror frames; mirrors; plastic clothes hooks; wooden clothes hooks; wooden pallets; Office furniture; Outdoor furniture; Picture frames; Pillows; signboards of wood or plastics; tables; upright signboards of wood or plastics; wood carvings; wax busts; statues of plaster



**Application Number** 2,105,710  
**Language of Application** English

**Filing Date** 2021-05-10

## APPLICANT AND AGENT DETAILS

### Applicant

Tiantai Gaoqiao Automobile Articles Co., Ltd.  
No.97, Leimakeng Village, Jietou Town, Tiantai  
County  
Taizhou, Zhejiang, 317200  
CHINA

### Agent

MILTONS IP/P.I.  
#200-15 Fitzgerald Road, Ottawa, ONTARIO,  
K2H9G1

## TRADEMARK DETAILS

# LUCKYMAN CLUB

### Trademark Type

Standard Characters

### Goods

#### Class 12

automotive interior trim; car seat covers; automobile seat cushions; luggage nets for vehicles;  
vehicle windshield sunshades; covers for vehicle steering wheels; head-rests for vehicle seats;  
vehicle luggage carriers

**Application Number** 2,105,713  
**Language of Application** English

**Filing Date** 2021-05-10

## APPLICANT AND AGENT DETAILS

### Applicant

Sunday's Spirits Holding Limited  
1200 South Garfield St  
Denver, CO 80210  
UNITED STATES OF AMERICA

### Agent

THEO YATES  
(Yates IP), 17 Bellwood Avenue, Ottawa,  
ONTARIO, K1S1S6

## TRADEMARK DETAILS

# SUNDAY'S ARE BETTER THAN OTHERS

### Trademark Type

Standard Characters

### Goods

#### Class 33

Alcoholic cocktail mixes; Alcoholic fruit extracts; Brandy; Hard cider; Prepared alcoholic cocktails; Rice alcohol; Sake; Spirits, namely Whisky; liqueurs; Wine

**Application Number** 2,105,730  
**Language of Application** English

**Filing Date** 2021-05-10

## APPLICANT AND AGENT DETAILS

### Applicant

Wenling Eva networking technology Co.,Ltd  
No.327 gaoyan,shitang  
wenling zhejiang, 317513  
CHINA

### Agent

WITMART INC.  
34 King Street East, Suite 500, Toronto,  
ONTARIO, M5C2X8

## TRADEMARK DETAILS

# WKUP

### Trademark Type

Standard Characters

### Goods

#### Class 17

plastic junctions for flexible pipes; plastic junctions for pipes; pipe couplings of rubber; o-rings; pipe gaskets; rubber washers; pipe jackets; pipe joint sealants; pipe joint tape; garden hoses

**Application Number** 2,105,737  
**Language of Application** English

**Filing Date** 2021-05-10

## APPLICANT AND AGENT DETAILS

### Applicant

GUANGZHOU WEHOMATE HOUSEWARE  
CO., LTD.  
C8, 13-14 DONG, NO.58,  
ZHAOCUNBEIWAI YUE, LIWAN DISTRICT,  
GUANGZHOU, GUANGDONG, 510370  
CHINA

### Agent

AVENTUM IP LAW LLP  
Suite 104, Tower A, 555 Legget Drive, Ottawa,  
ONTARIO, K2K2X3

## TRADEMARK DETAILS

# webake

### Trademark Type

Standard Characters

### Goods

#### Class 21

Cake moulds; baking mats; food storage containers; enamelled glass; potholders; drink coasters; beverage glassware; china dinnerware; soap holders; ice cube moulds.

**Application Number** 2,105,801  
**Language of Application** English

**Filing Date** 2021-05-10

## APPLICANT AND AGENT DETAILS

### Applicant

Grand Design RV, LLC  
11333 County Road 2  
Middlebury, IN 46540  
UNITED STATES OF AMERICA

### Agent

CPST INTELLECTUAL PROPERTY INC.  
130 Queens Quay East, East Tower, Suite  
809, Toronto, ONTARIO, M5A0P6

## TRADEMARK DETAILS

# GRAND COACH

### Trademark Type

Standard Characters

### Goods

#### Class 12

Recreational vehicles, namely, motor homes.

### Claims

Priority Filing Date: November 20, 2020, Country or Office: UNITED STATES OF AMERICA,  
Application No: 90/333,530 in association with the same kind of goods

**Application Number** 2,105,819  
**Language of Application** English

**Filing Date** 2021-05-10

## **APPLICANT AND AGENT DETAILS**

### **Applicant**

Colgate-Palmolive Canada Inc.  
Two Morneau Sobeco Centre  
6th Floor, 895 Don Mills Road  
Toronto  
ONTARIO  
M3C1W3

### **Agent**

SMART & BIGGAR LP  
1100-150 York street, TORONTO, ONTARIO,  
M5H3S5

## **TRADEMARK DETAILS**

# **DREAMTUBE**

### **Trademark Type**

Standard Characters

### **Goods**

#### **Class 03**

Non-medicated toothpaste

**Application Number** 2,105,879  
**Language of Application** English

**Filing Date** 2021-05-10

## **APPLICANT DETAILS**

### **Applicant**

Mao Bai  
5111 Williams Rd  
Richmond  
BRITISH COLUMBIA  
V7E1K2

## **TRADEMARK DETAILS**

# **BRAW**

### **Trademark Type**

Standard Characters

### **Foreign Character Translation**

The translation provided by the applicant of the word BRAW is fine, excellent, and pleasant.

### **Goods**

#### **Class 20**

bathroom furniture; bedroom furniture; bedroom furniture parts; bumper guards for furniture; camping furniture; chairs; computer furniture; computer furniture parts; cushions; dining room furniture; dining room furniture parts; dinner wagons being furniture; doors for furniture

**Application Number** 2,105,958  
**Language of Application** English

**Filing Date** 2021-05-11

## **APPLICANT DETAILS**

### **Applicant**

Shenzhen Ya'an International Trade Co., Ltd.  
1210,Block A,Jiahe Huaqiang Bldg. Shennan  
Middle Rd.,Huaqiang Bei Street Futian  
Shenzhen,  
CHINA

## **TRADEMARK DETAILS**

### **Trademark Type**

Design

### **Visual Representation**



### **Goods**

#### **Class 25**

Scarves; Gloves; Socks; Hats; skull caps; Underclothing; Nightshirts; cap visors; socks and stockings; ski gloves; Headbands;



**Application Number** 2,105,959  
**Language of Application** English

**Filing Date** 2021-05-11

## APPLICANT AND AGENT DETAILS

### Applicant

UTILLIFE TRADING LTD. LTD.  
Apartment 113 20 TECHNOLOGY Drive  
Saint John  
NEW BRUNSWICK  
E2K0J4

### Agent

MILTONS IP/P.I.  
#200-15 Fitzgerald Road, Ottawa, ONTARIO,  
K2H9G1

## TRADEMARK DETAILS

# maglava

### Trademark Type

Standard Characters

### Goods

#### Class 03

(1) perfumes

#### Class 04

(2) scented candles

#### Class 21

(3) candle holders

**Application Number** 2,105,973  
**Language of Application** English

**Filing Date** 2021-05-11

## APPLICANT AND AGENT DETAILS

### Applicant

1594112 Alberta Ltd.  
174 Cranarch Close SE  
Calgary  
ALBERTA  
T3M0T9

### Agent

WILLIAM R. STEMPE  
(STEMPE & COMPANY), 1670, 734 - 7 Avenue  
SW, Calgary, ALBERTA, T2P3P8

## TRADEMARK DETAILS

# TOLIANO LIPS

### Trademark Type

Standard Characters

### Services

#### Class 44

injectable filler treatments for cosmetic purposes; cosmetic facial and body treatment services

**Application Number** 2,105,981  
**Language of Application** English

**Filing Date** 2021-05-11

## APPLICANT AND AGENT DETAILS

### Applicant

ShenZhenShi JiaYuan E-Commerce Co., Ltd  
330, Bld 28, YinTian Industrial Zone,  
YanTian, XiXiang Street, BaoAn District,  
Shenzhen City, Guangdong Province, 518102  
CHINA

### Agent

XIN XU  
(Fang An Law PC), Suite 300 & 306, 5500  
North Service Rd., Burlington, ONTARIO,  
L7L6W6

## TRADEMARK DETAILS

# TRONWIN

### Trademark Type

Standard Characters

### Goods

#### Class 09

Earphones and headphones; cabinets for loudspeakers; loudspeakers; audio- and video-receivers; smartwatches; wearable activity trackers; cases adapted for mobile phones; batteries for cell phones; electric power converters; USB chargers; converters for electric plugs; remote controls for televisions; microphones; smartglasses; emergency signal transmitters; video camera stands; selfie stick; cell phone holders

**Application Number** 2,105,999  
**Language of Application** English

**Filing Date** 2021-05-11

## APPLICANT AND AGENT DETAILS

### Applicant

Chrome Hearts LLC  
915 N. Mansfield  
Hollywood, CA 90038  
UNITED STATES OF AMERICA

### Agent

ROBIC  
630, boul. René-Lévesque Ouest, 20e étage,  
Montréal, QUEBEC, H3B1S6

## TRADEMARK DETAILS

### Trademark Type

Design

### Visual Representation

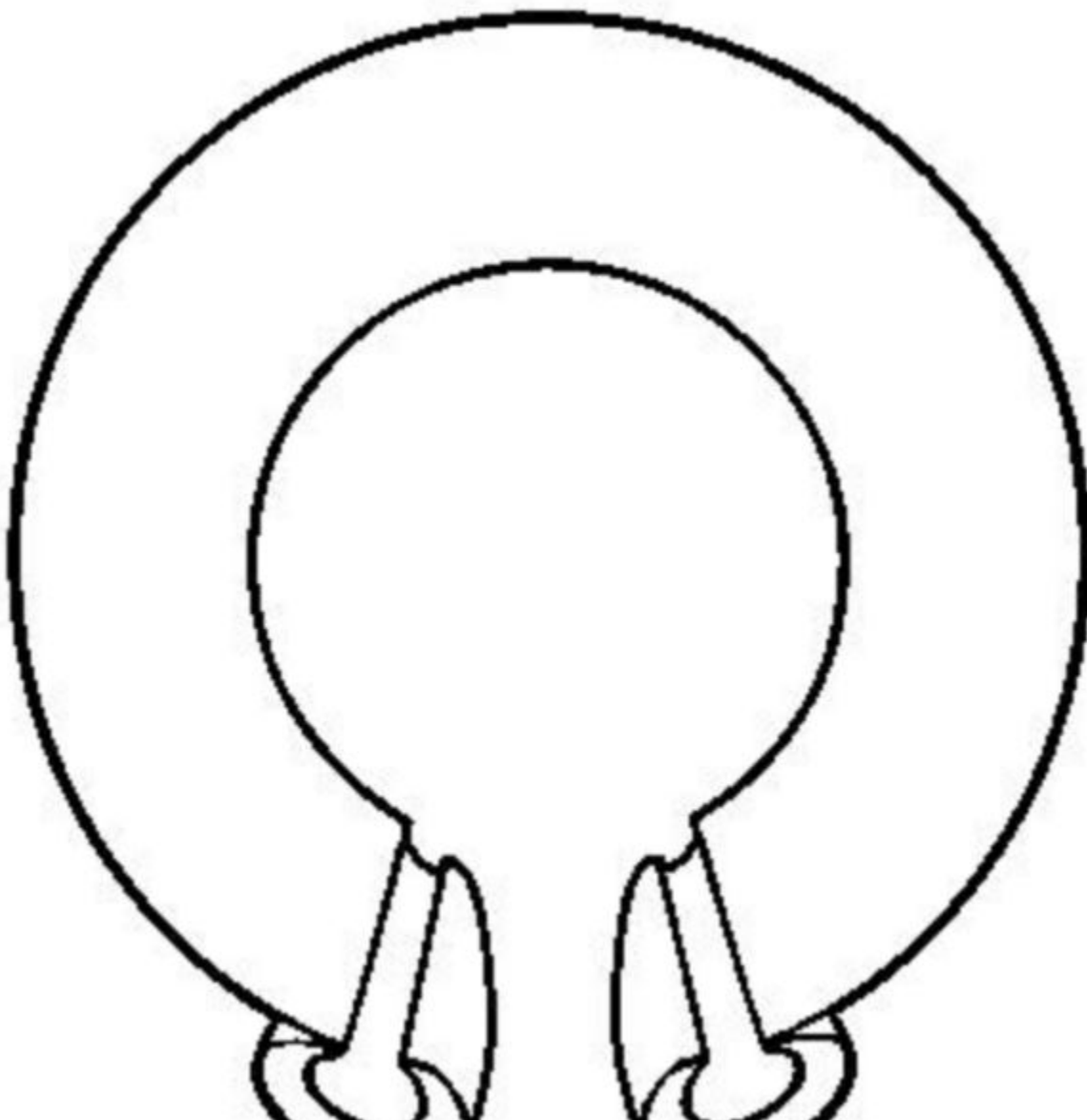

**Goods****Class 25**

Clothing, namely, pants, shirts, tee shirts, tank tops, sweatshirts, sweatpants, jeans, sweaters, jackets, coats, suits, dresses, vests, chaps, skirts, belts, swimwear, sleepwear, underwear, gloves, scarves, socks, headbands, hats, ties, knit face masks being headwear, lab coats, footwear, namely, Boots, Booties, Formal Shoes, Dress Shoes, Casual Shoes, High Heeled Shoes, Flats, Sneakers, Athletic Shoes, Slip-ons, Slippers, Sandals, Flip-Flops, Boat Shoes, Drivers, Oxfords, Loafers, Clogs, Mules, Platform shoes, Wedges, Rain Boots, All-Weather Boots, Moccasins.

**Application Number** 2,106,032  
**Language of Application** English

**Filing Date** 2021-05-11

## APPLICANT AND AGENT DETAILS

### Applicant

American Sports Licensing, LLC  
345 Court Street  
Coraopolis, PA 15108  
UNITED STATES OF AMERICA

### Agent

STIKEMAN ELLIOTT S.E.N.C.R.L., SRL/LLP  
(Departement IP Department), 1155 Boul.  
René-Lévesque Ouest, Bureau 4000, 41  
Étage, Montréal, QUEBEC, H3B3V2

## TRADEMARK DETAILS

# TEMPER

### Trademark Type

Standard Characters

### Goods

#### Class 12

Personal watercraft, namely, pedal boats;

### Claims

Priority Filing Date: November 13, 2020, Country or Office: UNITED STATES OF AMERICA,  
Application No: 90318843 in association with the same kind of goods

**Application Number** 2,106,037  
**Language of Application** English

**Filing Date** 2021-05-11

## APPLICANT AND AGENT DETAILS

### Applicant

New U Life Corporation  
2627 Pleasant Hill Road  
Pleasant Hill, CA 94523  
UNITED STATES OF AMERICA

### Agent

CPST INTELLECTUAL PROPERTY INC.  
130 Queens Quay East, East Tower, Suite  
809, Toronto, ONTARIO, M5A0P6

## TRADEMARK DETAILS

# Rose & Coal

### Trademark Type

Standard Characters

### Goods

#### Class 03

Body and beauty care cosmetics; Non-medicated skin care creams and lotions; Non-medicated skin care preparations.

**Application Number** 2,106,043  
**Language of Application** English

**Filing Date** 2021-05-11

## APPLICANT AND AGENT DETAILS

### Applicant

Traffic and Parking Control Co., Inc., a  
corporation of Wisconsin  
5100 West Brown Deer Road  
Brown Deer, WI 53223  
UNITED STATES OF AMERICA

### Agent

LAVERY, DE BILLY, LLP  
1 Place Ville Marie, Suite 4000, Montréal,  
QUEBEC, H3B4M4

## TRADEMARK DETAILS

# LEGENDVIZ

### Trademark Type

Standard Characters

### Goods

#### Class 09

Luminous signs

### Claims

Priority Filing Date: May 05, 2021, Country or Office: UNITED STATES OF AMERICA, Application No: 90/690,958 in association with the same kind of goods



**Application Number** 2,106,054  
**Language of Application** English

**Filing Date** 2021-05-11

## APPLICANT AND AGENT DETAILS

### Applicant

Colgate-Palmolive Canada Inc.  
Two Morneau Sobeco Centre, 6th Floor  
895 Don Mills Road  
Toronto  
ONTARIO  
M3C1W3

### Agent

SMART & BIGGAR LP  
1100-150 York street, TORONTO, ONTARIO,  
M5H3S5

## TRADEMARK DETAILS

### Trademark Type

Design

### Visual Representation





**Goods**

**Class 03**

Non-medicated toothpaste

**Application Number** 2,106,061  
**Language of Application** English

**Filing Date** 2021-05-11

## APPLICANT AND AGENT DETAILS

### Applicant

Nachurs Alpine Solutions, LLC  
421 Leader St  
Marion, OH 43302-2296  
UNITED STATES OF AMERICA

### Agent

RIDOUT & MAYBEE LLP  
250 University Avenue, 5th Floor, Toronto,  
ONTARIO, M5H3E5

## TRADEMARK DETAILS

# FORTITUDE SR

### Trademark Type

Standard Characters

### Goods

#### Class 01

Adjuvants for use with agricultural chemicals; Chemicals for use in agriculture, horticulture and forestry except fungicides, herbicides, insecticides and parasiticides

**Application Number** 2,106,067  
**Language of Application** English

**Filing Date** 2021-05-11

## APPLICANT AND AGENT DETAILS

### Applicant

Lightly Toasted, LLC  
143 W 29th Street  
New York, NY 10001  
UNITED STATES OF AMERICA

### Agent

COASTAL TRADEMARK SERVICES LIMITED  
301-543 Granville Street, Vancouver, BRITISH  
COLUMBIA, V6C1X8

## TRADEMARK DETAILS

# MERRY DISSMAS

### Trademark Type

Standard Characters

### Goods

Class 28

Card game

Application Number 2,106,153  
Language of Application English

Filing Date 2021-05-11

## APPLICANT AND AGENT DETAILS

### Applicant

PLB International inc.  
1361 Rue Graham-Bell  
Boucherville  
QUEBEC  
J4B6A1

### Agent

NATHALY J. VERMETTE  
(DS AVOCATS), 1080 Côte du Beaver Hall,  
Bureau 2100, Montréal, QUEBEC, H2Z1S8

## TRADEMARK DETAILS

Trademark Type

Design

Visual Representation

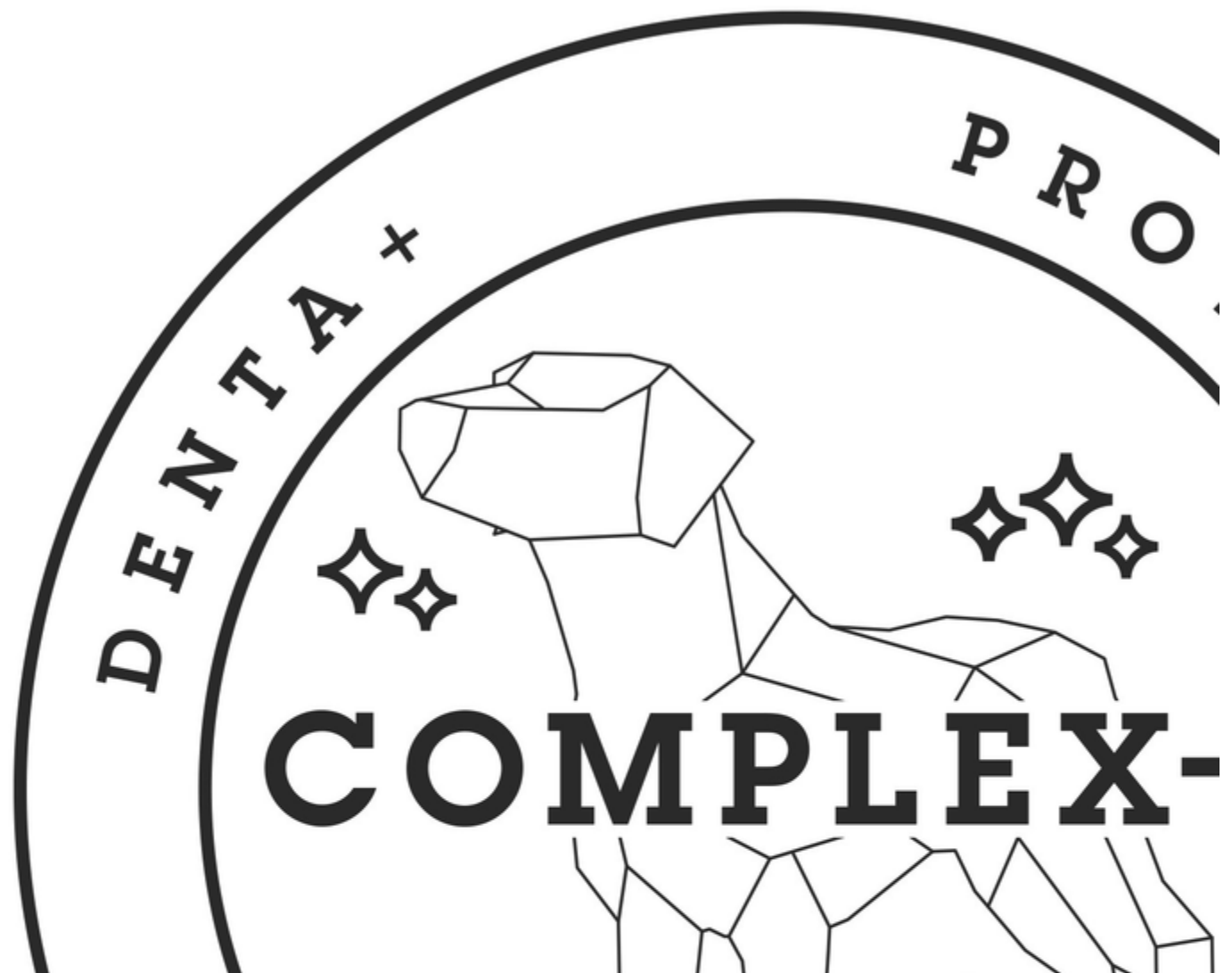



**Goods**

**Class 31**

Cat food; cat litter; dog food; litter for domestic animals; pet food

**Application Number** 2,106,161  
**Language of Application** English

**Filing Date** 2021-05-11

## APPLICANT AND AGENT DETAILS

### Applicant

Shenzhen Ta Cheng Industrial Co., Ltd  
No.3409 jinzhonghuan international business  
Jintian Road  
Futian District  
shenzhen, 518000  
CHINA

### Agent

MILTONS IP/P.I.  
#200-15 Fitzgerald Road, Ottawa, ONTARIO,  
K2H9G1

## TRADEMARK DETAILS

# Yabaco

### Trademark Type

Standard Characters

### Goods

#### Class 03

beauty masks; dentifrices; bath cream; dish detergents; facial cleansers; hair rinses; perfumes; false nails; false eyelashes; aromatic essential oils; cotton sticks for cosmetic purposes.

Application Number 2,106,169  
Language of Application English

Filing Date 2021-05-11

## APPLICANT DETAILS

Applicant  
AMZEY INC  
14247 E. DON JULIAN RD  
CITY OF INDUSTRY, CA 91746  
UNITED STATES OF AMERICA

## TRADEMARK DETAILS

Trademark Type  
Design

Visual Representation



Goods



**Class 21**

(1) insect traps; mousetraps; abrasive sponges for scrubbing the skin; scouring pads; dinnerware; litter trays for pets; lint brushes; pet bowls; drinking troughs for animals; pet cages; brushes for pets; pet feeding dishes; electrical toothbrushes; animal grooming gloves; feeding troughs; combs for animals; cages for household pets; trash cans; plastic rails for towels; plastic rings for towels; electric and non-electric lint removers; rings for birds; bird cages; bird feeders; diaper pails; cleaning cloth; pads of metal for cleaning; indoor aquaria; electric hair combs; water tanks for live fish; aquarium covers; dishwashing brushes; animal cages; nail brushes; food preserving jars of glass

**Class 31**

(2) pet food; aromatic sand litter for pets; edible chews for animals; animal starter feed; animal feed; packaged freeze-dried fishing bait; bran mash for animal consumption; dog food; digestible chewing bones for dogs; live fish for aquariums; live hatching eggs; live carp; live insects; live poultry; poultry feed; goldfish food; live shrimp; canned cat food; cat litter and litter for small animals; bird food; livestock feed; edible pet treats; live edible insects; unprocessed algae for human or animal consumption; food for aquarium fish; fodder; fish food; fish meal animal feed

**Application Number** 2,106,174  
**Language of Application** English

**Filing Date** 2021-05-11

## APPLICANT AND AGENT DETAILS

### Applicant

Xifeng Lian  
No. 10 Huating Kiln, Qianlian Village, Gaiwei  
Town  
Xianyou County, Fujian Province,  
CHINA

### Agent

XIN XU  
(Fang An Law PC), Suite 300 & 306, 5500  
North Service Rd., Burlington, ONTARIO,  
L7L6W6

## TRADEMARK DETAILS

# Seiyue

### Trademark Type

Standard Characters

### Goods

#### Class 09

3D spectacles; baby monitors; battery chargers for cell phones; capacitive styluses for touch screen devices; carrying cases for cell phones; carrying cases for digital music players; carrying cases adapted for computers; cell phone holders; protective cases for smartphones; protective cases for personal digital assistants; protective cases for MP3 players; stands adapted for mobile phones; stands adapted for tablet computers; cases adapted for computers; cell phones; computer software for running development programs and application programs in a common development environment; contact lenses; data cables; navigation apparatus for vehicles in the form of on-board computers; electrical cables; electrical plugs and sockets; protective films adapted for smartphone screens; protective films adapted for computer screens; galvanic cells; Headphones; keyboards for mobile phones; laptop computers; digital door locks; touch pads; tablet computers

**Application Number** 2,106,176  
**Language of Application** English

**Filing Date** 2021-05-12

## APPLICANT AND AGENT DETAILS

### Applicant

Xifeng Lian  
No. 10 Huating Kiln, Qianlian Village, Gaiwei  
Town  
Xianyou County, Fujian Province,  
CHINA

### Agent

XIN XU  
(Fang An Law PC), Suite 300 & 306, 5500  
North Service Rd., Burlington, ONTARIO,  
L7L6W6

## TRADEMARK DETAILS

# HIDLY

### Trademark Type

Standard Characters

### Goods

#### Class 10

apparatus for artificial respiration; artificial breasts; baby feeding dummies; breast pumps; compression vests; Condoms; contraceptive coils; contraceptive diaphragms; dental intra-oral cameras; electronic nerve stimulators for medical purposes; gloves for medical purposes; hearing aids; infrared thermometers for medical purposes; lasers for medical purposes; love dolls; masks for use by medical personnel; vibrators massagers; massage gloves; massage mitts; facial massagers; gum massagers; massage beds for medical purposes; medical and surgical catheters; medical and surgical laparoscopes; medical and surgical cutters for cutting human or animal tissue and organs; surgical instruments for use in orthopedic surgery; orthopaedic belts; orthopedic belts; Pessaries; scissors for surgery; sex toys; sterilization pouches for medical purposes; thermometers for medical purposes; toe separators for orthopaedic purposes; toe separators for orthopedic purposes; computed tomography [CT] scanners; oxygen masks for medical purposes; sanitary masks for dust isolation for medical purposes; sanitary masks for virus isolation purposes; surgical instruments; surgical masks; ultraviolet ray lamps for medical purposes

**Application Number** 2,106,179  
**Language of Application** English

**Filing Date** 2021-05-12

## APPLICANT AND AGENT DETAILS

### Applicant

Guangzhou Feidengxian Information  
Technology Co. , Ltd.  
guangzhoushi nanshaqu fengzedonglu  
106hao(zi bian 1 hao lou) X1301-E1242 511455  
guangdong guangzhou,  
CHINA

### Agent

XIN XU  
(Fang An Law PC), Suite 300 & 306, 5500  
North Service Rd., Burlington, ONTARIO,  
L7L6W6

## TRADEMARK DETAILS

# FRIDEKO HOME

### Trademark Type

Standard Characters

### Goods

#### Class 11

(1) light bulbs; electric bulbs; fairy lights for festive decoration; electric lamps; table lamps; lamp mantles; incandescent burners; lamp glasses; sockets for electric lights; lighting diffusers; lighting fixtures; Chandeliers; ceiling lights; filaments for electric lamps; lamp globes; string lights for festive decoration; safety lamps for underground use; chinese lanterns; Lanterns; miners' lamps; electric lights for christmas trees; lamp shades; lampshade holders; street lamps; aquarium lights; diving lights; led luminaires; germicidal lamps for purifying air; ultraviolet (UV) lamps for use in disinfecting surfaces; candle lanterns; stage spotlights

#### Class 20

(2) bedsteads of wood; Desks; office furniture; filing cabinets; Chairs; chaise lounges; Armchairs; Tables; Mattresses; Beds; furniture flower stands; metal camping furniture; metal vice benches being furniture; metal storage cabinets; furniture screens; Sofas; bed bases; dressing tables; massage tables; hairdressers' chairs; tea tables; bookcases

**Application Number** 2,106,199  
**Language of Application** English

**Filing Date** 2021-05-12

## APPLICANT DETAILS

### Applicant

Shenzhen Youli Technology Co., Ltd.  
C320, 4/F, Niulanqian Building  
Minzhi Avenue, Xinniu Community, Minzhi  
Street  
Longhua  
Shenzhen, 518131  
CHINA

## TRADEMARK DETAILS

**coylbod**

### Trademark Type

Standard Characters

### Goods

#### Class 02

(1) filled toner cartridges for laser printers; filled toner cartridges for inkjet printers; toner for copiers; printing ink; inks for printers and photocopiers; toner cartridges, filled, for printers and photocopiers; edible inks; filled edible ink cartridges for printers; toner for printers and photocopiers; ink cartridges, filled, for printers and photocopiers.

#### Class 03

(2) dish soap; windscreen cleaning liquids; ammonia used as a detergent; paint stripping preparations; cloths impregnated with a detergent for cleaning; cleaning preparations for leather; glass cleaner; laundry stain removers; all purpose cleaning preparations.

**Application Number** 2,106,207  
**Language of Application** English

**Filing Date** 2021-05-12

## APPLICANT DETAILS

### Applicant

Shenzhen Longood Intelligent Electric Co., Ltd  
1701, Building 1, Xinyilingyu R&D Center, No.  
30, Honglang North 2nd Road  
69 Unit, Xingdong Community, Xin'an Street,  
Bao'an District, Shenzhen, 518108,  
CHINA

## TRADEMARK DETAILS

### Trademark Type

Design

### Visual Representation



### Goods

#### Class 11

Incandescent light bulbs; germicidal lamps for purifying air; ultraviolet (UV) lamps for use in disinfecting surfaces; chemical light sticks; filters for air conditioners; light bulbs; lampshades; lampshade holders; led luminaires; led underwater boat guiding lights; safety lamps for underground use; lights for wall mounting; discharge lamps and their fittings; solar powered lamps; LED light bulbs; halogen lamps; halogen light bulbs; wall lamps; lighting fixtures; sconce lighting fixtures; LED landscape lights; infrared illuminators; infrared lighting fixtures; sockets for electric

lights; infrared lamps; accent lights for indoor use; electric discharge tubes for lighting; refrigerators; air conditioners; heat regenerators; water conditioning units; irrigation sprinklers; agricultural irrigation units; heating elements; agricultural irrigation equipment; water sterilizers; water softening units.

**Application Number** 2,106,243  
**Language of Application** English

**Filing Date** 2021-05-12

## APPLICANT AND AGENT DETAILS

### Applicant

King Juice Company, Inc.  
851 West Grange Avenue  
Milwaukee, WI 53221  
UNITED STATES OF AMERICA

### Agent

SMART & BIGGAR LP  
1100-150 York street, TORONTO, ONTARIO,  
M5H3S5

## TRADEMARK DETAILS

# OCEAN BLUE

### Trademark Type

Standard Characters

### Goods

#### Class 32

Non-alcoholic juices and fruit drinks; soft drinks; lemonade; limeade; none of the afore-mentioned goods containing cranberries or being cranberry flavoured

### Claims

Priority Filing Date: May 04, 2021, Country or Office: UNITED STATES OF AMERICA, Application No: 90/689,763 in association with the same kind of goods



**Application Number** 2,106,289  
**Language of Application** English

**Filing Date** 2021-05-12

## **APPLICANT AND AGENT DETAILS**

### **Applicant**

Main St. Group Inc.  
640 Main St  
Woodstock  
ONTARIO  
N4S8Y5

### **Agent**

DICKINSON WRIGHT LLP  
199 Bay Street, Suite 2200, P.O. Box 447,  
Commerce Court : Postal Station, Toronto,  
ONTARIO, M5L1G4

## **TRADEMARK DETAILS**

# **GLOBAL STORE WALKS**

### **Trademark Type**

Standard Characters

### **Services**

#### **Class 35**

Marketing strategies for others; advertising the goods and services of others;

**Application Number** 2,106,323  
**Language of Application** English

**Filing Date** 2021-05-12

## APPLICANT AND AGENT DETAILS

### Applicant

Jason O Campbell  
104 Larry Uteck Blvd  
Halifax  
NOVA SCOTIA  
B3M4Y2

### Agent

WITMART INC.  
34 King Street East, Suite 500, Toronto,  
ONTARIO, M5C2X8

## TRADEMARK DETAILS

**Trademark Type**

Design

**Visual Representation**



**Goods**

**Class 25**

(1) bathing suits; blouses; coats; dresses; gloves; hats; jackets; pants; scarves; shirts; shoes; shorts; skirts; socks; sweaters; underwear

(2) Hoodies [clothing]; leggings

**Application Number** 2,106,335  
**Language of Application** English

**Filing Date** 2021-05-12

## **APPLICANT AND AGENT DETAILS**

### **Applicant**

Main St. Group Inc.  
640 Main St  
Woodstock  
ONTARIO  
N4S8Y5

### **Agent**

DICKINSON WRIGHT LLP  
199 Bay Street, Suite 2200, P.O. Box 447,  
Commerce Court : Postal Station, Toronto,  
ONTARIO, M5L1G4

## **TRADEMARK DETAILS**

### **Trademark Type**

Design

### **Visual Representation**

GLOBAL  
ST  REWALKS

### **Services**

#### **Class 35**

Marketing strategies for others; advertising the goods and services of others.

**Application Number** 2,106,367  
**Language of Application** English

**Filing Date** 2021-05-12

## APPLICANT AND AGENT DETAILS

### Applicant

Peoples Trust Company  
1400 - 888 Dunsmuir Street  
Vancouver  
BRITISH COLUMBIA  
V6C3K4

### Agent

OYEN WIGGS GREEN & MUTALA LLP  
480-THE STATION, 601 WEST CORDOVA  
STREET, VANCOUVER, BRITISH  
COLUMBIA, V6B1G1

## TRADEMARK DETAILS

### Trademark Type

Design

### Visual Representation



LENDFAST

### Services

#### Class 36

arranging and provision of loans; financing of loans

**Application Number** 2,106,852  
**International Registration Number** 1591162  
**Language of Application** English

**Filing Date** 2021-04-13

## APPLICANT AND AGENT DETAILS

**Applicant**  
RWS GmbH  
Kronacher Straße 63  
90765 Fürth  
GERMANY

**Agent**  
SMART & BIGGAR LP  
SUITE 900, 55 METCALFE STREET, P.O.  
BOX 2999, STATION D, OTTAWA, ONTARIO,  
K1P5Y6

## TRADEMARK DETAILS

**Trademark Type**  
Design

**Visual Representation**



**Colour Claim**

Colour is claimed as a feature of the trademark. The colours blue and black are claimed as a feature of the trademark. In particular, the wording BLUE is blue. The wording PRIME and the design are black.

**Goods****Class 13**

Ammunition, especially primer charges; explosive primers

**Claims**

Priority Filing Date: January 15, 2021, Country or Office: GERMANY, Application No: 30 2021 100 596 in association with the same kind of goods

**Application Number** 2,106,900  
**International Registration Number** 1412517  
**Language of Application** French

**Filing Date** 2021-04-29

## APPLICANT AND AGENT DETAILS

### Applicant

GIVAUDAN SA  
Chemin de la Parfumerie 5  
CH-1214 Vernier  
SUISSE

### Agent

GOWLING WLG (CANADA) LLP  
SUITE 2600, 160 ELGIN STREET, OTTAWA,  
ONTARIO, K1P1C3

## TRADEMARK DETAILS

# DREAMSCENTZ

### Trademark Type

Standard Characters

### Goods

#### Class 01

(1) Chemicals for use in the manufacture of perfumes, cosmetics, soaps, detergents, deodorizers other than for personal use; chemical compounds for use in the manufacture of perfumes, cosmetics, soaps, detergents, deodorizers other than for personal use.

#### Class 03

(2) Perfume products, perfume bases, perfumes, essential oils for personal use, aromatic essential oils, essential oils for cosmetic use, essential oils for aromatherapy, beauty soaps, body care soaps, facial soaps, household detergents, detergents for clothing; perfumes for the cosmetics industry, the perfume industry and the industry of detergents and housekeeping products.



**Application Number** 2,106,902  
**Language of Application** English

**Filing Date** 2021-05-12

## APPLICANT AND AGENT DETAILS

### Applicant

Dalian haolijun Technology Development Co.,  
Ltd  
No.1, 18 / F  
167 Lu Xun Rd.  
Zhongshan Dist.  
Dalian, Liaoning,  
CHINA

### Agent

MILTONS IP/P.I.  
#200-15 Fitzgerald Road, Ottawa, ONTARIO,  
K2H9G1

## TRADEMARK DETAILS

# Grosee

### Trademark Type

Standard Characters

### Goods

#### Class 28

pet toys; puzzles; bats for games; nets for sports; abdominal benches for exercise; climbers' harness; sports gloves; ornaments and decorations for Christmas trees; protective padding for playing sports; in-line roller skates; inflatable pools for recreational use; Christmas tree stands; sports balls; pumps specially adapted for use with balls for games; needles for pumps for inflating balls for games; board games; playing cards; chess sets; kites; swings.

**Application Number** 2,106,908  
**Language of Application** English

**Filing Date** 2021-05-12

## **APPLICANT DETAILS**

### **Applicant**

Luckys Exotic Bodega Corp.  
1706-945 Marine Dr  
West Vancouver  
BRITISH COLUMBIA  
V7T1A8

## **TRADEMARK DETAILS**

# **LUCKY'S EXOTIC BODEGA**

### **Trademark Type**

Standard Characters

### **Disclaimer**

The right to the exclusive use of the word LUCKY'S is disclaimed apart from the trademark.

### **Services**

#### **Class 35**

(1) business management advisory services relating to franchising; operation of grocery store; providing assistance in the field of business management within the framework of a franchise contract; retail convenience store services; retail grocery store services

(2) offering technical assistance in the establishment and operation of convenience store franchises;

**Application Number** 2,106,913  
**Language of Application** English

**Filing Date** 2021-05-12

## APPLICANT AND AGENT DETAILS

### Applicant

Shenzhen Keruilong Technology Co., Ltd.  
C1202, Block C, Xixintian Century Business  
Center  
Shixia North Second Street, Shixia Community  
Fubao Street, Futian District  
Shenzhen,  
CHINA

### Agent

MILTONS IP/P.I.  
#200-15 Fitzgerald Road, Ottawa, ONTARIO,  
K2H9G1

## TRADEMARK DETAILS

# Keriloo

### Trademark Type

Standard Characters

### Goods

#### Class 28

inflatable beach balls; sports balls; play balloons; toy balloons; playing balls; needles for pumps for inflating balls for games; party balloons; water guns; toy cookware; toy cars; plush toys; party hats; toy building blocks.

**Application Number** 2,106,926  
**Language of Application** English

**Filing Date** 2021-05-13

## APPLICANT AND AGENT DETAILS

### Applicant

Yantai Lvlin Tools Co., Ltd.  
(Shandong) Pilot Free Trade Zone, No. 2,  
Shaoguan Road  
the intersection of Guangzhou Road and  
Shenzhen Street  
Yantai Area  
Shandong Province,  
CHINA

### Agent

XIN XU  
(Fang An Law PC), Suite 300 & 306, 5500  
North Service Rd., Burlington, ONTARIO,  
L7L6W6

## TRADEMARK DETAILS

### Trademark Type

Design

### Visual Representation

### Goods

#### Class 06

(1) iron wire; bolts of metal; hardware nails; hardware springs; Padlocks; vice claws of metal; tool boxes of metal

#### Class 07

(2) agricultural balers; agricultural cultivators; agricultural elevators; agricultural land fertilizing equipment; agricultural plows; agricultural reaper machines; agricultural seed planting machine; electric hammers; drilling machines for metalworking; drilling rigs; painting machines; Dynamos; electric welding machines; hand-held electric drills; hand-held electric hammers; hand-held power driven grinders; carpet cleaning machines; cleaning machines for ponds; floor cleaning machines; steam cleaning machines

**Class 08**

(3) hand-operated abrading instruments; hand-operated hand tools; hand-operated atomizers for agricultural purposes; broadforks for agricultural purposes; gardening tools; blades for hand saws; hand-operated riveting tools; Tweezers; pruning scissors

**Application Number** 2,106,935  
**Language of Application** English

**Filing Date** 2021-05-13

## APPLICANT DETAILS

### Applicant

SHENZHEN YOUMI INTELLIGENT  
TECHNOLOGY CO., LTD.  
Room 406&407, 4/F, The 4th Office,  
Chongwen Garden, No.1 Tangling Road  
Fuguang Community, Taoyuan Street,  
Nanshan District, Shenzhen, 518000,  
CHINA

## TRADEMARK DETAILS

# UMIDIGI

### Trademark Type

Standard Characters

### Goods

#### Class 09

Tablet computer; two-way radios; wearable activity trackers; network routers; cabinets for loudspeakers; video monitors; headphones; electric sockets; digital door locks; smart watches; facial recognition software; smart phones; cell phone cases; wireless headsets for smartphones; cinematographic projectors; video projectors; laboratory thermometers; infra-red thermometers; electronic door locks; electric storage batteries.

**Application Number** 2,106,948  
**Language of Application** English

**Filing Date** 2021-05-13

## APPLICANT AND AGENT DETAILS

### Applicant

2712218 Ontario Inc.  
45 Connie Crescent #A  
Concord  
ONTARIO  
L4K1L3

### Agent

CHITIZ PATHAK LLP  
77 King Street West, TD North Tower, Suite  
700, P.O. Box 118, Toronto, ONTARIO,  
M5K1G8

## TRADEMARK DETAILS

# ERGO

### Trademark Type

Standard Characters

### Goods

#### Class 24

Sheets; mattress protectors; weighted blankets; pillow protectors

**Application Number** 2,106,953  
**Language of Application** English

**Filing Date** 2021-05-13

## **APPLICANT AND AGENT DETAILS**

### **Applicant**

B&G Foods North America, Inc.  
Four Gatehall Drive, Suite 110  
Parsippany, NJ 07054  
UNITED STATES OF AMERICA

### **Agent**

DEETH WILLIAMS WALL LLP  
150 YORK STREET, SUITE 400, TORONTO,  
ONTARIO, M5H3S5

## **TRADEMARK DETAILS**

# **GREEN GIANT**

### **Trademark Type**

Standard Characters

### **Goods**

#### **Class 29**

Vegetable based snack foods



**Application Number** 2,106,954  
**Language of Application** English

**Filing Date** 2021-05-13

## APPLICANT AND AGENT DETAILS

### Applicant

B&G Foods North America, Inc.  
Four Gatehall Drive, Suite 110  
Parsippany, NJ 07054  
UNITED STATES OF AMERICA

### Agent

DEETH WILLIAMS WALL LLP  
150 YORK STREET, SUITE 400, TORONTO,  
ONTARIO, M5H3S5

## TRADEMARK DETAILS

### Trademark Type

Design

### Visual Representation



### Colour Claim

Colour is claimed as a feature of the trademark. The colour green is claimed as a feature of the mark. The mark consists of a man wearing a toga made of leaves and boots on his feet with the word "Green" to his left and the word "Giant" to his right with a valley behind him. The words "Green Giant" with the "i" dotted as a stylized leaf. The colour green appears in the wording "Green Giant" and the design of the stylized leaf, on the man and in the valley in the background. The colour white in the sky and in the foreground under the words Green Giant and the man indicates transparent areas.

### Goods

#### Class 29

Vegetable based snack foods

**Application Number** 2,106,970  
**Language of Application** English

**Filing Date** 2021-05-13

## APPLICANT AND AGENT DETAILS

### Applicant

Yiwu Target Electric Appliance Co., Ltd.  
No.17222, District Two of Yiwu International  
Trade City, Yiwu City  
Zhejiang Province, 318014  
CHINA

### Agent

BCF S.E.N.C.R.L./BCF LLP  
1100, boul. René-Lévesque Ouest, 25e Étage,  
Montréal, QUEBEC, H3B5C9

## TRADEMARK DETAILS

### Trademark Type

Design

### Visual Representation



### Goods

#### Class 08

Beard clippers; Electric razors; Non-electric razors; Electric hair clippers; Non-electric hair clippers; Electric and non-electric depilation appliances; Electric manicure sets; Electric hair curling irons; Non-electric curling irons; Hair crimping irons.

**Application Number** 2,106,974  
**Language of Application** English

**Filing Date** 2021-05-13

## APPLICANT AND AGENT DETAILS

### Applicant

Tracy Castro  
20285 Stewart Crescent Suite 402  
Maple Ridge  
BRITISH COLUMBIA  
V2X8G1

### Agent

ANDREI MINCOV  
(TRADEMARK FACTORY INTERNATIONAL  
INC.), 300 - 1055 W. Hastings St., Vancouver,  
BRITISH COLUMBIA, V6E2E9

## TRADEMARK DETAILS

# ATIVO

### Trademark Type

Standard Characters

### Goods

#### Class 03

(1) beauty serums; cosmetics; facial cream; facial emulsions; facial lotion; hair care preparations; shampoos and conditioners; skin care preparations; skin scrub

#### Class 05

(2) pediculicidal shampoos

#### Class 21

(3) combs for back-combing hair; cosmetic brushes; hair brushes

### Services

#### Class 35

(1) Retail store services featuring cosmetics; Online retail store services featuring cosmetics

#### Class 44

(2) cosmetic body care services; skin care salon services

**Application Number** 2,106,976  
**Language of Application** English

**Filing Date** 2021-05-13

## APPLICANT AND AGENT DETAILS

### Applicant

Anhui Xinyisheng Medical Technology Co., Ltd.  
No.999, North of the Intersection of Tonghe  
Road and  
G343, Si County  
Suzhou City, Anhui Province, 234000  
CHINA

### Agent

MARK W. TIMMIS  
(MARK TIMMIS LAW CORPORATION), 2595  
CAVENDISH AVENUE, VICTORIA, BRITISH  
COLUMBIA, V8R2G5

## TRADEMARK DETAILS

### Trademark Type

Design

### Visual Representation



### Goods

#### Class 09

(1) disposable gloves for laboratory use; fire resistant gloves; asbestos gloves for protection against accidents; clothing and gloves for use in welding for protection against accidents or injury; diving gloves; gloves for protection against X-rays for industrial purposes; chemical exposure protective clothing; garments and clothes for protection against fire; boots for protection against fire; insulated clothing for protection against accidents or injury

#### Class 10

(2) gloves for use in hospitals; mittens for medical use; gloves for medical purposes; gloves for massage; vibrators massagers; static electric therapy apparatus; hearing aids; babies' bottles; post-operative pressure garments; protective breathing masks for protection against viruses and germs

#### Class 21

(3) gloves for household purposes; gardening gloves; car washing mitts; oven mitts; kitchen mitts; polishing gloves; animal grooming gloves; dusting gloves; work gloves; household gloves for general use

**Application Number** 2,106,978  
**Language of Application** English

**Filing Date** 2021-05-13

## APPLICANT AND AGENT DETAILS

### Applicant

John Kim  
17 Mellowood Dr  
North York  
ONTARIO  
M2L2E4

### Agent

SMART & BIGGAR LP  
1100-150 York street, TORONTO, ONTARIO,  
M5H3S5

## TRADEMARK DETAILS

# JOOJOKI

### Trademark Type

Standard Characters

### Services

#### Class 43

udon and soba restaurant services; wine bars; snack bar and canteen services; snack bar services; snack-bars; take-away restaurant services; take-out restaurant services; tea bar services; tea room services; tea rooms; teahouse services; restaurant services; restaurant services featuring take-out services; restaurants; pubs; providing restaurant services; operation of pubs; personal chef services; Japanese restaurant services; juice bars; milk bar services; okonomiyaki restaurant services; cocktail lounges; coffee and juice bar services; coffee and tea bars; coffee shop services; coffee shops; coffee-house and snack-bar services; coffee-house services; café and snack-bar services; café services; cafe-restaurants; cafés; cafeteria and canteen services; cafeteria services; cafeterias; canteen services; carry-out restaurant services; bar and cocktail lounge services; bar and restaurant services; bar services; bistro services; brasserie services; brewpubs; buffet services for cocktail lounges

**Application Number** 2,106,981  
**Language of Application** English

**Filing Date** 2021-05-13

## APPLICANT AND AGENT DETAILS

### Applicant

Jiangsu xinkangyuan Medical Technology Co.,  
Ltd.  
Factory of No. 18, Zhusong Road, Suxitong  
Science and Technology Industrial Park  
Nantong City, Jiangsu Province, 226000  
CHINA

### Agent

MARK W. TIMMIS  
(MARK TIMMIS LAW CORPORATION), 2595  
CAVENDISH AVENUE, VICTORIA, BRITISH  
COLUMBIA, V8R2G5

## TRADEMARK DETAILS

### Trademark Type

Design

### Visual Representation



**NKONRE**  
**新康源**

### Foreign Character Transliteration

The transliteration provided by the applicant of the Chinese characters is "xinkangyuan".

### Goods

#### Class 09

(1) disposable gloves for laboratory use; fire resistant gloves; asbestos gloves for protection against accidents; clothing and gloves for use in welding for protection against accidents or injury; diving gloves; gloves for protection against X-rays for industrial purposes; chemical exposure protective clothing; garments and clothes for protection against fire; boots for protection against fire; insulated clothing for protection against accidents or injury

#### Class 10

(2) gloves for use in hospitals; mittens for medical use; gloves for medical purposes; gloves for massage; vibrators massagers; static electric therapy apparatus; hearing aids; babies' bottles; post-operative pressure garments; protective breathing masks for protection against viruses and germs

**Class 21**

(3) gloves for household purposes; gardening gloves; car washing mitts; oven mitts; kitchen mitts; polishing gloves; animal grooming gloves; dusting gloves; work gloves; household gloves for general use

**Application Number** 2,107,002  
**Language of Application** English

**Filing Date** 2021-05-13

## **APPLICANT AND AGENT DETAILS**

### **Applicant**

DeVry Greenhouses (1989) Ltd.  
49259 Castleman Road  
Chilliwack  
BRITISH COLUMBIA  
V2P6H4

### **Agent**

OYEN WIGGS GREEN & MUTALA LLP  
480-THE STATION, 601 WEST CORDOVA  
STREET, VANCOUVER, BRITISH  
COLUMBIA, V6B1G1

## **TRADEMARK DETAILS**

# **LETT'UCE GARDEN**

**Trademark Type**  
Standard Characters

### **Goods**

**Class 31**

Live plants.



**Application Number** 2,107,005  
**Language of Application** English

**Filing Date** 2021-05-13

## APPLICANT AND AGENT DETAILS

### Applicant

Bemis Manufacturing Company  
300 Mill Street  
Sheboygan Falls, WI 53085  
UNITED STATES OF AMERICA

### Agent

BERESKIN & PARR LLP/S.E.N.C.R.L., S.R.L.  
SCOTIA PLAZA, 40 KING STREET WEST,  
40th FLOOR, TORONTO, ONTARIO, M5H3Y2

## TRADEMARK DETAILS

### Trademark Type

Design

### Visual Representation

The logo features the word "Mayfair" in a large, elegant, cursive script. Below it, the words "BY BEMIS" are written in a smaller, clean, sans-serif, all-caps font.

### Goods

#### Class 11

toilet seats

### Claims

Priority Filing Date: February 10, 2021, Country or Office: UNITED STATES OF AMERICA,  
Application No: 90/522,683 in association with the same kind of goods

**Application Number** 2,107,031  
**Language of Application** English

**Filing Date** 2021-05-13

## APPLICANT AND AGENT DETAILS

### Applicant

The Coleman Company, Inc.  
3600 North Hydraulic  
Wichita, KS 67219  
UNITED STATES OF AMERICA

### Agent

GOWLING WLG (CANADA) LLP  
SUITE 1600, 1 FIRST CANADIAN PLACE, 100  
KING STREET WEST, TORONTO, ONTARIO,  
M5X1G5

## TRADEMARK DETAILS

# GET THE PARTY STARTED

### Trademark Type

Standard Characters

### Goods

#### Class 21

- (1) Insulating sleeve holders for beverage cans
- (2) tumbler drinking glasses; water bottles sold empty

**Application Number** 2,107,055  
**Language of Application** English

**Filing Date** 2021-05-13

## APPLICANT AND AGENT DETAILS

### Applicant

Retail Royalty Company, a Nevada, U.S.A.  
corporation  
101 Convention Center Drive  
Las Vegas, NV 89109  
UNITED STATES OF AMERICA

### Agent

OSLER, HOSKIN & HARCOURT LLP  
Suite 320, World Exchange Plaza, 100 Queen  
Street, Ottawa, ONTARIO, K1P1J9

## TRADEMARK DETAILS

# MAMA BY AERIE

### Trademark Type

Standard Characters

### Goods

#### Class 05

(1) Breast nursing pads.

#### Class 25

(2) Maternity clothing, namely, bras, bralettes, tops as clothing.

**Application Number** 2,107,073  
**Language of Application** English

**Filing Date** 2021-05-13

## APPLICANT AND AGENT DETAILS

### Applicant

Confirmed Automation Systems Inc.  
1651 Welch Street  
North Vancouver  
BRITISH COLUMBIA  
V7P3G9

### Agent

OYEN WIGGS GREEN & MUTALA LLP  
480-THE STATION, 601 WEST CORDOVA  
STREET, VANCOUVER, BRITISH  
COLUMBIA, V6B1G1

## TRADEMARK DETAILS

# PikAssist

### Trademark Type

Standard Characters

### Goods

#### Class 07

packaging machines for food

**Application Number** 2,107,075  
**Language of Application** English

**Filing Date** 2021-05-13

## APPLICANT DETAILS

### Applicant

Clear Ocean Seafood Ltd.  
2145-21331 Gordon Way  
Richmond  
BRITISH COLUMBIA  
V6W1J9

## TRADEMARK DETAILS

### Trademark Type

Design

### Visual Representation



### Colour Claim

Colour is claimed as a feature of the trademark. The two scallop shells design is in blue and the shadow of the shells is in yellow. The Chinese characters , which means scallops, is in yellow with a blue border.

### Foreign Character Translation

The translation provided by the applicant of the foreign characters "Kan", "Ji", "Kaiba" and Shira is "Sail", "Standing", "Shellfish" and "Pillar". As whole the translation is Scallop meat.

**Foreign Character Transliteration**

The transliteration provided by the applicant of the foreign characters is "Kan", "Ji", "Kaiba" and "Shira".

**Goods**

**Class 29**

seafood

**Application Number** 2,107,089  
**Language of Application** English

**Filing Date** 2021-05-13

## APPLICANT DETAILS

### Applicant

Yachao Yang  
Group 2, Xinzhuang Village, Tangzhuang  
Township  
Shangshui County  
Henan, 466199  
CHINA

## TRADEMARK DETAILS

# luxsego

### Trademark Type

Standard Characters

### Goods

#### Class 21

Cups; Mess-tins; dishes; Lunch boxes; Napkin rings; Garlic presses; chinaware; Perfume burners; Polishing leather; cosmetic brushes; Flower pots; Cake molds; ceramic mugs; unworked and semi-worked glass; Ice cube molds.

**Application Number** 2,107,098  
**Language of Application** English

**Filing Date** 2021-05-14

## APPLICANT AND AGENT DETAILS

### Applicant

Suqian shitouhua Technology Co., Ltd  
No. 310-03, Yigao Internet business park  
Yanghe Town, Yanghe New District  
Suqian City, 223725  
CHINA

### Agent

MILTONS IP/P.I.  
#200-15 Fitzgerald Road, Ottawa, ONTARIO,  
K2H9G1

## TRADEMARK DETAILS

# Fulmo

### Trademark Type

Standard Characters

### Goods

#### Class 10

ear picks; medical thermometers; dental excavators; spoons for administering medicine; cooling pads for first aid purposes; gloves for medical purposes; hearing aids; suture materials; ophthalmoscopes; medical and surgical catheters; acupuncture equipment; surgical clamps; dentures; dental drills; dental braces.



**Application Number** 2,107,103  
**Language of Application** English

**Filing Date** 2021-05-14

## APPLICANT DETAILS

### Applicant

Zhang Kaiting  
No.261, Gaode 1st Street, Haicheng District  
Beihai City, Guangxi,  
CHINA

## TRADEMARK DETAILS

# HollGink

### Trademark Type

Standard Characters

### Goods

#### Class 28

stress relief exercise balls; yoga swings; needles for pumps for inflating balls for games; exercise pulleys; water toys; wrist guards for athletic use; camouflage screens for hunting purposes; swimming floats for recreational use; fishing tackle boxes; yoga straps; yoga blocks; ribbons specially adapted for rhythmic sportive gymnastics; handballs; swimming pool air floats; swimming rings; knee pads for athletic use; jump ropes; fishing lines; punching balls for boxing; boomerangs;

**Application Number** 2,107,104  
**Language of Application** English

**Filing Date** 2021-05-14

## **APPLICANT AND AGENT DETAILS**

### **Applicant**

JAMMERS APPAREL GROUP  
2000 ONESIME GAGNON  
LACHINE  
QUEBEC  
H8T3M8

### **Agent**

SELENA ALTRO  
4141 SHERBROOKE ST. W., SUITE 650,  
WESTMOUNT, QUEBEC, H3Z1B8

## **TRADEMARK DETAILS**

# **LOVE & DREAMS**

### **Trademark Type**

Standard Characters

### **Goods**

#### **Class 25**

CLOTHING, NAMELY, SLEEPWEAR, LOUNGEWEAR, LINGERIE, UNDERGARMENTS,  
UNDERWEAR, BRAS, SWEAT PANTS, SWEAT SHIRTS, SHORTS AND T-SHIRTS;

**Application Number** 2,107,105  
**Language of Application** English

**Filing Date** 2021-05-14

## **APPLICANT AND AGENT DETAILS**

### **Applicant**

JAMMERS APPAREL GROUP  
2000 ONESIME GAGNON  
LACHINE  
QUEBEC  
H8T3M8

### **Agent**

SELENA ALTRO  
4141 SHERBROOKE ST. W., SUITE 650,  
WESTMOUNT, QUEBEC, H3Z1B8

## **TRADEMARK DETAILS**

# **DREAM BIG PEACE OUT**

### **Trademark Type**

Standard Characters

### **Goods**

#### **Class 25**

CLOTHING, NAMELY, SLEEPWEAR, LOUNGEWEAR, LINGERIE, UNDERGARMENTS,  
UNDERWEAR, BRAS, SWEAT PANTS, SWEAT SHIRTS, SHORTS AND T-SHIRTS;

**Application Number** 2,107,107  
**Language of Application** English

**Filing Date** 2021-05-14

## APPLICANT AND AGENT DETAILS

### Applicant

Shiwu Liu  
Room 701, Building 2, No. 25, Gangqian West  
Road  
Licheng Street  
Zengcheng City, Guangdong Province,  
CHINA

### Agent

XIN XU  
(Fang An Law PC), Suite 300 & 306, 5500  
North Service Rd., Burlington, ONTARIO,  
L7L6W6

## TRADEMARK DETAILS

# saviland

### Trademark Type

Standard Characters

### Goods

#### Class 03

nail art stickers; nail gel; nail polish; nail polish base coat; nail polish pens; nail polish removers; nail polish remover pens; nail polish top coat; nail polishing powder; sun care lotions; preparations for removing gel nails; cosmetic nail care preparations; adhesives for affixing false hair; lip cream; beauty masks; make-up preparations; false eyelashes; Cosmetics; cosmetic pencils; make-up removing preparations; eyebrow pencils; Mascara; lip glosses; eye shadow; Lipsticks; facial cleansing milk; facial cream

**Application Number** 2,107,108  
**Language of Application** English

**Filing Date** 2021-05-14

## APPLICANT AND AGENT DETAILS

### Applicant

JAMMERS APPAREL GROUP  
2000 ONESIME GAGNON  
LACHINE  
QUEBEC  
H8T3M8

### Agent

SELENA ALTRO  
4141 SHERBROOKE ST. W., SUITE 650,  
WESTMOUNT, QUEBEC, H3Z1B8

## TRADEMARK DETAILS

# PLD NATION

### Trademark Type

Standard Characters

### Goods

#### Class 18

(1) CLOTHING FOR PETS;

#### Class 25

(2) CLOTHING, NAMELY, SLEEPWEAR, LOUNGEWEAR, LINGERIE, UNDERGARMENTS, UNDERWEAR, BRAS, SWEAT PANTS, SWEAT SHIRTS, SHORTS AND T-SHIRTS;

**Application Number** 2,107,109  
**Language of Application** English

**Filing Date** 2021-05-14

## APPLICANT AND AGENT DETAILS

### Applicant

JAMMERS APPAREL GROUP  
2000 ONESIME GAGNON  
LACHINE  
QUEBEC  
H8T3M8

### Agent

SELENA ALTRO  
4141 SHERBROOKE ST. W., SUITE 650,  
WESTMOUNT, QUEBEC, H3Z1B8

## TRADEMARK DETAILS

# PLD BLUE

### Trademark Type

Standard Characters

### Goods

#### Class 25

CLOTHING, NAMELY, SLEEPWEAR, LOUNGEWEAR, LINGERIE, UNDERGARMENTS,  
UNDERWEAR, BRAS, SWEAT PANTS, SWEAT SHIRTS, SHORTS AND T-SHIRTS;

**Application Number** 2,107,174  
**Language of Application** English

**Filing Date** 2021-05-14

## APPLICANT AND AGENT DETAILS

**Applicant**  
JAMMERS APPAREL GROUP  
2000 ONESIME GAGNON  
LACHINE  
QUEBEC  
H8T3M8

**Agent**  
SELENA ALTRO  
4141 SHERBROOKE ST. W., SUITE 650,  
WESTMOUNT, QUEBEC, H3Z1B8

## TRADEMARK DETAILS

**Trademark Type**  
Design

**Visual Representation**

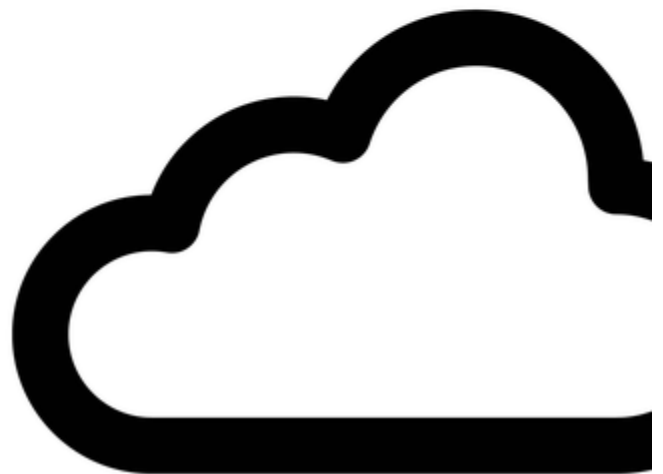

**Goods**

**Class 18**

(1) CLOTHING FOR PETS;

**Class 25**

(2) CLOTHING, NAMELY, SLEEPWEAR, LOUNGEWEAR, LINGERIE, UNDERGARMENTS, UNDERWEAR, BRAS, SWEAT PANTS, SWEAT SHIRTS, SHORTS AND T-SHIRTS;



**Application Number** 2,107,180  
**Language of Application** English

**Filing Date** 2021-05-14

## APPLICANT AND AGENT DETAILS

### Applicant

The Pillsbury Company, LLC  
Number One General Mills Boulevard  
Minneapolis, MN 55426  
UNITED STATES OF AMERICA

### Agent

SMART & BIGGAR LP  
SUITE 900, 55 METCALFE STREET, P.O.  
BOX 2999, STATION D, OTTAWA, ONTARIO,  
K1P5Y6

## TRADEMARK DETAILS

# POPPINS'

### Trademark Type

Standard Characters

### Goods

#### Class 30

Dough

### Claims

Priority Filing Date: January 18, 2021, Country or Office: UNITED STATES OF AMERICA,  
Application No: 90/471,647 in association with the same kind of goods

**Application Number** 2,107,215  
**Language of Application** English

**Filing Date** 2021-05-14

## **APPLICANT AND AGENT DETAILS**

### **Applicant**

Wu Xiaorong  
No.4,Ln.6,Xikeng Residential Area,Liangying  
Town,Chaonan Dist.  
Shantou,Guangdong, 515141  
CHINA

### **Agent**

ANITA MAR  
dba Trademark Angel, Suite 521, 6-2557  
Dougall Avenue, Windsor, ONTARIO, N8X1T5

## **TRADEMARK DETAILS**

### **Trademark Type**

Design

### **Visual Representation**



**JIEBA**

**Goods****Class 09**

visors for helmets; protective face-shields for protective helmets; dust masks; solderers' helmets; workmen's protective face-shields; asbestos gloves for protection against accidents; gloves for divers; dust protective masks; divers' masks; knee-pads for workers; protective helmets for sports; horse riding helmets; head guards for sports; motorcycle helmets;

**Application Number** 2,107,217  
**Language of Application** English

**Filing Date** 2021-05-14

## APPLICANT AND AGENT DETAILS

### Applicant

HEFEI SHANGLING TRADING CO., LTD  
Room 304-16, Nangang Science Park  
Intersection of Dabieshan Road and Tianlong  
Road, Hi-tech Zone  
Hefei City, Anhui Province, 230000  
CHINA

### Agent

ANITA MAR  
dba Trademark Angel, Suite 521, 6-2557  
Dougall Avenue, Windsor, ONTARIO, N8X1T5

## TRADEMARK DETAILS

# Pimoys

### Trademark Type

Standard Characters

### Goods

#### Class 21

bottle openers; cake molds; china ornaments; chinaware; cleaning and polishing cloths; colanders; combs for back-combing hair; cosmetic brushes; dental floss; dispensers for liquid soap for household purposes; drinking glasses; dustbins; dusting cloths; eyeliner brushes; feeding troughs; gardening gloves; glass carafes; ice cube molds; interdental brushes for cleaning the teeth; nail brushes;

**Application Number** 2,107,227  
**Language of Application** English

**Filing Date** 2021-05-14

## APPLICANT AND AGENT DETAILS

### Applicant

PetSmart Home Office, Inc.  
19601 N. 27th Avenue  
Phoenix, AZ 85027  
UNITED STATES OF AMERICA

### Agent

BORDEN LADNER GERVAIS LLP  
ATTN: INTELLECTUAL PROPERTY  
DEPARTMENT, 1000 DE LA GAUCHETIERE  
STREET WEST, SUITE 900, MONTREAL,  
QUEBEC, H3B5H4

## TRADEMARK DETAILS

# SO MELON-DRAMATIC

### Trademark Type

Standard Characters

### Goods

Class 28

Pet toys

**Application Number** 2,107,238  
**Language of Application** English

**Filing Date** 2021-05-14

## APPLICANT AND AGENT DETAILS

### Applicant

PetSmart Home Office, Inc.  
19601 N. 27th Avenue  
Phoenix, AZ 85027  
UNITED STATES OF AMERICA

### Agent

BORDEN LADNER GERVAIS LLP  
ATTN: INTELLECTUAL PROPERTY  
DEPARTMENT, 1000 DE LA GAUCHETIERE  
STREET WEST, SUITE 900, MONTREAL,  
QUEBEC, H3B5H4

## TRADEMARK DETAILS

# TINY TALES

### Trademark Type

Standard Characters

### Goods

#### Class 18

Animal carriers

**Application Number** 2,107,277  
**Language of Application** English

**Filing Date** 2021-05-14

## APPLICANT AND AGENT DETAILS

### Applicant

VERTICAL ROOTS, LLC  
1008 Clements Crest Lane  
Suite 130  
Charleston, SC 29492  
UNITED STATES OF AMERICA

### Agent

MILLER IP LAW  
84 Neilson Drive, Toronto, ONTARIO, M9C1V7

## TRADEMARK DETAILS

### Trademark Type

Design

### Visual Representation

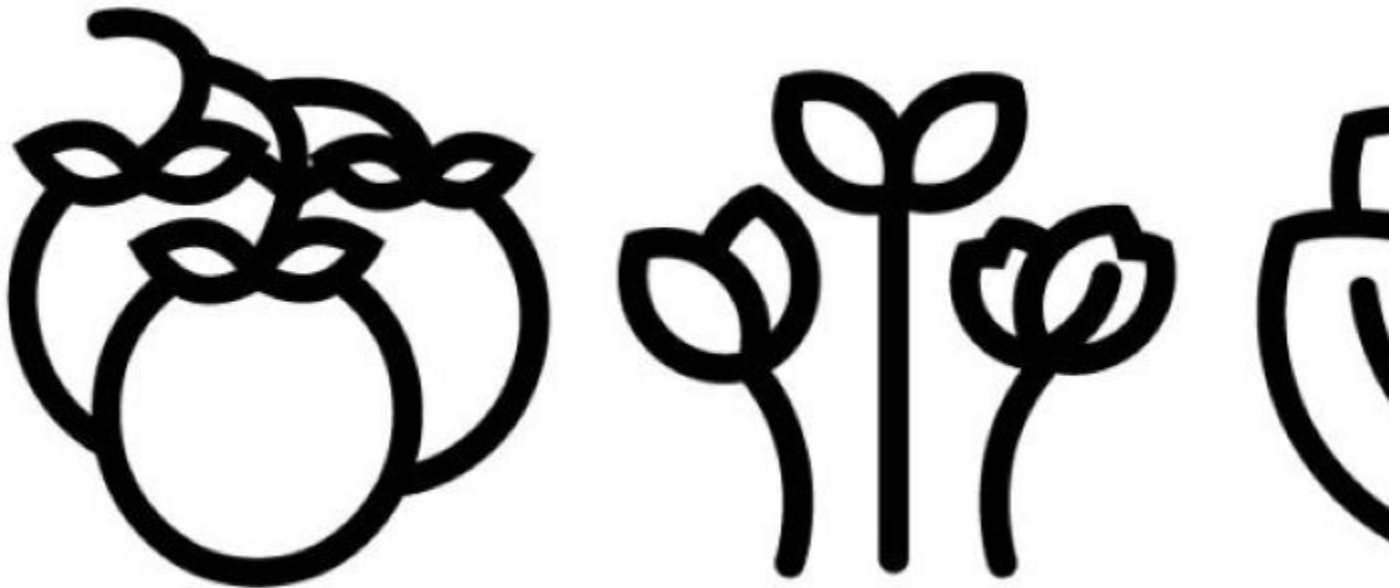

### Goods

#### Class 31

Lettuce, fresh; vegetables, fresh

### Claims

Priority Filing Date: May 10, 2021, Country or Office: UNITED STATES OF AMERICA, Application No: 90/700,419 in association with the same kind of goods

**Application Number** 2,107,292  
**Language of Application** English

**Filing Date** 2021-05-14

## APPLICANT AND AGENT DETAILS

### Applicant

Jarritos, Inc.  
500 W. Overland Ave.  
Suite 300  
El Paso, TX 79901  
UNITED STATES OF AMERICA

### Agent

OYEN WIGGS GREEN & MUTALA LLP  
480-THE STATION, 601 WEST CORDOVA  
STREET, VANCOUVER, BRITISH  
COLUMBIA, V6B1G1

## TRADEMARK DETAILS

# THE OFFICIAL DRINK OF TACOS

### Trademark Type

Standard Characters

### Goods

#### Class 32

fruit flavored soft drinks; soft drinks



**Application Number** 2,107,293  
**Language of Application** English

**Filing Date** 2021-05-14

## APPLICANT AND AGENT DETAILS

### Applicant

The LYCRA Company UK Limited  
One St. Peter's Square  
Manchester M3 3DE,  
UNITED KINGDOM

### Agent

BORDEN LADNER GERVAIS LLP  
World Exchange Plaza, 100 Queen Street,  
Suite 1300, Ottawa, ONTARIO, K1P1J9

## TRADEMARK DETAILS

# LYCRA ENVIROFIT

### Trademark Type

Standard Characters

### Goods

#### Class 05

(1) disposable baby diapers, disposable baby swim pants, disposable training pants, disposable adult incontinence pants and pads, disposable feminine sanitary pads

#### Class 22

(2) textile fibers

**Application Number** 2,107,294  
**Language of Application** English

**Filing Date** 2021-05-14

## APPLICANT AND AGENT DETAILS

### Applicant

The LYCRA Company UK Limited  
One St. Peter's Square  
Manchester M3 3DE,  
UNITED KINGDOM

### Agent

BORDEN LADNER GERVAIS LLP  
World Exchange Plaza, 100 Queen Street,  
Suite 1300, Ottawa, ONTARIO, K1P1J9

## TRADEMARK DETAILS

### Trademark Type

Design

### Visual Representation



**Goods****Class 05**

(1) disposable baby diapers, disposable baby swim pants, disposable training pants, disposable adult incontinence pants and pads, disposable feminine sanitary pads

**Class 22**

(2) textile fibers

**Application Number** 2,107,303  
**Language of Application** English

**Filing Date** 2021-05-14

## APPLICANT DETAILS

**Applicant**  
YINGCHUN HUANG  
4 Citadel Estates Terr NW  
Calgary  
ALBERTA  
T3G4S4

## TRADEMARK DETAILS

**Trademark Type**  
Design

**Visual Representation**



**Services**

**Class 42**

Design and development of computer hardware and software.

**Application Number** 2,107,322  
**Language of Application** English

**Filing Date** 2021-05-15

## **APPLICANT AND AGENT DETAILS**

### **Applicant**

AMPLIFIEDAG, INC.  
1008 Clements Crest Lane  
Suite 130  
Charleston, SC 29492  
UNITED STATES OF AMERICA

### **Agent**

MILLER IP LAW  
84 Neilson Drive, Toronto, ONTARIO, M9C1V7

## **TRADEMARK DETAILS**

# **AMPLIFIED AG**

### **Trademark Type**

Standard Characters

### **Goods**

#### **Class 31**

Vegetables, fresh

**Application Number** 2,107,324  
**Language of Application** English

**Filing Date** 2021-05-15

## APPLICANT AND AGENT DETAILS

**Applicant**  
AMPLIFIEDAG, INC.  
1008 Clements Crest Lane  
Suite 130  
Charleston, SC 29492  
UNITED STATES OF AMERICA

**Agent**  
MILLER IP LAW  
84 Neilson Drive, Toronto, ONTARIO, M9C1V7

## TRADEMARK DETAILS

**Trademark Type**  
Design

**Visual Representation**

The logo for 'AmplifiedA' features the word 'Amplified' in a bold, sans-serif font. The letter 'A' at the end is significantly larger and stylized, with a hand-like shape integrated into its left side, as if holding or amplifying the word.

**Goods**

**Class 31**

Vegetables, fresh

**Application Number** 2,107,331  
**Language of Application** English

**Filing Date** 2021-05-15

## **APPLICANT DETAILS**

**Applicant**  
Nikola Damulewicz  
75 St Claire Ave  
Nepean  
ONTARIO  
K2G2A5

## **TRADEMARK DETAILS**

# **MODA LASH**

**Trademark Type**  
Standard Characters

### **Foreign Character Translation**

The translation provided by the applicant of the Italian word MODA is FASHION.

### **Goods**

#### **Class 03**

Eyelash extension supplies; eyelash supplies; beauty supplies; eyelash extension training manual and kits; Artificial eyelashes; cosmetic preparation for eye lashes; cosmetic kits; Artificial eyelash and eyelash application accessories

### **Services**

#### **Class 44**

Beauty salon services; eyelash extension services; live and online eyelash extension training services; eyelash extension perming and lifting services;

**Application Number** 2,107,344  
**Language of Application** English

**Filing Date** 2021-05-17

## **APPLICANT DETAILS**

### **Applicant**

Foshan Langzhao Lighting Co., Ltd.  
301 and 302, Building 2, Shunde Zhifuyuan,  
No. 8 Second Ring Road  
Gaozan Village Committee, Xingtan Town,  
Shunde District  
Foshan City,  
CHINA

## **TRADEMARK DETAILS**

# **BESTIELAM**

### **Trademark Type**

Standard Characters

### **Goods**

#### **Class 11**

Standard lamps; Electric lamps; Ceiling lights; Book lights; Luminaires; Lamp bulbs; Led luminaires; Accent lights for indoor use; Searchlights; Sun lamps; Incandescent lamps; Solar powered lamps; Lighting fixtures; Lighting diffusers; Fluorescent lighting fixtures; Electric track lighting units; String lights for festive decoration;



**Application Number** 2,107,349  
**Language of Application** English

**Filing Date** 2021-05-17

## APPLICANT AND AGENT DETAILS

### Applicant

Xifeng Lian  
No. 10 Huating Kiln, Qianlian Village  
Gaiwei Town  
Xianyou County, Fujian Province,  
CHINA

### Agent

XIN XU  
(Fang An Law PC), Suite 300 & 306, 5500  
North Service Rd., Burlington, ONTARIO,  
L7L6W6

## TRADEMARK DETAILS

# SOG

### Trademark Type

Standard Characters

### Goods

#### Class 14

alarm clocks; Amulets; beads for making jewellery; Bracelets; charms for key chains; clasps for jewellery; Clocks; clocks and watches; costume jewellery; cuff links; cultured pearls; desk clocks; Diamonds; Earrings; figurines of precious metal; gold thread jewellery; hat jewellery; Jewellery; jewellery chains; jewellery charms; jewellery of yellow amber; jewellery boxes; jewellery brooches; jewellery hat pins; key chains; key chains of precious metal; key rings of precious metal; Locketts; movements for clocks and watches; Necklaces; ornamental pins; shoe ornaments of precious metal; paste jewellery; Pearls; Pendants; jewellery pins; alloys of precious metal; precious stones; rings being jewellery; shoe jewellery; Silver; silver jewellery; statues of precious metal; straps for wristwatches; tie-pins of precious metal; tie clips; tie pins; watch bands; watch chains; watch fobs; watch pouches; Watches; works of art of precious metals; wristwatches

**Application Number** 2,107,350  
**Language of Application** English

**Filing Date** 2021-05-17

## APPLICANT AND AGENT DETAILS

### Applicant

Xifeng Lian  
No. 10 Huating Kiln, Qianlian Village  
Gaiwei Town  
Xianyou County, Fujian Province,  
CHINA

### Agent

XIN XU  
(Fang An Law PC), Suite 300 & 306, 5500  
North Service Rd., Burlington, ONTARIO,  
L7L6W6

## TRADEMARK DETAILS

# lenoup

### Trademark Type

Standard Characters

### Goods

#### Class 20

air mattresses; Armchairs; beds for household pets; plastic storage bins; Bolsters; Bookcases; Chairs; chests of drawers; packaging containers of plastic; Cushions; Desks; bedroom furniture; dining room furniture; garden furniture; kitchen furniture; living room furniture; office furniture; school furniture; furniture chests; glass door fittings; display counters; sales counters; camping mattresses; jewellery organizer display stands; display boards; Lockers; Cushions; Mattresses; metal cabinets; metal camping furniture; metal shelving; metal vice benches being furniture; moldings for picture frames; sleeping mats; plastic shipping and storage boxes; boxes of wood and plastic; plastic tool boxes sold empty; industrial packaging containers of bamboo; industrial packaging containers of wood; pet cushions; rocking chairs; folding seats; standing desks; Stools; Tables; toy boxes and chests; Wardrobes; window blinds; window shades; writing desks; Chairs; Pillows; sleeping pads; inflatable pillows

**Application Number** 2,107,352  
**Language of Application** English

**Filing Date** 2021-05-17

## APPLICANT AND AGENT DETAILS

### Applicant

Xifeng Lian  
No. 10 Huating Kiln, Qianlian Village  
Gaiwei Town  
Xianyou County, Fujian Province,  
CHINA

### Agent

XIN XU  
(Fang An Law PC), Suite 300 & 306, 5500  
North Service Rd., Burlington, ONTARIO,  
L7L6W6

## TRADEMARK DETAILS

# MHKBD

### Trademark Type

Standard Characters

### Goods

#### Class 20

air mattresses; Armchairs; beds for household pets; plastic storage bins; Bolsters; Bookcases; Chairs; chests of drawers; packaging containers of plastic; Cushions; Desks; bedroom furniture; dining room furniture; garden furniture; kitchen furniture; living room furniture; office furniture; school furniture; furniture chests; glass door fittings; display counters; sales counters; camping mattresses; jewellery organizer display stands; display boards; Lockers; Cushions; Mattresses; metal cabinets; metal camping furniture; metal shelving; metal vice benches being furniture; moldings for picture frames; sleeping mats; plastic shipping and storage boxes; boxes of wood and plastic; plastic tool boxes sold empty; industrial packaging containers of bamboo; industrial packaging containers of wood; pet cushions; rocking chairs; folding seats; standing desks; Stools; Tables; toy boxes and chests; Wardrobes; window blinds; window shades; writing desks; Chairs; Pillows; sleeping pads; inflatable pillows

**Application Number** 2,107,355  
**Language of Application** English

**Filing Date** 2021-05-17

## APPLICANT AND AGENT DETAILS

### Applicant

Xifeng Lian  
No. 10 Huating Kiln, Qianlian Village  
Gaiwei Town  
Xianyou County, Fujian Province,  
CHINA

### Agent

XIN XU  
(Fang An Law PC), Suite 300 & 306, 5500  
North Service Rd., Burlington, ONTARIO,  
L7L6W6

## TRADEMARK DETAILS

# TamBee

### Trademark Type

Standard Characters

### Goods

#### Class 21

Bakeware; baking mats; electric bottle openers; bottle openers; Bowls; cake molds; cocktail shakers; cookery molds; cookie cutters; cooking pots; cooking utensils; cosmetic brushes; cosmetic spatulas; crumb-sweepers; electrical toothbrushes; fitted vanity cases; garbage cans; gardening gloves; glass carafes; glass jars; Jugs; knife rests for the table; make-up brushes; non-electric carpet sweepers; non-electric kettles; Ovenware; pitchers; Plates; Pots; shoe brushes; shoe shine cloths; tea sets; thermally insulated containers for food; tooth brushes; wine glasses; wine pourers; caddies for holding hair accessories; brushes for cleaning tanks and containers; electric combs; cotton waste for cleaning; basting spoons for kitchen use; non-electric Japanese cast iron kettles [tetsubin]; food storage containers; make-up sponges; china ornaments; flower pots; cups and mugs; small jugs; cleaning, dusting and polishing cloths

**Application Number** 2,107,356  
**Language of Application** English

**Filing Date** 2021-05-17

## APPLICANT AND AGENT DETAILS

### Applicant

Xifeng Lian  
No. 10 Huating Kiln, Qianlian Village  
Gaiwei Town  
Xianyou County, Fujian Province,  
CHINA

### Agent

XIN XU  
(Fang An Law PC), Suite 300 & 306, 5500  
North Service Rd., Burlington, ONTARIO,  
L7L6W6

## TRADEMARK DETAILS

# ELETON

### Trademark Type

Standard Characters

### Goods

#### Class 24

Bedspreads; Brocades; Coverlets; Pillowcases; Quilts; bath towels; large bath towels; bed blankets; bed covers; bed covers of paper; bed linen; bed sheets; fabrics made of synthetic materials; woolen blankets; woolen fabric; silk fabrics; cloth flags; cotton cloth; cotton fabric; curtain holders of textile material; diaper changing cloths for babies; Curtains; esparto fabric; fabric flags; fabric valances; furnishing and upholstery fabrics; fabrics for textile use; face cloths; face towels of textiles; felt cloth; felt and non-woven textile fabrics; flax cloth; fleece blankets; furniture coverings made of plastic materials; gauze fabric; hand towels of textile; handkerchiefs of textile; hemp cloth; upholstery fabrics; labels of textile; lingerie fabric; mattress covers; bed pads; mosquito nets; non-woven textile fabrics; nylon fabric; paper bed covers; pillow shams; printed calico cloth; printers' blankets of textile; quilts of textile; serviettes of textile; silk fabrics for printing patterns; sleeping bag liners; table linen; table linen of textile; table napkins of textile; tablemats of textile; textile wall hangings; towelling coverlets; rayon fabric; wash cloths; woven fabrics

**Application Number** 2,107,357  
**Language of Application** English

**Filing Date** 2021-05-17

## APPLICANT AND AGENT DETAILS

### Applicant

Xifeng Lian  
No. 10 Huating Kiln, Qianlian Village  
Gaiwei Town  
Xianyou County, Fujian Province,  
CHINA

### Agent

XIN XU  
(Fang An Law PC), Suite 300 & 306, 5500  
North Service Rd., Burlington, ONTARIO,  
L7L6W6

## TRADEMARK DETAILS

# SANPU

### Trademark Type

Standard Characters

### Goods

#### Class 28

arcade game machines; arcade video game machines; arm guards for athletic use; artificial fishing bait; chest expanders; controllers for game consoles; controllers for toy cars; controllers for toy planes; electronic action toys; toy building blocks; exercise balls; gyroscopes and flight stabilizers for model aircraft; knee pads for athletic use; toy vehicles; hand wraps for sports use; parlour games; inflatable pool toys; remote-controlled toy vehicles; rods for fishing; scale-model vehicles; plush toys; toy robots; toy air pistols; toy aircraft; artificial Christmas trees incorporating lights; video game joysticks; video game machines; weightlifting belts; wrist weights for exercise; ankle weights for exercise

**Application Number** 2,107,358  
**Language of Application** English

**Filing Date** 2021-05-17

## APPLICANT AND AGENT DETAILS

### Applicant

Xiutian Wen  
No.10, Jiuling Road, Fudong, Huangpu District  
Guangzhou,  
CHINA

### Agent

XIN XU  
(Fang An Law PC), Suite 300 & 306, 5500  
North Service Rd., Burlington, ONTARIO,  
L7L6W6

## TRADEMARK DETAILS

# Asmwo

### Trademark Type

Standard Characters

### Goods

#### Class 21

cooking utensils; pail containers; cookery moulds; bread-cases for kitchen use; chopping boards for kitchen use; cutting boards for the kitchen; graters for kitchen use; kitchen enamelware; kitchen pot lids; mortars for kitchen use; spatulas for kitchen use; glass dishes; drinking glasses; ceramic mugs; Earthenwares; Chinaware; drinking flasks; drinking cups; flower pots; Vases; piggy banks; Candelabras; perfume sprayers; window-boxes; perfume burners; gardening gloves

**Application Number** 2,107,366  
**Language of Application** English

**Filing Date** 2021-05-17

## APPLICANT AND AGENT DETAILS

### Applicant

Zhengyan Youjia Supply Chain (Zhuhai) Co.,  
Ltd.  
2014, 2nd Floor, No. 1206 , East of Jida  
Jiuzhou Avenue  
Zhuhai City,  
CHINA

### Agent

XIN XU  
(Fang An Law PC), Suite 300 & 306, 5500  
North Service Rd., Burlington, ONTARIO,  
L7L6W6

## TRADEMARK DETAILS

### Trademark Type

Design

### Visual Representation





**Goods****Class 26**

hair bands; Embroidery; embroidery for garments; lace and embroidery; decorative cords; textile ribbons for gift wrapping; textile bows for gift wrapping; haberdashery bows; hat pins for securing hats; ornamental patches for clothing; lace trimmings; hair ornaments; hair grips; brooches for clothing; hair accessories; hair curling pins; hair barrettes; hair pins; hair nets; bows for the hair; charms for pet collars; decorative charms for cell phones; decorative charms for eyewear; ribbons for the hair; artificial flowers; artificial garlands; wreaths of artificial flowers; artificial plants

**Application Number** 2,107,370  
**Language of Application** English

**Filing Date** 2021-05-17

## APPLICANT AND AGENT DETAILS

### Applicant

Beijing Zunxiang Time Technology Co., Ltd  
(No. A1061, Jianwai Juying Union Incubator)  
14th Floor, Building 118, Jianguo Road  
Chaoyang District  
Beijing, 100020  
CHINA

### Agent

MILTONS IP/P.I.  
#200-15 Fitzgerald Road, Ottawa, ONTARIO,  
K2H9G1

## TRADEMARK DETAILS

### Trademark Type

Design

### Visual Representation



### Goods

#### Class 11

Automatic faucets; air purifying units; air conditioners; Air conditioning installations for vehicles; air purifiers for household purposes; air humidifiers; Electric space heaters; Electric hot air hand dryers; air valves for steam heating installations; Aquarium filters; Aquarium lights; Bicycle lights; headlights for automobiles; Electric lanterns; Wall lamp; Led landscape lamp; Candle lanterns; Fluorescent lamps; Infrared lamp fixtures; LED luminaires

**Application Number** 2,107,371  
**Language of Application** English

**Filing Date** 2021-05-17

## APPLICANT AND AGENT DETAILS

### Applicant

Yiwu Hongqi Electronic Commerce Co., Ltd.  
Hepan shan village District C-23#  
Chengxi street  
Yiwu City, Zhejiang, 322000  
CHINA

### Agent

MILTONS IP/P.I.  
#200-15 Fitzgerald Road, Ottawa, ONTARIO,  
K2H9G1

## TRADEMARK DETAILS

### Trademark Type

Design

### Visual Representation



### Foreign Character Translation

The mark "GCHARAL" has no meaning in English. It is a coined word.

### Goods

#### Class 11

stoves; Japanese charcoal cooking stoves for household purposes (shichirin); electric cooktops; food dehydrators; Acetylene burners; Baking ovens for household purposes; Barbecue grills; electric cooking pots and pans; Bread baking machines; kitchen stoves; barbecues and grills; Clothes dryers; electric coffee machines; Deep fat fryers; electronic candles; Fireplaces; Electric grills; Electric indoor grills; Electric popcorn makers; Facial saunas; Ice machines; Wall lamp; Led landscape lamp

**Application Number** 2,107,404  
**Language of Application** English

**Filing Date** 2021-05-17

## APPLICANT AND AGENT DETAILS

### Applicant

Tsung-Tse HSIEH  
No. 20, Lane 30, Sec. 2, Hwei Rd.  
Tainan City, 704  
TAIWAN

### Agent

MOFFAT & CO.  
P.O. Box 2088, Station D, Ottawa, ONTARIO,  
K1P5W3

## TRADEMARK DETAILS

### Trademark Type

Design

### Visual Representation



**Foreign Character Translation**

The translation provided by the applicant of first two characters is "sun" and the second two characters is "Mr."

**Foreign Character Transliteration**

The transliteration provided by the applicant of the first character is "tai", the second is "yang", the third is "xian" and the last is "sheng".

**Goods****Class 30**

Beverages made of tea; coffee and tea

**Services****Class 43**

Coffee and tea bars

**Application Number** 2,107,480  
**Language of Application** English

**Filing Date** 2021-05-17

## APPLICANT AND AGENT DETAILS

### Applicant

Komos, Inc.  
55 Washington Street, Suite 312  
Brooklyn, NY 11201  
UNITED STATES OF AMERICA

### Agent

JENSEN IP  
234 - 38 Auriga Drive, Ottawa, ONTARIO,  
K2E8A5

## TRADEMARK DETAILS

# KOMOS

### Trademark Type

Standard Characters

### Goods

#### Class 33

Tequila;

**Application Number** 2,107,481  
**Language of Application** English

**Filing Date** 2021-05-17

## APPLICANT AND AGENT DETAILS

### Applicant

Komos, Inc.  
55 Washington Street, Suite 312  
Brooklyn, NY 11201  
UNITED STATES OF AMERICA

### Agent

JENSEN IP  
234 - 38 Auriga Drive, Ottawa, ONTARIO,  
K2E8A5

## TRADEMARK DETAILS

# CASA KOMOS

### Trademark Type

Standard Characters

### Goods

#### Class 33

Tequila;

**Application Number** 2,107,573  
**Language of Application** English

**Filing Date** 2021-05-17

## APPLICANT AND AGENT DETAILS

### Applicant

Treeline Collective Inc.  
200 - 38018 Cleveland Ave  
Squamish  
BRITISH COLUMBIA  
V8B0B4

### Agent

KEN POULIN  
(Evermark Trademarks), 1302 - 1323 Homer  
Street, Vancouver, BRITISH COLUMBIA,  
V6B5T1

## TRADEMARK DETAILS

# TREELINE COLLECTIVE

### Trademark Type

Standard Characters

### Goods

#### Class 09

(1) eye glass chains; eye glass cords; sunglasses

#### Class 14

(2) bracelets; custom jewelry; earrings; jewelry; jewelry chains; jewelry charms; lockets; medals; necklaces; rings being jewellery; silver; silver jewelry

#### Class 24

(3) baby blankets; bath towels; beach towels; bed blankets; bed covers; bed linen; bed sheets; bedspreads; blanket throws; blankets; blankets for outdoor use; children's blankets; cloth towels; comforters; cotton towels; coverlets; cushion covers; duvet covers; pillow covers; pillowcases; quilts; sheets; textile fabrics; textile wall hangings; towels of textile; travelling rugs; woolen blankets; woolen fabric

#### Class 25

(4) athletic clothing; athletic footwear; baby clothing; bathing drawers; bathing suits; bathing trunks; beach clothes; beach shoes; belts; bikinis; casual clothing; casual footwear; children's clothing; climbing footwear; dress clothing; dresses; hats; jackets; jeans; jumper dresses; jumpers; knit tops; ponchos; pullovers; sandals; scarves; shoes; socks; sweaters; swimsuits; t-shirts; tank tops

### Services

#### Class 35

retail and online retail store services featuring sunglasses, eyeglass chains, eyeglass cords jewelry chains, jewelry charms, lockets, medals, silver, bracelets, custom jewelry, earrings, jewelry, necklaces, rings being jewellery, silver jewelry, bath towels, bed blankets, bed covers, bed linen, bed sheets, bedspreads, blanket throws, blankets for outdoor use, children's blankets, cloth towels, comforters, coverlets, cushion covers, duvet covers, pillow covers, pillowcases, quilts, sheets, textile fabrics, textile wall hangings, towels of textile, travelling rugs, woolen blankets, woolen fabric, baby blankets, beach towels, cotton towels, blankets, athletic footwear, bathing drawers, bathing suits, bathing trunks, beach clothes, beach shoes, belts, bikinis, casual footwear,



climbing footwear, dresses, jackets, jeans, jumper dresses, jumpers, knit tops, ponchos, pullovers, sandals, socks, sweaters, swimsuits, t-shirts, tank tops, athletic clothing, baby clothing, casual clothing, children's clothing, dress clothing, hats, scarves, shoes, rugs; wholesale sales of sunglasses, eyeglass chains, eyeglass cords jewelry chains, jewelry charms, locket, medals, silver, bracelets, custom jewelry, earrings, jewelry, necklaces, rings being jewellery, silver jewelry, bath towels, bed blankets, bed covers, bed linen, bed sheets, bedspreads, blanket throws, blankets for outdoor use, children's blankets, cloth towels, comforters, coverlets, cushion covers, duvet covers, pillow covers, pillowcases, quilts, sheets, textile fabrics, textile wall hangings, towels of textile, travelling rugs, woolen blankets, woolen fabric, baby blankets, beach towels, cotton towels, blankets, athletic footwear, bathing drawers, bathing suits, bathing trunks, beach clothes, beach shoes, belts, bikinis, casual footwear, climbing footwear, dresses, jackets, jeans, jumper dresses, jumpers, knit tops, ponchos, pullovers, sandals, socks, sweaters, swimsuits, t-shirts, tank tops, athletic clothing, baby clothing, casual clothing, children's clothing, dress clothing, hats, scarves, shoes, rugs

**Application Number** 2,107,586  
**Language of Application** English

**Filing Date** 2021-05-17

## APPLICANT AND AGENT DETAILS

### Applicant

HAIER US APPLIANCE SOLUTIONS, INC.  
Corporation Trust Center  
1209 Orange Street  
Wilmington, DE 19801  
UNITED STATES OF AMERICA

### Agent

CYNTHIA D. MASON  
(Mason Professional Corporation), 1000  
Innovation Drive, Suite 500, Kanata,  
ONTARIO, K2K3E7

## TRADEMARK DETAILS

# INSPIRAL

### Trademark Type

Standard Characters

### Goods

#### Class 11

Apparatus for cooking, namely, cooktops; Cooking ranges; Cooking stoves; Gas cooktops; Gas ranges; Gas stoves

### Claims

Priority Filing Date: November 18, 2020, Country or Office: UNITED STATES OF AMERICA,  
Application No: 90327771 in association with the same kind of goods

**Application Number** 2,107,608  
**Language of Application** English

**Filing Date** 2021-05-17

## APPLICANT AND AGENT DETAILS

### Applicant

Guangzhou Yuanhui Electronic Commerce Co., Ltd.  
Room 611, No. 9, Jieshun Road, Nancun Town Panyu District  
Guangzhou, Guangdong, 511442  
CHINA

### Agent

MILTONS IP/P.I.  
#200-15 Fitzgerald Road, Ottawa, ONTARIO, K2H9G1

## TRADEMARK DETAILS

### Trademark Type

Design

### Visual Representation



**3NDLESSBY**

### Goods

#### Class 28

waist trimmer exercise belts; exercise treadmills; free weights for physical exercise; gymnastic training stools; spring bars for exercising; Archery bow cases; mountaineering binding straps; Athletic protective elbow pads for skateboarding; Boomerangs; Pet toys; Chest expanders; Educational games for children; video game interactive control floor pads or mats; Action figure toys; Jigsaw puzzles; scale model cars; Radio-controlled toy vehicles; Toy cameras; Play tents; toys for babies

**Application Number** 2,107,610  
**Language of Application** English

**Filing Date** 2021-05-17

## APPLICANT AND AGENT DETAILS

### Applicant

Kunming Chengrong E-commerce Co., Ltd.  
Room 101, Unit 2, Building A20, Kunshiuan  
Group Co., Ltd.  
8km, Economic Development Zone, Kunming  
Area  
China (Yunnan) Pilot Free Trade Zone  
Kunming, Yunnan, 650500  
CHINA

### Agent

MILTONS IP/P.I.  
#200-15 Fitzgerald Road, Ottawa, ONTARIO,  
K2H9G1

## TRADEMARK DETAILS

### Trademark Type

Design

### Visual Representation



AIPETREE

### Goods

#### Class 26

artificial plants; Artificial flower wreaths; Artificial flowers; Artificial flowers of plastics; Artificial topiaries; Elastic ribbons; Artificial fruit; Embroidery; False hair; Slide fasteners and parts thereof; novelty buttons; Buttons for clothing; Hair bands; Laces for footwear; Needlepoint kits; Sewing kits; Slide fasteners and parts thereof; Zippers; spangles for clothing

**Application Number** 2,107,611  
**Language of Application** English

**Filing Date** 2021-05-17

## APPLICANT AND AGENT DETAILS

### Applicant

Kunming Mingming Electronic Commerce Co.  
Ltd.  
Room 208, Unit 4, Building 5  
No.40 Changhong Road, Wuhua District  
Kunming City, Yunnan Province, 650032  
CHINA

### Agent

MILTONS IP/P.I.  
#200-15 Fitzgerald Road, Ottawa, ONTARIO,  
K2H9G1

## TRADEMARK DETAILS

### Trademark Type

Design

### Visual Representation



### Foreign Character Translation

The mark "Baseca" has no meaning in English. It is a coined word.

### Goods

#### Class 20

Clips of plastic for sealing bags; pillows; dressing tables; Bed frames; Bookshelves; kitchen cabinets; Furniture cabinets; Camping mattresses; shoe racks; Cribs; Anti-roll cushions for babies; bath seats for babies; mattresses; Footstools; Folding shelves; Deck chairs; Folding beds; Hat stands; mirrors

**Application Number** 2,107,613  
**Language of Application** English

**Filing Date** 2021-05-17

## **APPLICANT DETAILS**

### **Applicant**

Quanzhou Souke Sports Co., Ltd.  
5th Floor, No.28, Xidong No.1 District  
Pengtianxinda Street, Lingxiu Town  
Shishi, Fujian, 362700  
CHINA

## **TRADEMARK DETAILS**

# **SOUKE SPORTS**

### **Trademark Type**

Standard Characters

### **Goods**

#### **Class 25**

sports clothing; trousers; pants; shorts; casual clothing; knit tops; sports jerseys; tee-shirts; wind coats; cyclists' clothing; bathing trunks; shoes; sports shoes; caps; hats; hosiery; gloves; ski gloves; scarves

**Application Number** 2,107,614  
**Language of Application** English

**Filing Date** 2021-05-17

## APPLICANT AND AGENT DETAILS

### Applicant

Kunming Zhanshuoxiang E-commerce Co., Ltd.  
No.1001, Unit 2, Building D08  
Shuxiang Dadi Community, Chenggong District  
Kunming City, Yunnan Province, 650500  
CHINA

### Agent

MILTONS IP/P.I.  
#200-15 Fitzgerald Road, Ottawa, ONTARIO,  
K2H9G1

## TRADEMARK DETAILS

### Trademark Type

Design

### Visual Representation



### Goods

#### Class 09

Webcams; camera lenses; 3D scanners; 3D spectacles; personal headphones for use with sound transmitting systems; Microphones; Cameras; Digital cameras; Tripods for cameras; Earphones; electronic burglar alarms; Meat thermometers; light switches; Electronic kitchen timers; food timers; scales with body mass analysers; kitchen weighing scales; Containers for contact lenses

**Application Number** 2,107,618  
**Language of Application** English

**Filing Date** 2021-05-17

## APPLICANT AND AGENT DETAILS

### Applicant

Beijing Zunxiang Time Technology Co., Ltd.  
(No. A1061, Jianwai Juying Union Incubator)  
14th Floor, Building 118, Jianguo Road  
Chaoyang District  
Beijing, 100020  
CHINA

### Agent

MILTONS IP/P.I.  
#200-15 Fitzgerald Road, Ottawa, ONTARIO,  
K2H9G1

## TRADEMARK DETAILS

### Trademark Type

Design

### Visual Representation

*Misabeau*

### Goods

#### Class 21

Back scratchers; Aquariums; soap dispensers; pot holders; Bento boxes; Boxes for dispensing paper towels; Cake moulds; Chopping boards for kitchen use; Chopstick cases; cleaning, dusting and polishing cloths; Cocktail shakers; Drinking glasses; Coffee cups; tea cups; mugs; beverage stirrers; Cookery moulds; Cooking pot sets; Containers for ice; Dinnerware; Drinking flasks



**Application Number** 2,107,621  
**Language of Application** English

**Filing Date** 2021-05-17

## APPLICANT AND AGENT DETAILS

### Applicant

Guangzhou Yuanhui Electronic Commerce Co., Ltd.  
Room 611, No. 9, Jieshun Road, Nancun Town Panyu District  
Guangzhou, Guangdong, 511442  
CHINA

### Agent

MILTONS IP/P.I.  
#200-15 Fitzgerald Road, Ottawa, ONTARIO, K2H9G1

## TRADEMARK DETAILS

### Trademark Type

Design

### Visual Representation



NURENDER

### Foreign Character Translation

The mark "Nurender" has no meaning in English. It is a coined word.

### Goods

#### Class 06

Bicycle locks; All-purpose metal straps; Aluminum foil paper; Andirons; Aviaries of metal; hose hangers of metal; Clothes hooks of metal; Barricades of metal; Bathtub grab bars of metal; Beverage cans of metal; Bolts of metal; Brackets of metal for furniture; Casement windows of metal; Safety cashboxes; Common metal bands for the identification of pet animals; drawer pulls of common metal; Containers of metal for stock feed; decking boards of metal; water-pipes of metal; non-electric metal door bells

**Application Number** 2,107,622  
**Language of Application** English

**Filing Date** 2021-05-17

## APPLICANT AND AGENT DETAILS

### Applicant

Kunming Zhanshuoxiang E-commerce Co., Ltd.  
No. 1001, Unit 2, Building D08  
Shuxiang Dadi Community, Chenggong District  
Kunming City, Yunnan Province, 650500  
CHINA

### Agent

MILTONS IP/P.I.  
#200-15 Fitzgerald Road, Ottawa, ONTARIO,  
K2H9G1

## TRADEMARK DETAILS

### Trademark Type

Design

### Visual Representation

The logo for Petiarkit features a stylized black triangle pointing to the right, followed by the word "Petiarkit" in a bold, lowercase, sans-serif font.

### Foreign Character Translation

The trademark "Petiarkit" has no meaning in English. It is a coined word.

### Goods

#### Class 28

Pet toys; Dog toys; Cat toys; Sand toys; Baby swings; Bags for skateboards; Dice; Fishing tackle; Inflatable pool toys; Inflatable pools for recreational use; Jigsaw puzzles; Jump ropes; Knee guards for athletic use; Shoulder pads for athletic use; Stuffed toy animals; Toy xylophones; Trampolines; yoga straps; yoga blocks; Board games

**Application Number** 2,107,650  
**Language of Application** English

**Filing Date** 2021-05-18

## APPLICANT AND AGENT DETAILS

### Applicant

Yuling Fu  
Room 406, Building B, Jinfeng Garden  
No. 652, Fengzhou Road, Fengzhou Town  
Nan'an City, Fujian Province,  
CHINA

### Agent

XIN XU  
(Fang An Law PC), Suite 300 & 306, 5500  
North Service Rd., Burlington, ONTARIO,  
L7L6W6

## TRADEMARK DETAILS

# SOBLUING

### Trademark Type

Standard Characters

### Goods

#### Class 20

furniture flower stands; flower-pot pedestals; bamboo curtains; industrial packaging containers of bamboo; bamboo baskets for industrial purposes; statues of plaster; wood carvings; wax figurines; plastic sculptures; cork furniture knobs; cork stoppers; resin figurines; signboards of wood or plastics; beds for household pets; kennels for household pets; dog kennels

**Application Number** 2,107,662  
**Language of Application** English

**Filing Date** 2021-05-18

## APPLICANT AND AGENT DETAILS

### Applicant

Yining Chen  
No.309, Nanzhuang, Jiulin Village Jieshan  
Town  
Quangang District  
Quanzhou,  
CHINA

### Agent

XIN XU  
(Fang An Law PC), Suite 300 & 306, 5500  
North Service Rd., Burlington, ONTARIO,  
L7L6W6

## TRADEMARK DETAILS

# SXXS

### Trademark Type

Standard Characters

### Goods

#### Class 24

Bedspreads; Brocades; Coverlets; Pillowcases; Quilts; Bath towels; Bed blankets; Bed covers; Bed covers of paper; Bed linen; Bed sheets; Cloth flags; Cotton cloth; Cotton fabrics; Curtain holders of textile material; Diaper changing cloths for babies; Esparto fabric; Fabric flags; Fabric valances; Fabrics for textile use; Face towels of textile; Face towels of textiles; Felt cloth; Felt and non-woven textile fabrics; Flax cloth; Fleece blankets; Furniture coverings made of plastic materials; Gauze fabric; Hand towels of textile; Handkerchiefs of textile; Hemp cloth; Labels of textile; Lingerie fabric; Mosquito nets; Non-woven textile fabrics; Nylon fabric; Paper bed covers; Pillow shams; Printed calico cloth; Printers' blankets of textile; Quilts of textile; Serviettes of textile; Silk fabrics for printing patterns; Sleeping bag liners; Table linen, namely, coasters; Table napkins of textile; Tablemats of textile; Textile handkerchiefs; Textile printers' blankets; Textile wall hangings; Towelling coverlets; Upholstery fabrics; Wash cloths; Woolen fabric; Woolen blankets; canvas for tapestry or embroidery; bed blankets made of wool; gauze fabric; indoor and outdoor curtains; decorative wall hangings of textile; face towels made of cotton; fabric boxes for storing greeting cards; contoured mattress covers; plastic table linens; serviettes of textile; heat-activated adhesive fabrics; woven fabrics

**Application Number** 2,107,663  
**Language of Application** English

**Filing Date** 2021-05-18

## APPLICANT AND AGENT DETAILS

### Applicant

Yining Chen  
No.309, Nanzhuang, Jiulin Village Jieshan  
Town  
Quangang District  
Quanzhou,  
CHINA

### Agent

XIN XU  
(Fang An Law PC), Suite 300 & 306, 5500  
North Service Rd., Burlington, ONTARIO,  
L7L6W6

## TRADEMARK DETAILS

# AFFA

### Trademark Type

Standard Characters

### Goods

#### Class 25

Bathing caps; Bathing suits; Dresses; Gloves; Masquerade costumes; Neckties; Overalls; Pajamas; Raincoats; Scarves; Smocks; Socks; Suspenders; Swimsuits; Tee-shirts; Underclothing; Underpants; Vests; Waistcoats; Wind coats; Underwear; baby pants; Girdles; strapless brassieres; shower caps; small hats; babies' underwear; baby layettes for clothing; casual clothing; sports jerseys; dress clothing; casual footwear; Caps; fleece tops; hooded jackets; muffler scarves; children's clothing; children's shirts; children's footwear; short pants; body stockings; turtleneck sweaters; short-sleeved t-shirts; infants' trousers

**Application Number** 2,107,665  
**Language of Application** English

**Filing Date** 2021-05-18

## APPLICANT AND AGENT DETAILS

### Applicant

Yining Chen  
No.309, Nanzhuang, Jiulin Village Jieshan  
Town  
Quangang District  
Quanzhou,  
CHINA

### Agent

XIN XU  
(Fang An Law PC), Suite 300 & 306, 5500  
North Service Rd., Burlington, ONTARIO,  
L7L6W6

## TRADEMARK DETAILS

# OBBO

### Trademark Type

Standard Characters

### Goods

#### Class 25

Bathing caps; Bathing suits; Dresses; Gloves; Masquerade costumes; Neckties; Overalls; Pajamas; Raincoats; Scarves; Smocks; Socks; Suspenders; Swimsuits; Tee-shirts; Underclothing; Underpants; Vests; Waistcoats; Wind coats; Underwear; baby pants; Girdles; strapless brassieres; shower caps; small hats; babies' underwear; baby layettes for clothing; casual clothing; sports jerseys; dress clothing; casual footwear; Caps; fleece tops; hooded jackets; muffler scarves; children's clothing; children's shirts; children's footwear; short pants; body stockings; turtleneck sweaters; short-sleeved t-shirts; infants' trousers

**Application Number** 2,107,680  
**Language of Application** English

**Filing Date** 2021-05-18

## APPLICANT AND AGENT DETAILS

### Applicant

Inner Mongolia Jiutianjia Catering Management Co., LTD  
No.9, D2 Zone, Yulong Industrial Park, Yuquan District, Hohhot  
Inner Mongolia Autonomous Region, 010000  
CHINA

### Agent

MILTONS IP/P.I.  
#200-15 Fitzgerald Road, Ottawa, ONTARIO,  
K2H9G1

## TRADEMARK DETAILS

### Trademark Type

Design

### Visual Representation

The image displays the Chinese characters '九田家' (Jiutianjia) in a large, bold, black, stylized font. The characters are written in a traditional calligraphic style with thick strokes and a slight slant. The character '九' (Jiu) is on the left, '田' (Tian) is in the middle, and '家' (Jia) is on the right. The overall appearance is clean and modern.

### Foreign Character Transliteration

The transliteration provided by the applicant of the foreign character(s) is JIUTIANJIA.

### Services

Class 43

agency services for booking hotel accommodation; bar services; boarding for animals; cafeteria services; café services; cake decorating; canteen services; catering of food and drinks; day-nursery services; personal chef services; providing campground facilities; rental and leasing of lighting apparatus and lighting systems for use in municipality lighting and public events; rental of chairs, tables, table linen, glassware; rental of drinking water dispensers; rental of kitchen worktops for preparing food for immediate consumption; restaurant services; retirement home services; snack-bar services; tourist hostel services; washoku restaurant services



**Application Number** 2,107,688  
**Language of Application** English

**Filing Date** 2021-05-18

## APPLICANT AND AGENT DETAILS

### Applicant

Jim Beam Brands Co.  
222 W. Merchandise Mart Plaza  
Suite 1600  
Chicago, IL 60654  
UNITED STATES OF AMERICA

### Agent

GOWLING WLG (CANADA) LLP  
SUITE 2600, 160 ELGIN STREET, OTTAWA,  
ONTARIO, K1P1C3

## TRADEMARK DETAILS

# BOTTLING THE BAR

### Trademark Type

Standard Characters

### Goods

#### Class 33

Alcoholic beverages, except beer, namely, whisky, gin, vodka, brandy, rum, cordials, liqueurs, spirits distilled from agave

### Claims

Priority Filing Date: November 18, 2020, Country or Office: UNITED STATES OF AMERICA, Application No: 90/328,129 in association with the same kind of goods

**Application Number** 2,107,720  
**Language of Application** English

**Filing Date** 2021-05-18

## APPLICANT AND AGENT DETAILS

### Applicant

Smith Enniskillen Company Limited  
39 McCrea Street  
P.O. Box 51  
Belgrave  
ONTARIO  
N0G1E0

### Agent

GOWLING WLG (CANADA) LLP  
1 MAIN STREET WEST, HAMILTON,  
ONTARIO, L8P4Z5

## TRADEMARK DETAILS

# SELSU

### Trademark Type

Standard Characters

### Goods

#### Class 05

Nutritional supplements for general health and well-being; Dietary supplements for general health and well-being.

**Application Number** 2,107,739  
**Language of Application** English

**Filing Date** 2021-05-18

## APPLICANT AND AGENT DETAILS

### Applicant

Calumet Refining, LLC  
A Delaware limited liability company  
2780 Waterfront Parkway East Dr  
Suite 200  
Indianapolis, IN 46214  
UNITED STATES OF AMERICA

### Agent

MARKS & CLERK  
33 Yonge Street, , Suite 300, Toronto,  
ONTARIO, M5E1G4

## TRADEMARK DETAILS

# CALTRAN

### Trademark Type

Standard Characters

### Goods

#### Class 17

insulating oil for transformers

**Application Number** 2,107,894  
**Language of Application** English

**Filing Date** 2021-05-18

## APPLICANT AND AGENT DETAILS

**Applicant**  
SHENZHEN FDC ELECTRONIC CO., LTD.  
East Zone, 4th Floor, Block E  
Huachuangda Industrial Park  
Gushu Hangcheng Avenue, Xixiang Street,  
Baoan District  
Shenzhen,  
CHINA

**Agent**  
MILTONS IP/P.I.  
#200-15 Fitzgerald Road, Ottawa, ONTARIO,  
K2H9G1

## TRADEMARK DETAILS

**Trademark Type**  
Design

**Visual Representation**



**Goods**

**Class 09**

earphones, motorcycle helmets, luminous signs, headphones, sports goggles, automatic indicators of low pressure in vehicle tires, global positioning system (GPS) receivers, car video recorders, ski helmets, selfie sticks for use with digital cameras.

**Application Number** 2,109,191  
**Language of Application** English

**Filing Date** 2021-05-25

## APPLICANT AND AGENT DETAILS

### Applicant

The Darling Beverage Company Ltd.  
119 Matilda St  
Clarksburg  
ONTARIO  
N0H1J0

### Agent

CHITIZ PATHAK LLP  
77 King Street West, TD North Tower, Suite  
700, P.O. Box 118, Toronto, ONTARIO,  
M5K1G8

## TRADEMARK DETAILS

# DARLING MIMOSA

### Trademark Type

Standard Characters

### Goods

#### Class 33

alcoholic fruit-based beverages; sparkling wine cocktails; wines, wine-based beverages and alcoholic wine-based beverages;

**Application Number** 2,109,339  
**Language of Application** English

**Filing Date** 2021-05-17

## APPLICANT AND AGENT DETAILS

### Applicant

2626725 Ontario Inc.  
381 Front Street, Suite 1003,  
Toronto,  
ONTARIO  
M5V3S8

### Agent

GARFINKLE BIDERMAN LLP  
Dundee Place, Suite 801, 1 Adelaide Street  
East, Toronto, ONTARIO, M5C2V9

## TRADEMARK DETAILS

# SexyB

**Trademark Type**  
Standard Characters

**Services**

**Class 43**

Restaurant services.

**Application Number** 2,109,501  
**Language of Application** French

**Filing Date** 2021-05-26

## APPLICANT DETAILS

### Applicant

Michèle Gervais  
8770 Duceppe  
H7A1R3  
Laval  
QUÉBEC  
H7A1R3

## TRADEMARK DETAILS

### Trademark Type

Design

### Visual Representation

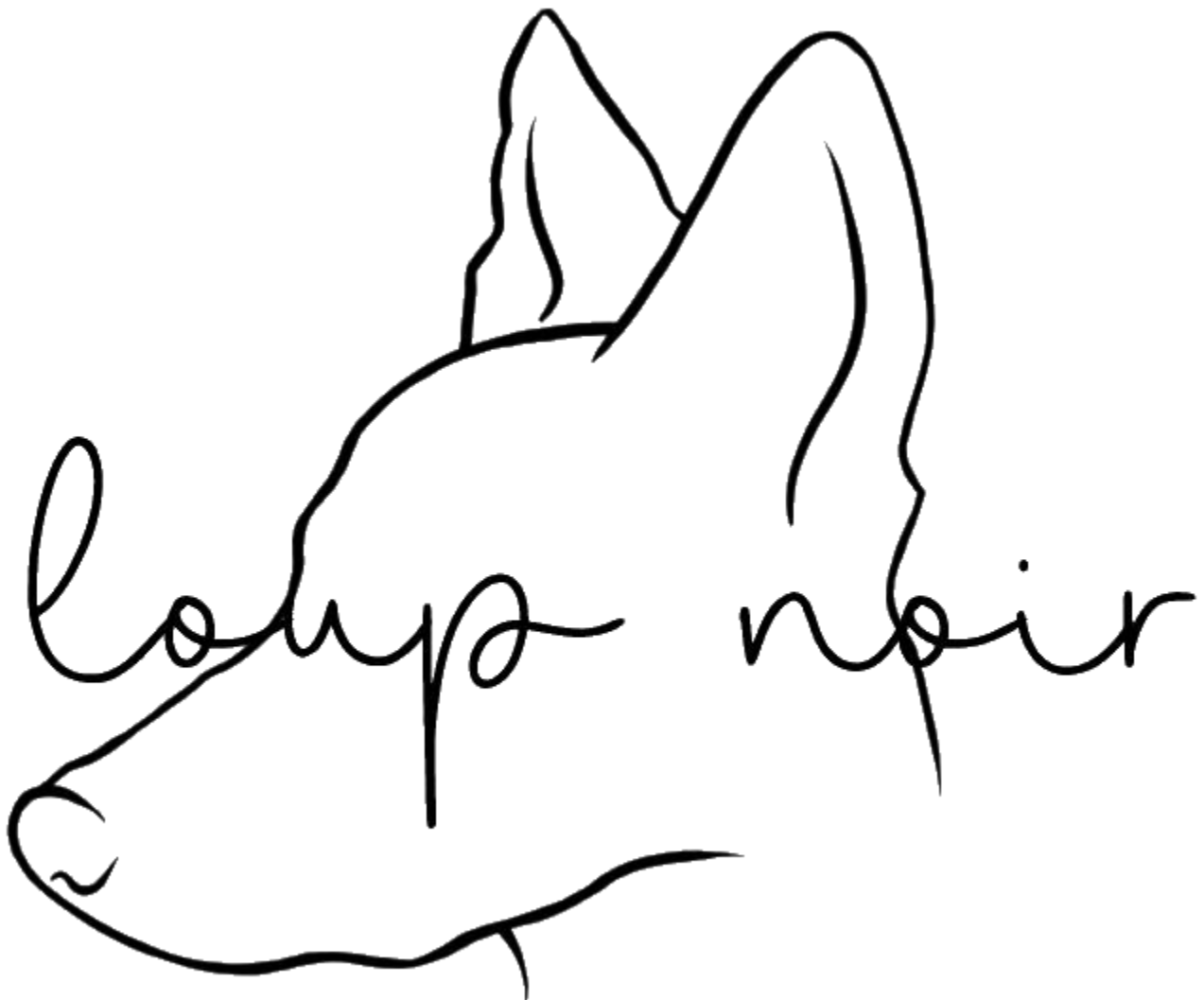

**Colour Claim**

Colour is claimed as a feature of the trademark. The outline of the dog's head, including the ears and the top of the neck, are black. The words LOUP NOIR are also black

**Goods****Class 18**

dog collars; dog collars and leads; leather leads; animal leashes; pet leashes; dog leashes



**Application Number** 2,109,504  
**Language of Application** English

**Filing Date** 2021-05-26

## APPLICANT AND AGENT DETAILS

### Applicant

Home Depot International, Inc.  
2455 Paces Ferry Road, NW  
Atlanta, GA 30339  
UNITED STATES OF AMERICA

### Agent

BERESKIN & PARR LLP/S.E.N.C.R.L., S.R.L.  
SCOTIA PLAZA, 40 KING STREET WEST,  
40th FLOOR, TORONTO, ONTARIO, M5H3Y2

## TRADEMARK DETAILS

# HAMPTON BAY

### Trademark Type

Standard Characters

### Goods

#### Class 11

LED candles

**Application Number** 2,109,754  
**International Registration Number** 1593767  
**Language of Application** English

**Filing Date** 2021-02-16

## APPLICANT AND AGENT DETAILS

### Applicant

EIGHT PAW PROJECTS LIMITED  
Greater London House,  
Hampstead Road  
London NW1 7FB  
UNITED KINGDOM

### Agent

FASKEN MARTINEAU DUMOULIN LLP  
Tour de la Bourse, Suite 3500, P.O. box 242,  
800, Place Victoria, Montréal, QUEBEC,  
H4Z1E9

## TRADEMARK DETAILS

### Trademark Type

Design

### Visual Representation

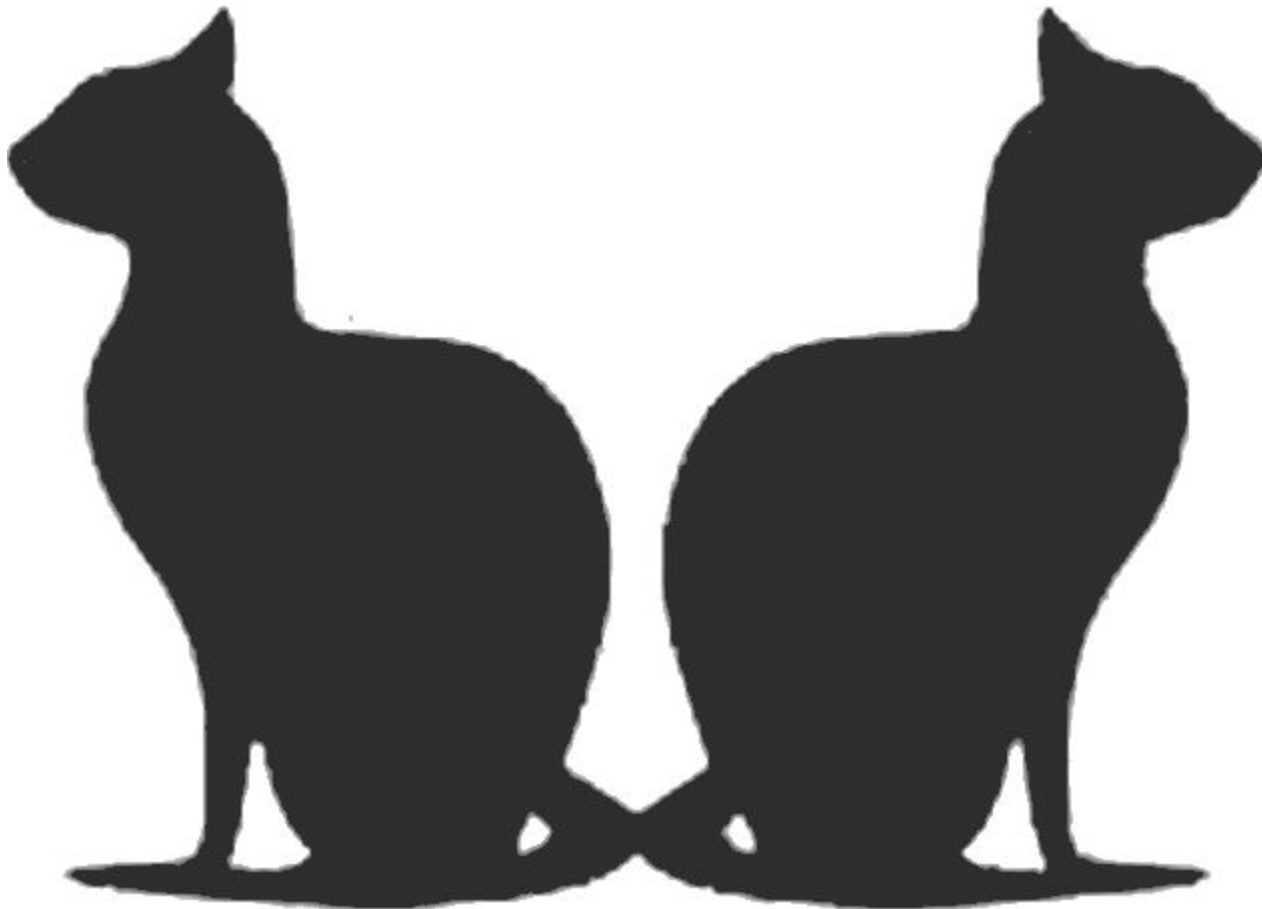

### Goods

#### Class 14

(1) Precious metals and their alloys; precious and semi-precious stones; jewellery; body jewellery; bangles; bracelets; articles of jewellery with ornamental stones; articles of jewellery with precious

and semi-precious stones; articles of imitation jewellery; brooches being jewellery; chains being jewellery; charms for jewellery; choker necklaces; earrings; necklaces; tie clips; tie pins; cufflinks; fashion jewellery; gemstones; decorative pins being jewellery; face jewellery; hat jewellery; head jewellery; foot jewellery; lapel pins; lockets being jewellery; medallions being jewellery; medals; necktie fasteners; rings being jewellery; scarf clips being jewellery; trinkets being jewellery; time instruments namely, clocks, watches, chronographs for use as watches, mechanical watches, pendant watches, pocket watches, dress watches, electric watches; watches incorporating a memory function namely, smartwatches; watches incorporating a telecommunication function, other than smartwatches; watches with GPS feature; watch bands; watch straps; jewellery boxes; watch boxes; boxes for cufflinks; boxes for tie pins; cases for watches and clocks; jewellery cases; key chains; key fobs made of common and precious metal and of leather; charms for key rings and key chains; key chains for use as jewellery; parts and fittings for the aforesaid goods.

### **Class 18**

(2) Leather and imitations of leather; luggage, wallets; all-purpose carrying bags; sports bags; athletic bags; bags made of leather; bags made of imitation leather; all-purpose carrying bags made of leather; all-purpose carrying bags made of imitation leather; backpacks; cosmetic bags sold empty; make-up bags sold empty; shaving bags sold empty; card wallets; pocket wallets; wallets for attachment to belts; purses; wrist-mounted purses; bum-bags; across-body bags; handbags; leather laces; umbrellas and parasols; walking sticks; hiking sticks; walking sticks incorporating seats; clothing for pets; parts and fittings for all the aforesaid goods.

### **Class 25**

(3) Sportswear; coats; jackets; dresses; hooded tops; sweatshirts; jeans; jumpers; cardigans; jumpsuits; playsuits; hosiery; lingerie; underwear; sports bras; nightwear; pyjamas; dressing gowns; sleep masks; loungewear; shorts; skirts; socks; tights; suits; swimwear; beachwear; tracksuits; trousers; dungarees; jogging pants; leggings; waistcoats; t-shirts; shirts; polo shirts; tunics; babies' bibs not of paper; vests; tank tops; blouses; bodices; bralettes; camisoles; corsets; capes; bikini tops; belts for clothing; suspender braces; wristbands; ear muffs; scarves; gloves; mittens; muffs; neckties; hats; caps; beanies; headbands; veils; bandanas; berets; shower caps; ear muffs; boots; sneakers; sandals; shoes; heeled shoes; flip flops; sliders; sports shoes; foot warming muffs; wristbands; parts and fittings for all the aforesaid goods.

### **Claims**

Priority Filing Date: September 01, 2020, Country or Office: LIECHTENSTEIN, Application No: 2020-640 in association with the same kind of goods

**Application Number** 2,109,756  
**International Registration Number** 1592849  
**Language of Application** English

**Filing Date** 2021-02-18

## APPLICANT DETAILS

### Applicant

Shanghai QiranBiological Technology Co., Ltd.  
Room 06, 11th Floor, Building 1,  
No.158 Shuanglian Road,  
Qingpu District  
201700 Shanghai  
CHINA

## TRADEMARK DETAILS

### Trademark Type

Design

### Visual Representation

**KIMTRUE**

### Goods

#### Class 03

Perfumes; aromatic essential oils; cosmetics; scented water; hair conditioners; shampoos; facial cleansing milk; bath foam; hair tonic; air fragrancing preparations.

**Application Number** 2,109,857  
**International Registration Number** 1593480  
**Language of Application** English

**Filing Date** 2021-03-24

## APPLICANT AND AGENT DETAILS

### Applicant

Pharma Cosmetics Laboratories Ltd.  
4 Nirim St.  
Tel Aviv  
ISRAEL

### Agent

WENDY D. RIEL  
(RIEL PROFESSIONAL CORPORATION), c/o  
MDK Business Law Professional Corporation,  
441 MacLaren Street, Suite 200B, Ottawa,  
ONTARIO, K2P2H3

## TRADEMARK DETAILS

# C THE SUCCESS

### Trademark Type

Standard Characters

### Goods

#### Class 03

Facial serums for cosmetic purposes; non-medicated facial cosmetic preparations, containing vitamin C

### Claims

Priority Filing Date: November 03, 2020, Country or Office: ISRAEL, Application No: 333056 in association with the same kind of goods

**Application Number** 2,109,978  
**International Registration Number** 1593543  
**Language of Application** English

**Filing Date** 2021-04-16

## APPLICANT AND AGENT DETAILS

### Applicant

Yoon Jee Na  
104Dong 103Ho, 21, Mallijae-ro 33-gil,  
Jung-gu  
Seoul  
REPUBLIC OF KOREA

### Agent

DEETH WILLIAMS WALL LLP  
150 YORK STREET, SUITE 400, TORONTO,  
ONTARIO, M5H3S5

## TRADEMARK DETAILS

### Trademark Type

Design

### Visual Representation



## Goods

### Class 14

(1) Women's jewelry; leather key chains; leather key holders; metal key rings; imitation leather key chains; imitation leather key holders; key chains of common metal; plastic key chains; plastic key holders; key fobs of imitation leather; bracelets of precious metal; earrings; necklaces; charms in precious metals or coated therewith; badges of precious metal; ornamental pins made of precious metal; jewelry brooches; ornaments of precious metal in the nature of jewelry.

### Class 18

(2) Hipsacks; golf umbrellas; leather bags and wallets; handbags for ladies; key bags; tote bags; carry-on bags; multi-purpose purses; leather and imitation leather bags; leather credit card cases; leather cases for keys; all-purpose athletic bags; business cases; garment carriers for suits, shirts and dresses; bags for sports; bags for sports clothing; luggage tags of leather; travelling cases of leather.

### Class 25

(3) Golf shoes; golf trousers; golf shirts; plus fours; golf skirts; golf caps; belts made of leather; belts [clothing]; belts made from imitation leather; trouser socks; sports socks; neck warmers; fur muffs; shoulder wraps [clothing]; shoulder scarves; stoles; ear muffs [clothing]; coats for women; coats for men; cardigans; sports jackets; clothing, namely, shirts and pants; knit bottoms; knit skirts; knit jackets; blazers; sleeveless jackets; scarves; sports vests; sports wear.

### Class 28

(4) Golf bags with or without wheels; divot repair tools [golf accessories]; golf bag tags; markers for golf balls; golf bags; golf gloves; golf equipment; fitted protective covers specially adapted for golf clubs; shaped covers for golf bags; golf bag straps; trolley bags for golf equipment; shaped covers for golf putters.

**Application Number** 2,110,504  
**Language of Application** English

**Filing Date** 2021-05-28

## **APPLICANT DETAILS**

**Applicant**  
SHEENWOO CORP.  
59 Delancey Cres  
Unionville  
ONTARIO  
L3P7E3

## **TRADEMARK DETAILS**

**Trademark Type**  
Design

**Visual Representation**





**Colour Claim**

Colour is claimed as a feature of the trademark. The mark consists of three semi circles and the wording "Oppi". The outermost semi-circle to the left is dark orange, the inner one is light orange and the outermost semi circle to the right is dark orange. The wording is dark orange.

**Services****Class 36**

point of sale service

**Application Number** 2,110,572  
**Language of Application** English

**Filing Date** 2021-05-31

## APPLICANT AND AGENT DETAILS

### Applicant

DongGuan Sogoode Computer System Co., Ltd  
Room 2001-2007, Building 16, No. 7, Keji 10th  
Road, Songshan Lake Park  
Dongguan City, Guangdong Province, 523000  
CHINA

### Agent

MILTONS IP/P.I.  
#200-15 Fitzgerald Road, Ottawa, ONTARIO,  
K2H9G1

## TRADEMARK DETAILS

# VOSFEEL

### Trademark Type

Standard Characters

### Goods

#### Class 07

brushes for vacuum cleaners; central vacuum cleaning installations; dust collecting machines for chemical processing; dust filters and bags for vacuum cleaners; electric carpet sweeper; floor cleaning machines; high pressure washers; steam cleaning machines; vacuum cleaners; washing machines

**Application Number** 2,111,202  
**Language of Application** English

**Filing Date** 2021-06-02

## APPLICANT DETAILS

### Applicant

Mathew Daniels  
69 1/2, London Rd  
77  
Thamesville  
ONTARIO  
N0P2K0

## TRADEMARK DETAILS

**Trademark Type**

Design

**Visual Representation**





**Goods**

**Class 31**

catnip; edible treats for cats and dogs; edible treats for pets

**Application Number** 2,111,204  
**Language of Application** English

**Filing Date** 2021-06-02

## APPLICANT DETAILS

### Applicant

cFortySix Solutions Ltd.  
101 Gamble Lane  
N0B2K0  
Rockwood  
ONTARIO  
N0B2K0

## TRADEMARK DETAILS

# Trailhead Botanicals

### Trademark Type

Standard Characters

### Goods

#### Class 03

(1) cannabidiol (CBD) derived from hemp for cosmetic purposes; cannabis oil for cosmetic purposes; colognes, perfumes and cosmetics; cosmetics

#### Class 05

(2) disinfectant soap; disinfectant soaps; disinfecting perfumed soaps

### Services

#### Class 35

catalogue shopping services in the field of cosmetics; computerized on-line ordering services in the field of cosmetics; distributorships in the field of cosmetics; door to door selling of cosmetics; mail order services in the field of cosmetics; marketing research in the fields of cosmetics, perfumery and beauty products; online sales of cosmetics; providing home shopping services of cosmetics by means of television; retail sale of cosmetics; wholesale sales of cosmetics

**Application Number** 2,111,375  
**International Registration Number** 1595050  
**Language of Application** English

**Filing Date** 2021-02-26

## APPLICANT AND AGENT DETAILS

### Applicant

Taorad GmbH  
Forckenbeckstraße 6  
52074 Aachen  
GERMANY

### Agent

JONATHAN COLOMBO  
(Marks & Clerk Law LLP), 100 Simcoe Street,  
Suite 200, Toronto, ONTARIO, M5H3G2

## TRADEMARK DETAILS

# TAORAD

### Trademark Type

Standard Characters

### Goods

#### Class 07

(1) Industrial robots, in particular robots for loading microscopy samples

#### Class 09

(2) Microscopes and parts therefor, namely tripods, lenses, microscope slides, reflectors, video processors, prisms, lenses, tubes, PLC-controlled cross and linear tables, camera chips, heat sinks; lights, LED lights, computer hardware for lighting control and electronic ballasts for LED lights and lighting fixtures, all for microscopes; computer software and hardware for image processing and evaluation; data containers, namely computer software and hardware for storing large amounts of data; downloadable software, in particular downloadable application software for image analysis, image annotation and reporting for processing digital images, user interfaces in the nature of image acquisition, data acquisition strategy, image processing, sample storage handling, data storage handling, and development environments in the nature of image processing, automatic and semi-automatic image annotation, image acquisition strategy development; downloadable mobile application software for image analysis, image annotation and reporting for processing digital images for use in tissue-imaging including brain imaging; electronic publications, namely reports manuals, booklets, books, magazines, brochures, handbooks, newsletters, pamphlets, 3D-Brain-Atlases; apparatus for scientific research, for laboratories, for diagnostics and histology, namely apparatus for cutting and manufacturing microscopic specimens

### Services

#### Class 42

Scientific and industrial research in the field of microscopy and for processing clinical research data for use in the field of tissue-imaging including brain imaging; preparation of technical reports, technological consultancy and preparation of reports relating to technological research, all in the field of microscopy and processing of clinical research data for use in the field of tissue-imaging including brain imaging; cloud hosting provider services, software as a service (SaaS) services featuring software for use in database management, for automated image recalculation, manual and automated image annotation, preparation of reports, all related to the field of microscopy and

processing of clinical research data for use in the field of tissue-imaging including brain imaging and rental of software; design, development and programming of software and mobile applications [apps]; installation, maintenance and repair of software and mobile applications [apps]; platform as a service (PaaS) featuring computer software platforms for use in database management for automated image recalculation, manual and automated image annotation, preparation of reports, all related to the field of microscopy and processing of clinical research data for use in the field of tissue-imaging including brain imaging

**Claims**

Priority Filing Date: August 31, 2020, Country or Office: GERMANY, Application No: 30 2020 111 942 in association with the same kind of goods and in association with the same kind of services

**Application Number** 2,111,399  
**International Registration Number** 1595135  
**Language of Application** English

**Filing Date** 2021-03-10

## APPLICANT AND AGENT DETAILS

### Applicant

Styling Services N.Z. Limited  
28 Victoria Crescent  
Abbotsford VIC 3067  
AUSTRALIA

### Agent

GOWLING WLG (CANADA) LLP  
SUITE 1600, 1 FIRST CANADIAN PLACE, 100  
KING STREET WEST, TORONTO, ONTARIO,  
M5X1G5

## TRADEMARK DETAILS

# KUMFS

### Trademark Type

Standard Characters

### Goods

#### Class 25

Clothing, namely shirts, t-shirts, tank tops, shorts, skirts, pants, jeans, jackets, pullovers, sweatshirts, jumpers, dresses, loungewear, swimwear, beachwear, belts, gloves, socks, scarves, footwear, namely boots, shoes, sneakers, sandals, flip-flops and slippers, headwear, namely hats, caps, beanies

### Services

#### Class 35

Retail and wholesale services in relation to carry bags, hand bags, purses, luggage, umbrellas, trunks and travelling bags, clothing, scarves, footwear, namely boots, shoes, sneakers, sandals, flip-flops and slippers, headwear, preparations for the care of footwear, shoe storage racks and containers; advisory services relating to business management and business operations; advertising consultancy



**Application Number** 2,111,408  
**International Registration Number** 1594644  
**Language of Application** English

**Filing Date** 2021-03-11

## APPLICANT AND AGENT DETAILS

### Applicant

OneD Material, Inc.  
2625 Hanover Street  
Palo Alto CA 94304  
UNITED STATES OF AMERICA

### Agent

ROBIC  
630, boul. René-Lévesque Ouest, 20e étage,  
Montréal, QUEBEC, H3B1S6

## TRADEMARK DETAILS

# SiNANode

### Trademark Type

Standard Characters

### Services

#### Class 40

(1) Consulting in the field of manufacturing of electrodes, batteries, anodes, fuel cells, capacitors, supercapacitors, ultracapacitors, battery systems, power systems, energy storage apparatus and instruments, energy conversion apparatus and instruments; Technical consulting in the field of manufacturing of silicon-graphite anode material; Manufacturing process consulting in the fields of electrodes, batteries, anodes, fuel cells, capacitors, supercapacitors, ultracapacitors, battery systems, power systems, energy storage apparatus and instruments, energy conversion apparatus and instruments, silicon-graphite anode material; Manufacture for others silicon-graphite anode material

#### Class 42

(2) Product development consultation; research and development and consultation related thereto in the field of batteries, anodes, fuel cells, capacitors, supercapacitors, ultracapacitors, battery systems, power systems, energy storage apparatus and instruments, and energy conversion apparatus and instruments

### Claims

Priority Filing Date: February 05, 2021, Country or Office: UNITED STATES OF AMERICA, Application No: 90514466 in association with the same kind of services

**Application Number** 2,111,433  
**International Registration Number** 1594412  
**Language of Application** English

**Filing Date** 2021-03-16

## APPLICANT AND AGENT DETAILS

### Applicant

NorLense AS  
Fiskebøl  
N-8317 Strønstad  
NORWAY

### Agent

MILLER IP LAW  
84 Neilson Drive, Toronto, ONTARIO, M9C1V7

## TRADEMARK DETAILS

### Trademark Type

Design

### Visual Representation



### Colour Claim

Colour is claimed as a feature of the trademark. The word NorLense and the outline of a droplet both appear in the colour orange.

### Foreign Character Translation

The translation provided by the applicant of the Norwegian word LENSE is BOOM.

### Goods

#### Class 01

(1) Synthetic chemicals for absorbing oil.

#### Class 17

(2) Oil protection equipment, namely oil fences and absorbent pads made of synthetic fabric, for the containment and recovery of oil spill and oil-based chemicals, and floating barriers for the containment of pollution.

#### Class 22

(3) Tents.

**Services**

**Class 37**

(1) Repair and installation of oil spill emergency equipment.

**Class 40**

(2) Production of oil spill emergency equipment.

**Application Number** 2,111,598  
**International Registration Number** 1593876  
**Language of Application** English

**Filing Date** 2021-04-08

## APPLICANT AND AGENT DETAILS

### Applicant

Right Hand Music Group, LLC  
3645 Marketplace Blvd., Suite 130-318  
East Point GA 30344  
UNITED STATES OF AMERICA

### Agent

GOWLING WLG (CANADA) LLP  
SUITE 2600, 160 ELGIN STREET, OTTAWA,  
ONTARIO, K1P1C3

## TRADEMARK DETAILS

# RIGHT HAND MUSIC GROUP

### Trademark Type

Standard Characters

### Disclaimer

The right to the exclusive use of the word "MUSIC GROUP" is disclaimed apart from the trademark.

### Goods

#### Class 09

Musical sound recordings in the form of pre-recorded CDs and downloadable digital audio recordings; downloadable musical sound recordings; pre-recorded CDs and vinyl records featuring music; musical video recordings, namely pre-recorded DVDs featuring music videos, live musical performances and musical concerts; downloadable music video recordings featuring music and musical entertainment; audiovisual recordings featuring music and musical entertainment performances in the form of pre-recorded DVDs and CDs; downloadable audiovisual recordings featuring music and musical entertainment; motion picture films about music and musical entertainment.

### Claims

Priority Filing Date: October 22, 2020, Country or Office: UNITED STATES OF AMERICA, Application No: 90271606 in association with the same kind of goods

**Application Number** 2,111,669  
**International Registration Number** 1522157  
**Language of Application** English

**Filing Date** 2021-04-26

## APPLICANT AND AGENT DETAILS

### Applicant

Obschestvo s ogranichennoj otvetstvennostyu"  
Nauchno-proizvodstvennoeob'edinenie  
BIOMICROGEL"  
ul. Konstruktorov, d. 5, of. 431  
RU-620010 Ekaterinburg  
RUSSIAN FEDERATION

### Agent

NEOMARK LTD.  
7450 rue Saint-Hubert, Montréal, QUEBEC,  
H2R2N3

## TRADEMARK DETAILS

# SPILLTEX

### Trademark Type

Standard Characters

### Trademark Description

Verbal designation "SPILLTEX"; The word is represented by the letters of the Latin alphabet in standard font.

### Goods

#### Class 01

(1) Filtering materials of vegetable substances for use in neutralization of spills and spill sites; filtering materials of organic mineral substance for use in neutralization of spills and spill sites; filtering materials of chemical preparation substances for absorbing spills; filtering materials of unprocessed plastics in combating spills; flocculants; water-purifying chemicals; oil-purifying chemicals; textile-impregnating chemicals; chemical additives for use as binding agents for petroleum products; ceramic materials in particulate form, for use as filtering media for use in decontamination of spills and spill sites

#### Class 24

(2) Filtering materials of textile, namely, filter cloth

**Application Number** 2,111,810  
**Language of Application** English

**Filing Date** 2021-06-03

## **APPLICANT DETAILS**

### **Applicant**

Glimpse Glass Inc.  
299 Discovery Ridge Blvd SW  
Calgary  
ALBERTA  
T3H5L7

## **TRADEMARK DETAILS**

# **Glimpse Glass**

### **Trademark Type**

Standard Characters

### **Disclaimer**

The right to the exclusive use of the words Glimpse, Glass is disclaimed apart from the trademark.

### **Services**

#### **Class 35**

sale of stained glass art and supplies;

**Application Number** 2,112,110  
**Language of Application** English

**Filing Date** 2021-06-04

## APPLICANT AND AGENT DETAILS

### Applicant

CAN Technologies, Inc.  
15407 McGinty Road West  
Wayzata, MN 55391  
UNITED STATES OF AMERICA

### Agent

BERESKIN & PARR LLP/S.E.N.C.R.L., S.R.L.  
SCOTIA PLAZA, 40 KING STREET WEST,  
40th FLOOR, TORONTO, ONTARIO, M5H3Y2

## TRADEMARK DETAILS

# TRUEQUINE

### Trademark Type

Standard Characters

### Goods

#### Class 05

- (1) animal feed supplements
- (2) animal feed additives; nutritional supplements for animal foodstuffs

### Claims

Priority Filing Date: January 12, 2021, Country or Office: UNITED STATES OF AMERICA,  
Application No: 90461407 in association with the same kind of goods (1)

**Application Number** 2,112,156  
**Language of Application** English

**Filing Date** 2021-06-04

## APPLICANT DETAILS

### Applicant

Morrell Pet Products International Inc.  
413294 Baseline Rd.  
R.R. 4  
P.O. Box 722  
Durham  
ONTARIO  
N0G1R0

## TRADEMARK DETAILS

### Trademark Type

Design

### Visual Representation



**GENESIS**  
U L T R A

### Goods

#### Class 31

(1) animal food pellets; canned cat food; canned dog food; cat food; dog food; edible cat treats; edible dog treats; edible horse treats; edible pet treats; edible treats for cats and dogs; edible treats for pets; food for hamsters; food for pets; food for rodents; hamster food; hay; pet food  
(2) rabbit food; rabbit treats; guinea pig food; guinea pig treats; hamster treats; gerbil food; gerbil treats; chinchilla food; chinchilla treats; hay for small animals;



**Application Number** 2,112,157  
**Language of Application** English

**Filing Date** 2021-06-04

## APPLICANT DETAILS

### Applicant

Morrell Pet Products International Inc.  
413294 Baseline Rd.  
R.R. 4  
P.O. Box 722  
Durham  
ONTARIO  
N0G1R0

## TRADEMARK DETAILS

# Genesis Ultra

### Trademark Type

Standard Characters

### Goods

#### Class 31

(1) animal food pellets; canned cat food; canned dog food; cat food; dog food; edible cat treats; edible dog treats; edible horse treats; edible pet treats; edible treats for cats and dogs; edible treats for pets; food for hamsters; food for pets; food for rodents; hamster food; hay; pet food  
(2) rabbit food; rabbit treats; guinea pig food; guinea pig treats; hamster treats; gerbil food; gerbil treats; chinchilla food; chinchilla treats; hay for small animals;

**Application Number** 2,112,366  
**Language of Application** English

**Filing Date** 2021-06-07

## APPLICANT AND AGENT DETAILS

### Applicant

The Ddrops Company Inc.  
126 Trowers Road  
Woodbridge  
ONTARIO  
L4L5Z4

### Agent

GOWLING WLG (CANADA) LLP  
SUITE 1600, 1 FIRST CANADIAN PLACE, 100  
KING STREET WEST, TORONTO, ONTARIO,  
M5X1G5

## TRADEMARK DETAILS

### Trademark Type

Design

### Visual Representation

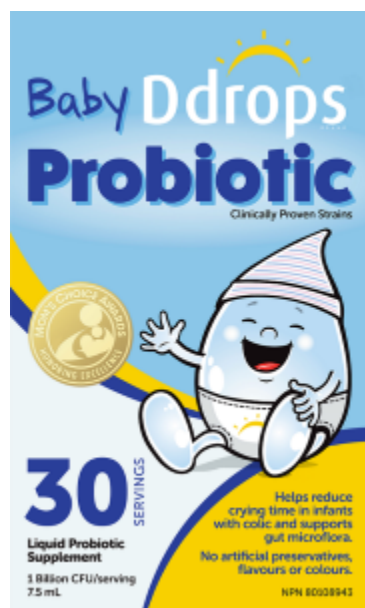

### Colour Claim

Colour is claimed as a feature of the trademark. The applicant claims the colours yellow, white, blue, very light blue, light blue, light brown, tan, red, pink, and black as a feature of the trademark. The words LIQUID PROBIOTIC SUPPLEMENT and CLINICALLY PROVEN STRAINS, 1 BILLION CFU/serving, 7.5ml, and NPN 80108943 appear in black. The words BRAND and DDROPS appears in white. The words BABY PROBIOTIC appear in blue. The Sun Design appears in yellow. The bottom right side of the packaging appears in yellow with a blue slim border. The bottom left side of the packaging appears in very light blue. The words HELPS REDUCE CRYING TIME IN INFANTS WITH COLIC AND SUPPORTS GUT MICROFLORA, NO ARTIFICIAL PRESERVATIVES, FLAVOURS OR COLOURS, 30 SERVINGS appear in blue. The Character appears in light blue with black eyes. His hat is pink, white and light blue. His entire figure features a white border outlined in black. His cheeks and sides feature white circular highlights. His open mouth is black with a red tongue. His diaper is white, outlined by a black dotted line and features a

yellow sun design. The background behind the character is light blue. The slim arc shapes behind the character appear in yellow and blue. The circular logo appears in light brown with tan accents.

**Goods****Class 05**

Vitamins and nutritional supplements for general health and well-being

**Application Number** 2,112,453  
**Language of Application** English

**Filing Date** 2021-06-07

## **APPLICANT DETAILS**

### **Applicant**

Trend Motoring Accessories Ltd  
706-2071 Kingsway Ave  
Port Coquitlam  
BRITISH COLUMBIA  
V3C6N2

## **TRADEMARK DETAILS**

# **Wheel Rack**

### **Trademark Type**

Standard Characters

### **Services**

#### **Class 35**

online sales of automobile parts

**Application Number** 2,112,552  
**Language of Application** English

**Filing Date** 2021-06-08

## APPLICANT AND AGENT DETAILS

### Applicant

TCA ENTERPRISES LTD.  
166 Dumfries Ave  
Brampton  
ONTARIO  
L6Z2W5

### Agent

MARK W. TIMMIS  
(MARK TIMMIS LAW CORPORATION), 2595  
CAVENDISH AVENUE, VICTORIA, BRITISH  
COLUMBIA, V8R2G5

## TRADEMARK DETAILS

# PETIXIA

### Trademark Type

Standard Characters

### Goods

#### Class 21

non-mechanized pet waterers in the nature of portable water and fluid dispensers for pets; pet bowls

**Application Number** 2,112,869  
**Language of Application** English

**Filing Date** 2021-06-09

## APPLICANT AND AGENT DETAILS

### Applicant

Cordell & Cordell, P.C.  
600 Kellwood Parkway, Suite 300  
Chesterfield, MO 63017  
UNITED STATES OF AMERICA

### Agent

BORDEN LADNER GERVAIS LLP  
World Exchange Plaza, 100 Queen Street,  
Suite 1300, Ottawa, ONTARIO, K1P1J9

## TRADEMARK DETAILS

# A PARTNER MEN CAN COUNT ON

### Trademark Type

Standard Characters

### Services

#### Class 45

legal services

**Application Number** 2,112,870  
**Language of Application** English

**Filing Date** 2021-06-09

## **APPLICANT AND AGENT DETAILS**

### **Applicant**

Cordell & Cordell, P.C.  
600 Kellwood Parkway, Suite 300  
Chesterfield, MO 63017  
UNITED STATES OF AMERICA

### **Agent**

BORDEN LADNER GERVAIS LLP  
World Exchange Plaza, 100 Queen Street,  
Suite 1300, Ottawa, ONTARIO, K1P1J9

## **TRADEMARK DETAILS**

# **CORDELL & CORDELL**

### **Trademark Type**

Standard Characters

### **Services**

#### **Class 45**

legal services

**Application Number** 2,113,114  
**International Registration Number** 1595906  
**Language of Application** English

**Filing Date** 2021-03-16

## APPLICANT AND AGENT DETAILS

### Applicant

Early Morning Studio AB  
Rallarrosvägen 7D,  
C/O Emir Kuljanin  
SE-806 47 Gävle  
SWEDEN

### Agent

ANITA MAR  
dba Trademark Angel, Suite 521, 6-2557  
Dougall Avenue, Windsor, ONTARIO, N8X1T5

## TRADEMARK DETAILS

# Early Morning Studio

### Trademark Type

Standard Characters

### Goods

#### Class 09

Computer game software; video game programs; downloadable software in the nature of a mobile application for playing games, namely, for playing role-playing games for Mobile, PC and Console; computer hardware.

### Services

#### Class 41

Entertainment services provided via on-line computer games, interactive computer and video games, arranging of online gaming; organising of games and competitions, namely, role-playing games for Mobile, PC and Console, and video game competitions; animation production services; special effects animation services for film and video.

### Claims

Priority Filing Date: March 16, 2021, Country or Office: UNITED KINGDOM, Application No: UK00003611118 in association with the same kind of goods and in association with the same kind of services



**Application Number** 2,113,193  
**International Registration Number** 1595277  
**Language of Application** English

**Filing Date** 2021-04-07

## APPLICANT AND AGENT DETAILS

### Applicant

PIAGGIO & C. S.P.A.  
VIALE RINALDO PIAGGIO 25  
I-56025 PONTEDERA, PISA  
ITALY

### Agent

ROBIC  
630, boul. René-Lévesque Ouest, 20e étage,  
Montréal, QUEBEC, H3B1S6

## TRADEMARK DETAILS

### Trademark Type

Design

### Visual Representation



### Foreign Character Translation

The translation provided by the applicant of the Italian word MOTO is MOTORCYCLE.

### Goods

#### Class 12

Two, three, four-wheeled vehicles, namely, motor scooters, motorcycles, mopeds, motorized bicycles, motorized tricycles, vans, automobiles and trucks; electrically powered scooters; electric push scooters [vehicles]; bodies for vehicles; brakes for land vehicles; caps for land vehicle gas tanks; luggage nets for vehicles; seat covers for vehicles; shock absorbing springs for vehicles; suspension shock absorbers for vehicles; vehicle chassis; vehicle seats; pneumatic tires; casings for pneumatic tires; non-skid devices for vehicle tires; adhesive rubber patches for repairing inner tubes; air pumps for bicycles and motorcycles; repair outfits for inner tubes, namely, tire repair patches; rims for vehicle wheels; valves for vehicle tires; air bags in the nature of safety devices for automobiles; electric cigarette lighters for land vehicles; anti-theft devices for vehicles, namely, anti-theft devices for motor cars, anti-theft automotive alarm, anti-theft warning apparatus for motor cars, anti-theft locks for use on automobile steering wheels, electrical anti-theft installations for vehicles; antitheft alarms for vehicles; horns for vehicles; safety seats for children, for vehicles; bells for cycles; stands for bicycles and motorcycles as parts of bicycles and motorcycles;

mudguards; direction signals for vehicles; frames for bicycles and motorcycles; luggage carriers for vehicles; pedals for bicycles and motorcycles; rearview mirrors; saddle covers for bicycles and motorcycles; saddlebags adapted for bicycles and motorcycles; saddles for bicycles and motorcycles; engines for land vehicles; electric motors for land vehicles; bags specially adapted for motorcycles, namely tank bags, sissy bar bags, tail bags, side hardbags, top cases.

**Claims**

Priority Filing Date: April 01, 2021, Country or Office: ITALY, Application No: 302021000059894 in association with the same kind of goods

**Application Number** 2,114,501  
**International Registration Number** 1597348  
**Language of Application** English

**Filing Date** 2021-01-09

## APPLICANT AND AGENT DETAILS

### Applicant

Menther, LLC  
360 State Street #1901  
New Haven CT 06510  
UNITED STATES OF AMERICA

### Agent

MARK W. TIMMIS  
(MARK TIMMIS LAW CORPORATION), 2595  
CAVENDISH AVENUE, VICTORIA, BRITISH  
COLUMBIA, V8R2G5

## TRADEMARK DETAILS

# MENTHER

### Trademark Type

Standard Characters

### Goods

#### Class 09

Downloadable computer software for use in searching and matching of mentors with mentees; downloadable computer software for synchronous and asynchronous communication consisting of messaging, instant messaging, texting, emailing, editing, commenting, calling, video calling, and video conferencing between mentors and mentees; downloadable computer software for tracking mentorship progress and facilitating synchronous and asynchronous communication between mentors and mentees consisting of messaging, instant messaging, texting, emailing, editing, commenting, calling, video calling, and video conferencing

### Services

#### Class 42

Providing on-line non-downloadable computer software for connecting mentors and mentees, tracking mentorship progress and facilitating synchronous and asynchronous communication consisting of messaging, instant messaging, texting, emailing, editing, commenting, calling, video calling, and video conferencing between mentors and mentees for community building; providing on-line non-downloadable computer software for matching, searching and scheduling for mentors and mentees; computer services, namely, creating an on-line community for registered users to engage in social networking and discuss topics in a virtual community for mentors and mentees for community building

### Claims

Priority Filing Date: July 16, 2020, Country or Office: UNITED STATES OF AMERICA, Application No: 90056384 in association with the same kind of goods and in association with the same kind of services

**Application Number** 2,114,796  
**International Registration Number** 1596737  
**Language of Application** English

**Filing Date** 2021-04-20

## APPLICANT AND AGENT DETAILS

### Applicant

Demand Science Group, LLC  
222 Rosewood Dr  
Danvers MA 01923  
UNITED STATES OF AMERICA

### Agent

WENDY D. RIEL  
(RIEL PROFESSIONAL CORPORATION), c/o  
MDK Business Law Professional Corporation,  
441 MacLaren Street, Suite 200B, Ottawa,  
ONTARIO, K2P2H3

## TRADEMARK DETAILS

# DEMAND SCIENCE

### Trademark Type

Standard Characters

### Services

#### Class 35

Marketing services for others, namely providing sales leads by identifying, activating and converting buyers; providing demand creation and lead generation in the area of sales.

**Application Number** 2,115,608  
**Language of Application** English

**Filing Date** 2021-06-21

## **APPLICANT DETAILS**

### **Applicant**

Mmm Canada Confections Inc  
168 wardlaw place  
L4H 3L6  
Vaughan  
ONTARIO  
L4H3L6

## **TRADEMARK DETAILS**

# **Mmm Canada**

### **Trademark Type**

Standard Characters

### **Disclaimer**

The right to the exclusive use of the word Canada is disclaimed apart from the trademark.

### **Goods**

#### **Class 30**

bittersweet chocolate; candy bars; chocolate; chocolate and chocolates; chocolate bars; chocolate candies; chocolate confectionery; chocolate confections; chocolate covered fruits; chocolate covered nuts; chocolate truffles; chocolate-coated nuts; chocolate-covered nuts; filled chocolate; filled chocolates; milk chocolate

**Application Number** 2,116,172  
**International Registration Number** 1598138  
**Language of Application** English

**Filing Date** 2020-12-22

## APPLICANT AND AGENT DETAILS

### Applicant

Metsola Lifestyle Oy  
Pulkkisentie 23  
FI-90440 KEMPELE  
FINLAND

### Agent

OSLER, HOSKIN & HARCOURT LLP  
SUITE 6200, P.O. BOX 50, 1 FIRST  
CANADIAN PLACE, TORONTO, ONTARIO,  
M5X1B8

## TRADEMARK DETAILS

# METSOLA

### Trademark Type

Standard Characters

### Goods

#### Class 03

(1) Substances for laundry use, namely bleaching preparations for laundry use, laundry detergents and laundry fabric softeners; laundry vinegar for use as fabric conditioning preparation; fabric softeners; non-medicated toiletries, namely shower gel, body soap, body wash, shaving soap, and shower cream; cosmetics; detergents for household use

#### Class 24

(2) Sheets [textile]; sleeping bags; baby sleep bag; textiles for clothes; oilcloth; bed covers; pillowcases, blanket covers and sheets for beds; table covers; bath linen; bed sheets and blankets; blankets; kitchen and table linens; coverings for furniture, namely slipcovers for furniture; curtains of textile or plastic; handkerchiefs of textile; bed and bath linens; mattress covers; shower curtains of textile or plastic; textile napkins; bath and beach towels; washing mitts; textile handkerchiefs; infants' bed linen; textile fabrics for making into clothing for babies and infants; towels for infants and babies; gauze fabric; baby comforter (cloth); baby comfort blanket

#### Class 25

(3) Clothing, namely shirts, pants, skirts, jackets; footwear, namely shoes, boots, slippers and sandals; headgear, namely hats, caps; gloves [clothing]; intermediate soles, namely footwear midsoles; belts [clothing]; scarves; baby bibs not of paper; socks; puttees; spats; shawls and headscarves; neck scarves [mufflers]; pocket squares; maternity clothing; dressing gowns

### Claims

Priority Filing Date: December 22, 2020, Country or Office: EUIPO (EU), Application No: 018362126 in association with the same kind of goods

Application Number 2,116,479  
International Registration Number 1597776  
Language of Application English

Filing Date 2021-04-22

## APPLICANT AND AGENT DETAILS

**Applicant**  
MONTENEGRO S.R.L.  
VIA ENRICO FERMI 4  
I-40069 ZOLA PREDOSA, BOLOGNA  
ITALY

**Agent**  
ROBIC  
630, boul. René-Lévesque Ouest, 20e étage,  
Montréal, QUEBEC, H3B1S6

## TRADEMARK DETAILS

Trademark Type  
Design

Visual Representation



# LONDON DRY GIN

**Colour Claim**

Colour is claimed as a feature of the trademark. The words EDGAR, DRY and GIN, as well as the drawing of the raven and the twigs in its beak are black. The words SOPPER and LONDON, as well as the raven's hat are red. The lines of the building are gray, while the building itself is white. The legs of the raven, as well as the texture of its plumage, its beak, its glasses, and the band on its hat are also white

**Goods****Class 33**

Gin.

**Claims**

Priority Filing Date: April 15, 2021, Country or Office: ITALY, Application No: 302021000068870 in association with the same kind of goods



**Application Number** 2,116,619  
**International Registration Number** 1412216  
**Language of Application** English

**Filing Date** 2021-05-26

## APPLICANT AND AGENT DETAILS

### Applicant

Scribbr B.V.  
Singel 542  
NL-1017 AZ Amsterdam  
NETHERLANDS

### Agent

TORYS LLP  
SUITE 3000, 79 WELLINGTON ST. W., BOX  
270, TD CENTRE, TORONTO, ONTARIO,  
M5K1N2

## TRADEMARK DETAILS

# SCRIBBR

### Trademark Type

Standard Characters

### Services

#### Class 35

(1) Commercial business management, business administration, administrative and secretarial services, public relations, writing commercial texts, including press releases, preparing business reports, news clipping services, word processing, business intermediary services in the nature of mediation and conclusion of commercial transactions for third parties, compiling statistics in a central file, administrative management of data files, informational and advisory services relating to all the aforesaid services, all the aforesaid services provided by both electronic means, including the internet, and non-electronic means

#### Class 41

(2) Education services, namely, tutorial sessions, workshops and feedback sessions in the nature of educational programs in the field of writing, proofreading and editing, education services, namely, coaching in the field of writing, grammar, language, referencing, citation styles, quantitative and qualitative research methods, word markup and layout, proofreading, editing and plagiarism, student education counseling services, namely, providing advice concerning thesis and dissertation subject choice, educational counseling services to assist students in planning and preparing for further education, providing advice concerning education options to pursue career opportunities, education services namely, thesis supervision in the nature of mentoring in the field of writing theses, arranging and conducting of training courses and workshops in the field of writing and grammar, language, referencing, proofreading and editing, citation styles, quantitative and qualitative research methods, word markup and layout, and plagiarism, organizing and arranging educational conferences, seminars, symposiums, conventions, exhibitions and lectures in the field of writing and grammar, proofreading and editing, language, referencing, citation styles, quantitative and qualitative research methods, word markup and layout, and plagiarism, publication, lending and publishing of newsletters, books, newspapers, magazines, brochures, leaflets, printed matter and other writings and publications, writing of texts for others, other than advertising texts, including for educational applications, namely, poem writing, songwriting, speech writing, essay writing, thesis writing, dissertation writing, writing of texts, other than commercial texts, namely, poem writing, songwriting, speech writing, essay writing, thesis writing, dissertation

writing, and proofreading of manuscripts, publishing services namely, copy editing written texts, and publishing and proofreading books, brochures, newsletters, magazines, electronic publications, theses, graduation projects, PhD dissertations, essays, admissions essays, application essays, personal statements, reports, process reports, reflections, internship reports, academic papers, interviews, proposals, research proposals, prospectuses and scientific papers, translation services, providing online non-downloadable electronic publications namely, books, brochures, newsletters, magazines, electronic articles, theses, graduation projects, PhD dissertations, essays, admissions essays, application essays, personal statements, reports, process reports, reflections, internship reports, academic papers, interviews, proposals, research proposals, prospectuses and scientific papers in the field of writing and grammar, language, referencing, proofreading and editing, citation styles, quantitative and qualitative research methods, word markup and layout and plagiarism, organizing educational events and demonstrations, namely fairs, and exhibitions in the field of writing and grammar, language, proofreading and editing, referencing, citation styles, quantitative and qualitative research methods, word markup and layout and plagiarism, informational and advisory services relating to all the aforesaid services, all the aforesaid services provided by both electronic means, including the internet, and non-electronic means.

#### **Class 42**

(3) Scientific and technological services namely, research and design of new products for others, designing and developing computers and software, installation, maintenance, updating and upgrading of computer software, server administration, hosting databases, servers and websites, computer system analysis, information technology [IT] consultancy services relating to computer programming, design of computer systems and websites, rental of computer software, computers and web servers, informational and advisory services relating to all the aforesaid services, all the aforesaid services provided by both electronic means, including the internet, and non-electronic means

**Application Number** 2,116,944  
**Language of Application** English

**Filing Date** 2021-06-25

## **APPLICANT AND AGENT DETAILS**

### **Applicant**

Albaugh, LLC  
1525 NE 36th Street  
Ankeny, IA 50021  
UNITED STATES OF AMERICA

### **Agent**

SMART & BIGGAR LP  
1100-150 York street, TORONTO, ONTARIO,  
M5H3S5

## **TRADEMARK DETAILS**

# **FOREFRONT**

### **Trademark Type**

Standard Characters

### **Goods**

#### **Class 05**

herbicides, fungicides, pesticides, insecticides

**Application Number** 2,117,133  
**Language of Application** English

**Filing Date** 2021-06-28

## **APPLICANT AND AGENT DETAILS**

### **Applicant**

Home Depot International, Inc.  
2455 Paces Ferry Road, NW  
Atlanta, GA 30339  
UNITED STATES OF AMERICA

### **Agent**

BERESKIN & PARR LLP/S.E.N.C.R.L., S.R.L.  
SCOTIA PLAZA, 40 KING STREET WEST,  
40th FLOOR, TORONTO, ONTARIO, M5H3Y2

## **TRADEMARK DETAILS**

# **HAMPTON BAY**

### **Trademark Type**

Standard Characters

### **Goods**

#### **Class 04**

mineral oil

**Application Number** 2,117,144  
**Language of Application** English

**Filing Date** 2021-06-28

## APPLICANT AND AGENT DETAILS

### Applicant

Hydrofuel Canada Inc.  
1048 Springwater Cres  
Mississauga  
ONTARIO  
L5V1G4

### Agent

BLANEY MCMURTRY LLP  
Suite 1500, 2 Queen Street East, Toronto,  
ONTARIO, M5C3G5

## TRADEMARK DETAILS

### Trademark Type

Design

### Visual Representation



The logo consists of the chemical formula  $N_2H_3$  positioned above the word "HYDROFUEL". The letters are rendered in a bold, metallic, 3D style with a dark grey base and lighter grey highlights, giving them a three-dimensional appearance. The "N" is positioned above the "H", and the "3" is positioned below the "H".

### Goods

#### Class 04

aviation fuel; biodiesel fuel; fuel gas; motor fuel; solidified gas for fuel

**Application Number** 2,118,306  
**International Registration Number** 1587966  
**Language of Application** French

**Filing Date** 2021-05-06

## APPLICANT AND AGENT DETAILS

### Applicant

Beeche  
113 rue Royale  
F-59800 LILLE  
FRANCE

### Agent

BERESKIN & PARR LLP/S.E.N.C.R.L., S.R.L.  
SCOTIA PLAZA, 40 KING STREET WEST,  
40th FLOOR, TORONTO, ONTARIO, M5H3Y2

## TRADEMARK DETAILS

# Bulles de ruche

### Trademark Type

Standard Characters

### Foreign Character Translation

Beehive Bubbles.

### Goods

#### Class 30

(1) Honey.

#### Class 32

(2) Beers; carbonated waters; lemonades; sodas; alcohol-free aperitifs.

#### Class 33

(3) Alcoholic beverages except beers, namely rum-based beverages, tequila-based beverages, alcoholic fruit drinks, cognac, whiskey; wines.

**Application Number** 2,118,724  
**Language of Application** English

**Filing Date** 2021-07-05

## APPLICANT AND AGENT DETAILS

### Applicant

Société des Produits Nestlé S.A.  
Avenue Nestlé 55  
Vevey, 1800  
SWITZERLAND

### Agent

EMMANUELLE PARÉ  
CP 161, Saint-Philippe BP, QUEBEC, J0L2K0

## TRADEMARK DETAILS

# VUNA

### Trademark Type

Standard Characters

### Goods

#### Class 29

(1) baba ganoush dips; baked potatoes; bean dips; bouillon; broth concentrates; canned meat spreads; caramelized onion dips; cheese dips; dehydrated potatoes; dried mushrooms; dried vegetables; edible oils and edible fats; fish jellies; fish preserves; fish spreads; fish substitutes; frozen vegetables; fruit salads; fruit-based dips; fruit-based spreads; garlic dips; herbs and spice dips; hummus; insect-based spreads; meat extracts; meat jellies; meat preserves; meat spreads; potatoes, preserved; pre-cooked stew; preparations for making bouillon; preparations for making soup; prepared meals consisting primarily of cooked vegetables; prepared meals consisting primarily of fruit; prepared meals consisting primarily of meat substitutes; prepared meals consisting primarily of potatoes; prepared meals consisting primarily of seafood; prepared meals consisting principally of fish; prepared meals consisting principally of meat; prepared meals consisting principally of poultry; preserved mushrooms; preserved vegetables; seafood spreads; seaweed extracts for food; seed-based meat substitutes; soup concentrates; soups; soy-based and pea-based meat substitutes; spinach dips; stock cubes; tofu dips; vegan and vegetarian meat substitutes; vegetable burger patties; vegetable salads; vegetable-based dips; vegetable-based spreads; vegetarian sausages;

#### Class 30

(2) bread; fish sauce; flour; flour-based dumplings; flour-based gnocchi; instant oatmeal; noodles; oat-based snack foods; oatmeal cookies; pasta; pasta sauce; pastry; pizza sauce; prepared meals consisting primarily of pasta; yeast;

**Application Number** 2,119,294  
**International Registration Number** 1601041  
**Language of Application** English

**Filing Date** 2021-04-13

## APPLICANT AND AGENT DETAILS

### Applicant

Summit Goal Food & Beverages Limited  
Commerce House, Suite 103,  
14 Washington Street  
Cork, Cork City  
T12NCF2  
IRELAND

### Agent

BERESKIN & PARR LLP/S.E.N.C.R.L., S.R.L.  
SCOTIA PLAZA, 40 KING STREET WEST,  
40th FLOOR, TORONTO, ONTARIO, M5H3Y2

## TRADEMARK DETAILS

# CODE WELL

### Trademark Type

Standard Characters

### Goods

#### Class 05

(1) Nutritional supplements namely anti-inflammatory nutritional supplements, beta carotene supplements, calcium supplements; dietetic foods for medical purposes namely dietetic food and substances adapted for medical use for the prevention and treatment of iron deficiency and anaemia in humans, dietetic sugar for medical purposes; dietary supplement drinks for medical purposes namely dietary supplement drink mixes for general health and well-being; foodstuffs for medical purposes namely mineral supplements for foodstuffs; food for babies and infants; dietetic preparations for children for medical purposes namely dietetic beverages for babies adapted for medical purposes

#### Class 30

(2) Coffee, tea, cocoa and artificial coffee; rice, tapioca and sago; flour and preparations made from cereals namely cereal-based bars, breakfast cereals, cereal-based snack food; bread, pastry and confectionery namely chocolate confectionery, butterscotch confectionery, confectionery fruit jellies, fruit confectionery, frozen confectionery; ices; honey, treacle; yeast, baking powder; salt; mustard; vinegar, sauces (condiments) namely barbecue sauce, béchamel sauce, apple sauce, cheese sauce, pasta sauce, salad sauces, soy sauce, tomato sauce, teriyaki sauce, taco sauce; spices; ice; sugar coated and chocolate coated nuts; tortilla snacks, cereal snacks, rice snacks, flour-based savory snacks, snack food made from corn, snack foods prepared from potato flour, snack food products made from maize flour namely crackers, biscuits, cookies, wafers; popcorn; candy

#### Class 32

(3) Non-alcoholic drinks namely non-alcoholic fruit drinks, non-alcoholic vegetable juice drinks, non-alcoholic cocktails, non-alcoholic cider, non-alcoholic beer; mineral and aerated waters; energy drinks; beers; aerated beverages namely aerated fruit juice; fruit beverages and fruit juices; syrups and other preparations for making beverages namely essences for making soft drinks, essences



for making non-alcoholic beverages, concentrates and powders used in the preparation of energy drinks and fruit-flavored drinks

**Claims**

Priority Filing Date: October 23, 2020, Country or Office: EUIPO (EU), Application No: 018325308  
in association with the same kind of goods

**Application Number** 2,119,416  
**International Registration Number** 1601319  
**Language of Application** English

**Filing Date** 2021-05-10

## APPLICANT AND AGENT DETAILS

### Applicant

Indie Hops, LLC  
2505 SE 11th Avenue, Suite 311  
Portland OR 97202  
UNITED STATES OF AMERICA

### Agent

GOWLING WLG (CANADA) LLP  
550 BARRARD STREET, SUITE 2300,  
VANCOUVER, BRITISH COLUMBIA, V6C2B5

## TRADEMARK DETAILS

# LÓRIEN

### Trademark Type

Standard Characters

### Goods

#### Class 31

(1) Fresh, raw and unprocessed hops.

#### Class 32

(2) Beer; Extracts of hops for making beer; Hop extracts for manufacturing beer; Processed hops for use in making beer; Processed pelletized hops for use in making beer.

### Claims

Priority Filing Date: November 10, 2020, Country or Office: UNITED STATES OF AMERICA,  
Application No: 90310669 in association with the same kind of goods

**Application Number** 2,119,501  
**International Registration Number** 1601154  
**Language of Application** English

**Filing Date** 2021-06-09

## APPLICANT AND AGENT DETAILS

### Applicant

Albert Kerbl GmbH  
Felizenzell 9  
84428 Buchbach  
GERMANY

### Agent

SMART & BIGGAR LP  
SUITE 900, 55 METCALFE STREET, P.O.  
BOX 2999, STATION D, OTTAWA, ONTARIO,  
K1P5Y6

## TRADEMARK DETAILS

# ECONOM

### Trademark Type

Standard Characters

### Goods

#### Class 07

Animal hair clippers

### Claims

Priority Filing Date: December 11, 2020, Country or Office: EUIPO (EU), Application No: 018352986 in association with the same kind of goods

**Application Number** 2,120,650  
**International Registration Number** 1602031  
**Language of Application** English

**Filing Date** 2021-02-25

## APPLICANT AND AGENT DETAILS

### Applicant

DELIVERECT NV  
Foreestelaan 82 bus 101  
B-9000 Gent  
BELGIUM

### Agent

LAVERY, DE BILLY, LLP  
1 Place Ville Marie, Suite 4000, Montréal,  
QUEBEC, H3B4M4

## TRADEMARK DETAILS

### Trademark Type

Design

### Visual Representation



### Trademark Description

The mark consists of a green circle featuring the white stylized lowercase letter "d" therein alongside the word "DELIVERECT" shown in green stylized font.

### Colour Claim

Colour is claimed as a feature of the trademark. The colours green and white are claimed as a feature of the trademark. The design is green with a white stylized 'd'. The word DELIVERECT is green.

### Services

#### Class 42

Software design and development; software development services, namely, design and development of computer software for data transfer in the field of food delivery services; computer software development; software design, namely, computer software design; software programming, namely, programming of computer software for others; software implementation, namely, design, development and implementation of software; electronic data storage namely, archiving business documents, personal documents and corporate documents; data authentication services, namely, providing user authentication services using single sign-on technology for online software applications; certification services, namely, testing, analysis, and evaluation of the data transmission services of others in the field of food delivery services to determine conformity with certification standards; advisory services relating to computer software; advisory services relating to computer systems design; advisory services relating to computer software design; design of

computer databases; database development services; digital asset management, namely, providing temporary use of web-based software applications for enabling users to manage electronic data associated with food orders and food delivery services; platform as a service (PAAS) featuring computer software platforms for transferring data in the field of food delivery services; software as a service (SAAS) services featuring software for data transfer in the field of food delivery services; development of computer platforms for third parties; design and development of computer software for electronic data storage systems; design and development of computer software for electronic data processing systems; design and development of computer software in the field of data processing for food ordering and food delivery services; development of computer based networks, namely, computer services in the nature of creating computer network-based indexes of information, websites and resources

**Claims**

Priority Filing Date: September 03, 2020, Country or Office: EUIPO (EU), Application No: 018301218 in association with the same kind of services

**Application Number** 2,120,814  
**International Registration Number** 1602534  
**Language of Application** English

**Filing Date** 2021-04-30

## APPLICANT AND AGENT DETAILS

### Applicant

Bora Creations S.L.  
11, Calle Velázquez (Pto. de Andratx)  
E-07157 Andratx, Balearen  
SPAIN

### Agent

BORDEN LADNER GERVAIS LLP  
World Exchange Plaza, 100 Queen Street,  
Suite 1300, Ottawa, ONTARIO, K1P1J9

## TRADEMARK DETAILS

# BEAUTY GREAT AGAIN

### Trademark Type

Standard Characters

### Goods

#### Class 03

(1) perfumery; cosmetics; decorative cosmetics; nail care products namely, nail art pens; nail gel; nail primers; nail cleaning foams for cosmetic purposes; nail polish base coat; nail polish top coat; nail hardeners; nail oils for cosmetic purposes; haircare products, namely hair shampoos, hair rinses, hair fixing oil, hair creams, hair gels, hair glazes, cosmetic hair dressings preparations, hair lacquers, hair lotions, hair moisturizers, hair mousses, hair sprays, hair conditioners, hair tonics, dandruff shampoos, hair dyes, tints for the hair; setting preparations for the hair; perfumes; eau de parfum; toilet water; eau de cologne.

#### Class 08

(2) hand-operated tools and instruments for the cosmetic and decorative care of finger and foot nails, eyelashes and eyebrows, namely, emery boards, nail files, fingernail polishers, foot care implements, namely, foot files, nail clippers, cuticle tweezers, nail scissors, cuticle nippers, cuticle pushers, hand cuticle trimmer, pincers, manicure and pedicure sets, nail scissors, nail clippers, rosewood sticks for use as manicure and pedicure implements, tongs for use as manicure and pedicure implements, tweezers, applicators for false eye lashes; nail files; hand-operated tools and instruments for the cosmetic and decorative care of finger and foot nails, namely, emery boards, nail files, fingernail polishers, foot care implements, namely, foot files, nail clippers, cuticle tweezers, nail scissors, cuticle nippers, cuticle pushers, hand cuticle trimmer, pincers, manicure and pedicure sets.

#### Class 21

(3) hair brushes; body brushes; nail brushes; hair combs; makeup applicators; cosmetic sponges.

### Claims

Priority Filing Date: November 05, 2020, Country or Office: EUIPO (EU), Application No: 018333533 in association with the same kind of goods

**Application Number** 2,120,889  
**International Registration Number** 1602463  
**Language of Application** English

**Filing Date** 2021-05-11

## APPLICANT AND AGENT DETAILS

### Applicant

Music & Lights S.r.l.  
Via Appia Km 136, 200  
I-04020 Itri  
ITALY

### Agent

SMART & BIGGAR LP  
SUITE 900, 55 METCALFE STREET, P.O.  
BOX 2999, STATION D, OTTAWA, ONTARIO,  
K1P5Y6

## TRADEMARK DETAILS

### Trademark Type

Design

### Visual Representation

# Smart Bat

### Goods

#### Class 11

Light diffusers, all aforementioned goods regarding entertainment, stage lighting, film, broadcast and professional lighting industry; floodlights, all aforementioned goods regarding entertainment, stage lighting, film, broadcast and professional lighting industry; LED light assemblies for commercial lighting and buildings, all aforementioned goods regarding entertainment, stage lighting, film, broadcast and professional lighting industry; LED luminaires, all aforementioned goods regarding entertainment, stage lighting, film, broadcast and professional lighting industry; stage spotlights, all aforementioned goods regarding entertainment, stage lighting, film, broadcast and professional lighting industry; decorative lighting sets, namely, LED light projectors, all aforementioned goods regarding entertainment, stage lighting, film, broadcast and professional lighting industry; Decorative lighting sets, namely, laser light projectors, all aforementioned goods regarding entertainment, stage lighting, film, broadcast and professional lighting industry; LED lighting installations for ceilings used to illuminate walkways, stairs, and doors of buildings, all aforementioned goods regarding entertainment, stage lighting, film, broadcast and professional lighting industry; LED lighting fixtures for shops, museums, hotels and cruise ships, all aforementioned goods regarding entertainment, stage lighting, film, broadcast and professional lighting industry; computer controlled stage spotlights, all aforementioned goods regarding entertainment, stage lighting, film, broadcast and professional lighting industry; portable lamps [for illumination], all aforementioned goods regarding entertainment, stage lighting, film, broadcast and professional lighting industry; illuminant lamps for projectors, all aforementioned goods regarding entertainment, stage lighting, film, broadcast and professional lighting industry; outdoor lighting fittings, all aforementioned goods regarding entertainment, stage lighting, film, broadcast and professional lighting industry; LED lighting installations, all aforementioned goods regarding

entertainment, stage lighting, film, broadcast and professional lighting industry; outdoor electrical lighting fixtures, all aforementioned goods regarding entertainment, stage lighting, film, broadcast and professional lighting industry; film stage lighting apparatus, namely, theatre spotlights, all aforementioned goods regarding entertainment, stage lighting, film, broadcast and professional lighting industry; electrical lamps for outdoor lighting, all aforementioned goods regarding entertainment, stage lighting, film, broadcast and professional lighting industry; light-emitting diodes [LED] lighting luminaires, all aforementioned goods regarding entertainment, stage lighting, film, broadcast and professional lighting industry.



**Application Number** 2,120,980  
**International Registration Number** 1602206  
**Language of Application** English

**Filing Date** 2021-05-19

## APPLICANT DETAILS

### Applicant

Nios Inc.  
315 W. 57th Street Suite 308  
New York NY 10019  
UNITED STATES OF AMERICA

## TRADEMARK DETAILS

# Noyah

### Trademark Type

Standard Characters

### Goods

#### Class 03

Body and beauty care cosmetics; cosmetic creams for skin care; cosmetic hand creams; cosmetic nourishing creams; cosmetic preparations for body care; cosmetic preparations for skin care; cosmetics and make-up; cosmetics, namely, lip repairers; lip balm; lip cream; lip gloss; lip gloss palette; lip liner; lipstick; lotions for cosmetic purposes; non-medicated balms for use on lips; skin conditioning creams for cosmetic purposes.

**Application Number** 2,121,125  
**Language of Application** English

**Filing Date** 2021-07-14

## APPLICANT AND AGENT DETAILS

### Applicant

Huijie Wen  
2 households, No. 139, Zhongqu Village,  
Chaoyang Town, Shouyang County  
Shanxi Province, 045400  
CHINA

### Agent

LEI GAO  
18 King Street East, Suite 1400, Toronto,  
ONTARIO, M5C1C4

## TRADEMARK DETAILS

# EASTERSTAR

### Trademark Type

Standard Characters

### Goods

#### Class 11

aquarium lights; bicycle lights; Christmas tree lights; diving lights; electric lamps; fairy lights for festive decoration; humidifiers; incandescent light bulbs; lanterns; led luminaires; lighting fixtures; luminaires; miners' lamps; motorcycle lights; safety lamps for underground use; searchlights; stage spotlights; street lamps; table lamps

**Application Number** 2,121,264  
**Language of Application** English

**Filing Date** 2021-07-15

## APPLICANT DETAILS

### Applicant

guhageethan kathirgamanathan  
3637 rue agona  
h7p6g8  
laval  
QUEBEC  
h7p6g8

## TRADEMARK DETAILS

### Trademark Type

Design

### Visual Representation





### Colour Claim

Colour is claimed as a feature of the trademark. Background Black, Outline and lettering - for the brave - in orange, guha and inner design white

### Goods

#### Class 25

(1) A-shirts; athletic clothing; athletic pants; athletic shirts; babies' pants; baby pants; baseball caps and hats; baseball hats; baseball shirts; belts; breeches; button down shirts; capri pants; cargo pants; casual and athletic clothing; casual clothing; casual clothing featuring pants, dresses and shorts; casual pants; casual shirts; children's clothing; children's shirts; cloth hats; clothing for babies; clothing for children; clothing for sports; clothing in particular pants; clothing in the nature of pants; clothing particularly pants; collared shirts; denim pants; denim shirts; dress clothing; dress pants; dress shirts; fashion hats; fleece pants; fleece shirts; fur hats; golf hats; graphic t-shirts; hats; infant clothing; jeans; jogging pants; knit hats; knit shirts; knitted hats; knitted shirts; leather pants; long sleeve shirts; long-sleeved shirts; long-sleeved t-shirts; lounge pants; men's shirts; mock turtleneck shirts; muscle shirts; night shirts; open-necked shirts; pant suits; pants; pique shirts; polo shirts; printed t-shirts; promotional t-shirts; rain hats; rain pants; shirts; shirts for suits; short pants; short-sleeve shirts; short-sleeved shirts; short-sleeved t-shirts; ski pants; small hats; snap crotch shirts for infants and toddlers; snow pants; snowboard pants; sport shirts; sports caps and hats; sports pants; sports shirts; sports shirts with short sleeves; straw hats; stretch pants; sun hats; sweat pants; sweat shirts; sweatshirts; t-shirts; team shirts; tee shirts; tee-shirts; tennis shirts; top hats; track pants; ushankas [fur hats]; vests; warm-up pants; waterproof jackets and pants; waterproof pants; women's shirts; woolly hats; woven shirts; yoga pants

#### Class 26

(2) belt buckles for clothing; belt buckles of precious metal for clothing; shirt buttons

### Services

**Class 35**

online sales of clothing; operation of a clothing store; retail clothing store services; retail sale of clothing; retail services provided by clothing boutiques; retail store services featuring clothing

**Application Number** 2,121,498  
**Language of Application** English

**Filing Date** 2021-07-16

## APPLICANT AND AGENT DETAILS

### Applicant

Arctic Glacier Canada Inc.  
625 Henry Avenue  
Winnipeg  
MANITOBA  
R3A0V1

### Agent

MLT AIKINS LLP  
2100 Livingston Place, 222-3rd Avenue SW,  
Calgary, ALBERTA, T2P0B4

## TRADEMARK DETAILS

### Trademark Type

Design

### Visual Representation



### Goods

Class 30

Ice.

**Application Number** 2,121,873  
**Language of Application** English

**Filing Date** 2021-07-20

## APPLICANT AND AGENT DETAILS

### Applicant

S. C. Johnson & Son, Inc.  
1525 Howe Street  
Racine, WI 53403-2236  
UNITED STATES OF AMERICA

### Agent

BERESKIN & PARR LLP/S.E.N.C.R.L., S.R.L.  
SCOTIA PLAZA, 40 KING STREET WEST,  
40th FLOOR, TORONTO, ONTARIO, M5H3Y2

## TRADEMARK DETAILS

# OFF! PATIO GUARD

### Trademark Type

Standard Characters

### Goods

#### Class 05

(1) fungicides; insect repellents; insecticides; moth repellents; preparations for killing weeds and destroying vermin; rodenticides

#### Class 11

(2) candle lanterns; electric lamps; electric lanterns

**Application Number** 2,121,974  
**Language of Application** English

**Filing Date** 2021-07-21

### **APPLICANT AND AGENT DETAILS**

**Applicant**

S-Corp Global Limited  
22 Frederick St  
Floor 7  
Kitchener  
ONTARIO  
N2H6M6

**Agent**

GEOFFREY J. NORTH  
(anticIPate Law), 4 Ironside Court, Ottawa,  
ONTARIO, K2K3H6

### **TRADEMARK DETAILS**

**Trademark Type**

Design

**Visual Representation**

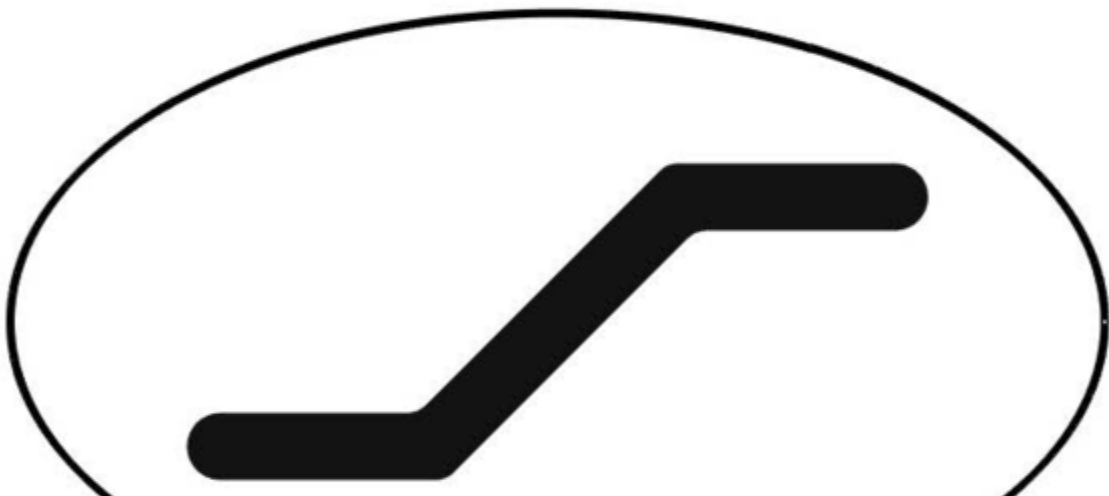





**Goods**

**Class 14**

gold; gold alloys; gold bullion

**Application Number** 2,122,271  
**International Registration Number** 1603452  
**Language of Application** English

**Filing Date** 2021-05-07

## APPLICANT AND AGENT DETAILS

### Applicant

Siemens Healthcare GmbH  
Henkestraße 127  
91052 Erlangen  
GERMANY

### Agent

SMART & BIGGAR LP  
SUITE 900, 55 METCALFE STREET, P.O.  
BOX 2999, STATION D, OTTAWA, ONTARIO,  
K1P5Y6

## TRADEMARK DETAILS

# Breast Health Moods

### Trademark Type

Standard Characters

### Goods

#### Class 10

(1) Furniture adapted for medical use and furniture especially made for medical examinations and treatments, namely, tables for medical use, beds for medical use, seats for medical purposes

#### Class 16

(2) Works of fine art, pictures, posters, graphic prints, graphic drawings, art prints, photographs [printed]

### Services

#### Class 42

Design of interior decor.

### Claims

Priority Filing Date: November 23, 2020, Country or Office: EUIPO (EU), Application No: 018343142 in association with the same kind of goods and in association with the same kind of services

**Application Number** 2,122,534  
**Language of Application** English

**Filing Date** 2021-07-22

## APPLICANT AND AGENT DETAILS

### Applicant

Subway IP LLC  
325 Sub Way  
Milford, CT 06461  
UNITED STATES OF AMERICA

### Agent

ROBIC  
630, boul. René-Lévesque Ouest, 20e étage,  
Montréal, QUEBEC, H3B1S6

## TRADEMARK DETAILS

# SUBWAY CAFÉ

### Trademark Type

Standard Characters

### Services

#### Class 43

catering of food and drinks; fast-food restaurants; restaurant services; self service restaurants; take-away fast food services; take-out restaurant services

**Application Number** 2,123,341  
**Language of Application** English

**Filing Date** 2021-07-28

## APPLICANT DETAILS

### Applicant

Can Liu  
No.15, Xinjian Cunmin Group, Chaoyang  
Community  
Taohuajiang Town, Taojiang County  
Hunan, 413400  
CHINA

## TRADEMARK DETAILS

# iGANK

### Trademark Type

Standard Characters

### Goods

#### Class 09

bathroom scales; chronographs for use as specialized time recording apparatus; cinematographic cameras; computer keyboards; computer mouse; digital cameras; electronic kitchen timers; electronic weighing scales for personal use; pedometers; sandglasses; scales with body mass analysers; shutter releases for cameras; shutters for cameras; smart rings; smartglasses; smartwatches; sports whistles; step counter; tripods for cameras

**Application Number** 2,123,353  
**Language of Application** English

**Filing Date** 2021-07-28

## APPLICANT AND AGENT DETAILS

### Applicant

Shenzhen Jiashun New Energy Co., Ltd.  
No. 6-301, Pitoubei 3rd Alley, Ailian  
Community, Longcheng St.  
Longgang Dist.  
Shenzhen, 518172  
CHINA

### Agent

YURI CHUMAK  
c/o Dickinson Wright LLP, 199 Bay Street,  
Suite 2200, Toronto, ONTARIO, M5L1G4

## TRADEMARK DETAILS

# JSTOC

### Trademark Type

Standard Characters

### Goods

#### Class 21

bakeware; barbecue mitts; brushes for washing up; cages for household pets; camping grills;  
cooking utensils; cruets; dinnerware; electrical toothbrushes; gardening gloves; make-up brushes;  
paper plates; plates; stands for shaving brushes

**Application Number** 2,123,942  
**International Registration Number** 1604717  
**Language of Application** English

**Filing Date** 2021-06-16

## APPLICANT AND AGENT DETAILS

### Applicant

Lifesize Plans IP Pty Ltd  
Wintergarden Plaza,  
L 15 1 o'Connell St  
Sydney NSW 2000  
AUSTRALIA

### Agent

JOHN H. SIMPSON  
(SHIFT LAW PROFESSIONAL  
CORPORATION), 60 St. Clair Ave. East, Suite  
403, Toronto, ONTARIO, M4T1N5

## TRADEMARK DETAILS

# LIFESIZE

### Trademark Type

Standard Characters

### Foreign Character Translation

### Services

#### Class 37

(1) Advisory services relating to the construction of buildings; building construction supervision services relating to shopping centers, industrial complexes, office buildings, residential buildings and other real estate developments; advisory services relating to the construction of buildings; civil engineering construction consultancy; advisory services relating to the maintenance, repair and renovation of buildings and other structures, namely, shopping centers, industrial complexes, office buildings, residential buildings; building construction supervision; building construction services; building construction advisory services; building construction consultancy; building construction supervision; building project management [construction supervision]; consultancy in civil engineering building construction; construction, maintenance and renovation of buildings; construction, maintenance and renovation of property; on-site construction supervision; providing construction information; providing on-line information relating to building construction, and repair and installation services; Providing advisory services relating to the construction of buildings; providing information on building construction and repair; provision of information in relation to building construction; shopping centers, industrial complexes, office buildings and residential buildings construction services; supervision of building construction; construction project management services; building construction supervision services for real estate projects

#### Class 42

(2) Architectural services relating to the development of land; architectural consultation; architectural project management; architectural services; architectural services relating to land development; design services for architecture; consultancy relating to architectural planning; architectural design services; preparation of architectural reports; preparation of reports relating to architecture; architectural research; construction drafting; research in the field of building construction.

**Application Number** 2,123,952  
**International Registration Number** 1604307  
**Language of Application** English

**Filing Date** 2021-06-19

## APPLICANT AND AGENT DETAILS

### Applicant

Lifesize Plans IP Pty Ltd  
Wintergarden Plaza  
L 15 1 o'Connell St, Sydney NSW 2000  
AUSTRALIA

### Agent

JOHN H. SIMPSON  
(SHIFT LAW PROFESSIONAL  
CORPORATION), 60 St. Clair Ave. East, Suite  
403, Toronto, ONTARIO, M4T1N5

## TRADEMARK DETAILS

### Trademark Type

Design

### Visual Representation

**LIFESIZE**

**PLANS**

### Colour Claim

Colour is claimed as a feature of the trademark. The word LIFESIZE is black and the letters of the word PLANS as well as the small dots and lines inside the letters are teal

### Services

#### Class 35

(1) Administration of the business affairs of franchises; business advertising services, namely, providing marketing assistance relating to the operation of franchises; business advisory services relating to the operation of franchises

#### Class 37

(2) Advisory services relating to the maintenance, repair and renovation of buildings and other structures, namely, shopping centers, industrial complexes, office buildings, residential buildings; consultancy services relating to the construction of buildings; building project management;

advisory services relating to the construction of buildings; construction and maintenance services relating to building construction civil engineering; advisory services relating to the construction of buildings and other structures. namely, shopping centers, industrial complexes, office buildings, residential buildings; building construction services; building construction advisory services; building construction supervision; building project management [construction supervision]; consultation in building construction supervision; real estate development [building and construction services]; providing information on building construction ; providing on-line information relating to building construction, and repair and installation services; Providing advisory services relating to the construction of buildings; supervision of building construction

**Class 42**

(3) Architectural project management; architectural services; architectural consultation; preparation of reports relating to architecture; design services for architecture; architectural and civil engineering services; preparation of architectural plans; civil engineering drawing; construction drafting; architectural research services; research in the field of building construction

**Claims**

Priority Filing Date: June 11, 2021, Country or Office: AUSTRALIA, Application No: 2186040 in association with the same kind of services



**Application Number** 2,124,434  
**Language of Application** English

**Filing Date** 2021-07-31

## APPLICANT DETAILS

### Applicant

Loudi Chenmao Technology Co., Ltd.  
No.116, Building 3, (Zone B)  
Wujiang International Building Materials City  
Economic and Technological Development  
Zone  
Loudi, Hunan, 417000  
CHINA

## TRADEMARK DETAILS

# Yoskely

**Trademark Type**  
Standard Characters

### Goods

#### Class 21

baking mats; cooking utensils; rolling pins for cooking purposes; spaghetti tongs; spatulas for kitchen use; sprinklers for watering flowers and plants

**Application Number** 2,124,435  
**Language of Application** English

**Filing Date** 2021-07-31

## APPLICANT DETAILS

### Applicant

Xiamen Qingzhimai Information Technology  
Co., Ltd  
Room 402, No.2366, Fangzhong Road, Huli  
District  
Xiamen, Fujian, 361000  
CHINA

## TRADEMARK DETAILS

# Yogipace

### Trademark Type

Standard Characters

### Goods

#### Class 25

athletic apparel; balaclavas; casual wear; cyclists' clothing; head bands; rain pants; ski clothing;  
socks; sun protective clothing; yoga pants

**Application Number** 2,124,436  
**Language of Application** English

**Filing Date** 2021-07-31

## APPLICANT DETAILS

### Applicant

Yunfeng Ni  
8333 Rochester Avenue Suite 107  
Rancho Cucamonga, CA 91739  
UNITED STATES OF AMERICA

## TRADEMARK DETAILS

# Juegoal

### Trademark Type

Standard Characters

### Goods

#### Class 28

baby swings; baby toys; board games; Christmas stockings; Christmas tree skirts; costume masks; electronic action toys; flying discs; inflatable pool toys; play tents; swimming rings; toy Christmas trees

**Application Number** 2,124,437  
**Language of Application** English

**Filing Date** 2021-07-31

## APPLICANT DETAILS

### Applicant

Lei Hong  
8333 Rochester Avenue Suite 107  
Rancho Cucamonga, CA 91739  
UNITED STATES OF AMERICA

## TRADEMARK DETAILS

# SAND MINE

### Trademark Type

Standard Characters

### Goods

#### Class 27

anti-slip floor coverings for use on staircases; anti-slip floor mats; area rugs; bath mats; beach mats; carpet tiles for covering floors; carpet underlay; cloth wall coverings; decorative wall hangings, not of textile; door mats; fabric wall coverings; floor mats; mushiro [straw mats]; personal sitting mats; pet feeding mats; rubber mats; straw mats; vehicle carpets; vinyl floor coverings; wallpaper in the nature of room-size decorative adhesive wall coverings; woven straw mats

**Application Number** 2,124,438  
**Language of Application** English

**Filing Date** 2021-07-31

## APPLICANT DETAILS

**Applicant**  
Shenzhen Riyo Innovation Technology Co., Ltd.

Rm. 302,Bldg. E,  
Queshan Guanghao Industrial Park,Dalang St.,  
Longhua Dist.,Shenzhen, 518000  
CHINA

## TRADEMARK DETAILS

**Trademark Type**  
Design

**Visual Representation**



**Goods****Class 09**

acoustic couplers; cabinets for loudspeakers; cases for smartphones; cell phone battery chargers; cell phone holders; chargers for electronic cigarettes; computer hardware; computer mouse; computers and computer hardware; covers for tablet computers; digital music players; ear pads for headphones; electric connectors; headphones; headsets; holders for electric coils; protective films adapted for smartphone screens; selfie sticks for use with smartphones; stands adapted for laptops; USB cables

**Application Number** 2,124,516  
**Language of Application** English

**Filing Date** 2021-08-02

## APPLICANT DETAILS

**Applicant**

Dongting Li  
3705-11 Wellesley St W  
M4Y 0G4  
Toronto  
ONTARIO  
M4Y0G4

## TRADEMARK DETAILS

**Trademark Type**

Design

**Visual Representation**



**Colour Claim**

Colour is claimed as a feature of the trademark. The color is blue

**Goods****Class 28**

bath toys; battery operated action toys; beach toys; childrens toy bicycles; decorations for Christmas trees; inflatable pool toys; party balloons; play balloons; toy balloons



**Application Number** 2,124,529  
**Language of Application** English

**Filing Date** 2021-08-02

## APPLICANT DETAILS

**Applicant**  
Hui Wong  
605 Symons Crossing  
Milton  
ONTARIO  
L9T7S2

## TRADEMARK DETAILS

**Trademark Type**  
Design

**Visual Representation**



**Colour Claim**

Colour is claimed as a feature of the trademark. Gold (Entire Logo)

**Goods****Class 21**

bake ware; bakeware; baking dishes; beer glasses; beer mugs; beverage containers; beverage glassware; bowls; ceramic jugs; ceramic mugs; china dinnerware; chinaware; coffee cups; coffee mugs; cups; cups and mugs; dinner plates; dinnerware; dishes; dishes and plates; dishes for soap; drinking cups; drinking flasks; drinking flasks for travelers; drinking glasses; earthenware; earthenwares; fruit bowls; glass bowls; glass dishes; insulated flasks; insulating flasks; Japanese rice bowls [chawan]; Japanese style earthenware mortars [suribachi]; Japanese style soup serving bowls [wan]; mixing bowls; mugs; pet bowls; pet feeding and drinking bowls; pet feeding dishes; plates; porcelain mugs; pottery; ramekins; salad bowls; serving bowls (hachi); serving dishes; soap dishes; soup bowls; table glassware; thermal insulated containers for food and beverages; thermal insulated containers for food or beverages; thermally insulated containers for food; travel mugs; water bottles; water bottles sold empty

Application Number 2,124,530  
Language of Application English

Filing Date 2021-08-02

## APPLICANT AND AGENT DETAILS

### Applicant

Semond Scipio  
128 Edgewater Dr  
Stoney Creek  
ONTARIO  
L8E4Z3

### Agent

MARK ARTHUR KOCH PROFESSIONAL  
CORPORATION  
Att'n: Mark A. Koch, 34 King's Grant Road, St  
Catharines, ONTARIO, L2N2R8

## TRADEMARK DETAILS

### Trademark Type

Design

### Visual Representation

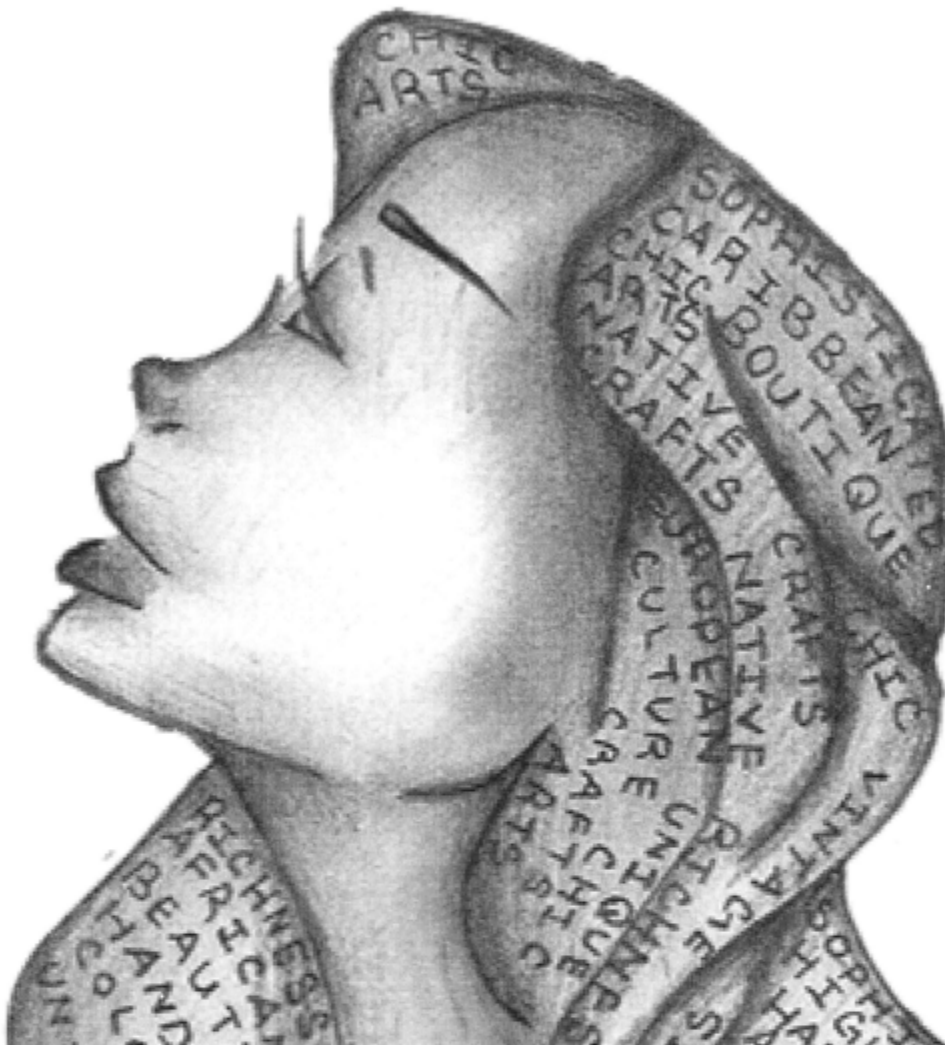



**Application Number** 2,124,596  
**Language of Application** English

**Filing Date** 2021-08-03

## APPLICANT AND AGENT DETAILS

### Applicant

Trademarks Grupo Modelo, S. de R.L. de C.V.  
Cerrada Palomas 22, Reforma Social, Miguel  
Hidalgo, 11650  
MEXICO

### Agent

BARRETTE LEGAL INC.  
445 Viger Ouest, Suite 200, Montreal,  
QUEBEC, H2Z2B8

## TRADEMARK DETAILS

# CORONA TROPICAL

### Trademark Type

Standard Characters

### Goods

#### Class 33

Carbonated alcoholic drink with flavor, namely hard seltzer.

**Application Number** 2,124,916  
**Language of Application** English

**Filing Date** 2021-08-04

## APPLICANT AND AGENT DETAILS

### Applicant

PointsBet Pty Limited  
155 Cremorne Street  
Cremorne, Victoria, 3121  
AUSTRALIA

### Agent

GOWLING WLG (CANADA) LLP  
SUITE 1600, 1 FIRST CANADIAN PLACE, 100  
KING STREET WEST, TORONTO, ONTARIO,  
M5X1G5

## TRADEMARK DETAILS

### Trademark Type

Design

### Visual Representation

***POINTS BET***

### Goods

#### Class 09

computer game software for playing online casino games; downloadable game software for use on computers and mobile devices for on-line gambling; downloadable mobile application for horse race betting; downloadable mobile application for playing online casino games; downloadable mobile application for sports betting; downloadable software for online sports betting;

### Services

#### Class 41

betting services; entertainment in the nature of fantasy sports leagues; gambling services; online casino gaming services; online gambling services; operation of betting platforms; providing non-downloadable casino games and video games via the Internet; sports betting services provided via an online betting platform; wagering services;

**Application Number** 2,125,075  
**International Registration Number** 1606361  
**Language of Application** English

**Filing Date** 2021-04-07

## APPLICANT AND AGENT DETAILS

### Applicant

Guangxi Yuchai Machine Group Company  
Limited  
No. 2 Yuchai Road,  
Yuzhou District, Yulin  
Guangxi  
CHINA

### Agent

NEOMARK LTD.  
7450 rue Saint-Hubert, Montréal, QUEBEC,  
H2R2N3

## TRADEMARK DETAILS

### Trademark Type

Design

### Visual Representation



### Trademark Description

Color is not claimed as a feature of the mark. The mark consists of four non-Latin characters above the wording "YC DIESEL" with the background of black rectangle. Adjacent and to the left of the wording is the letter "Y" superimposed on an oval design with the background of black square. The first two non-Latin characters appearing in the mark are transliterated as "YU CHAI" and have no special meaning when combined as a whole. The last two non-Latin characters appearing in the mark are transliterated as "JI QI" and mean "machine".

### Disclaimer

The right to the exclusive use of the words being the last two non-Latin characters that mean 'machine' and 'diesel' is disclaimed apart from the trademark.

### Foreign Character Translation

The translation provided by the applicant of the Chinese word(s) YU CHAI JI QI is that the mark has no special meaning when combined as a whole.

### Foreign Character Transliteration

The transliteration provided by the applicant of the Chinese character(s) is YU CHAI JI QI.

### Goods

Class 07

(1) Agricultural cultivators; pneumatic transporters; dynamos; pistons for engines; cooling radiators for motors and engines; gas filters for engines; diesel airplane engines; diesel boat engines; diesel engines for concrete mixers; diesel engines for industrial machinery; diesel engines for power generators; diesel marine engines; motors for boats; generators of electricity; self-regulating fuel pumps

**Class 12**

(2) Forklift trucks; tilting-carts; electric cars; trucks; driving motors for land vehicles; engines for land vehicles; mopeds; sprinkling trucks

**Services****Class 35**

(1) Export and import agencies; advisory services for business management; business management consultancy; development of marketing strategies and concepts for others; procurement of contracts for the purchase and sale of goods and services; development of promotional campaigns for others; market studies

**Class 37**

(2) Motor vehicle maintenance and repair; vehicle washing services; providing information on repair services in the aviation sector; vehicle cleaning



**Application Number** 2,125,220  
**International Registration Number** 1605394  
**Language of Application** English

**Filing Date** 2021-05-31

## APPLICANT AND AGENT DETAILS

### Applicant

Demand Science Group, LLC  
222 Rosewood Dr  
Danvers MA 01923  
UNITED STATES OF AMERICA

### Agent

WENDY D. RIEL  
(RIEL PROFESSIONAL CORPORATION), c/o  
MDK Business Law Professional Corporation,  
441 MacLaren Street, Suite 200B, Ottawa,  
ONTARIO, K2P2H3

## TRADEMARK DETAILS

### Trademark Type

Design

### Visual Representation



### Trademark Description

The mark consists of the word "DEMANDSCIENCE" with triangles forming the upper part of each "d" and the "i", to the right of five thick, parallel lines of different shades with circles at the tops of the right three lines.

### Services

#### Class 35

Marketing services for others, namely providing sales leads by identifying, activating and converting buyers; providing demand creation and lead generation in the area of sales.

### Claims

Priority Filing Date: December 10, 2020, Country or Office: UNITED STATES OF AMERICA, Application No: 90372075 in association with the same kind of services

**Application Number** 2,125,463  
**Language of Application** English

**Filing Date** 2021-08-05

## APPLICANT DETAILS

**Applicant**

Guanyu Zhou  
102-3521 Rue Saint-Dominique  
Montréal  
QUEBEC  
H2X2X5

## TRADEMARK DETAILS

**Trademark Type**

Design

**Visual Representation**

思 蕾

Le Soleil Comesti

**Foreign Character Translation**

Translation of the two Chinese characters in the trademark is THINK and BUD.

**Foreign Character Transliteration**

Transliteration of the two Chinese characters in the trademark is SI LEI.

**Goods**

Class 29

(1) butter; canned fruits and vegetables; cheese; dried fruit and vegetables; edible oils and edible fats; french fries; frozen fruits; fruit and vegetable salads; fruit bars; fruit chips; fruit jellies; fruit juices for cooking; fruit salads and vegetable salads; fruit-based snack food; ham; hot dogs; jams; meat; meat by-products; milk and milk products; milk beverages containing fruits; milk beverages with high milk content; milk shakes; nut-based snack mixes; potato chips; preserved fruit and vegetables; sausages; seafood; soy milk; yogurt

**Class 30**

(2) biscuits; bread and buns; cakes; candies; chocolate; chocolate syrups; cocoa; cocoa-based beverages; coffee; coffee based beverages; coffee beverages with milk; coffee essences; coffee extracts; coffee substitutes; coffee syrups; cookies and crackers; corn syrup; donuts; fruit flavourings; fruit teas; maple syrup; milk chocolate; pies; popcorn; puddings; seasonings; sugar; sugar substitutes; tea; tea beverages with milk; vanilla; waffles

**Class 32**

(3) beers; bottled water; fruit beverages; fruit drinks and juices; fruit flavoured drinks; fruit juices; fruit-based beverages; non-alcoholic beverages containing fruit juices; non-alcoholic beverages containing vegetable juices; non-alcoholic beverages flavored with coffee; non-alcoholic beverages flavored with tea; non-alcoholic fruit cocktails; non-alcoholic fruit extracts; smoothies; soda water; soft drinks; sports drinks; syrups for beverages; vegetable juices; vegetable-based beverages

**Services****Class 43**

bar services; cafeterias; coffee and tea bars; fast food and non-stop restaurant services; juice bars; milk bar services; mobile restaurant services; restaurant services; restaurants; take-out restaurant services; tea bar services; teahouse services

**Application Number** 2,126,349  
**International Registration Number** 1607648  
**Language of Application** English

**Filing Date** 2020-11-22

## APPLICANT AND AGENT DETAILS

### Applicant

SICHUAN YIBIN WULIANGYE GROUP CO.,  
LTD.  
#150, Minjiang West Road,  
Yibin  
Sichuan  
CHINA

### Agent

NEOMARK LTD.  
7450 rue Saint-Hubert, Montréal, QUEBEC,  
H2R2N3

## TRADEMARK DETAILS

### Trademark Type

Design

### Visual Representation

五 粮 液  
WULIANGYE

### Trademark Description

The mark consists of stylized Chinese characters WU LIANG YE and stylized words of WU LIANG YE underneath the Chinese characters.

### Foreign Character Translation

The translation provided by the applicant of the Chinese word(s) WU LIANG YE is "five", "grain" and "liquid".

### Foreign Character Transliteration

The transliteration provided by the applicant of the Chinese character(s) is WU LIANG YE.

### Services

Class 35

Advertising agencies; presentation of goods for others via the internet, for retail purposes; organization of trade fairs for commercial and advertising purposes of a variety of goods for others; organization of exhibitions for commercial and advertising purposes of a variety of goods for others; business management of hotels; business management assistance; commercial administration of the licensing of the goods and services of others; import-export agency services; direct marketing of the goods and services of others; promoting the goods and services of others through advertisements on Internet websites.

**Application Number** 2,126,768  
**International Registration Number** 1606651  
**Language of Application** English

**Filing Date** 2021-06-15

## APPLICANT AND AGENT DETAILS

### Applicant

Nippon Gear Co., Ltd.  
1-7-14 Nishi-Shinbashi,  
Minato-ku  
Tokyo  
JAPAN

### Agent

NELLIGAN O'BRIEN PAYNE LLP  
300-50 O'CONNOR STREET, OTTAWA,  
ONTARIO, K1P6L2

## TRADEMARK DETAILS

### Trademark Type

Design

### Visual Representation

### Trademark Description

A coined word which has no meaning.

### Goods

#### Class 09

- (1) Electric liner actuators; electric valve actuators.
- (2) Frequency converter for actuators; frequency converters; electric current controller devices; electric control panels; solenoid valves [electromagnetic switches]; torque meters.

### Claims

Priority Filing Date: December 25, 2020, Country or Office: JAPAN, Application No: 2020-160212 in association with the same kind of goods (1); June 01, 2021, Country or Office: JAPAN, Application No: 2021-066855 in association with the same kind of goods (2)

**Application Number** 2,126,835  
**International Registration Number** 1606484  
**Language of Application** English

**Filing Date** 2021-06-25

## APPLICANT AND AGENT DETAILS

### Applicant

CHPS Inc.  
20-14, Daesagwan-ro 11-gil,  
Yongsan-gu  
Seoul  
REPUBLIC OF KOREA

### Agent

MILLER IP LAW  
84 Neilson Drive, Toronto, ONTARIO, M9C1V7

## TRADEMARK DETAILS

### Trademark Type

Design

### Visual Representation

**YCH**

### Goods

#### Class 25

Caps; hats; mufflers; winter gloves; under garments; shawls; scarves; sports wear; shoes; training shoes; sneakers; mules; pumps being footwear; socks; pants; jackets; coats; dresses; blouses; skirts; shirts; t-shirts; leggings; belts [clothing]; gloves [clothing]

**Application Number** 2,126,964  
**Language of Application** English

**Filing Date** 2021-08-12

## APPLICANT AND AGENT DETAILS

### Applicant

Dongting Li  
Unit 3705, 11 Wellesley St West  
Toronto  
ONTARIO  
M4Y0G4

### Agent

GOWLING WLG (CANADA) LLP  
SUITE 2600, 160 ELGIN STREET, OTTAWA,  
ONTARIO, K1P1C3

## TRADEMARK DETAILS

### Trademark Type

Design

### Visual Representation





**Goods****Class 28**

Party supplies, namely party hats, party favors in the nature of noisemakers, party games, party poppers, party streamers, party blowers; Balloons, namely party balloons and play balloons; water toys; water guns; Kids toys, namely stuffed toys, construction toys, toy figures, plush toys, baby toys, talking toys, musical toys, toy dolls, toy animals, infant toys, action figure toys, small toys, bath toys, crib toys, bathtub toys, plastic toys, toy buildings, toy cars, toy vehicles, squeeze toys, beach toys, inflatable toys, pet toys; Christmas decorations

**Application Number** 2,127,045  
**Language of Application** English

**Filing Date** 2021-08-12

## **APPLICANT DETAILS**

### **Applicant**

Tota LLC  
2202 S Rangeline Rd Suite B  
Joplin, MO 64804  
UNITED STATES OF AMERICA

## **TRADEMARK DETAILS**

# **MacCheesy's**

### **Trademark Type**

Standard Characters

### **Services**

#### **Class 43**

carry-out restaurant services; restaurant services

**Application Number** 2,127,115  
**Language of Application** English

**Filing Date** 2021-08-13

## APPLICANT DETAILS

### Applicant

KBZ TECH INC  
1156 S Saint Paul St.  
Denver, CO 80210  
UNITED STATES OF AMERICA

## TRADEMARK DETAILS

# Uensh

### Trademark Type

Standard Characters

### Goods

#### Class 09

(1) 3D spectacles; adapter plugs; bags adapted for laptops; battery chargers for mobile phones; burglar alarms; cabinets for loudspeakers; camcorders; car video recorders; cases for smartphones; cell phone straps; computer hardware for data processing; computer keyboards; computer monitors; computer mouse; computer printers; computer scanners; computer utility programs for providing diagnostic details on devices installed in a computer system; covers for smartphones; covers for tablet computers; data cables; electric batteries for cameras; electric batteries for portable computers; electric batteries for smartphones; electric batteries for tablet computers; electric batteries for watches; electric door bells; electric light switches; electric sockets; electric wires; electronic book readers; electronic calculators; electronic collars to train animals; electronic digital signboards, namely, luminous signs and neon signs; electronic pocket translators; eyeglasses; global positioning system (GPS) consisting of computers, computer software, transmitters, receivers, and network interface devices; hand-held monopod; loudspeakers; mouse pads; portable DVD players; portable MP3 players; protective films adapted for computer screens; protective films adapted for screens for mobile phones; protective films adapted for smart phones; protective helmets for sports; radar; sleeves for laptops; smartwatches; solar batteries; sunglasses; tripods for cameras; video baby monitors; video monitors; video screens; wireless computer mice

#### Class 11

(2) air fryers; air purifiers for household purposes; aquarium lights; automobile lights; barbecues; bath installations; bread baking machines; carbon for arc lamps; ceiling lights; chandeliers; disinfectant dispensers for toilets; electric blankets for household purposes; electric bulbs; electric coffee machines; electric cooking griddles; electric cooking pots and pans; electric deep fryers; electric discharge tubes for lighting; electric fans for household purposes; electric flashlights; electric kettles; electric lamps; electric lights for christmas trees; facial steamers; fairy lights for festive decoration; freezers; germicidal lamps; germicidal lamps for purifying air; hair dryers; hand showers; headlights for automobiles; humidifiers; ice machines; incandescent burners; lamp casings; laser light projectors; laundry drying machines; led luminaires; light bulbs; lights for vehicles; multicookers; nail lamps; patio heaters; portable electric fans; portable headlamps;

searchlights; stage spotlights; string lights for festive decoration; taps for pipes and pipelines; water filtering units for domestic use

### **Class 21**

(3) animal grooming gloves; beverage containers; bird baths; bowls; cages for pets; china ornaments; combs for animals; cookery moulds; cooking utensils; cosmetic brushes; cups; cutlery trays; dishes; drinking cups; drinking flasks; drinking straws; drinking troughs; electric and non-electric lint removers; electric combs; electric toothbrushes; eyelash brushes; fitted toilet cases; fitted toiletry cases; fitted vanity cases; fly swatters; fly traps; food and beverage containers for household use; food storage containers; fruit muddlers; gloves for household purposes; hair for brushes; hand-operated pepper mills; Japanese style cooked rice scoops [shamoji]; jugs; litter boxes for pets; make-up brushes; make-up sponges; mangers for animals; mouse traps; pet feeding and drinking bowls; pitchers; plug-in diffusers for mosquito repellents; porcelain eggs; powder puffs; rings for birds; table glassware; table plates; toilet brushes; toothbrushes; waste receptacles; water apparatus for cleaning teeth and gums; works of art made of glass

### **Services**

#### **Class 35**

advertising agency services; advertising by transmission of on-line publicity for third parties through electronic communications networks; advertising flyer distribution for others; advertising on the Internet for others; advertising services provided via the internet, namely, promoting the goods of others by providing information regarding discounts and special offers for the goods of others; advertising text publication services for others; advertising the goods and services of others in periodicals, brochures and newspapers; advertising the goods and services of others through all public communication means; advice and information about customer services and product management and prices on Internet sites in connection with purchases made over the Internet; auctioneering; billing services; business administration consultancy; business administration consulting services; business management assistance; consulting in the fields of business organization and management; creating and updating advertising material for others; direct mail advertising of the goods and services of others; direct marketing of the goods and services of others; dissemination of advertising for others via the Internet; dissemination of advertising matter for others; distribution of advertising materials for others; import and export agencies; layout services for advertising purposes; market analysis; market research services; marketing analysis services; marketing services in the field of evaluating markets for existing goods and services of others; on-line advertising for others on computer networks; organization of exhibitions of flowers and plants for commercial or advertising purposes; organization of fashion shows for promotional purposes; personnel management consultancy; procurement of contracts for the purchase and sale of goods and services; product demonstration services in shop windows by live models; production of advertising films for others; promoting the goods and services of others by arranging for sponsors to affiliate their goods and services with live concert events; promoting the goods and services of others through advertisements on Internet websites; promoting the goods and services of others through infomercials; providing a searchable online advertising guide featuring the goods and services of other on-line vendors on the internet; providing and rental of advertising space on the internet; providing home shopping services of home entertainment electronics by means of television; provision of an on-line marketplace for buyers and sellers of goods and services; publication of publicity texts; publicity agency services; publicity agents; publicity bureau services; retail furniture store services; sales promotion for others by means of privileged user cards; telemarketing services; television advertising for others; updating and maintenance of data in computer databases

**Application Number** 2,127,117  
**Language of Application** English

**Filing Date** 2021-08-13

## APPLICANT DETAILS

### Applicant

Shenzhen L-Star Commerce CO., LTD.  
B308, 1970 TECHNOLOGY ZONE  
MINZHI ST., LONGHUA DIST.  
SHENZHEN, 518000  
CHINA

## TRADEMARK DETAILS

# Zrysu

### Trademark Type

Standard Characters

### Goods

#### Class 09

(1) 3D spectacles; adapter plugs; bags adapted for laptops; battery chargers for mobile phones; burglar alarms; cabinets for loudspeakers; camcorders; car video recorders; cases for smartphones; cell phone straps; computer hardware for data processing; computer keyboards; computer monitors; computer mouse; computer printers; computer scanners; computer utility programs for providing diagnostic details on devices installed in a computer system; covers for smartphones; covers for tablet computers; data cables; electric batteries for cameras; electric batteries for portable computers; electric batteries for smartphones; electric batteries for tablet computers; electric batteries for watches; electric door bells; electric light switches; electric sockets; electric wires; electronic book readers; electronic calculators; electronic collars to train animals; electronic digital signboards, namely, luminous signs and neon signs; electronic pocket translators; eyeglasses; global positioning system (GPS) consisting of computers, computer software, transmitters, receivers, and network interface devices; hand-held monopod; loudspeakers; mouse pads; portable DVD players; portable MP3 players; protective films adapted for computer screens; protective films adapted for screens for mobile phones; protective films adapted for smart phones; protective helmets for sports; radar; sleeves for laptops; smartwatches; solar batteries; sunglasses; tripods for cameras; video baby monitors; video monitors; video screens; wireless computer mice

#### Class 11

(2) air fryers; air purifiers for household purposes; aquarium lights; automobile lights; barbecues; bath installations; bread baking machines; carbon for arc lamps; ceiling lights; chandeliers; disinfectant dispensers for toilets; electric blankets for household purposes; electric bulbs; electric coffee machines; electric cooking griddles; electric cooking pots and pans; electric deep fryers; electric discharge tubes for lighting; electric fans for household purposes; electric flashlights; electric kettles; electric lamps; electric lights for christmas trees; facial steamers; fairy lights for festive decoration; freezers; germicidal lamps; germicidal lamps for purifying air; hair dryers; hand showers; headlights for automobiles; humidifiers; ice machines; incandescent burners; lamp casings; laser light projectors; laundry drying machines; led luminaires; light bulbs; lights for

vehicles; multicookers; nail lamps; patio heaters; portable electric fans; portable headlamps; searchlights; stage spotlights; string lights for festive decoration; taps for pipes and pipelines; water filtering units for domestic use

### **Class 21**

(3) animal grooming gloves; beverage containers; bird baths; bowls; cages for pets; china ornaments; combs for animals; cookery moulds; cooking utensils; cosmetic brushes; cups; cutlery trays; dishes; drinking cups; drinking flasks; drinking straws; drinking troughs; electric and non-electric lint removers; electric combs; electric toothbrushes; eyelash brushes; fitted toilet cases; fitted toiletry cases; fitted vanity cases; fly swatters; fly traps; food and beverage containers for household use; food storage containers; fruit muddlers; gloves for household purposes; hair for brushes; hand-operated pepper mills; Japanese style cooked rice scoops [shamoji]; jugs; litter boxes for pets; make-up brushes; make-up sponges; mangers for animals; mouse traps; pet feeding and drinking bowls; pitchers; plug-in diffusers for mosquito repellents; porcelain eggs; powder puffs; rings for birds; table glassware; table plates; toilet brushes; toothbrushes; waste receptacles; water apparatus for cleaning teeth and gums; works of art made of glass

### **Services**

#### **Class 35**

advertising agency services; advertising by transmission of on-line publicity for third parties through electronic communications networks; advertising flyer distribution for others; advertising on the Internet for others; advertising services provided via the internet, namely, promoting the goods of others by providing information regarding discounts and special offers for the goods of others; advertising text publication services for others; advertising the goods and services of others in periodicals, brochures and newspapers; advertising the goods and services of others through all public communication means; advice and information about customer services and product management and prices on Internet sites in connection with purchases made over the Internet; auctioneering; billing services; business administration consultancy; business administration consulting services; business management assistance; consulting in the fields of business organization and management; creating and updating advertising material for others; direct mail advertising of the goods and services of others; direct marketing of the goods and services of others; dissemination of advertising for others via the Internet; dissemination of advertising matter for others; distribution of advertising materials for others; import and export agencies; layout services for advertising purposes; market analysis; market research services; marketing analysis services; marketing services in the field of evaluating markets for existing goods and services of others; on-line advertising for others on computer networks; organization of exhibitions of flowers and plants for commercial or advertising purposes; organization of fashion shows for promotional purposes; personnel management consultancy; procurement of contracts for the purchase and sale of goods and services; product demonstration services in shop windows by live models; production of advertising films for others; promoting the goods and services of others by arranging for sponsors to affiliate their goods and services with live concert events; promoting the goods and services of others through advertisements on Internet websites; promoting the goods and services of others through infomercials; providing a searchable online advertising guide featuring the goods and services of other on-line vendors on the internet; providing and rental of advertising space on the internet; providing home shopping services of home entertainment electronics by means of television; provision of an on-line marketplace for buyers and sellers of goods and services; publication of publicity texts; publicity agency services; publicity agents; publicity bureau services;

retail furniture store services; sales promotion for others by means of privileged user cards; telemarketing services; television advertising for others; updating and maintenance of data in computer databases

**Application Number** 2,127,119  
**Language of Application** English

**Filing Date** 2021-08-13

## APPLICANT DETAILS

### Applicant

Shenzhen Tiancheng Network Technology Co.,  
Ltd.  
A2002-2003, Bldg. 2, Phase II,  
Huananguojiyinshuazhipin Packaging Logistics  
Zone  
Longgang Dist.  
Shenzhen,  
CHINA

## TRADEMARK DETAILS

### Trademark Type

Design

### Visual Representation

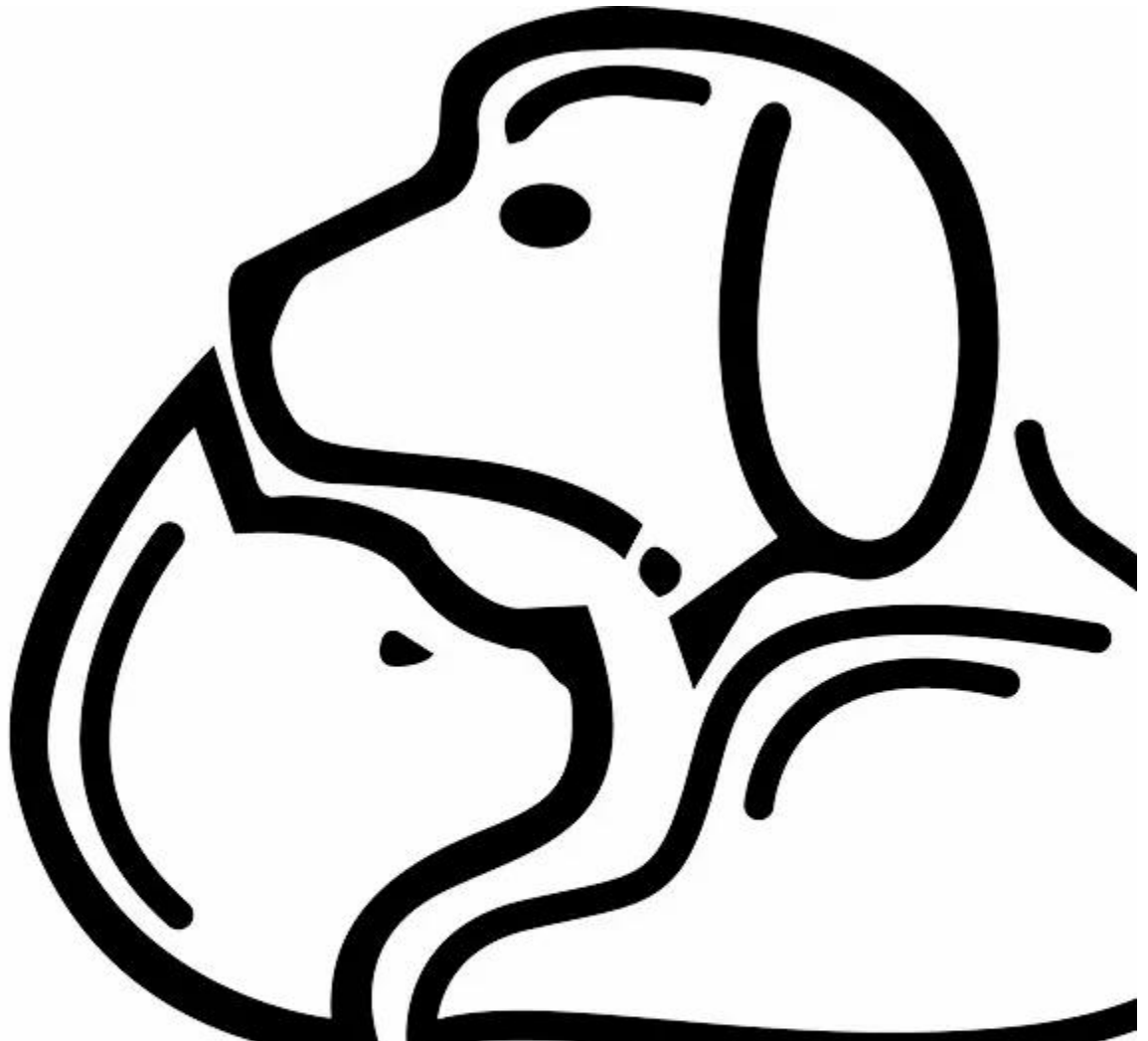





PETODA

**Goods****Class 21**

animal activated livestock feeders; animal activated livestock waterers; bird feeders; brushes for pets; combs for animals; dog food scoops; drinking troughs; feeding troughs; food storage containers; horse brushes; litter boxes for pets; litter trays for pets; mangers for animals; pet bowls; pet feeding dishes; scoops for pet waste

**Application Number** 2,127,120  
**Language of Application** English

**Filing Date** 2021-08-13

## **APPLICANT DETAILS**

### **Applicant**

Shangnuo (Shenzhen) E-Commerce Co., Ltd.  
403, No. 37, Area 2, Langkou Village, Langkou  
Community  
Dalang Street, Longhua District  
Shenzhen, Guangdong,  
CHINA

## **TRADEMARK DETAILS**

### **Trademark Type**

Design

### **Visual Representation**



**SIFVO**

**Goods**

**Class 09**

bicycle helmets; crash helmets; dust protective goggles; dust protective masks; head guards for sports; horse riding helmets; mouth guards for sports; protective sports helmets; reflective safety vests; safety helmets; skateboard helmets; sports goggles; sports helmets; visors for helmets; welding helmets

**Application Number** 2,127,121  
**Language of Application** English

**Filing Date** 2021-08-13

## APPLICANT DETAILS

### Applicant

Chujun Zhou  
No. 12, Sanzhi Alley, North Pian, Tushang  
Management District, Shenquan Town  
Huilai County, jieyan,  
CHINA

## TRADEMARK DETAILS

# Voamuw

### Trademark Type

Standard Characters

### Goods

#### Class 28

carnival masks; checkers games; chest expanders; parlor games; party favours in the nature of small toys; play motor cars; playing cards; puzzles; rattles for infants; shuttlecocks; small toys; sports balls; table tennis paddles; toy air pistols; toy binoculars; toy building blocks; toy building bricks; toy cameras; toy dolls

**Application Number** 2,127,122  
**Language of Application** English

**Filing Date** 2021-08-13

## **APPLICANT DETAILS**

**Applicant**  
ASC365 INTERNATIONAL LTD.  
2220 Midland Ave, Unit 60AP  
Scarborough  
ONTARIO  
M1P3E6

## **TRADEMARK DETAILS**

**intbuying**

**Trademark Type**  
Standard Characters

**Goods**

**Class 09**

ergometers; gas flow monitors; manometers; photometers; resuscitation mannequins; stills for laboratory experiments; weighbridges; weighing scales for medical use

**Application Number** 2,127,124  
**Language of Application** English

**Filing Date** 2021-08-13

## APPLICANT DETAILS

### Applicant

SHENZHEN UPHILL TRADING CO., LTD.  
A308, 1970 TECH PARK, MINKANG RD.  
MINZHI COMMUNITY, MINZHI, LONGHUA  
DIST.  
SHENZHEN, 518000  
CHINA

## TRADEMARK DETAILS

# Qedse

### Trademark Type

Standard Characters

### Goods

#### Class 09

(1) 3D spectacles; adapter plugs; bags adapted for laptops; battery chargers for mobile phones; burglar alarms; cabinets for loudspeakers; camcorders; car video recorders; cases for smartphones; cell phone straps; computer hardware for data processing; computer keyboards; computer monitors; computer mouse; computer printers; computer scanners; computer utility programs for providing diagnostic details on devices installed in a computer system; covers for smartphones; covers for tablet computers; data cables; electric batteries for cameras; electric batteries for portable computers; electric batteries for smartphones; electric batteries for tablet computers; electric batteries for watches; electric door bells; electric light switches; electric sockets; electric wires; electronic book readers; electronic calculators; electronic collars to train animals; electronic digital signboards, namely, luminous signs and neon signs; electronic pocket translators; eyeglasses; global positioning system (GPS) consisting of computers, computer software, transmitters, receivers, and network interface devices; hand-held monopod; loudspeakers; mouse pads; portable DVD players; portable MP3 players; protective films adapted for computer screens; protective films adapted for screens for mobile phones; protective films adapted for smart phones; protective helmets for sports; radar; sleeves for laptops; smartwatches; solar batteries; sunglasses; tripods for cameras; video baby monitors; video monitors; video screens; wireless computer mice

#### Class 11

(2) air fryers; air purifiers for household purposes; aquarium lights; automobile lights; barbecues; bath installations; bread baking machines; carbon for arc lamps; ceiling lights; chandeliers; disinfectant dispensers for toilets; electric blankets for household purposes; electric bulbs; electric coffee machines; electric cooking griddles; electric cooking pots and pans; electric deep fryers; electric discharge tubes for lighting; electric fans for household purposes; electric flashlights; electric kettles; electric lamps; electric lights for christmas trees; facial steamers; fairy lights for festive decoration; freezers; germicidal lamps; germicidal lamps for purifying air; hair dryers; hand showers; headlights for automobiles; humidifiers; ice machines; incandescent burners; lamp

casings; laser light projectors; laundry drying machines; led luminaires; light bulbs; lights for vehicles; multicookers; nail lamps; patio heaters; portable electric fans; portable headlamps; searchlights; stage spotlights; string lights for festive decoration; taps for pipes and pipelines; water filtering units for domestic use

### **Class 21**

(3) animal grooming gloves; beverage containers; bird baths; bowls; cages for pets; china ornaments; combs for animals; cookery moulds; cooking utensils; cosmetic brushes; cups; cutlery trays; dishes; drinking cups; drinking flasks; drinking straws; drinking troughs; electric and non-electric lint removers; electric combs; electric toothbrushes; eyelash brushes; fitted toilet cases; fitted toiletry cases; fitted vanity cases; fly swatters; fly traps; food and beverage containers for household use; food storage containers; fruit muddlers; gloves for household purposes; hair for brushes; hand-operated pepper mills; Japanese style cooked rice scoops [shamoji]; jugs; litter boxes for pets; make-up brushes; make-up sponges; mangers for animals; mouse traps; pet feeding and drinking bowls; pitchers; plug-in diffusers for mosquito repellents; porcelain eggs; powder puffs; rings for birds; table glassware; table plates; toilet brushes; toothbrushes; waste receptacles; water apparatus for cleaning teeth and gums; works of art made of glass

### **Services**

#### **Class 35**

advertising agency services; advertising by transmission of on-line publicity for third parties through electronic communications networks; advertising flyer distribution for others; advertising on the Internet for others; advertising services provided via the internet, namely, promoting the goods of others by providing information regarding discounts and special offers for the goods of others; advertising text publication services for others; advertising the goods and services of others in periodicals, brochures and newspapers; advertising the goods and services of others through all public communication means; advice and information about customer services and product management and prices on Internet sites in connection with purchases made over the Internet; auctioneering; billing services; business administration consultancy; business administration consulting services; business management assistance; consulting in the fields of business organization and management; creating and updating advertising material for others; direct mail advertising of the goods and services of others; direct marketing of the goods and services of others; dissemination of advertising for others via the Internet; dissemination of advertising matter for others; distribution of advertising materials for others; import and export agencies; layout services for advertising purposes; market analysis; market research services; marketing analysis services; marketing services in the field of evaluating markets for existing goods and services of others; on-line advertising for others on computer networks; organization of exhibitions of flowers and plants for commercial or advertising purposes; organization of fashion shows for promotional purposes; personnel management consultancy; procurement of contracts for the purchase and sale of goods and services; product demonstration services in shop windows by live models; production of advertising films for others; promoting the goods and services of others by arranging for sponsors to affiliate their goods and services with live concert events; promoting the goods and services of others through advertisements on Internet websites; promoting the goods and services of others through infomercials; providing a searchable online advertising guide featuring the goods and services of other on-line vendors on the internet; providing and rental of advertising space on the internet; providing home shopping services of home entertainment electronics by means of television; provision of an on-line marketplace for buyers and sellers of goods and services; publication of publicity texts; publicity agency services; publicity agents; publicity bureau services; retail furniture store services; sales promotion for others by means of privileged user cards;

telemarketing services; television advertising for others; updating and maintenance of data in computer databases



**Application Number** 2,127,125  
**Language of Application** English

**Filing Date** 2021-08-13

## APPLICANT DETAILS

### Applicant

Guangzhou Lanye Trading Co., Ltd.  
101, No. 9-1, Huancun Street, Dongguan  
Second Team  
Xinya Subdistrict, Huadu District  
Guangzhou, Guangdong, 510000  
CHINA

## TRADEMARK DETAILS

# IPOKO

### Trademark Type

Standard Characters

### Goods

#### Class 21

biodegradable bowls; biodegradable cups; bottle openers; bowls; bread baskets; cake moulds; camping grills; carpet sweepers; clothes drying hangers; clothes drying racks; clothes pegs; compostable and biodegradable plates, bowls, cups and trays; cookery moulds; cooking strainers; cooking utensils; cups; decanters; dinnerware; disposable table plates; drinking bottles for sports; electric bottle openers; flower baskets; food and beverage containers for household use; food storage containers; gift baskets sold empty; glass bottles; gloves for household purposes; ice buckets; ice cube moulds; isothermic bags; jugs; kitchen mitts; laundry baskets; mops; non-electric coffee pots; non-electric griddles; nylon coffee filters; picnic baskets; plastic bottles; scouring pads; shot glasses; take-out food containers; tea caddies; tea strainers; thermal insulated containers for food and beverages; waste baskets; water bottles; wine aerators; wine buckets; wine glasses; wine pourers

**Application Number** 2,127,128  
**Language of Application** English

**Filing Date** 2021-08-13

## APPLICANT DETAILS

### Applicant

Min Zhang  
No. 10 Shuzhuang Natural Village, Pugang  
Village, Jinniu Town, Lujiang County  
Hefei, Anhui,  
CHINA

## TRADEMARK DETAILS

# ZerUprin

### Trademark Type

Standard Characters

### Goods

#### Class 24

banners of textile and plastic; bed valances; coverings of plastic for furniture; covers of textile for toilet lids; flags of textile; furniture coverings of plastic; furniture coverings of textile; handkerchiefs of textile; indoor and outdoor curtains; mosquito nets; plastic table linens; shower curtains; silk fabrics; table napkins of textile; tablemats of textile; textile tablecloths

**Application Number** 2,127,130  
**Language of Application** English

**Filing Date** 2021-08-13

## APPLICANT DETAILS

### Applicant

Yahui Song  
No. 17, Xiangshan Avenue, Qiujin Town,  
Yongxiu County  
Jiujiang, Jiangxi,  
CHINA

## TRADEMARK DETAILS

# Deloky

### Trademark Type

Standard Characters

### Goods

#### Class 28

beach toys; carnival masks; decorations for Christmas trees; fishing poles; inflatable games for swimming pools; paper party hats; pet toys; play tents; snow globes; toy balloons; toy masks; toy models; toy pistols

**Application Number** 2,127,131  
**Language of Application** English

**Filing Date** 2021-08-13

## APPLICANT DETAILS

### Applicant

Hefei Jutou Electronic Technology Co., Ltd.  
1502, Jinhui Sunshine Building, Changjiang  
West Road  
Jinggang Town, Shushan District  
Hefei, Anhui,  
CHINA

## TRADEMARK DETAILS

# RunNico

### Trademark Type

Standard Characters

### Goods

#### Class 20

beds for household pets; blinds of reed, rattan or bamboo (sudare); decorations of plastic for foodstuffs; display stands; dog kennels; fodder racks; industrial packaging containers of bamboo; kennels for household pets; mattresses made of flexible wood; nesting boxes for household pets; pet cushions; placards of wood or plastics; plastic labels; scratching posts for cats; sea shells; signboards of wood or plastics; straw plaits; wind chimes; wood busts

**Application Number** 2,127,134  
**Language of Application** English

**Filing Date** 2021-08-13

## APPLICANT DETAILS

### Applicant

Guangzhou Lanye Trading Co., Ltd.  
101, No. 9-1, Huancun Street, Dongguan  
Second Team  
Xinya Subdistrict, Huadu District  
Guangzhou, Guangdong, 510000  
CHINA

## TRADEMARK DETAILS

# GIEEU

### Trademark Type

Standard Characters

### Goods

#### Class 21

biodegradable bowls; biodegradable cups; bottle openers; bowls; bread baskets; cake moulds; camping grills; carpet sweepers; clothes drying hangers; clothes drying racks; clothes pegs; compostable and biodegradable plates, bowls, cups and trays; cookery moulds; cooking strainers; cooking utensils; cups; decanters; dinnerware; disposable table plates; drinking bottles for sports; electric bottle openers; flower baskets; food and beverage containers for household use; food storage containers; gift baskets sold empty; glass bottles; gloves for household purposes; ice buckets; ice cube moulds; isothermic bags; jugs; kitchen mitts; laundry baskets; mops; non-electric coffee pots; non-electric griddles; nylon coffee filters; picnic baskets; plastic bottles; scouring pads; shot glasses; take-out food containers; tea caddies; tea strainers; thermal insulated containers for food and beverages; waste baskets; water bottles; wine aerators; wine buckets; wine glasses; wine pourers

**Application Number** 2,127,136  
**Language of Application** English

**Filing Date** 2021-08-13

## APPLICANT DETAILS

### Applicant

Guangzhou Lanye Trading Co., Ltd.  
101, No. 9-1, Huancun Street, Dongguan  
Second Team  
Xinya Subdistrict, Huadu District  
Guangzhou, Guangdong, 510000  
CHINA

## TRADEMARK DETAILS

# AOFLY

### Trademark Type

Standard Characters

### Goods

#### Class 21

biodegradable bowls; biodegradable cups; bottle openers; bowls; bread baskets; cake moulds; camping grills; carpet sweepers; clothes drying hangers; clothes drying racks; clothes pegs; compostable and biodegradable plates, bowls, cups and trays; cookery moulds; cooking strainers; cooking utensils; cups; decanters; dinnerware; disposable table plates; drinking bottles for sports; electric bottle openers; flower baskets; food and beverage containers for household use; food storage containers; gift baskets sold empty; glass bottles; gloves for household purposes; ice buckets; ice cube moulds; isothermic bags; jugs; kitchen mitts; laundry baskets; mops; non-electric coffee pots; non-electric griddles; nylon coffee filters; picnic baskets; plastic bottles; scouring pads; shot glasses; take-out food containers; tea caddies; tea strainers; thermal insulated containers for food and beverages; waste baskets; water bottles; wine aerators; wine buckets; wine glasses; wine pourers

**Application Number** 2,127,204  
**Language of Application** English

**Filing Date** 2021-08-13

## **APPLICANT DETAILS**

### **Applicant**

Phelix And Co.  
14757 14th Concession Rd  
Essex  
ONTARIO  
N8M2X6

## **TRADEMARK DETAILS**

# **We Fly As One**

### **Trademark Type**

Standard Characters

### **Goods**

#### **Class 25**

athletic apparel; athletic shirts; casual shirts; graphic t-shirts; t-shirts

**Application Number** 2,127,243  
**Language of Application** English

**Filing Date** 2021-08-14

## **APPLICANT DETAILS**

### **Applicant**

Nashid Chroma Art and Apparel  
118 Brunswick Ave  
Toronto  
ONTARIO  
M5S2M2

## **TRADEMARK DETAILS**

# **Art for Dreamers**

### **Trademark Type**

Standard Characters

### **Goods**

#### **Class 16**

art prints



**Application Number** 2,127,262  
**Language of Application** English

**Filing Date** 2021-08-14

## APPLICANT DETAILS

### Applicant

Florton Artias Consulting Inc.  
202-127 4th St E  
North Vancouver  
BRITISH COLUMBIA  
V7L1H7

## TRADEMARK DETAILS

# Know What You Own

### Trademark Type

Standard Characters

### Services

#### Class 35

(1) advertising services for promoting the brokerage of stocks and other securities for others; advice in the field of business management and marketing; business management consulting with relation to strategy, marketing, production, personnel and retail sale matters

#### Class 41

(2) educational services in the field of economics, financial planning and investment strategies

**Application Number** 2,127,268  
**Language of Application** English

**Filing Date** 2021-08-16

## APPLICANT DETAILS

### Applicant

Haoshuang Xiao  
No.68, Jimao Market, Xijiang Township  
Hanchuan, Hubei, 432300  
CHINA

## TRADEMARK DETAILS

### Trademark Type

Design

### Visual Representation



### Goods

#### Class 25

bath robes; beach clothes; bodices; brassières; coats; coats for men and women; corset undergarment; dressing gowns; jumpsuits; knitted tops; petticoats; pyjamas; sleepwear; sports singlets; tee-shirts; tights; togas; underpants; underwear; vests

**Application Number** 2,127,278  
**Language of Application** English

**Filing Date** 2021-08-16

## **APPLICANT AND AGENT DETAILS**

**Applicant**  
COMMONS SENSE COUNSEL IP HOLDINGS  
404 W. 7TH STREET  
AUSTIN, TX 78701  
UNITED STATES OF AMERICA

**Agent**  
MILTONS IP/P.I.  
#200-15 Fitzgerald Road, Ottawa, ONTARIO,  
K2H9G1

## **TRADEMARK DETAILS**

**SOLID GOLD**

**Trademark Type**  
Standard Characters

**Goods**  
**Class 04**  
candles

**Application Number** 2,127,292  
**Language of Application** English

**Filing Date** 2021-08-16

## **APPLICANT AND AGENT DETAILS**

**Applicant**

TOJA INC.  
450 South Service Road West  
Oakville  
ONTARIO  
L6K2H4

**Agent**

BHOLE IP LAW  
130 Queens Quay East, Suite 1214, Toronto,  
ONTARIO, M5A0P6

## **TRADEMARK DETAILS**

# **HOODIE COVER**

**Trademark Type**

Standard Characters

**Goods**

**Class 24**

covers for cushions; furniture coverings of textile

**Application Number** 2,127,336  
**Language of Application** English

**Filing Date** 2021-08-16

## APPLICANT AND AGENT DETAILS

### Applicant

Mark Harris  
20 Victoria Street  
Loughborough  
Leicestershire, LE11 2EN  
UNITED KINGDOM

### Agent

FIELD LLP  
213-304 Old Canmore Road, Canmore,  
ALBERTA, T1W0L5

## TRADEMARK DETAILS

### Trademark Type

Design

### Visual Representation

The image shows the word "Schei" in a large, bold, black, cursive script font. The letters are thick and have a fluid, flowing quality. The 'S' is particularly large and prominent, with a thick stroke and a rounded bottom. The 'h' is tall and narrow, with a thin vertical stem. The 'e' is rounded and has a thick stroke. The 'i' is small and has a thin stem with a small dot above it. The overall appearance is that of a stylized, handwritten font.

### Goods

#### Class 05

(1) vitamins for pets

#### Class 31

(2) consumable pet chews; dog biscuits; edible chewing bones for dogs; edible chews for dogs; edible chews for dogs for use in maintaining dental health; edible dog treats; edible pet treats; foodstuffs for dogs; pet foods

**Application Number** 2,127,404  
**Language of Application** English

**Filing Date** 2021-08-16

## APPLICANT DETAILS

### Applicant

Timea Forisek  
4328 Fisk Ave  
Prince George  
BRITISH COLUMBIA  
V2M5W7

## TRADEMARK DETAILS

# Simple Existence Products Ltd.

### Trademark Type

Standard Characters

### Goods

#### Class 18

animal leashes; bags for carrying pets; clothing for domestic pets; clothing for pets; collars for pets; collars for pets bearing medical information; dog leashes; leashes for animals; leashes for dogs; leashes for pets; pet leashes

**Application Number** 2,127,419  
**Language of Application** English

**Filing Date** 2021-08-16

## APPLICANT AND AGENT DETAILS

### Applicant

Green Drop Ltd.  
1230 Meridian Road NE  
Calgary  
ALBERTA  
T2A2N9

### Agent

LISA D. STATT FOY  
(Field LLP), 400 - 444 7 Avenue SW,  
CALGARY, ALBERTA, T2P0X8

## TRADEMARK DETAILS

# DEW

### Trademark Type

Standard Characters

### Goods

#### Class 01

(1) anti-freezing and de-icing preparations; compost; fertilizer; planting soil; potting soil; soil conditioners; top soil

#### Class 05

(2) herbicides; insecticides

#### Class 31

(3) grass seed; mulch

**Application Number** 2,127,441  
**Language of Application** English

**Filing Date** 2021-08-16

## APPLICANT AND AGENT DETAILS

### Applicant

Abdullahi I. Ali Doing business as Warya  
Enterprise  
1213 Jonathan Drive  
Oakville  
ONTARIO  
L6J7H6

### Agent

GOWLING WLG (CANADA) LLP  
SUITE 1600, 1 FIRST CANADIAN PLACE, 100  
KING STREET WEST, TORONTO, ONTARIO,  
M5X1G5

## TRADEMARK DETAILS

**Trademark Type**

Design

**Visual Representation**





**Goods**

**Class 25**

athletic shirts; baseball hats; casual shirts; golf shirts; hats and caps; shirts; t-shirts

**Application Number** 2,127,442  
**Language of Application** English

**Filing Date** 2021-08-16

## **APPLICANT DETAILS**

### **Applicant**

Moskeeter Shield inc.  
9465 Walker Rd  
5  
McGregor  
ONTARIO  
N0R1J0

## **TRADEMARK DETAILS**

# **Moskeeter Shield**

### **Trademark Type**

Standard Characters

### **Services**

#### **Class 37**

pest control services for residential use

**Application Number** 2,127,458  
**Language of Application** English

**Filing Date** 2021-08-16

## APPLICANT DETAILS

### Applicant

Southland Waters Corp  
333 SE 2 AV  
STE 2000  
MIAMI, FL 33131  
UNITED STATES OF AMERICA

## TRADEMARK DETAILS

# SANIFLUID

### Trademark Type

Standard Characters

### Goods

#### Class 01

(1) chlorine for general industrial use

#### Class 03

(2) bathroom cleaning preparations; cleaning preparations for bathroom use; cleaning preparations for dishes; cleaning preparations for use in toilets; cleaning solution for oral vaporizers for smoking; cleaning solutions for dental ultrasonic sterilization apparatus; cleansers for intimate personal hygiene purposes, non medicated; denture cleaning preparations; face cleaning wipes; hand cleaning preparations; nasal cleaning preparations for personal sanitary purposes; non-medicated cleaning preparations for use on the body; non-medicated liquid preparations for cleaning the hands; non-medicated tooth cleaning preparations for dogs; preparations for cleaning dentures; wipes impregnated with a skin cleanser; wipes impregnated with cleansing preparations for pets; wipes impregnated with skincare preparations

#### Class 05

(3) all purpose disinfectants; all purpose sanitizers; all-purpose disinfectants; all-purpose disinfecting and deodorizing preparations; disinfectant toilet bowl cleaners; disinfectants for chemical toilets; disinfectants for dental and medical apparatus and instruments; disinfectants for dental apparatus and instruments; disinfectants for household purposes; disinfectants for household use; disinfectants for medical apparatus and instruments; disinfectants for medical instruments; disinfecting hand wash; disinfecting handwash; disposable sanitizing wipes; egg sanitizing preparations; fingernail sanitizers; hand sanitizers; hand-sanitizing preparations; nail sanitizing preparations; preparations for sanitizing eggs; sanitizing wash for fruit and vegetables; sanitizing wipes; sterilized dressing; urinary tract disinfectants

#### Class 21

(4) household cleaning towelettes

**Application Number** 2,127,480  
**Language of Application** English

**Filing Date** 2021-08-16

## **APPLICANT DETAILS**

### **Applicant**

Kowshik Sharan Subramanian  
674 Josephine Ave  
Windsor  
ONTARIO  
N9B2L3

## **TRADEMARK DETAILS**

### **Trademark Type**

Design

### **Visual Representation**



### **Goods**

#### **Class 09**

data cables; electronic cables; USB cables; USB cables for cellular phones; USB cables for mobile phones

**Application Number** 2,127,492  
**Language of Application** English

**Filing Date** 2021-08-16

## APPLICANT DETAILS

### Applicant

SHENZHEN LIUSING TRADING CO., LTD.  
RM308, 1970 TECH PARK  
MINZHI COMMUNITY, MINZHI, LONGHUA  
DIST.  
SHENZHEN, 518000  
CHINA

## TRADEMARK DETAILS

# Kqoba

### Trademark Type

Standard Characters

### Goods

#### Class 25

(1) adhesive bras; aprons; athletic clothing; bath robes; bathing caps; bathing drawers; body suits; boots; brassières; caps; cloth bibs; clothing for gymnastics; coats; cyclists' clothing; dresses; footwear for children; gaiters; girdles; gloves; hosiery; jackets; jerseys; knitted sweaters; layettes; liveries; masquerade costumes; neckties; outerwear jackets; overcoats; panty girdles; pullovers; pyjamas; scarfs; shirts; skirts; slippers; smocks; sports jerseys; stockings; suspenders; sweaters; swimsuits; tee-shirts; tights; trousers; underpants; underwear; vests; yoga pants; yoga tops

#### Class 26

(2) arm bands as clothing accessories; artificial Christmas garlands incorporating lights; artificial Christmas wreaths; artificial Christmas wreaths incorporating lights; artificial flowers; artificial fruit; artificial garlands; beads for handicraft work; brassards; brooches for clothing; buttons for clothing; cords for trimming; corset busks; decorative cords; electric hair curlers; embroidered badges for clothing; embroidery; embroidery for garments; embroidery needles; false beards; false hair; false hems; false moustaches; frills for clothing; hair bands; hair clips; hair colouring caps; hair curling papers; hair curling pins; hair extensions; hair nets; hair ornaments; hair ornaments in the form of combs; hair pins; human hair; knitting needles; lace for edgings; lace trimmings; needle cases; non-electric hair curlers; ornamental novelty badges; ornamental ribbons made of textile; plaited hair; ribbons for the hair; safety pins; shoe laces; toupees; tresses of hair; wigs; wreaths of artificial flowers

**Application Number** 2,127,495  
**Language of Application** English

**Filing Date** 2021-08-16

## APPLICANT DETAILS

### Applicant

SHENZHEN SOURCE-RICE E-COMMERCE  
TRADING CO., LTD.  
308, 1970 TECH PARK, NO. 112  
MINKANG RD., MINZHI, LONGHUA DIST.  
SHENZHEN, 518000  
CHINA

## TRADEMARK DETAILS

# Rkdlo

### Trademark Type

Standard Characters

### Goods

#### Class 25

(1) adhesive bras; aprons; athletic clothing; bath robes; bathing caps; bathing drawers; body suits; boots; brassières; caps; cloth bibs; clothing for gymnastics; coats; cyclists' clothing; dresses; footwear for children; gaiters; girdles; gloves; hosiery; jackets; jerseys; knitted sweaters; layettes; liveries; masquerade costumes; neckties; outerwear jackets; overcoats; panty girdles; pullovers; pyjamas; scarfs; shirts; skirts; slippers; smocks; sports jerseys; stockings; suspenders; sweaters; swimsuits; tee-shirts; tights; trousers; underpants; underwear; vests; yoga pants; yoga tops

#### Class 26

(2) arm bands as clothing accessories; artificial Christmas garlands incorporating lights; artificial Christmas wreaths; artificial Christmas wreaths incorporating lights; artificial flowers; artificial fruit; artificial garlands; beads for handicraft work; brassards; brooches for clothing; buttons for clothing; cords for trimming; corset busks; decorative cords; electric hair curlers; embroidered badges for clothing; embroidery; embroidery for garments; embroidery needles; false beards; false hair; false hems; false moustaches; frills for clothing; hair bands; hair clips; hair colouring caps; hair curling papers; hair curling pins; hair extensions; hair nets; hair ornaments; hair ornaments in the form of combs; hair pins; human hair; knitting needles; lace for edgings; lace trimmings; needle cases; non-electric hair curlers; ornamental novelty badges; ornamental ribbons made of textile; plaited hair; ribbons for the hair; safety pins; shoe laces; toupees; tresses of hair; wigs; wreaths of artificial flowers

**Application Number** 2,127,496  
**Language of Application** English

**Filing Date** 2021-08-16

## APPLICANT DETAILS

### Applicant

Guangzhou Jieyou Network Technology Co.,  
LTD  
Room E5033, Unit 1, No. 12, Yinli Street  
Shatai Road, Tianhe District  
Guangzhou, 510600  
CHINA

## TRADEMARK DETAILS

# BROUYOUE

### Trademark Type

Standard Characters

### Goods

#### Class 28

artificial fishing bait; badminton rackets; chess games; children's multiple activity toys; Christmas tree ornaments and decorations; Christmas trees of synthetic material; dolls; dolls' rooms; electronic hand-held games; foosball tables; inflatable pools for recreational use; knee guards for sports use; rods for fishing; snow skis; stuffed toys; table tennis rackets; tennis rackets; toy robots; toy sling planes; toy vehicles; toys for pets

**Application Number** 2,127,498  
**Language of Application** English

**Filing Date** 2021-08-16

## APPLICANT DETAILS

### Applicant

xiaoyan Wang  
31 Floor, No.1 News Building,1002 Shennan  
Mid Road, Futian District  
Shenzhen, Guangdong,  
CHINA

## TRADEMARK DETAILS

# Toycod

### Trademark Type

Standard Characters

### Goods

#### Class 10

condoms; diaphragms for contraception; dildos; facial massagers; flavoured condoms; love dolls; menstrual cups; personal vibrators; sex dolls; sex toys; vaginal syringes; vibrators massagers



**Application Number** 2,127,499  
**Language of Application** English

**Filing Date** 2021-08-17

## APPLICANT DETAILS

### Applicant

Guangzhou Wodeng Information Technology  
Co., Ltd.  
Rm 1104-2969, No.47, Qiaolin St  
Tianhe North Rd, Tianhe Dist  
Guangzhou City, 510000  
CHINA

## TRADEMARK DETAILS

# GTGR

### Trademark Type

Standard Characters

### Goods

#### Class 08

biodegradable cutlery; bread knives; butcher knives; cake cutters; chef knives; compostable cutlery; disposable cutlery; electric hair trimmers; electric manicure sets; electric razors; emergency hammers; fingernail clippers; fishing knives; folding knives; gardening tools; hex keys; household knives; hunting knives; kitchen knives; knife sharpeners; knives, forks and spoons being tableware; multi-purpose shears; nail clippers; non-electric vegetable peelers; paper shears; paring knives for household use; planing blades; plastic cutlery; sabres; snow shovels; sport knives; table cutlery

**Application Number** 2,127,502  
**Language of Application** English

**Filing Date** 2021-08-17

## APPLICANT DETAILS

### Applicant

Zeyao Xiao  
No. 69, Gaotian Village, Shicheng Town  
Lianjiang, Guangdong, 524499  
CHINA

## TRADEMARK DETAILS

# DTDR

### Trademark Type

Standard Characters

### Goods

#### Class 21

bottle openers; bowls; cake molds; candy boxes; chopsticks; cookie cutters; cosmetic brushes; cutting boards for the kitchen; dinnerware; electric and non-electric lint removers; food storage containers; frying pans; garlic presses; glass ornaments; jugs; lunch boxes; mess-tins; mouse traps; pots and pans; tea service; toothbrushes

**Application Number** 2,127,504  
**Language of Application** English

**Filing Date** 2021-08-17

## APPLICANT AND AGENT DETAILS

### Applicant

Zhejiang Milian Technology Co., Ltd.  
Room 216, 162 Xianglong Road  
Nanmingshan Street, (Lijing National Industrial  
Park)  
Lishui City, Zhejiang Province, 323000  
CHINA

### Agent

PAUL B. BÉLANGER  
4360 av de Hampton, MONTRÉAL, QUEBEC,  
H4A2L2

## TRADEMARK DETAILS

**zii**

### Trademark Type

Standard Characters

### Goods

#### Class 06

(1) electronic safes; keys of metal; locks of metal for doors; locks of metal for vehicles; metal padlocks; metal strong boxes; safes; safety cashboxes; spring locks; wire rope

#### Class 12

(2) anti-theft alarms for vehicles; anti-theft devices for motor cars; baskets adapted for bicycles; bicycle bells; bicycle saddles; horns for motor vehicles; panniers adapted for cycles; panniers adapted for motorcycles; reversing alarms for vehicles; saddlebags adapted for bicycles

**Application Number** 2,127,506  
**Language of Application** English

**Filing Date** 2021-08-17

## APPLICANT DETAILS

### Applicant

SHENZHEN P&S BUSINESS CO., LTD.  
308, 1970 TECH PARK, MINZHI COMMUNITY  
MINZHI ST., LONGHUA DIST.  
SHENZHEN, 518000  
CHINA

## TRADEMARK DETAILS

# Qyreb

### Trademark Type

Standard Characters

### Goods

#### Class 03

(1) aromatic essential oils; aromatic potpourris; artificial fingernails; bar soap; bath gels; beauty creams; beauty soap; cloths impregnated with a detergent for cleaning; cosmetic pencils; cosmetic preparations for eyelashes; cotton sticks for cosmetic purposes; cotton wool buds for cosmetic use; cream soaps; cuticle removing preparations; cuticle removing preparations for cosmetic purposes; decalcomanias for fingernails; depilatories; dishwashing detergents; douching toiletry preparations for personal sanitary and deodorant purposes; dry-cleaning preparations; drying agents for dishwashing machines; eye cream; eyebrow cosmetics; eyeshadow; fabric softeners for laundry use; facial beauty masks; facial cleansers; facial cream; false eyelashes; fingernail decals; floor wax removers; javelle water; laundry bleaching preparations; laundry starch; lip balm; lip cream; lip glosses; lipsticks; liquid perfumes; makeup; nail polish; perfumery; polish for furniture and flooring; shaving balm; shoe cream; shoe polish; toilet bowl detergents; toothpaste; wallpaper cleaning preparations; windscreen cleaning liquids

#### Class 08

(2) baby spoons, table forks and table knives; beard clippers; ceramic knives; crimping iron hand tools; curling tongs; cuticle nippers; ear-piercing apparatus; electric and non-electric depilation appliances; electric fingernail polishers; electric hair clippers; electric hair trimmers; electric hand-held hair styling irons; electric manicure sets; electric nail files; electrolysis apparatus for hair removal; emery boards; eyelash curlers; fruit segmenters; hair clippers for animals being hand instruments; hair-removing tweezers; hand-operated hand tools; hand-operated lifting jacks; hand-operated spanners; hand-operated vegetable shredders; hobby knives; household knives; kitchen mandolines; knives, forks and spoons being tableware; manicure sets; nail clippers; nail files; non-electric can openers; non-electric egg slicers; non-electric fingernail polishers; non-electric hair clippers; paring knives for household use; pedicure sets; pliers; punches being hand tools; razor blades; razor cases; razors; scissors; screwdrivers; sharpening stones; shaving cases; shovels; sterile body piercing instruments; tattoo needles; tattooing needles; tweezers; vegetable peelers

#### Class 21

(3) bamboo place mats; bowls; brooms; cake molds; citrus juicers; coffee scoops; cookery molds; cookery moulds; cooking funnels; cooking utensils; cork place mats; cosmetic brushes; cosmetic spatulas; cups; dishes; dishes and plates; drinking glasses; drinking straws; egg separators; fitted vanity cases; flower pots; food and beverage containers for household use; food storage containers; glass bottles; gloves for household purposes; hand-operated coffee grinders; hand-operated pepper mills; jugs; make-up brushes; make-up sponges; manual egg beaters; mixing spoons; non-electric griddles; oven mitts; painted glassware; pepper grinders; pepper mills; pitchers; plates; pots; pots and pans; salad bowls; salt cellars; spatulas for kitchen use; sprinklers for watering flowers and plants; table plates; thermal insulated bags for food or beverages; thermal insulated containers for food and beverages; vacuum bottles; vases; washing brushes; water bottles

**Application Number** 2,127,507  
**Language of Application** English

**Filing Date** 2021-08-17

## APPLICANT DETAILS

### Applicant

SHENZHEN Y&H E-COMMERCE CO., LTD.  
ROOM 308, 1970 TECH ZONE  
MINZHI, LONGHUA DIST  
SHENZHEN, 518000  
CHINA

## TRADEMARK DETAILS

# Aehdt

### Trademark Type

Standard Characters

### Goods

#### Class 03

(1) aromatic essential oils; aromatic potpourris; artificial fingernails; bar soap; bath gels; beauty creams; beauty soap; cloths impregnated with a detergent for cleaning; cosmetic pencils; cosmetic preparations for eyelashes; cotton sticks for cosmetic purposes; cotton wool buds for cosmetic use; cream soaps; cuticle removing preparations; cuticle removing preparations for cosmetic purposes; decalcomanias for fingernails; depilatories; dishwashing detergents; douching toiletry preparations for personal sanitary and deodorant purposes; dry-cleaning preparations; drying agents for dishwashing machines; eye cream; eyebrow cosmetics; eyeshadow; fabric softeners for laundry use; facial beauty masks; facial cleansers; facial cream; false eyelashes; fingernail decals; floor wax removers; javelle water; laundry bleaching preparations; laundry starch; lip balm; lip cream; lip glosses; lipsticks; liquid perfumes; makeup; nail polish; perfumery; polish for furniture and flooring; shaving balm; shoe cream; shoe polish; toilet bowl detergents; toothpaste; wallpaper cleaning preparations; windscreen cleaning liquids

#### Class 08

(2) baby spoons, table forks and table knives; beard clippers; ceramic knives; crimping iron hand tools; curling tongs; cuticle nippers; ear-piercing apparatus; electric and non-electric depilation appliances; electric fingernail polishers; electric hair clippers; electric hair trimmers; electric hand-held hair styling irons; electric manicure sets; electric nail files; electrolysis apparatus for hair removal; emery boards; eyelash curlers; fruit segmenters; hair clippers for animals being hand instruments; hair-removing tweezers; hand-operated hand tools; hand-operated lifting jacks; hand-operated spanners; hand-operated vegetable shredders; hobby knives; household knives; kitchen mandolines; knives, forks and spoons being tableware; manicure sets; nail clippers; nail files; non-electric can openers; non-electric egg slicers; non-electric fingernail polishers; non-electric hair clippers; paring knives for household use; pedicure sets; pliers; punches being hand tools; razor blades; razor cases; razors; scissors; screwdrivers; sharpening stones; shaving cases; shovels; sterile body piercing instruments; tattoo needles; tattooing needles; tweezers; vegetable peelers

#### Class 21

(3) bamboo place mats; bowls; brooms; cake molds; citrus juicers; coffee scoops; cookery molds; cookery moulds; cooking funnels; cooking utensils; cork place mats; cosmetic brushes; cosmetic spatulas; cups; dishes; dishes and plates; drinking glasses; drinking straws; egg separators; fitted vanity cases; flower pots; food and beverage containers for household use; food storage containers; glass bottles; gloves for household purposes; hand-operated coffee grinders; hand-operated pepper mills; jugs; make-up brushes; make-up sponges; manual egg beaters; mixing spoons; non-electric griddles; oven mitts; painted glassware; pepper grinders; pepper mills; pitchers; plates; pots; pots and pans; salad bowls; salt cellars; spatulas for kitchen use; sprinklers for watering flowers and plants; table plates; thermal insulated bags for food or beverages; thermal insulated containers for food and beverages; vacuum bottles; vases; washing brushes; water bottles

**Application Number** 2,127,508  
**Language of Application** English

**Filing Date** 2021-08-17

## **APPLICANT DETAILS**

**Applicant**  
BRD Traffic Equipment (Kunshan) LTD  
No188,Xijiang Rd,  
Kunshan, 215333  
CHINA

## **TRADEMARK DETAILS**

**Trademark Type**  
Design

### **Visual Representation**

The image shows the word "SEBIC" in a bold, red, italicized sans-serif font. The letters are thick and slanted to the right, with a slight shadow effect behind them, giving it a three-dimensional appearance. The font is a stylized, modern typeface.

### **Colour Claim**

Colour is claimed as a feature of the trademark. The word SEBIC is red.

### **Goods**

#### **Class 12**

bicycle brakes; bicycle chains; bicycle handlebars; bicycle pedals; bicycle saddles; bicycle seats; bicycle tyres; bicycle wheels; bicycles; electric bicycles; electric drives for vehicles; folding bikes; front forks for bicycles; mini-bikes; motor scooters; mountain bicycles; racing bicycles; road racing bicycles; saddle covers for bicycles



**Application Number** 2,127,509  
**Language of Application** English

**Filing Date** 2021-08-17

## APPLICANT AND AGENT DETAILS

### Applicant

Admissions Xiao  
No. 17, Miaonaoshang, Yungang Village,  
Quanjiang Town, Suichuan County,  
Ji'an City, Jiangxi Province,  
CHINA

### Agent

XIN XU  
(Fang An Law PC), Suite 300 & 306, 5500  
North Service Rd., Burlington, ONTARIO,  
L7L6W6

## TRADEMARK DETAILS

# JTJW

### Trademark Type

Standard Characters

### Goods

#### Class 20

(1) bathroom and shaving mirrors; bathroom mirrors; bolsters as cushions; book stands; boxes of wood and plastic; chair cushions; clothes hangers; coat stands; cork stoppers; corks for bottles; costume display stands; costume stands; curtain rings; curtain rods; cushions; cushions filled with hair; decorative pillows; display stands; fishing stools; funerary urns; furniture cushions; furniture flower stands; garden furniture; hand-held mirrors; hat stands; head positioning pillows for babies; head support cushions for babies; head supporting pillows; inflatable furniture; inflatable pillows; kennels; kennels for household pets; kitchen furniture; lawn furniture; life-size forms of the human body to display clothes; living room furniture; massage tables; mattresses; mattresses and pillows; mattresses made of flexible wood; metal shelving; mirror frames; neck-supporting pillows; nesting boxes; office armchairs; office chairs; office furniture; outdoor furniture; patio furniture; pet cushions; picture frames; pillows; plastic clothes hooks; plastic furniture casters; plastic shipping and storage boxes; playpens; playpens for babies; rods for beds; school furniture; seat cushions; shaving mirrors; signboards of wood or plastics; sleeping mats; sofa beds; sofas; spring mattresses; stair rods; stands for calculators; stools; toilet mirrors; tool racks; umbrella stands; window blinds; wooden clothes hooks

#### Class 21

(2) baking mats; bamboo place mats; bread bins; bread-cases for kitchen use; cake brushes; cake decorating tips and tubes; cake domes; cake molds; cake moulds; cake pans; cake rings; cake servers; cake tins; cat litter boxes; chamber pots; cheese graters for household purposes; chopping boards for kitchen use; cinder sifters for household purposes; clothes brushes; coal buckets for household use; cooking pans; cooking pots; cooking strainers; cooking utensils; cork place mats; cosmetic brushes; cosmetic spatulas; crockery; cutting boards; dishes and plates; dishwashing brushes; dispensers for liquid soap for household purposes; drinking straws; droppers for cosmetic purposes; droppers for household purposes; dust bins; dust pans; electric combs; electric hair combs; electric tooth brushes; electric toothbrushes; electrical toothbrushes; exfoliating brushes; eyebrow brushes; eyelash brushes; eyeliner brushes; feather-dusters; floss for dental purposes; flower baskets; flower pot holders; flower pots; food and beverage containers for

household use; food basters; food storage containers; frying pans; furniture dusters; garbage pails; glass bottles; gloves for household purposes; glue pots; hair for brushes; hairbrushes; heads for electric toothbrushes; household scrubbing brushes; ice cube molds; insect traps; jugs; kitchen scrubbing brushes; laundry baskets; laundry baskets for household purposes; lip brushes; make-up brushes; manicure brushes; mouse traps; nail brushes; napkin holders; non-electric cooking pans; non-electric food blenders for household purposes; non-electric frying pans; non-electric toothbrushes; paper and plastic cups; paper cups; paper plates and paper cups; paper towel holders; pastry brushes; pepper pots; pie pans; planters for flowers and plants; plastic bottles; plastic cups; plastic recycling bins for household use; plastic water bottles; plastic water bottles sold empty; plug-in diffusers for mosquito repellents; porcelain eggs; porcelain mugs; pot holders; pots; pots and pans; refuse bins; reusable plastic water bottles sold empty; serving dishes; soap dishes; soap holders; soap holders and boxes; sprinklers for watering flowers and plants; stew-pans; syringes for watering flowers and plants; vacuum bottles; vaporizers for perfume sold empty; washing brushes; waste bins for household use; waste disposal bins; work gloves; works of art made of glass; works of art of porcelain, earthenware and glass

**Application Number** 2,127,510  
**Language of Application** English

**Filing Date** 2021-08-17

## APPLICANT DETAILS

**Applicant**  
Sarabjit Singh  
7950 155 St  
Surrey  
BRITISH COLUMBIA  
V3S3P4

## TRADEMARK DETAILS

**Trademark Type**  
Design

**Visual Representation**



**Goods****Class 25**

A-shirts; adult pajamas; adult sweatpants; ankle socks; athletic apparel; athletic clothing; athletic pants; athletic shirts; athletic shorts; athletic tights; athletic uniforms; babies' pants; babies' underwear; baby bodysuits; baby clothes; baby clothing; baby pants; baseball caps; beach clothes; beach pyjamas; blue jeans; bow ties; casual and athletic clothing; casual clothing; casual clothing featuring pants, dresses and shorts; casual trousers; casual wear; children's clothing; children's shirts; children's wear; clothing for babies; clothing for children; clothing for sports; collared shirts; denim jackets; denim jeans; denim pants; graphic t-shirts; hooded jackets; hooded pullovers; hooded sweatshirts; hooded tops; hoodies; infantwear; jean jackets; jogging pants; knitted shirts; pajama bottoms; sleepwear; sneakers; stretch pants

**Application Number** 2,127,531  
**Language of Application** English

**Filing Date** 2021-08-17

## APPLICANT AND AGENT DETAILS

### Applicant

BEAR RIVER INDIAN BAND d.b.a. BEAR  
RIVER FIRST NATION and L'SITKUK  
MI'KMAW FIRST NATION  
130 Reservation Road  
P.O. Box 210  
Bear River  
NOVA SCOTIA  
B0S1B0

### Agent

STEWART HAYNE  
(COX & PALMER), PO Box 2380 Central,  
Nova Centre - South Tower, 1500 -1625  
Grafton Street, Halifax, NOVA SCOTIA,  
B3J0E8

## TRADEMARK DETAILS

### Trademark Type

Design

### Visual Representation

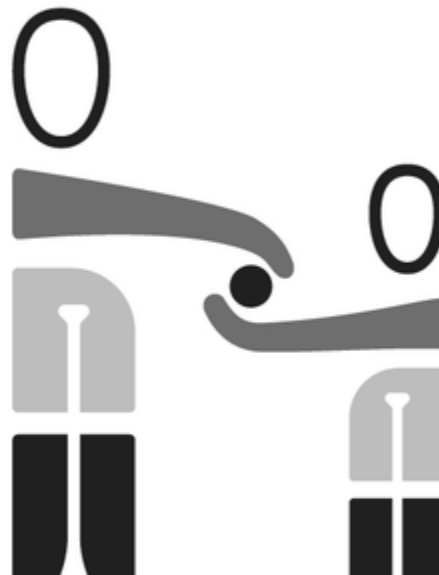



***Seven Paddle***

**Goods**

**Class 29**

(1) beef; chicken; fish; frozen meat; oysters; seafood; shellfish

**Class 30**

(2) honey; maple syrup

**Class 31**

(3) fresh fruit; fresh vegetables

**Application Number** 2,127,715  
**Language of Application** English

**Filing Date** 2021-08-18

## APPLICANT AND AGENT DETAILS

### Applicant

Shanghai zhangda maoyi shanghang  
Room 235 T zone Floor 2 Building 1  
No.3424 Zhufeng Road, Qingpu District  
Shanghai, 201715  
CHINA

### Agent

MILTONS IP/P.I.  
#200-15 Fitzgerald Road, Ottawa, ONTARIO,  
K2H9G1

## TRADEMARK DETAILS

# PONY DANCE

### Trademark Type

Standard Characters

### Goods

#### Class 24

bed and table linen; blankets; curtains; curtains made of textile fabrics; curtains of textile; fabric table runners; indoor and outdoor curtains; pillowcases; shower curtains; table cloth of textile

**Application Number** 2,127,719  
**Language of Application** English

**Filing Date** 2021-08-18

## APPLICANT AND AGENT DETAILS

### Applicant

Shanghai zhangda maoyi shanghang  
Room 235 T zone Floor 2 Building 1  
No.3424 Zhufeng Road, Qingpu District  
Shanghai, 201715  
CHINA

### Agent

MILTONS IP/P.I.  
#200-15 Fitzgerald Road, Ottawa, ONTARIO,  
K2H9G1

## TRADEMARK DETAILS

# PONY DANCE

### Trademark Type

Standard Characters

### Goods

#### Class 27

bath mats; bath rugs; carpets; carpets and rugs; door mats; door mats of textile; floor mats; non-slip mats for baths; rugs; textile bath mats



**Application Number** 2,127,721  
**Language of Application** English

**Filing Date** 2021-08-18

## APPLICANT AND AGENT DETAILS

### Applicant

Shanghai zhangda maoyi shanghang  
Room 235 T zone Floor 2 Building 1  
No.3424 Zhufeng Road, Qingpu District  
Shanghai, 201715  
CHINA

### Agent

MILTONS IP/P.I.  
#200-15 Fitzgerald Road, Ottawa, ONTARIO,  
K2H9G1

## TRADEMARK DETAILS

# PONY DANCE

### Trademark Type

Standard Characters

### Goods

#### Class 20

curtain hooks; curtain rings; curtain rods; curtain tie-backs; cushions; indoor blinds; indoor window shades of textile; interior textile window blinds; mattresses and pillows; pillows

**Application Number** 2,127,783  
**Language of Application** English

**Filing Date** 2021-08-18

## APPLICANT AND AGENT DETAILS

### Applicant

Bestway Inflatables & Material Corp.  
No. 208 Jinyuanwu Road  
Shanghai, 201812  
CHINA

### Agent

DICKINSON WRIGHT LLP  
199 Bay Street, Suite 2200, P.O. Box 447,  
Commerce Court : Postal Station, Toronto,  
ONTARIO, M5L1G4

## TRADEMARK DETAILS

### Trademark Type

Design

### Visual Representation



### Colour Claim

Colour is claimed as a feature of the trademark. The words SWIM and SAFE are presented in yellow with a light blue outline followed by a dark blue outline. The tear drop designs on the left and right are in presented in white with shades of blue. The letter A within the square design is presented in white with the word STEP in yellow all presented on a red background with a dark blue outline followed by a white outline and another dark blue outline. The letter B within the square design is presented in white with the word STEP in yellow all presented on a light blue background with a dark blue outline followed by a white outline and another dark blue outline. The

letter C within the square design is presented in white with the word STEP in yellow all presented on a green background with a dark blue outline followed by a white outline and another dark blue outline.

**Goods****Class 28**

beach balls; inflatable armbands for swimming; inflatable toys; plastic swimming pools; play swimming pools; swim floats for recreational use; swimming belts; swimming boards; swimming fins; swimming flippers; swimming floats; swimming gloves; swimming rings; water toys;

**Application Number** 2,127,861  
**Language of Application** English

**Filing Date** 2021-08-18

## **APPLICANT DETAILS**

### **Applicant**

IoT That Inc.  
306-2255 Atkinson Street  
V2A 8R7  
Penticton  
BRITISH COLUMBIA  
V2A8R7

## **TRADEMARK DETAILS**

### **Trademark Type**

Design

### **Visual Representation**

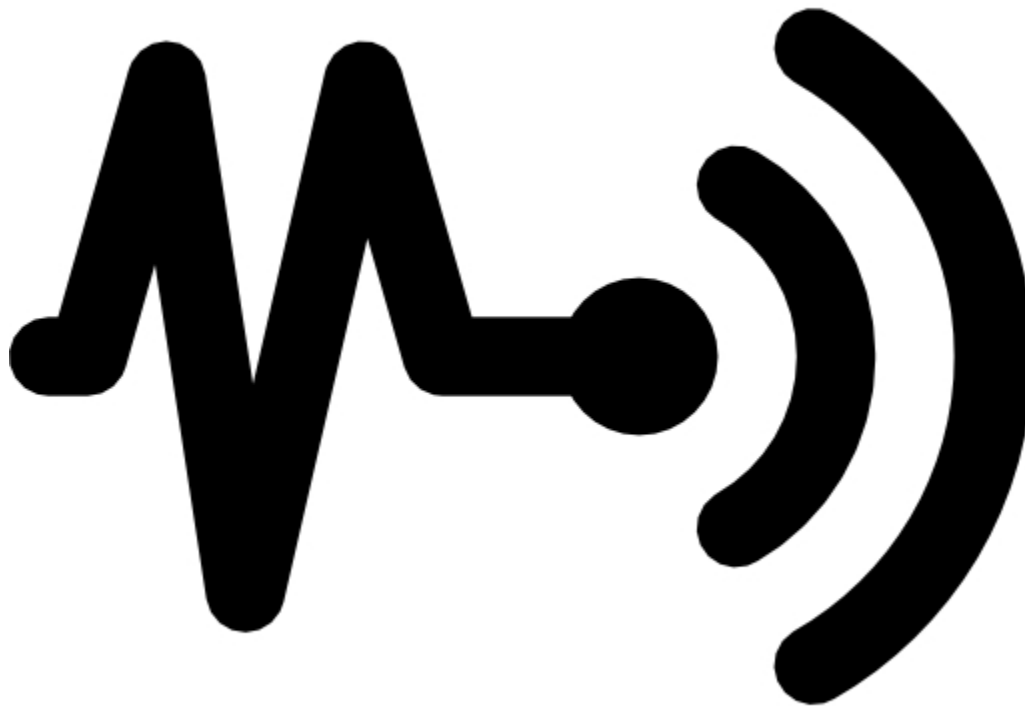

**Services**

**Class 42**

computer hardware and software design

**Application Number** 2,127,868  
**Language of Application** English

**Filing Date** 2021-08-18

## APPLICANT AND AGENT DETAILS

### Applicant

TengHong Lin  
Building 9-2, No.1 Chuangye Road  
Puyan Subdistrict, Binjiang District  
Hangzhou, Zhejiang, 310000  
CHINA

### Agent

NEOMARK LTD.  
7450 rue Saint-Hubert, Montréal, QUEBEC,  
H2R2N3

## TRADEMARK DETAILS

# Suvimuga

### Trademark Type

Standard Characters

### Goods

#### Class 25

bikinis; blouses; bras; casual clothing; coats; dresses; gloves; hats; jackets; jeans; jumpsuits; knit tops; leg warmers; lingerie; loungewear; pants; pullovers; scarfs; shirts; skirts; sleepwear; sports clothing; sweaters; sweatshirts; t-shirts; ties; underwear; vests; woven tops

**Application Number** 2,127,885  
**Language of Application** English

**Filing Date** 2021-08-19

## **APPLICANT DETAILS**

**Applicant**  
HAO YANG  
310 Forest Run Blvd  
Concord  
ONTARIO  
L4K5K1

## **TRADEMARK DETAILS**

**WISOMHOME**

**Trademark Type**  
Standard Characters

**Goods**

**Class 17**

anti-dazzle films for windows; anti-dazzle tinted films for windows

**Application Number** 2,127,891  
**Language of Application** English

**Filing Date** 2021-08-19

## APPLICANT AND AGENT DETAILS

### Applicant

Shanghai zhangda maoyi shanghang  
Room 235 T zone Floor 2 Building 1  
No.3424 Zhufeng Road, Qingpu District  
Shanghai, 201715  
CHINA

### Agent

MILTONS IP/P.I.  
#200-15 Fitzgerald Road, Ottawa, ONTARIO,  
K2H9G1

## TRADEMARK DETAILS

### Trademark Type

Design

### Visual Representation



**PONY DA**

### Goods

#### Class 24

bed and table linen; blankets; curtains; curtains made of textile fabrics; curtains of textile; fabric table runners; indoor and outdoor curtains; pillowcases; shower curtains; table cloth of textile



**Application Number** 2,127,892  
**Language of Application** English

**Filing Date** 2021-08-19

## APPLICANT AND AGENT DETAILS

### Applicant

Shanghai zhangda maoyi shanghang  
Room 235 T zone Floor 2 Building 1  
No.3424 Zhufeng Road, Qingpu District  
Shanghai, 201715  
CHINA

### Agent

MILTONS IP/P.I.  
#200-15 Fitzgerald Road, Ottawa, ONTARIO,  
K2H9G1

## TRADEMARK DETAILS

### Trademark Type

Design

### Visual Representation



**PONY DA**

### Goods

#### Class 27

bath mats; bath rugs; carpets; carpets and rugs; door mats; door mats of textile; floor mats; non-slip mats for baths; rugs; textile bath mats

**Application Number** 2,127,894  
**Language of Application** English

**Filing Date** 2021-08-19

## APPLICANT AND AGENT DETAILS

### Applicant

Shanghai zhangda maoyi shanghang  
Room 235 T zone Floor 2 Building 1  
No.3424 Zhufeng Road, Qingpu District  
Shanghai, 201715  
CHINA

### Agent

MILTONS IP/P.I.  
#200-15 Fitzgerald Road, Ottawa, ONTARIO,  
K2H9G1

## TRADEMARK DETAILS

### Trademark Type

Design

### Visual Representation



**PONY DA**

### Goods

#### Class 20

curtain hooks; curtain rings; curtain rods; curtain tie-backs; cushions; indoor blinds; indoor window shades of textile; interior textile window blinds; mattresses and pillows; pillows

**Application Number** 2,128,087  
**International Registration Number** 1608331  
**Language of Application** French

**Filing Date** 2021-05-26

## APPLICANT AND AGENT DETAILS

### Applicant

BIOTECH DENTAL SMILERS  
305 allée de Craponne  
F-13300 SALON DE PROVENCE  
FRANCE

### Agent

LAVERY, DE BILLY, LLP  
1 Place Ville Marie, Suite 4000, Montréal,  
QUÉBEC, H3B4M4

## TRADEMARK DETAILS

# SMILERS BEAUTY

### Trademark Type

Standard Characters

### Goods

#### Class 03

(1) Oral hygiene preparations, namely tooth whitening preparations, tooth cleaning preparations, anticavity dental and oral rinses other than for medical use; products for tooth whitening, other than for medical use; tooth whitening strips; cosmetic product kits for dental and oral care, namely mouthwash, toothpaste, teeth whitener, non-medicated mouthwash; cosmetics for dental and oral care; tooth cleansing lotions; non-medicinal oral sprays, namely breath-freshening sprays; mouthwashes other than for medical use; non-medicinal toothpastes; whitening toothpastes; tooth cleaning preparations, namely tooth cleansing gels, tooth whitening gels; tooth polishing preparations, tooth polishing products, namely tooth polish.

#### Class 05

(2) Pharmaceutical preparations, namely medicated dental cleansing gels, medicated brush-on oral care gels, teething gels, pharmaceutical antidiabetic preparations, pharmaceutical preparations for reducing cholesterol, anti-inflammatory pharmaceutical preparations, pharmaceutical preparations for the treatment of migraines, veterinary preparations, namely analgesics for veterinary use, veterinary vaccines; pharmaceutical preparations for the treatment of dental and oral diseases, oral hygiene products for medical use, anticavity dental and oral rinses for medical use; sanitary preparations for medical and medical dentistry use, namely hand sanitizers, disinfectants for dental and medical apparatus and instruments; materials for stopping teeth and for dental impressions; amalgams for dental use, dental cements, cements for dental prostheses, dental lacquers, conductive lacquers for dental use, dental mastics, porcelain for dental prostheses; medical oral care products, namely medicated mouthwashes; herbal supplements for the treatment of dental and oral diseases, homeopathic remedies for the treatment of dental and oral diseases, anticavity dental and oral rinses for medical use; medicated toothpastes.

#### Class 10

(3) Medical apparatus and instruments, namely medical X-ray apparatus, phototherapeutic apparatus for medical use, surgical apparatus, namely surgical catheters, surgical perforators,

surgical robots and surgical instruments, dental apparatus, namely X-ray apparatus for dental imaging, veterinary apparatus, namely castrating apparatus for veterinary use, lasers for veterinary use, veterinary operating lamps and veterinary instruments; orthodontic apparatus and multi-attachment apparatus for straightening teeth and treating malocclusions; parts for dental, orthodontic, periodontic, pedodontic, prosthodontic and endodontic apparatus; artificial prostheses, dental prostheses, prosthetic instruments for dental use, implant abutments for dental use, dental implants made of artificial materials, implants for use in oral surgery, implant bridges for dental use; specialized cases for surgical instruments and implants.

## **Services**

### **Class 44**

Dental care services and orthodontic services; tooth whitening services; dental clinic services; cosmetic dentistry; beauty salon services, health and beauty care services provided by saunas, beauty salons, sanatoriums, hairdressing salons and massage parlours; consulting related to dental care and cosmetic dentistry.

## **Claims**

Priority Filing Date: February 10, 2021, Country or Office: EUIPO (EU), Application No: 018396188 in association with the same kind of goods and in association with the same kind of services

**Application Number** 2,128,257  
**Language of Application** English

**Filing Date** 2021-08-19

## **APPLICANT DETAILS**

### **Applicant**

Robert-John Donaldson  
309 Irene Dr.  
2B  
L4P 3A9  
Keswick  
ONTARIO  
L4P3A9

## **TRADEMARK DETAILS**

### **Trademark Type**

Design

### **Visual Representation**



**Colour Claim**

Colour is claimed as a feature of the trademark. Lettering is light blue, half circle fill colour surrounding mascot is black with thin yellow outside line & line under subtitle is yellow. Dog is fawn coloured wearing red cape.

**Services****Class 37**

carpet and rug cleaning; cleaning of buildings

**Application Number** 2,128,311  
**International Registration Number** 1608476  
**Language of Application** English

**Filing Date** 2021-07-13

## APPLICANT AND AGENT DETAILS

### Applicant

JOHNSON ESTATE LIMITED  
37 Lake Timara Road,  
Waihopai Valley  
Blenheim 7276  
NEW ZEALAND

### Agent

BERESKIN & PARR LLP/S.E.N.C.R.L., S.R.L.  
SCOTIA PLAZA, 40 KING STREET WEST,  
40th FLOOR, TORONTO, ONTARIO, M5H3Y2

## TRADEMARK DETAILS

# SATELLITE

**Trademark Type**  
Standard Characters

### Goods

**Class 33**

wine.

**Application Number** 2,128,325  
**International Registration Number** 1320209  
**Language of Application** English

**Filing Date** 2021-07-19

## APPLICANT AND AGENT DETAILS

### Applicant

Ebiquity plc  
Chapter House,  
16 Brunswick Place  
London N1 6DZ  
UNITED KINGDOM

### Agent

RONALD S. ADE LAW CORPORATION  
102 - 1015 Wilkes Avenue, Winnipeg,  
MANITOBA, R3P2R8

## TRADEMARK DETAILS

# FIRM DECISIONS

### Trademark Type

Standard Characters

### Services

#### Class 35

Account auditing; business auditing; business planning; business organization consulting; business management and administration; business management services; advertising and marketing consultancy; business information management; business intelligence services; advertising, marketing and promotional consultancy, advisory and assistance services.



**Application Number** 2,128,388  
**Language of Application** English

**Filing Date** 2021-08-19

## APPLICANT AND AGENT DETAILS

### Applicant

AEM Canada Group Inc./ Groupe AEM Canada  
Inc.  
249-500 Boul Cartier O  
Laval  
QUEBEC  
H7V5B7

### Agent

BERESKIN & PARR LLP/S.E.N.C.R.L., S.R.L.  
SCOTIA PLAZA, 40 KING STREET WEST,  
40th FLOOR, TORONTO, ONTARIO, M5H3Y2

## TRADEMARK DETAILS

# SUPALOX

**Trademark Type**  
Standard Characters

### Goods

**Class 01**

alumina

**Application Number** 2,128,400  
**Language of Application** English

**Filing Date** 2021-08-19

## APPLICANT AND AGENT DETAILS

### Applicant

Stallion Express Inc.  
2-7676 Woodbine Ave  
Markham  
ONTARIO  
L3R2N2

### Agent

JERRY CHEN  
JZC Intellectual Property Law, 166 Berwick  
Cres, Richmond Hill, ONTARIO, L4C0B4

## TRADEMARK DETAILS

# SHIPPSY

### Trademark Type

Standard Characters

### Services

#### Class 39

packaging of articles for transportation; parcel delivery; parcel shipping services; supply chain logistics and reverse logistics services consisting of the delivery of goods for others by air, rail, ship or truck; supply chain logistics and reverse logistics services consisting of the storage of goods for others by air, rail, ship or truck; supply chain logistics and reverse logistics services consisting of the transportation of goods for others by air, rail, ship or truck

**Application Number** 2,128,401  
**Language of Application** English

**Filing Date** 2021-08-19

## APPLICANT AND AGENT DETAILS

### Applicant

Stallion Express Inc.  
2-7676 Woodbine Ave  
Markham  
ONTARIO  
L3R2N2

### Agent

JERRY CHEN  
JZC Intellectual Property Law, 166 Berwick  
Cres, Richmond Hill, ONTARIO, L4C0B4

## TRADEMARK DETAILS

# STALLION EXPRESS

### Trademark Type

Standard Characters

### Services

#### Class 39

packaging of articles for transportation; parcel delivery; parcel shipping services; supply chain logistics and reverse logistics services consisting of the delivery of goods for others by air, rail, ship or truck; supply chain logistics and reverse logistics services consisting of the storage of goods for others by air, rail, ship or truck; supply chain logistics and reverse logistics services consisting of the transportation of goods for others by air, rail, ship or truck

**Application Number** 2,128,408  
**Language of Application** English

**Filing Date** 2021-08-19

## **APPLICANT DETAILS**

### **Applicant**

Tracy Kingston  
437 Lyndock St.  
Corunna  
ONTARIO  
N0N1G0

## **TRADEMARK DETAILS**

# **Kay's Petals & Plants**

**Trademark Type**  
Standard Characters

### **Services**

**Class 35**  
florist shop services

**Application Number** 2,128,415  
**Language of Application** English

**Filing Date** 2021-08-19

## APPLICANT DETAILS

### Applicant

Strive Nutrients Inc.  
30 Tuttle Point Pvt.  
Johnstown  
ONTARIO  
K0E1T1

## TRADEMARK DETAILS

# Veg + Bloom COMPLETE

### Trademark Type

Standard Characters

### Goods

#### Class 01

fertilizer; fertilizers for hydroponics; hydroponic fertilizers; inorganic fertilizers; manganese fertilizer; mixed fertilizers; nitrogenous fertilizers; phosphate fertilizers; potassium fertilizers; synthetic fertilizers for agricultural purposes; urea fertilizers

**Application Number** 2,128,427  
**Language of Application** English

**Filing Date** 2021-08-19

## APPLICANT DETAILS

### Applicant

GDI Grupo Diamante Internacional, S.A. de C.  
V.  
Agustin melgar B6  
Col. Niños Héroes  
Texcoco, México, 56160  
MEXICO

## TRADEMARK DETAILS

### Trademark Type

Design

### Visual Representation



### Goods

#### Class 25

coats; ladies' suits; men's suits; pants; shirts; short pants; skirts; socks; suits; sweaters; t-shirts;  
work shoes and boots

**Application Number** 2,128,440  
**Language of Application** English

**Filing Date** 2021-08-19

## **APPLICANT DETAILS**

### **Applicant**

Think and Tell LLC  
13096 Milltown Rd  
Lovettsville, VA 20180-3504  
UNITED STATES OF AMERICA

## **TRADEMARK DETAILS**

# **GOVERNMENTS**

### **Trademark Type**

Standard Characters

### **Goods**

#### **Class 30**

candy; mints for breath freshening

**Application Number** 2,128,454  
**Language of Application** English

**Filing Date** 2021-08-19

## APPLICANT AND AGENT DETAILS

### Applicant

SUI CHENG LIMITED  
Room 38, 11/F, Meeco Industrial Building, 53-  
55 Au Pui Wan Street  
Fotan, Shatin, N.T.,  
HONG KONG

### Agent

MARK W. TIMMIS  
(MARK TIMMIS LAW CORPORATION), 2595  
CAVENDISH AVENUE, VICTORIA, BRITISH  
COLUMBIA, V8R2G5

## TRADEMARK DETAILS

### Trademark Type

Design

### Visual Representation



**cōmomy**

**Goods**



**Class 20**

bassinets; cradles; dinner wagons being furniture; playpens for babies; tables

**Application Number** 2,128,457  
**Language of Application** English

**Filing Date** 2021-08-19

## APPLICANT AND AGENT DETAILS

### Applicant

Yunnan Dongao cross border e-commerce Co.,  
Ltd  
China (free trade) room 818, block 7  
hailun City Plaza, Guandu District  
Kunming, Yunnan, 650000  
CHINA

### Agent

MILTONS IP/P.I.  
#200-15 Fitzgerald Road, Ottawa, ONTARIO,  
K2H9G1

## TRADEMARK DETAILS

# Ausnutria

### Trademark Type

Standard Characters

### Goods

#### Class 11

electric lights for christmas trees; fairy lights for festive decoration; lamp glasses; nail lamps;  
portable electric fans; portable headlamps; string lights for festive decoration; USB-powered hand  
warmers

**Application Number** 2,128,458  
**Language of Application** English

**Filing Date** 2021-08-20

## APPLICANT DETAILS

### Applicant

Acepic Trading Ltd.  
316 Byng Ave  
North York  
ONTARIO  
M2N4L5

## TRADEMARK DETAILS

# BE&COME

### Trademark Type

Standard Characters

### Goods

#### Class 20

(1) acrylic dividers for tables and desks; adjustable beds; advertising balloons; air mattresses; ambroid bars; ambroid plates; animal claws; animal hooves; animal horns; animal teeth; anti-roll cushions for babies; antlers; arm rests; armchairs; artificial horns; baby changing mats; baby changing platforms; baby changing tables; baby cribs; baby gate mounts of plastic; baby gates; baby walkers; bag hangers of plastic; bakers' bread baskets; bamboo; bamboo baskets for industrial purposes; bamboo curtains; bannetons; banqueting chairs; bar stools; barbers' chairs; barrels and casks for industrial packaging; barstools; bassinets; bassinettes; bath seats for babies; bathroom and shaving mirrors; bathroom furniture; bathroom mirrors; bead curtains for decoration; bean bags; bed bases; bed frames; bed mattresses; bed rails; bedroom furniture; bedroom furniture parts; beds; beds for household pets; bedsprings; bedsteads of wood; beehives; billiard cue racks; birdhouses; blank non-magnetic plastic key cards; blinds of reed, rattan or bamboo (sudare); bolsters; bolsters as cushions; book cases; book holders; book stands; bookcases; bookrests; bookshelves; booster seats; bottle casings of wood; bottle racks; box springs; boxes of wood and plastic; boxes of wood or plastic; bread proofing baskets; brush mountings; buddhist family altars (butsudan); bulletin boards; bumper guards for furniture; bunk beds; cabinet work; cabinets for display purposes; camping furniture; camping mattresses; carpet coasters; carvings; caskets; casks of wood for decanting wine; cat scratching posts; ceramic door knockers; chair beds; chair cushions; chair pads; chairs; chaise lounges; chests for toys; chests of drawers; cheval glasses; childrens' sleeping mats; china cabinets; chopping blocks; clips of plastic for sealing bags; clothes hangers; coat hangers; coat racks; coat stands; coatstands; coffee tables; coffins; comb foundations for beehives; compost bins; computer furniture; computer furniture parts; console tables; cookbook holders; coral; cork furniture knobs; cork stoppers; corks for bottles; corozo; costume display stands; costume stands; cots; cots for babies; cotters; cradles; cribs; cribs for babies; cupboards; cupboards for tea-things cabinets [chadansu]; curtain hooks; curtain rails; curtain rings; curtain rods; curtain rollers; curtain tie-backs; cushions; cushions filled with hair; deck chairs; decorations of plastic for foodstuffs; decorative bead curtains; decorative glitter; decorative mobiles; decorative pillows; decorative wall plaques; desks; diaper changing stations; dining chairs; dining room furniture; dining room furniture parts; dining tables; dinner wagons being

furniture; display boards; display cases; display cases for merchandise; display counters; display racks; display stands; display tables; divans; dog kennels; doors for furniture; drafting table; drafting tables; drawer dividers; drawers that are furniture parts; dreamcatchers; dressers; dressing tables; dressmaker's dummies; dressmakers' dummies; easy chairs; easy-chairs; edgings of plastic for furniture; embroidery frames; end tables; fence gate latches, not of metal; figures made of rattan; filing cabinets; fireguards; fireplace screens; firescreens; fishing baskets; fishing stools; fixed napkin dispensers of plastic; fixed nonmetallic towel dispensers; floor display units; flower-pot pedestals; fodder racks; folding beds; folding chairs; folding seats; folding shelves; folding tables; food hampers; foot stools; footrests; footstools; freestanding furniture partitions; funerary caskets; funerary urns; furniture benches; furniture buffets; furniture cabinets; furniture chests; furniture coasters; furniture cushions; furniture doors; furniture flower stands; furniture for camping; furniture partitions; furniture partitions of wood; furniture screens; furniture shelves; garden furniture; glass door fittings; glass for use in framing art; gun racks; gymnasium dividers; hairdresser's chairs; hairdressers' chairs; hand fans; hand-held flagpoles of fibreglass; hand-held flagpoles of wood; hand-held flat fans; hand-held folding fans; hand-held mirrors; hat racks; hat stands; head positioning pillows for babies; head support cushions for babies; head supporting pillows; high chairs; high chairs for babies; hive boxes or honeycombs; honeycombs; hospital beds; household shinto altars [kamidana]; imitation cork stoppers; imitation foods comprised of plastic; imitation tortoiseshell; indoor benches being household furniture; indoor blinds; indoor window blinds; indoor window shades of paper; indoor window shades of textile; indoor window shades of woven wood; industrial packaging containers of bamboo; industrial packaging containers of wood; industrial water tanks; infant beds; infant cradles; infant walkers; inflatable furniture; inflatable neck support cushions; inflatable pillows; inflatable publicity mascots; interior textile window blinds; internal venetian blinds; Japanese floor cushions [zabuton]; Japanese food wrapping sheets of wood [kyogi]; Japanese style arm rests (kyosoku); Japanese style floor seats (zaisu); Japanese style low desks (wazukue); Japanese style low tables (zataku); jerrycans of plastic; jewellery organizer display stands; kennels; kennels for household pets; kimono racks; kindling boxes; kitchen cabinets; kitchen furniture; labels of plastic; ladders of wood or plastics; lap desks; lawn furniture; lawn furniture parts; lecterns; letter boxes of plastic; letter boxes of plastic and wood; letter boxes of wood; library shelves; life-size forms of the human body to display clothes; living room furniture; living room furniture parts; lockers; looking glasses; lounge chairs; lounge chairs for cosmetic treatments; magazine racks; mannequins; massage chairs; massage tables; mats for infant playpens; mattress toppers; mattresses; mattresses and pillows; mattresses made of flexible wood; meat safes; meat safes of metal; mechanical ceramic door bells; medicine cabinets; meerscham; metal cabinets; metal camping furniture; metal furniture for camping; metal indoor window blinds; metal interior roller blinds for guiding light; metal shelving; metal storage cabinets; metal tool cabinets; metal vice benches being furniture; mirror frames; mirror tiles; mirrored cabinets; mirrors; moldings for picture frames; moses baskets; mother of pearl; mouldings for picture frames; movable office partitions; nagamochi chests; nameplates; neck support cushions; neck-supporting pillows; nesting boxes; nesting boxes for animals; nesting boxes for household pets; newspaper display stands; night tables; non-electric fans for personal use; non-metal binding screws for cables; non-metal door bolts; non-metal door handles; non-metal door nameplates; non-metal fastener bolts; non-metal fastener nuts; non-metal fastener screws; non-metal hardware bolts; non-metal hardware nuts; non-metal hardware screws; non-metal nameplates; non-metal screws; non-metal vats; non-metallic bottle caps; non-metallic bottle closures; non-metallic bottle stoppers; non-metallic dowels; non-metallic vats; occasional tables; office armchairs; office chairs; office desks; office furniture; office tables; oriental folding partition screens [byoubu]; oriental single panel standing partition [tsuitate]; ottomans; outdoor furniture; outdoor furniture parts; oyster shells; packaging containers of plastic; park benches; partitions of

wood for furniture; partly worked tortoiseshells; partly-worked reeds; patio furniture; patio furniture parts; pet beds; pet crates; pet cushions; pet furniture; pet gates; piano benches; picture and photograph frames; picture frame brackets; picture frame moldings; picture frames; pillows; placards of wood or plastics; plaster busts; plastic angle valves for kitchen sinks; plastic brackets for furniture; plastic busts; plastic cable clamps; plastic clothes hooks; plastic coathooks; plastic coffin fittings; plastic dividers for use with tables and desks; plastic door latches; plastic furniture casters; plastic furniture for gardens; plastic garden stakes; plastic hat hooks; plastic hinges; plastic keys; plastic labels; plastic latches; plastic ramps for use with vehicles; plastic recycling bins for commercial use; plastic rivets; plastic screw tops for bottles; plastic sculptures; plastic shipping and storage boxes; plastic stakes for plants or trees; plastic storage bins; plastic storage totes; plastic tool boxes sold empty; plate racks; playpens; playpens for babies; point-of-purchase display racks; polyethylene liquid storage tanks for industrial purposes; porcelain doorknobs; porch swings; portable desks; pulleys of plastics for blinds; PVC garden stakes; rattan; raw or partly worked meerschaum; raw or partly worked onigaya hay; raw or partly worked rattan; raw or partly worked tusks; reclining armchairs; reclining chairs; resin figurines; rice chests; rocking chairs; rods for beds; room dividers; sales counters; saw benches being furniture; saw horses; sawhorses; school furniture; scratching posts for cats; screens as partitions; screens of reed or substitutes for reed; sea shells; seat cushions; sections of wood for beehives; serving trolleys; settees; shaving mirrors; shelves; shelves for books; shelves for file cabinets; shelves for storage; shelves for typewriters; shelving; shelving units; shipping crates; shoe cabinets; shoe dowels of plastic; shoe pegs of plastic; shoe racks; shower chairs; shower curtain hooks; shower seats; showshelves; side tables; sideboards; signboards of wood or plastics; sink liners; slanted shelves; slatted indoor blinds; slatted shelves; sleeping bag pads; sleeping mats; sleeping pads; sock sorters; sofa beds; sofas; spring mattresses; stag antlers; stair rods; standing desks; stands for calculators; statues of bone; statues of ivory; statues of plaster; staves of wood; stools; stoppers of cork; stoppers of cork and cork imitations; storage closets; storage racks; straw edgings; straw mattress; straw mattresses; straw plaits; stuffed animals; stuffed birds; table leaves; table tops; tables; tailors' dummies; tea carts; tea cupboards [chadansu]; tea tables; tea trolleys; three-mirror dressing tables; toilet mirrors; tool racks; tortoiseshell; tortoiseshells; towel dispensers; towel racks; towel racks and towel holders; toy boxes and chests; toy chests; tray tables; trestle tables; typing desks; umbrella stands; unworked and partly worked animal bone; unworked and semi-worked horn; unworked or partly worked coral; unworked or partly worked ivory; unworked or partly worked material shells; unworked reeds; unworked tortoiseshell; upright signboards of wood or plastics; valet stands; vertical blinds; wall units; wardrobes; water beds; water-pipe valves of plastic; wax busts; wax figurines; whalebones; wheel chocks not of metal; wickerwork; wind chimes; window blinds; window shades; wine racks; wood barrels; wood bedsteads; wood busts; wood carvings; wood ribbon; wooden beds; wooden boxes; wooden boxes for industrial packaging purposes; wooden clothes hooks; wooden door knockers; wooden hat hooks; wooden ice cream sticks; wooden loading pallets; wooden pallets; wooden step ladders; wooden step stools; wooden stoppers for industrial packaging containers; work benches; workbenches; works of art of nutshell; writing desks; writing tables; yellow amber

#### **Class 24**

(2) adhesive fabric for application by heat; afghans; arras; baby blankets; baby buntings; baize; ballistic fabrics for use in the production of bullet-proof and blast-proof clothing, shoes and shields; banners and flags of textile; banners made of textile; banners of textile; banners of textile and plastic; banners of textile or plastic; bath linen; bath mitts; bath sheets; bath towels; bathroom towels of textile; beach towels; bean bag covers; bed and table linen; bed blankets; bed blankets made of cotton; bed blankets made of man-made fibres; bed blankets made of wool; bed

canopies; bed covers; bed covers of paper; bed linen; bed linen of paper; bed pads; bed quilts; bed sheet sets; bed sheets; bed sheets for children; bed sheets of paper; bed skirts; bed spreads; bed throws; bed valances; bedsheets; bedspreads; billiard cloth; bivouac sacks being covers for sleeping bags; blanket throws; blankets; blankets for babies; blankets for children; blankets for household pets; blankets for outdoor use; bolting cloth; box spring covers; brocade; brocade flags; brocades; buckram; bullet-resistant fabrics for use in the production of bullet-proof and blast-proof clothing, shoes and shields; bunting bags; bunting cloth; bunting of textile and plastic; bunting of textile or plastic; burping cloths; cake toppers made of fabric; calico; canvas for embroidery; canvas for tapestry; canvas for tapestry or embroidery; cheese cloth; chemical fiber base mixed fabrics; chemical fiber fabrics; chemical fibre fabrics; chenille fabric; cheviot fabric; children's bed linen; children's bed sheets; children's blankets; children's pillow cases; children's towels; cloth banners; cloth bunting; cloth coasters; cloth doilies; cloth flags; cloth for edging tatami mats; cloth for tatami mat edging ribbons; cloth labels; cloth napkins for removing make-up; cloth pennants; cloth towels; cloths for removing make-up; coasters of textile; comforters; continental quilts; contour sheets; contoured mattress covers; cot canopies; cotton base mixed fabrics; cotton cloth; cotton fabric; cotton fabrics; cotton face towels; cotton hand towels; cotton towels; covered rubber yarn fabrics for textile use; coverings of plastic for furniture; coverlets; covers for cushions; covers for duvets; covers for eiderdowns; covers for futon quilts; covers for quilts; covers of textile for toilet lids; covers of textile for toilet seats; craft felt; crepe cloth; crepon; crib canopies; crib sheets; curtain fabric; curtain fabrics; curtain holders of textile material; curtain loops of textile material; curtains; curtains made of textile fabrics; curtains of plastic; curtains of textile; cushion covers; decorative wall hangings of textile; denim fabric; diaper changing cloths for babies; dimity; dining linens of textile; dish towels for drying; disposable bedding of paper; disposable bedding of textile; down quilts; drapery; drapery curtains; drapes; drugget; dust ruffles; duvet covers; duvets; eiderdown covers; eiderdown quilts; elastic fabrics for clothing; elastic yarn mixed fabrics; esparto fabric; fabric bed valances; fabric boxes for storing greeting cards; fabric flags; fabric for boots and shoes; fabric for embroidery; fabric for footwear; fabric of imitation animal skins; fabric party favour boxes; fabric place mats; fabric table runners; fabric table toppers; fabric valances; fabric valances for beds; fabrics for footwear; fabrics for horticultural use; fabrics for textile use; fabrics impervious to gases; fabrics made of synthetic materials; face cloths; face towels made of cotton; face towels made of textile materials; face towels of textile; face towels of textiles; felt and non-woven textile fabrics; felt cloth; felt filtration media for waste water treatment; felt for door seals; felt pennants; fiberglass fabrics for textile use; fibreglass fabrics for textile use; fireproof upholstery fabrics; fitted bed sheets for pets; fitted mattress covers; fitted sheets; fitted sheets for pet beds; fitted toilet lid covers made of fabric substitutes; fitted toilet lid covers of fabric; fitted toilet seat covers of textile; flags and pennants of textile; flags made of textile; flags of textile; flags of textile and plastic; flags of textile or plastic; flannel; flax cloth; flax fabrics; fleece blankets; frieze cloth; fukusa [Japanese ceremonial wrapping cloth]; furnishing and upholstery fabrics; furnishing fabrics; furniture coverings made of plastic materials; furniture coverings of plastic; furniture coverings of textile; furniture throws; furoshiki [Japanese general purpose wrapping cloth]; furoshiki [Japanese general wrapping cloth]; fustian; futon quilt covers; futon quilts; gabardine; garment lining; gauze fabric; gift wrap of fabric; gift wrap of textile; glass fibre fabrics; golf towels; gummed waterproof cloth; haircloth; hand spun silk fabrics; hand towels; hand towels made of cotton; hand towels made of textile materials; hand towels of cotton; hand towels of textile; hand-spun silk fabrics; hand-towels made of textile fabrics; handkerchiefs; handkerchiefs made of textile; handkerchiefs of textile; hard rubber; heat-activated adhesive fabrics; hemp base mixed fabrics; hemp based mixed fabrics; hemp cloth; hemp fabric; hemp yarn fabrics; hemp-cotton mixed fabrics; hemp-silk mixed fabrics; hemp-wool mixed fabrics; hooded towels; hooded towels for babies; hooded towels for children; imitation animal skin fabrics; individual place mats made of textile; indoor and outdoor curtains;

infants' bed linen; inorganic fiber mixed fabrics; insect netting; insect protection nets; insect protection nets for household purposes; insecticide-treated mosquito nets; iron-on cloth labels; Japanese ceremonial wrapping cloth [Fukusa]; Japanese cotton towels [tenugui]; Japanese general wrapping cloth [Furoshiki]; jersey fabrics for clothing; jute cloth; jute fabric; jute fabrics; kakebuton [futon quilts]; kitchen linen; kitchen towels of textile; kits comprised of fabrics for making quilts; knit fabrics; knitted fabrics; knitted fabrics of chemical fibre yarn; knitted fabrics of chemical-fiber yarn; knitted fabrics of cotton yarn; knitted fabrics of silk yarn; knitted fabrics of wool yarn; Korean-style duvets; labels of cloth; labels of textile; labels of textile for bar codes; labels of textile for identifying clothing; lap blankets; lap robes; lap rugs; lap-ropes; large bath towels; linen cloth; linen fabric for embroidery; linen fabrics; linen for household purposes; linen lining fabric for shoes; lingerie fabric; lining fabric for footwear; lining fabric for shoes; make-up remover napkins; mattress covers; mesh-woven fabrics; metal fiber fabrics; metal fibre fabrics; microfiber towels; microfibre towels; mixed fiber fabrics; mixed fibre fabrics; moleskin fabric; moleskin fabrics for textile use; mosquito nets; muslin fabric; nap raised cloth; narrow woven fabrics; narrow-woven fabrics; net curtains; non-woven fabrics; non-woven fabrics and felts; non-woven textile fabrics; nylon fabric; nylon flags; oil cloth; oil cloths; oilcloth; oilcloth for use as tablecloths; paper bed covers; paper pillowcases; paper yarn fabrics for textile use; pashmina fabrics; pennants of textile; pet blankets; picnic blankets; pillow cases; pillow covers; pillow protectors; pillow shams; pillow slips; pillowcases; place mats of textile; place mats of textile material; plastic banners; plastic bunting; plastic flags; plastic handkerchiefs; plastic pennants; plastic table linens; polyester fabric; press felt; printed calico cloth; printed fabrics; printers' blankets of textile; quilt covers; quilted blankets; quilts; quilts filled with down; quilts of textile; quilts of towel; rags for paper making; ramie fabric; ramie fabrics; rayon fabric; receiving blankets; reed placemats; regenerated fiber yarn fabrics; regenerated fibre yarn fabrics; rubberized cloth; rubberized cloths; sackcloth; sailcloth; sanitary flannel; satin; satin fabrics; self-adhesive cloth labels; semi-synthetic fiber fabrics; semi-synthetic fibre fabrics; serviettes of textile; shams; sheets; sheets for cribs; shower curtains; shower room curtains; shrouds; silk base mixed fabrics; silk bed blankets; silk blankets; silk canvas for embroidery; silk cloth; silk cotton; silk fabric; silk fabrics; silk fabrics for printing patterns; silk-cotton mixed fabrics; silk-wool mixed fabrics; sleeping bag liners; sleeping bags; sleeping bags for babies; sleeping bags for camping; slumber bags; small curtains made of textile materials; spun silk fabrics; stage curtains; swaddling blankets; swag; synthetic fiber fabrics; synthetic fibre fabrics; table and bed linen; table cloth of textile; table cloths of textile; table covers; table linen; table linen of textile; table napkins of textile; table runners; table runners of textile; tablecloth of textile; tablecloths; tablecloths of textile; tablemats of textile; taffeta fabric; tank covers; tapestries; tea towels; tenugui [Japanese cotton towels]; terry towels; textile banners; textile coasters; textile fabric of animal skins imitations; textile fabric of imitation animal skins; textile fabrics; textile fabrics for lingerie; textile fabrics for the manufacture of clothing; textile fabrics for use in the manufacture of bedding; textile face towels; textile flags; textile hand towels; textile handkerchiefs; textile label; textile labels; textile linings for garments; textile napkins; textile place mats; textile printers' blankets; textile quilts; textile substitute materials made from synthetic materials; textile tablecloths; textile used as lining for clothing; textile wall hangings; textiles for carpets; textiles for clothes; textiles for footwear; textiles for furniture; textiles for tires; thick drop curtains; throws; throws for traveling; ticking fabric; toilet seat covers of textile; towelling coverlets; towels for children; towels for use in salons and barber shops; towels made of textile materials; towels of textile; towels of textile featuring American football team logos; traced cloth for embroidery; traced cloths for embroidery; travel blankets; travel rugs; travelling rugs; tricot quilts; true hemp fabrics; tulle; Turkish towels; unfitted fabric crib rail covers; unfitted fabric furniture covers; unfitted fabric slipcovers for furniture; upholstery fabrics; valance sheets; valanced bed covers; valanced bed sheets; valances; velvet; velvet fabric; vinyl curtains; vinyl place mats; voile fabric; waffle towels;

wall hangings of textile; wash cloths; washcloths; washing gloves; washing mitts; waste cotton fabrics; window curtains; wool base mixed fabrics; wool yarn fabrics; wool-cotton mixed fabrics; woolen blankets; woolen cloth; woolen fabric; woollen blankets; woollen cloth; woollen fabric; woollen fabrics; worsted fabrics; woven fabrics; woven fabrics and knitted fabrics; woven felt; zephyr fabric



**Application Number** 2,128,472  
**Language of Application** English

**Filing Date** 2021-08-20

## APPLICANT AND AGENT DETAILS

### Applicant

Haijun Luo  
No. 23, Zhoushang, Fishery Village, Quanjian  
Town, Suichuan County,  
Ji'an City, Jiangxi Province, 518000  
CHINA

### Agent

XIN XU  
(Fang An Law PC), Suite 300 & 306, 5500  
North Service Rd., Burlington, ONTARIO,  
L7L6W6

## TRADEMARK DETAILS

# HROAG

### Trademark Type

Standard Characters

### Goods

#### Class 09

(1) adapter plugs; anti-glare filters for computer monitors; anti-glare filters for televisions and computer monitors; arm rests for use with computers; augmented reality computer games for use on cellular phones; augmented reality computer games for use on mobile phones; augmented reality computer games for use on notebook computers; augmented reality computer games for use on personal computers; augmented reality computer games for use on smart phones; augmented reality computer games for use on tablet computers; augmented reality software for playing computer games; automatic altitude indicators; automatic answering machines; automatic cash dispensers; automatic cash registers; automatic cash sorting and counting machines; automatic chromatography apparatus for laboratory use; automatic controllers for revolving doors; automatic indicators of low pressure in tires; automatic indicators of low pressure in tyres; automatic indicators of low pressure in vehicle tires; automatic indicators of low pressure in vehicle tyres; automatic ion-exchange chromatography apparatus for laboratory use; automatic money counting and money changing machines; automatic solar tracking sensors; batteries and battery chargers for notebook computers; blank computer discs; blank discs for computers; blank floppy computer discs; blank hard disks for computers; blank USB flash drives; cameras; car antennas; car navigation computers; car videorecorders; carbon dioxide detectors; carbon monoxide detectors; card readers for magnetically encoded cards; carrying cases adapted for computers; carrying cases for notebook computers; carrying cases specially adapted for computer printers; cases adapted for computers; cases adapted for netbook computers; cases adapted for notebook computers; cases for smartphones; cases for tablet computers; CD cases; CD drives for computers; CD-ROMs containing computer games; cell phone antennas; cheque encoding machines; clock generators for computers; communications computers; compact disc drives for computers; compact discs containing computer games; computer accelerator boards; computer anti-virus software; computer application software for handheld computers that allows users to access and browse online profiles of pet care service providers; computer application software for mobile phones for use in database management; computer application software for mobile phones that allows users to access and browse online profiles of pet care service providers; computer application software for tablet devices that allows users to access and browse online profiles of pet

care service providers; computer application software in playing video and computer games; computer bags; computer buffers; computer cables; computer card adapters; computer carrying cases; computer cases; computer central processing units; computer chassis; computer chips; computer chipsets for use in transmitting data to and from a central processing unit; computer communications software to allow customers to access bank account information and transact bank business; computer daughterboards; computer disc drives; computer disk/disc drives; computer display monitors; computer display screens; computer e-commerce software to allow users to perform electronic business transactions via a global computer network; computer expansion boards; computer fax modem cards; computer fingerprint imaging software; computer fingerprint scanning software; computer game cartridges; computer game cartridges and discs; computer game cassettes; computer game programmes; computer game programs; computer game software; computer game software for game machines; computer game software for playing online betting games; computer game software for playing online casino games; computer game software for playing online gambling games; computer game software for playing online games of skill; computer game software for playing online prize games; computer game software for use on cellular phones; computer game software for use on mobile phones; computer game tapes; computer games; computer games downloadable from a global computer network; computer games for use on gaming machines; computer games for use on mobile and cellular phones; computer games for use on notebook computers; computer games for use on personal computers; computer games for use on slot machines; computer games for use on tablet computers; computer games for use on video lottery terminals; computer games in the field of basketball; computer graphics boards; computer graphics cards; computer hardware; computer hardware and computer software for database management; computer hardware and software for database management; computer hardware and software for setting up and configuring local area networks; computer hardware for data processing; computer hardware for network access servers; computer hardware for telecommunications; computer heat sinks; computer interface boards; computer interface cards; computer joysticks; computer keyboards; computer keypads; computer memory expansion modules; computer mice; computer monitor frames; computer monitors; computer motherboards; computer motherboards and daughterboards; computer mouse; computer mouse mats; computer mouse pads; computer network adapters; computer network adaptors; computer network bridges; computer network hubs; computer network hubs, switches and routers; computer network routers; computer network server; computer network switches; computer network-attached storage [NAS] hardware; computer networking hardware; computer operating programmes; computer operating programs; computer operating recorded programs; computer operating system software; computer operating systems; computer parallel ports; computer power supplies; computer printers; computer programmes for document management; computer programs (cad/cam) recorded on software designed for use in construction and automated manufacturing; computer programs and computer software for electronic trading of securities; computer programs and software for image processing; computer programs featuring badges for use in online virtual worlds; computer programs featuring characters for use in online virtual worlds; computer programs featuring clothes and accessories for use in online virtual worlds; computer programs featuring emojis for use in online virtual worlds; computer programs featuring stickers for use in online virtual worlds; computer programs for connecting to remote computers and computer networks; computer programs for editing images, sound and video; computer programs for language translations and training; computer programs for network management; computer programs for processing digital music files; computer programs for searching remotely for content on computers and computer networks; computer programs for searching the contents of computers and computer networks by remote control; computer programs for use in electronic commerce for processing electronic payments and authenticating the identity of payers; computer programs for using the Internet and

the World Wide Web; computer programs used for electronic cash register systems; computer scanners; computer screen filters; computer screen saver software; computer screen saver software, recorded or downloadable; computer screens; computer screensaver software; computer search engine software; computer serial ports; computer servers; computer skins, namely, fitted plastic film for covering and providing a scratch proof barrier for computers; computer software and databases for use in diagnosis, repair and configuration of computers; computer software and firmware for playing games of chance on dedicated gaming consoles; computer software and firmware for playing games of chance on reel based slot machines; computer software and firmware for playing games of chance on video based slot machines; computer software and firmware for playing games of chance on video lottery terminals; computer software featuring mathematical algorithms and indices for use in analyzing and evaluating dairy cow health and productivity; computer software for accessing, browsing and searching online databases; computer software for administering employee payroll; computer software for administration of computer local area networks; computer software for application and database integration; computer software for assisting developers in creating program code for use in mobile internet applications and client interfaces; computer software for assisting developers in creating program code for use in multiple application programs; computer software for authorising access to databases; computer software for computer-aided design/computer-aided manufacturing [CAD/CAM]; computer software for contact tracing and tracking of COVID-19 and other infectious diseases; computer software for controlling and managing access server applications; computer software for controlling and managing patient medical information; computer software for controlling and operating laser rangefinders; computer software for converting document images into electronic formats; computer software for creating and editing music; computer software for creating and editing music and sounds; computer software for creating and inserting metatags into documents and information; computer software for creating computer games; computer software for creating searchable databases; computer software for creating searchable databases of information and data; computer software for creating video games; computer software for creating, sending and receiving e-mail; computer software for data deduplication; computer software for data security; computer software for database management; computer software for digital animation and special effects of images; computer software for displaying orders and driver locations on maps; computer software for document management; computer software for editing images, sound, and video; computer software for editing music and for editing digital audio recordings; computer software for fingerprint imaging; computer software for fingerprint scanning; computer software for global positioning systems; computer software for graphic designing and editing; computer software for image processing; computer software for inventory management; computer software for language training; computer software for language translations; computer software for logistics, namely, software for tracking documents, packages and freight; computer software for managing retail store customer accounts; computer software for mathematical calculation; computer software for medical imaging; computer software for monitoring computer network access and activity; computer software for oil and gas reservoir analysis; computer software for operating computer games on the internet; computer software for operating system programs; computer software for optical character recognition; computer software for organising food recipes, monitoring calorie intake, and weigh control; computer software for organizing and viewing digital images and photographs; computer software for predictive and corrective text entry for use with smart phones, tablet computers and personal digital assistants; computer software for processing digital images; computer software for processing digital music files; computer software for project management; computer software for providing an on-line database in the field of transaction processing to upload transactional data, provide statistical analysis, and produce notifications and reports; computer software for running computer games on the internet; computer software for running development

programs and application programs in a common development environment; computer software for scanning, digitizing, altering and retouching of photographs; computer software for text editing; computer software for the collection of statistical production data for oil and gas field operations; computer software for the creation of firewalls; computer software for two or three-dimensional simulation for use in design and development of industrial products; computer software for use as a spreadsheet; computer software for use in cancer diagnosis; computer software for use in controlling and improving computer processing speed; computer software for use in creating and designing web sites; computer software for use in database management; computer software for use in generating streaming advertisements on the web sites of others; computer software for use in managing and controlling production schedules, shipping schedules, purchase of materials, inventories and accounts; computer software for use in processing semiconductor wafers; computer software for use in programming facsimile machines; computer software for use in providing multiple user access to a global computer information network; computer software for use in the encryption and decryption of digital files; computer software for use in the management of payroll; computer software for validating address and zone information; computer software for video editing; computer software for visual art designing and editing; computer software for word processing; computer software that allows transmission of graphics to mobile telephones; computer software that provides real-time, integrated business management intelligence by combining information from various databases; computer software to allow users to perform electronic payment transactions; computer software to automate data warehousing; computer software to calculate and charge sales tax and to create reports to pay sales tax to appropriate tax agencies; computer software to create and manage budgets; computer software to create price quote estimates and transfer price quote estimates to invoices; contact lenses; covers for tablet computers; credit card encoding machines; desktop computers; dish aerials; door chimes; DVD burners; DVD cases; DVD drives; DVD players; DVD recorders; DVD sleeves; DVDs containing instruction manuals in welding; DVDs containing movie recordings; DVDs containing recordings of television shows and movies; electric batteries for cameras; electric batteries for portable computers; electric batteries for powering electric vehicles; electric batteries for smartphones; electric batteries for tablet computers; electric batteries for vehicles; electric batteries for watches; electric buzzers; electric cable connectors; electric cables; electric door chimes; electronic ballasts for lamps; electronic door locks; electronic lock assemblies; electronic sensors for measuring solar radiation; encoded bank cards; encoded bar code labels; encoded credit cards; encoded debit cards; encoded electronic chip cards for identifying particular users of computers and cell phones; encoded electronic chip cards for identifying particular users of computers and mobile phones; encoded gift cards; encoded identity cards; encoded key cards; encoded key cards, namely, encoded identity cards, identification cards with embedded chips, identification smart cards; encoded magnetic identification bracelets; encoded prepaid credit cards; eyeglass mountings; flash lamps for cameras; flash lamps for photography; fuel level indicators for vehicles; head mounted audio-visual display units containing integrated cameras and sensors; head mounted displays; headsets; helmet camera mounts; infrared sensors; integrated circuit modules; keyboards for cellular telephones; keyboards for computers; lanyards for holding encoded identity cards; laser diode modules; lcd monitors; LED displays; led monitors; LED position sensors; lens filters for cameras; light-emitting diode [LED] microscopes; light-emitting diode [LED] monitors; light-emitting diode [LED] televisions; light-emitting diodes [LED]; liquid crystal display (LCD) televisions; liquid crystal display monitors; liquid level sensors; long distance telephone calling cards, magnetically encoded; loud speakers; magnetic encoded card readers; magnetic encoded identification bracelets; magnetic mount flashing safety lights for vehicles; magnetically encoded bank cards; magnetically encoded card readers; magnetically encoded credit cards; magnetically encoded debit cards; magnetically encoded gift cards; magnetically encoded hotel room key cards;

magnetically encoded identification bracelets; magnetically encoded identification cards; magnetically encoded phone cards; metal detectors; mobile phone chargers; motion detectors; motion sensors; motion sensors for security lights; mounting racks adapted for computer hardware; mounting racks for computer hardware; mounts for helmet cameras; mounts for smartphones; oil level indicators for vehicles; oil level sensors; optical sensors; phase indicators; photovoltaic cells and modules; photovoltaic modules; pince-nez mountings; pollutant sensors; pre-paid telephone calling cards, magnetically encoded; pressure sensors; protective cases for smartphones; protective face-shields for protective helmets; proximity sensors; radio aerials; radio antennas; radio signal antennas; rectifier modules; satellite aerials; sensors for determining acceleration; sensors for determining temperature; sensors for determining velocity; slide film mounts; smartphone mounts; speaker mounting brackets; subscriber identification module (SIM) card; tablet computers; television aerials; temperature sensors; thermal sensors; timing sensors; USB cables; USB chargers; USB flash drives; velocity sensors; vibration sensors for installation in wind mill housings; vibration sensors for installation in windmill housings; video cards; video cassette recorders; video monitors; video recorders; virtual reality head-mounted video displays for use in playing video games; wearable video display monitors; wireless audio speakers; wireless headsets for smartphones; wireless routers

### **Class 11**

(2) air purifiers for household purposes; barbecue grills; barbecues; barbecues and grills; bathtubs; bicycle lamps; bicycle lights; book lights; bread baking machines; bread machines; candle lanterns; ceiling lights; charcoal roasters for household purposes; cooking grills; desk lamps; disinfectant dispensers for toilets; disinfectant distributors for toilets; dispensing units for room deodorant; electric grills; electric lamps; facial steamers; faucets; hair dryers; humidifiers; industrial air purifiers; irrigation sprinklers; lamp bulbs; lanterns; LED flashlights; led landscape lights; led light bulbs; light bulbs; lighting fixtures; lights for vehicles; mercury lamps; nail lamps; portable electric fans; portable electric heaters; portable evaporative air coolers; portable foot baths; portable headlamps; portable paper lanterns [chochin]; range hoods; reading lights; showerheads; solar powered lamps; sprinkler systems for lawn irrigation; steam accumulators; steam cookers; steam generating installations; steam generators; steam reformers for use in generating hydrogen gas; steam superheaters for industrial purposes; stoves; street lights; string lights for festive decoration; tail lights for vehicles; toilet bowls; toilet seats; ultraviolet (UV) lamps for use in disinfecting surfaces; ultraviolet light (UV) water purification device; ultraviolet sterilizers for water treatment; valves for lawn sprinkler systems; water fountains

**Application Number** 2,128,473  
**Language of Application** English

**Filing Date** 2021-08-20

## APPLICANT AND AGENT DETAILS

### Applicant

Haijun Luo  
No. 23, Zhoushang, Fishery Village, Quanjian  
Town, Suichuan County,  
Ji'an City, Jiangxi Province, 518000  
CHINA

### Agent

XIN XU  
(Fang An Law PC), Suite 300 & 306, 5500  
North Service Rd., Burlington, ONTARIO,  
L7L6W6

## TRADEMARK DETAILS

# HARUN

### Trademark Type

Standard Characters

### Goods

#### Class 09

(1) adapter plugs; anti-glare filters for computer monitors; anti-glare filters for televisions and computer monitors; arm rests for use with computers; augmented reality computer games for use on cellular phones; augmented reality computer games for use on mobile phones; augmented reality computer games for use on notebook computers; augmented reality computer games for use on personal computers; augmented reality computer games for use on smart phones; augmented reality computer games for use on tablet computers; augmented reality software for playing computer games; automatic altitude indicators; automatic answering machines; automatic cash dispensers; automatic cash registers; automatic cash sorting and counting machines; automatic chromatography apparatus for laboratory use; automatic controllers for revolving doors; automatic indicators of low pressure in tires; automatic indicators of low pressure in tyres; automatic indicators of low pressure in vehicle tires; automatic indicators of low pressure in vehicle tyres; automatic ion-exchange chromatography apparatus for laboratory use; automatic money counting and money changing machines; automatic solar tracking sensors; batteries and battery chargers for notebook computers; blank computer discs; blank discs for computers; blank floppy computer discs; blank hard disks for computers; blank USB flash drives; cameras; car antennas; car navigation computers; car videorecorders; carbon dioxide detectors; carbon monoxide detectors; card readers for magnetically encoded cards; carrying cases adapted for computers; carrying cases for notebook computers; carrying cases specially adapted for computer printers; cases adapted for computers; cases adapted for netbook computers; cases adapted for notebook computers; cases for smartphones; cases for tablet computers; CD cases; CD drives for computers; CD-ROMs containing computer games; cell phone antennas; cheque encoding machines; clock generators for computers; communications computers; compact disc drives for computers; compact discs containing computer games; computer accelerator boards; computer anti-virus software; computer application software for handheld computers that allows users to access and browse online profiles of pet care service providers; computer application software for mobile phones for use in database management; computer application software for mobile phones that allows users to access and browse online profiles of pet care service providers; computer application software for tablet devices that allows users to access and browse online profiles of pet

care service providers; computer application software in playing video and computer games; computer bags; computer buffers; computer cables; computer card adapters; computer carrying cases; computer cases; computer central processing units; computer chassis; computer chips; computer chipsets for use in transmitting data to and from a central processing unit; computer communications software to allow customers to access bank account information and transact bank business; computer daughterboards; computer disc drives; computer disk/disc drives; computer display monitors; computer display screens; computer e-commerce software to allow users to perform electronic business transactions via a global computer network; computer expansion boards; computer fax modem cards; computer fingerprint imaging software; computer fingerprint scanning software; computer game cartridges; computer game cartridges and discs; computer game cassettes; computer game programmes; computer game programs; computer game software; computer game software for game machines; computer game software for playing online betting games; computer game software for playing online casino games; computer game software for playing online gambling games; computer game software for playing online games of skill; computer game software for playing online prize games; computer game software for use on cellular phones; computer game software for use on mobile phones; computer game tapes; computer games; computer games downloadable from a global computer network; computer games for use on gaming machines; computer games for use on mobile and cellular phones; computer games for use on notebook computers; computer games for use on personal computers; computer games for use on slot machines; computer games for use on tablet computers; computer games for use on video lottery terminals; computer games in the field of basketball; computer graphics boards; computer graphics cards; computer hardware; computer hardware and computer software for database management; computer hardware and software for database management; computer hardware and software for setting up and configuring local area networks; computer hardware for data processing; computer hardware for network access servers; computer hardware for telecommunications; computer heat sinks; computer interface boards; computer interface cards; computer joysticks; computer keyboards; computer keypads; computer memory expansion modules; computer mice; computer monitor frames; computer monitors; computer motherboards; computer motherboards and daughterboards; computer mouse; computer mouse mats; computer mouse pads; computer network adapters; computer network adaptors; computer network bridges; computer network hubs; computer network hubs, switches and routers; computer network routers; computer network server; computer network switches; computer network-attached storage [NAS] hardware; computer networking hardware; computer operating programmes; computer operating programs; computer operating recorded programs; computer operating system software; computer operating systems; computer parallel ports; computer power supplies; computer printers; computer programmes for document management; computer programs (cad/cam) recorded on software designed for use in construction and automated manufacturing; computer programs and computer software for electronic trading of securities; computer programs and software for image processing; computer programs featuring badges for use in online virtual worlds; computer programs featuring characters for use in online virtual worlds; computer programs featuring clothes and accessories for use in online virtual worlds; computer programs featuring emojis for use in online virtual worlds; computer programs featuring stickers for use in online virtual worlds; computer programs for connecting to remote computers and computer networks; computer programs for editing images, sound and video; computer programs for language translations and training; computer programs for network management; computer programs for processing digital music files; computer programs for searching remotely for content on computers and computer networks; computer programs for searching the contents of computers and computer networks by remote control; computer programs for use in electronic commerce for processing electronic payments and authenticating the identity of payers; computer programs for using the Internet and

the World Wide Web; computer programs used for electronic cash register systems; computer scanners; computer screen filters; computer screen saver software; computer screen saver software, recorded or downloadable; computer screens; computer screensaver software; computer search engine software; computer serial ports; computer servers; computer skins, namely, fitted plastic film for covering and providing a scratch proof barrier for computers; computer software and databases for use in diagnosis, repair and configuration of computers; computer software and firmware for playing games of chance on dedicated gaming consoles; computer software and firmware for playing games of chance on reel based slot machines; computer software and firmware for playing games of chance on video based slot machines; computer software and firmware for playing games of chance on video lottery terminals; computer software featuring mathematical algorithms and indices for use in analyzing and evaluating dairy cow health and productivity; computer software for accessing, browsing and searching online databases; computer software for administering employee payroll; computer software for administration of computer local area networks; computer software for application and database integration; computer software for assisting developers in creating program code for use in mobile internet applications and client interfaces; computer software for assisting developers in creating program code for use in multiple application programs; computer software for authorising access to databases; computer software for computer-aided design/computer-aided manufacturing [CAD/CAM]; computer software for contact tracing and tracking of COVID-19 and other infectious diseases; computer software for controlling and managing access server applications; computer software for controlling and managing patient medical information; computer software for controlling and operating laser rangefinders; computer software for converting document images into electronic formats; computer software for creating and editing music; computer software for creating and editing music and sounds; computer software for creating and inserting metatags into documents and information; computer software for creating computer games; computer software for creating searchable databases; computer software for creating searchable databases of information and data; computer software for creating video games; computer software for creating, sending and receiving e-mail; computer software for data deduplication; computer software for data security; computer software for database management; computer software for digital animation and special effects of images; computer software for displaying orders and driver locations on maps; computer software for document management; computer software for editing images, sound, and video; computer software for editing music and for editing digital audio recordings; computer software for fingerprint imaging; computer software for fingerprint scanning; computer software for global positioning systems; computer software for graphic designing and editing; computer software for image processing; computer software for inventory management; computer software for language training; computer software for language translations; computer software for logistics, namely, software for tracking documents, packages and freight; computer software for managing retail store customer accounts; computer software for mathematical calculation; computer software for medical imaging; computer software for monitoring computer network access and activity; computer software for oil and gas reservoir analysis; computer software for operating computer games on the internet; computer software for operating system programs; computer software for optical character recognition; computer software for organising food recipes, monitoring calorie intake, and weigh control; computer software for organizing and viewing digital images and photographs; computer software for predictive and corrective text entry for use with smart phones, tablet computers and personal digital assistants; computer software for processing digital images; computer software for processing digital music files; computer software for project management; computer software for providing an on-line database in the field of transaction processing to upload transactional data, provide statistical analysis, and produce notifications and reports; computer software for running computer games on the internet; computer software for running development



programs and application programs in a common development environment; computer software for scanning, digitizing, altering and retouching of photographs; computer software for text editing; computer software for the collection of statistical production data for oil and gas field operations; computer software for the creation of firewalls; computer software for two or three-dimensional simulation for use in design and development of industrial products; computer software for use as a spreadsheet; computer software for use in cancer diagnosis; computer software for use in controlling and improving computer processing speed; computer software for use in creating and designing web sites; computer software for use in database management; computer software for use in generating streaming advertisements on the web sites of others; computer software for use in managing and controlling production schedules, shipping schedules, purchase of materials, inventories and accounts; computer software for use in processing semiconductor wafers; computer software for use in programming facsimile machines; computer software for use in providing multiple user access to a global computer information network; computer software for use in the encryption and decryption of digital files; computer software for use in the management of payroll; computer software for validating address and zone information; computer software for video editing; computer software for visual art designing and editing; computer software for word processing; computer software that allows transmission of graphics to mobile telephones; computer software that provides real-time, integrated business management intelligence by combining information from various databases; computer software to allow users to perform electronic payment transactions; computer software to automate data warehousing; computer software to calculate and charge sales tax and to create reports to pay sales tax to appropriate tax agencies; computer software to create and manage budgets; computer software to create price quote estimates and transfer price quote estimates to invoices; contact lenses; covers for tablet computers; credit card encoding machines; desktop computers; dish aerials; door chimes; DVD burners; DVD cases; DVD drives; DVD players; DVD recorders; DVD sleeves; DVDs containing instruction manuals in welding; DVDs containing movie recordings; DVDs containing recordings of television shows and movies; electric batteries for cameras; electric batteries for portable computers; electric batteries for powering electric vehicles; electric batteries for smartphones; electric batteries for tablet computers; electric batteries for vehicles; electric batteries for watches; electric buzzers; electric cable connectors; electric cables; electric door chimes; electronic ballasts for lamps; electronic door locks; electronic lock assemblies; electronic sensors for measuring solar radiation; encoded bank cards; encoded bar code labels; encoded credit cards; encoded debit cards; encoded electronic chip cards for identifying particular users of computers and cell phones; encoded electronic chip cards for identifying particular users of computers and mobile phones; encoded gift cards; encoded identity cards; encoded key cards; encoded key cards, namely, encoded identity cards, identification cards with embedded chips, identification smart cards; encoded magnetic identification bracelets; encoded prepaid credit cards; eyeglass mountings; flash lamps for cameras; flash lamps for photography; fuel level indicators for vehicles; head mounted audio-visual display units containing integrated cameras and sensors; head mounted displays; headsets; helmet camera mounts; infrared sensors; integrated circuit modules; keyboards for cellular telephones; keyboards for computers; lanyards for holding encoded identity cards; laser diode modules; lcd monitors; LED displays; led monitors; LED position sensors; lens filters for cameras; light-emitting diode [LED] microscopes; light-emitting diode [LED] monitors; light-emitting diode [LED] televisions; light-emitting diodes [LED]; liquid crystal display (LCD) televisions; liquid crystal display monitors; liquid level sensors; long distance telephone calling cards, magnetically encoded; loud speakers; magnetic encoded card readers; magnetic encoded identification bracelets; magnetic mount flashing safety lights for vehicles; magnetically encoded bank cards; magnetically encoded card readers; magnetically encoded credit cards; magnetically encoded debit cards; magnetically encoded gift cards; magnetically encoded hotel room key cards;

magnetically encoded identification bracelets; magnetically encoded identification cards; magnetically encoded phone cards; metal detectors; mobile phone chargers; motion detectors; motion sensors; motion sensors for security lights; mounting racks adapted for computer hardware; mounting racks for computer hardware; mounts for helmet cameras; mounts for smartphones; oil level indicators for vehicles; oil level sensors; optical sensors; phase indicators; photovoltaic cells and modules; photovoltaic modules; pince-nez mountings; pollutant sensors; pre-paid telephone calling cards, magnetically encoded; pressure sensors; protective cases for smartphones; protective face-shields for protective helmets; proximity sensors; radio aerials; radio antennas; radio signal antennas; rectifier modules; satellite aerials; sensors for determining acceleration; sensors for determining temperature; sensors for determining velocity; slide film mounts; smartphone mounts; speaker mounting brackets; subscriber identification module (SIM) card; tablet computers; television aerials; temperature sensors; thermal sensors; timing sensors; USB cables; USB chargers; USB flash drives; velocity sensors; vibration sensors for installation in wind mill housings; vibration sensors for installation in windmill housings; video cards; video cassette recorders; video monitors; video recorders; virtual reality head-mounted video displays for use in playing video games; wearable video display monitors; wireless audio speakers; wireless headsets for smartphones; wireless routers

### **Class 11**

(2) air purifiers for household purposes; barbecue grills; barbecues; barbecues and grills; bathtubs; bicycle lamps; bicycle lights; book lights; bread baking machines; bread machines; candle lanterns; ceiling lights; charcoal roasters for household purposes; cooking grills; desk lamps; disinfectant dispensers for toilets; disinfectant distributors for toilets; dispensing units for room deodorant; electric grills; electric lamps; facial steamers; faucets; hair dryers; humidifiers; industrial air purifiers; irrigation sprinklers; lamp bulbs; lanterns; LED flashlights; led landscape lights; led light bulbs; light bulbs; lighting fixtures; lights for vehicles; mercury lamps; nail lamps; portable electric fans; portable electric heaters; portable evaporative air coolers; portable foot baths; portable headlamps; portable paper lanterns [chochin]; range hoods; reading lights; showerheads; solar powered lamps; sprinkler systems for lawn irrigation; steam accumulators; steam cookers; steam generating installations; steam generators; steam reformers for use in generating hydrogen gas; steam superheaters for industrial purposes; stoves; street lights; string lights for festive decoration; tail lights for vehicles; toilet bowls; toilet seats; ultraviolet (UV) lamps for use in disinfecting surfaces; ultraviolet light (UV) water purification device; ultraviolet sterilizers for water treatment; valves for lawn sprinkler systems; water fountains

**Application Number** 2,128,637  
**Language of Application** English

**Filing Date** 2021-08-21

## APPLICANT DETAILS

### Applicant

SHENZHEN P&S BUSINESS CO., LTD.  
308, 1970 TECH PARK  
MINZHI COMMUNITY, MINZHI ST.,  
LONGHUA DIST.  
SHENZHEN, 518000  
CHINA

## TRADEMARK DETAILS

# Apebr

### Trademark Type

Standard Characters

### Goods

#### Class 09

(1) 3D spectacles; adapter plugs; bags adapted for laptops; battery chargers for mobile phones; burglar alarms; cabinets for loudspeakers; camcorders; car video recorders; cases for smartphones; cell phone straps; computer hardware for data processing; computer keyboards; computer monitors; computer mouse; computer printers; computer scanners; computer utility programs for providing diagnostic details on devices installed in a computer system; covers for smartphones; covers for tablet computers; data cables; electric batteries for cameras; electric batteries for portable computers; electric batteries for smartphones; electric batteries for tablet computers; electric batteries for watches; electric door bells; electric light switches; electric sockets; electric wires; electronic book readers; electronic calculators; electronic collars to train animals; electronic digital signboards, namely, luminous signs and neon signs; electronic pocket translators; eyeglasses; global positioning system (GPS) consisting of computers, computer software, transmitters, receivers, and network interface devices; hand-held monopod; loudspeakers; mouse pads; portable DVD players; portable MP3 players; protective films adapted for computer screens; protective films adapted for screens for mobile phones; protective films adapted for smart phones; protective helmets for sports; radar; sleeves for laptops; smartwatches; solar batteries; sunglasses; tripods for cameras; video baby monitors; video monitors; video screens; wireless computer mice

#### Class 12

(2) air bags for automobiles; anti-skid chains for vehicle tires; anti-skid textile covers for tires; anti-theft alarms for vehicles; anti-theft devices for motor cars; anti-theft warning apparatus for motor cars; ashtrays for automobiles; automobile bodies; bags adapted for strollers; bicycle bells; bicycle chains; bicycle handlebars; bicycle kickstands; bicycle mudguards; bicycle stands; bicycles; brake pads for automobiles; bumpers for automobiles; chain guards for bicycles; covers for vehicle steering wheels; electrical anti-theft installations for vehicles; electrically powered motor vehicles; gears for bicycles; head-rests for vehicle seats; hoods for vehicle engines; hoods for vehicles; luggage carriers for vehicles; motorcycle chains; motorcycle frames; motorcycle saddles; panniers

adapted for motorcycles; pet strollers; push scooters; rearview mirrors; reversing alarms for vehicles; saddlebags adapted for bicycles; safety seats for children for motor cars; safety seats for infants and children for vehicles; self-balancing boards; self-balancing scooters; shock absorbers for automobiles; shock absorbers for bicycles; shock absorbing springs for vehicles; spare tire covers; stroller covers; strollers; sun blinds for automobiles; suspension shock absorbers for vehicles; upholstery for vehicles; vehicle bumpers; vehicle running boards; windshield wipers

**Class 27**

(3) anti-slip floor coverings for use on staircases; anti-slip floor mats; artificial turf; artificial turf for laying on the surfaces of recreational areas; automobile carpets; bath mats; beach mats; carpet underlay; carpets; carpets and rugs; carpets for automobiles; cloth wall coverings; decorative slip-resistant floor coverings in sheet form; decorative wall hangings, not of textile; disposable absorbent floor pads; door mats; fabric wall coverings; fire resistant floor mats for fireplaces and barbecues; floor mats; floor mats for motor vehicles; floor mats for vehicles; floor mats made of plastic; floor mats made of textiles; floor mats of rubber; foam mats for use on play area surfaces; gymnasium exercise mats; gymnasium mats; gymnastic mats; linoleum; linoleum for covering existing floors; linoleum for use on floors; mats of woven rope for creating ski slope surfaces; mats of woven rope for ski slopes; non-slip mats for baths; non-textile wall hangings; paper floor mats; personal exercise mats; personal sitting mats; pet feeding mats; rubber floor mats; rubber mats; rugs; rush mats; synthetic fur rugs; tatami mats; textile bath mats; textile lined wallpaper; textile wallpaper; vinyl floor coverings; wallpaper; wallpaper with a textile covering; yoga mats

**Application Number** 2,128,651  
**Language of Application** English

**Filing Date** 2021-08-21

## APPLICANT DETAILS

### Applicant

Progoalie Inc.  
254 Clinton St  
Toronto  
ONTARIO  
M6G2Y6

## TRADEMARK DETAILS

# PROGOALIE

### Trademark Type

Standard Characters

### Goods

#### Class 25

(1) adult sweatpants; ankle socks; athletic apparel; athletic clothing; athletic footwear; athletic pants; athletic shirts; athletic shoes; athletic shorts; athletic tights; athletic uniforms; athletic wear; baseball caps; baseball caps and hats; baseball hats; baseball jerseys; baseball shirts; bath sandals; bath shoes; bath slippers; bathing costumes; bathing costumes for women; bathing drawers; bathing suits; bathing suits for men; bathing trunks; bathrobes; beach clothes; beach footwear; beach jackets; beach shoes; beanies; belts; belts made from imitation leather; belts made of leather; blanket sleepers; blazers; blouses; blue jeans; boardshorts; bomber jackets; bomber vests; boots; boxer briefs; boxer shorts; bralettes; bras; briefs; button down shirts; caps; casual and athletic clothing; casual clothing featuring pants, dresses and shorts; casual footwear; casual pants; casual shirts; casual shoes; casual trousers; casual wear; children's clothing; children's footwear; children's shirts; clothing for sports; coats; denim coats; denim jackets; denim jeans; down jackets; dress clothing; earmuffs; exercise wear; field hockey shoes; fleece pullovers; fleece tops; golf footwear; golf hats; golf pants; golf shirts; golf shoes; golf shorts; golf skirts; golf trousers; golf wear; gym shorts; gym wear; hats and caps; headbands; hockey jerseys; hockey shoes; hockey sweaters; hockey uniforms; hooded jackets; hooded pullovers; hooded sweatshirts; hoodies; housecoats; jackets; jean jackets; jeans; jerseys; jikatabi [Japanese split-toed work footwear]; leather coats; leather jackets; leg warmers; leisure shoes; leisurewear; long sleeve pullovers; long sleeve shirts; long underwear; loungewear; lounging pyjamas; men's sandals; men's shirts; men's socks; men's underwear; moccasins; moisture-wicking sports bras; moisture-wicking sports pants; muscle shirts; night dresses; night shirts; outdoor winter clothing; outdoor winter footwear; outerwear jackets; padded jackets; pajamas; panties; pants; parkas; pea coats; perspiration absorbent underwear; perspiration absorbent underwear clothing; pockets for clothing; polo knit tops; polo shirts; ponchos; printed t-shirts; promotional caps; promotional t-shirts; pullovers; pyjamas; rompers; rugby shirts; running shoes; running shorts; sandals and beach shoes; scarves; school uniforms; shell jackets; shirt fronts; shirts; short-sleeve shirts; ski and snowboard shoes and parts thereof; slippers; sneakers; snow boots; snow pants; snow suits; soccer boots; soccer shoes; soccer uniforms; socks; soles for footwear; sport bibs; sport coats; sport jackets; sport shirts; sport stockings; sports bras; sports caps; sports caps and hats; sports

clothing; sports coats; sports footwear; sports jackets; sports jerseys; sports jerseys and breeches for sports; sports overuniforms; sports pants; sports shirts; sports shirts with short sleeves; sports shoes; sports singlets; sports socks; sports uniforms; sports vests; sportswear; stockings; stretch pants; suits; sun hats; sun protective clothing; suspenders; sweat bands; sweat jackets; sweat pants; sweat shirts; sweat shorts; sweat socks; sweat suits; sweat tops; sweat-absorbent socks; sweat-absorbent underclothing; sweat-absorbent underwear; sweatbands; sweaters; sweatpants; sweatshirts; t-shirts; tank-tops; team jerseys; team shirts; tee shirts; thermal socks; thermal underwear; thong sandals; thong underwear; ties; tights; tongue for shoes and boots; toques; track and field shoes; track jackets; track pants; track shoes; track suits; tracksuit bottoms; tracksuit tops; tracksuits; training shoes; training suits; trench coats; trousers; trousers for sweating; tube tops; tuques; turbans; turtleneck sweaters; turtlenecks; underclothing; undergarments; undershirts; underwear; vests; walking shoes; warm-up pants; warm-up suits; warm-up tops; winter boots; winter coats; winter gloves; winter jackets; women's lingerie; women's shirts; women's shoes; women's socks; women's sportswear; woven shirts; woven tops; wrist bands; wrist warmers; yoga pants; yoga tops

### **Class 28**

(2) abdomen protectors for karate; abdomen protectors for martial arts; action figure play sets; action figure toys; action figures; action skill games; action target games; arcade games; arcade games and apparatus for use with an external display screen or monitor namely video game consoles; arcade-type electronic video games; arm bands featuring motion sensors and gesture control software for use with interactive video games; athletic sporting goods, namely, athletic wrist, ankle and joint supports; automatic gaming machines; baby toys; bags adapted for ice hockey sticks; bags adapted for lacrosse sticks; bags adapted for use with sporting equipment; bags specially adapted for sports equipment; balls for games; balls for playing field hockey; balls for sports; battery operated action toys; battery-powered computer game with LCD screen; bindings for snowboards; blade guards for ice skates; blades for ice hockey sticks; blocking dummies; board games; body protectors for athletic use; body protectors for sports use; card games; cases for action figures; cases specially adapted for sports equipment; chest guards for athletic use; chest protectors for athletic use; chest protectors for hockey; chest protectors for ice hockey; chest protectors for sports use; children's multiple activity toys; Christmas decorations; Christmas ornaments; Christmas tree ornaments; Christmas tree skirts; clockwork toys of metal; collectible toy figures; corner flags for playing fields; corner flags for sports fields; covers for golf clubs; dart boards; decorations and ornaments for Christmas trees; educational toys; elbow guards for athletic use; elbow guards for sports use; elbow pads; elbow pads for athletic use; elbow pads for sports use; electric action toys; electronic action toys; electronic games consoles adapted for use with an external display screen or monitor; electronic targets for games and sports; exercise balls; exercise benches; exercise platforms; exercise trampolines; exercise treadmills; exercise weights; face guards for athletic use; face guards for sports use; face masks for sports; field hockey balls; field hockey gloves; field hockey goal nets; field hockey goalkeeper pads; field hockey goals; field hockey sticks; fitted head covers for golf clubs; fitted protective covers specially adapted for golf clubs; gloves for soccer goalkeepers; goalkeeper's gloves; goals for field hockey; goals for ice hockey; golf bag covers; golf clubs; grips for golf clubs; Halloween masks; Halloween play sets; hand wraps for sports use; hand-held, non-electronic skill games; head covers for golf clubs; hockey bags; hockey bags adapted to equipment; hockey balls; hockey gloves; hockey goals; hockey nets; hockey pads; hockey pants; hockey pucks; hockey skates; hockey sticks; hockey tape; ice hockey gloves; ice hockey goal nets; ice hockey goalkeeper pads; ice hockey goals; ice hockey pucks; ice hockey skates; ice hockey stick blades; ice hockey stick shafts; ice hockey sticks; ice skate blade guards; ice skate blades; ice skate guards; ice skates; inflatable bop

bags; inflatable games for swimming pools; inflatable pool toys; inflatable thin rubber toys; inflatable toys; interactive board games; interactive control floor pads for video games; jockstraps; jogging machines; kettlebells; knee guards for sports use; knee pads for sports use; laces for athletic equipment; lacrosse balls; lacrosse gloves; lacrosse stick strings; lacrosse sticks; lever action toys; lottery cards; lottery tickets; mechanical toys; medicine balls; memory games; men's athletic supporters; metal clockwork toys; model toys; molded toy figures; moulded toy figures; multi-sport uprights; nets for ball games; nets for ice hockey goals; nets for soccer goals; nets for sports; novelty face masks; novelty masks; ordinary playing cards; outdoor activity play sets; pads for field hockey goalkeepers; pads for ice hockey goalkeepers; plastic character toys; plastic clockwork toys; plastic toy figurines; plastic toys; plastic toys for use in the bath; playing balls; playing cards and card games; positionable toy figures; protective padding for playing sports; protective supports for shoulders and elbows; puck rebounders for hockey training; pucks for playing ice hockey; radio-controlled miniature aerial targets for sports; radio-controlled toys; roller and ice skates; rubber action balls; rubber balls; rubber character toys; rubber toys; scale model figures; shafts for ice hockey sticks; shaped covers for golf bags; shaped covers for golf club heads; shaped covers for golf clubs; shaped covers for golf putters; shin guards for sports use; shin pads for athletic use; shoulder pads for sports use; skate blade guards; skating boots with skates attached; small toys; snow boards; snow sledges for recreational use; snowboard bindings; snowboards; snowshoes; soccer balls; soccer goal nets; soccer goalkeepers' gloves; soccer goals; soccer knee pads; sport balls; sport gloves; sports balls; sports gloves; sports goal posts; stationary bicycles; stationary exercise bicycles; striking shields for athletic use; striking shields for sports use; stuffed toys; table top games; talking toys; throat protectors for sports use; toy action figures; toy and novelty face masks; umpire protection equipment; video game consoles; video game consoles for use with an external display screen or monitor; video game interactive control floor pads or mats

## **Services**

### **Class 35**

(1) catalogue shopping services in the field of sporting goods; consignment sale of sporting goods; discount sporting goods stores; online retail services for downloadable and pre-recorded music and movies; online sales of clothing; online sales of footwear; online sales of headwear; online sales of sporting goods; online sales of toys; production of advertising films for others; production of infomercials; production of television commercials; promoting the sale of goods and services through promotional contests and the distribution of related printed material; promotional management for sports personalities; providing home shopping services of sporting goods via the Internet; providing market intelligence services; provision of information relating to market studies; provision of space on websites for advertising goods and services; publicity agencies; publicity agency services; retail clothing store services; retail sale of clothing; retail sale of footwear; retail sale of sporting goods; retail sale of toys; retail services for apparel, boots, shoes, and bags; retail services for clothing, footwear, and bags; retail services for computer software; retail services for shoes, boots, handbags; retail store services featuring clothing; sale of clothing; sale of computer software; social media strategy consulting; sports recruiting services for high school athletes; statistical analysis and reporting services for business purposes; statistical evaluation of data from market studies; statistical evaluation of market research data; statistical evaluations of marketing data; strategic business analysis; subscription to a television channel; subscriptions to electronic journals; telemarketing services; wholesale sales of clothing; wholesale sales of home entertainment electronics; wholesale sales of sporting goods; wholesale store services featuring clothing

**Class 41**

(2) arranging and conducting hockey competitions; booking of seats for shows and sports events; coaching in the field of sports; conducting fitness classes; developing educational manuals; developing fitness programs; development of television programs; development, creation, production, distribution, and post-production of motion pictures; development, creation, production, distribution, and post-production of multimedia entertainment content, namely television series and documentaries; digital photography; entertainment in the form of live performances by a musical band; entertainment in the form of personal appearances by a sports celebrity or movie star; entertainment in the form of television shows; entertainment in the nature of hockey games; entertainment in the nature of ice-skating competitions; entertainment in the nature of lacrosse games; entertainment services in the nature of non-downloadable television shows and movies transmitted via the internet; entertainment services in the nature of non-downloadable videos and images featuring television shows and movies transmitted via wireless computer networks; entertainment services in the nature of reality television series; entertainment services such as hockey games; entertainment services, namely, providing online electronic games; entertainment services, namely, providing temporary use of non-downloadable computer games; entertainment ticket agency services; fan club services; film and video production; fitness training; gambling services; golf clinics; golf instruction; ice skating instruction; mascot services; officiating at sports competition; on-line publication of electronic books and journals; online casino gaming services; online computer games; online gambling services; online non-downloadable computer games; online publication of electronic books and magazines; online publication of electronic books and periodicals; online publication of electronic periodicals; online video gaming services; operation and coordination of electronic game tournaments; operation and coordination of electronic sports competitions; operation and coordination of team sports competitions; operation of an educational institution at the college level; operation of an educational institution at the university level; operation of sports camps; organisation of golf tournaments; organization of e-sports; organization of hockey tournaments; organization of soccer competitions; organization of soccer games; organization of video gaming leagues; pay television programming; performance measurement evaluations in the field of education; personal fitness training services; photographic computer imaging; physical education; physical education services; physical fitness consulting services; physical fitness instruction; planning of professional golf tournaments; production and distribution of movies; production and distribution of radio programmes; production and distribution of television shows; production of documentary programmes for broadcasting on the internet; production of films; production of live comedy shows; production of motion picture films; production of news programmes for broadcasting on the internet; production of news webcasts; production of radio and television programmes; production of video games; providing entertainment and educational day camp services; providing entertainment information in the field of television programming; providing entertainment services at holiday camps; providing facilities for hockey tournaments; providing films, not downloadable, via video-on-demand services; providing fitness and exercise facilities; providing gymnasiums; providing information in the field of exercise via an interactive website; providing information in the field of television shows and movies via a website; providing information in the field of university courses; providing information in the field of virtual reality games via an online blog; providing information on entertainment in the field of computer games, video games, card games, animated cartoons, comics, novels and magazines; providing news and information in the field of sports; providing non-downloadable casino games and video games via the Internet; providing non-downloadable casino games and video games via wireless computer networks; providing on-line computer games; providing online augmented reality computer games for use on mobile phones, smart phones, cellular phones, personal computers,



tablet computers, notebook computers; providing online electronic games for use on mobile phones; providing online non-downloadable audio and visual recordings in the field of computer games and video games; providing online virtual reality computer games for use on mobile phones, smart phones, cellular phones, personal computers, tablet computers, notebook computers; providing recreational areas in the nature of play areas for children; providing skating rink facilities; providing skating rinks; providing sports arena facilities; providing television programmes, not downloadable, via video-on-demand services; providing television programmes, not downloadable, via video-on-demand transmission services; providing television programs, not downloadable, via video-on-demand services; providing temporary use of online on-downloadable electronic games; providing tracking of users of virtual sports services and matching online game players with other players of all skill levels; providing tracking of users of electronic sports and matching online game players with other players of all skill levels; providing tracking of users of online interactive electronic gaming and matching online game players with other players of all skill levels; publication of brochures; publication of catalogs; publication of diagrams, namely, charts and graphs, and photographs; publication of electronic books and magazines on-line; publishing of computer game software; publishing of electronic games; publishing of magazines in electronic form; publishing of video game software; rental of sports equipment; Rental of stadium facilities; rental of video games; sale of concert tickets; sale of lottery tickets; sport camp services; sports camps; sports instruction in the field of hockey; sports officiating; sports refereeing; teaching physical fitness; television program syndication; television programming; television show production; ticket reservation and booking of seats for entertainment, sporting and cultural events; timing of sporting events; tutoring; video production; wagering services; yoga instruction

**Application Number** 2,128,735  
**Language of Application** English

**Filing Date** 2021-08-23

## APPLICANT AND AGENT DETAILS

### Applicant

Sailun Group Co., Ltd.  
No. 588, Maoshan Road  
Huangdao District, Qingdao  
Shandong  
CHINA

### Agent

CATHERINE M. DENNIS BROOKS  
(MILLER THOMSON LLP), SCOTIA PLAZA,  
40 KING STREET WEST, TORONTO,  
ONTARIO, M5H3S1

## TRADEMARK DETAILS

# ERANGE

**Trademark Type**  
Standard Characters

### Goods

**Class 12**

tires

**Application Number** 2,128,742  
**Language of Application** English

**Filing Date** 2021-08-23

## APPLICANT AND AGENT DETAILS

### Applicant

Sailun Group Co., Ltd.  
No. 588, Maoshan Road  
Huangdao District, Qingdao  
Shandong  
CHINA

### Agent

CATHERINE M. DENNIS BROOKS  
(MILLER THOMSON LLP), SCOTIA PLAZA,  
40 KING STREET WEST, TORONTO,  
ONTARIO, M5H3S1

## TRADEMARK DETAILS

### Trademark Type

Design

### Visual Representation

**ERANGE** | **EV**

### Goods

Class 12

tires

**Application Number** 2,128,784  
**Language of Application** English

**Filing Date** 2021-08-23

## APPLICANT AND AGENT DETAILS

### Applicant

Walmart Apollo, LLC  
702 S.W. 8th Street  
MS 0215  
Bentonville, AR 72716  
UNITED STATES OF AMERICA

### Agent

CPST INTELLECTUAL PROPERTY INC.  
130 Queens Quay East, East Tower, Suite  
809, Toronto, ONTARIO, M5A0P6

## TRADEMARK DETAILS

# SPARK A MIRACLE

### Trademark Type

Standard Characters

### Services

#### Class 36

charitable fundraising services

**Application Number** 2,128,798  
**Language of Application** English

**Filing Date** 2021-08-23

## APPLICANT AND AGENT DETAILS

### Applicant

Red Iron Group Management, LLC  
c/o Cooley LLP  
1299 Pennsylvania Avenue NW, Suite 700  
Washington, DC 20004  
UNITED STATES OF AMERICA

### Agent

GOWLING WLG (CANADA) LLP  
SUITE 1600, 1 FIRST CANADIAN PLACE, 100  
KING STREET WEST, TORONTO, ONTARIO,  
M5X1G5

## TRADEMARK DETAILS

# RED IRON GROUP

### Trademark Type

Standard Characters

### Services

#### Class 35

(1) providing advisory and consultation services to companies in the field of corporate governance oversight;

#### Class 36

(2) equity investment in companies; investment services for acquiring majority equity interests from shareholders in private companies for the purpose of obtaining a majority control ownership position; majority shareholder equity investment services; providing controlling interest investment services; providing investment for the purpose of obtaining a majority control ownership position in private companies;

**Application Number** 2,128,848  
**Language of Application** English

**Filing Date** 2021-08-24

## APPLICANT AND AGENT DETAILS

### Applicant

Jonathan Dresner  
5732 Rue Sherbrooke O  
Montréal  
QUEBEC  
H4A1W8

### Agent

PINTO LÉGAL  
345 Victoria Avenue, Suite 401, Westmount,  
QUEBEC, H3Z2N2

## TRADEMARK DETAILS

# HANG TIME PIZZA

### Trademark Type

Standard Characters

### Goods

#### Class 30

pizzas

### Services

#### Class 43

bar and restaurant services; restaurant services; restaurant services featuring take-out services; restaurants

**Application Number** 2,128,850  
**Language of Application** English

**Filing Date** 2021-08-24

## APPLICANT AND AGENT DETAILS

### Applicant

Meiqin Ning  
No.59, YouMaChang Group, Ningchang Village  
Shouan Town, Fuliang County  
Jingdezhen, Jiangxi, 333401  
CHINA

### Agent

PAUL B. BÉLANGER  
4360 av de Hampton, MONTRÉAL, QUEBEC,  
H4A2L2

## TRADEMARK DETAILS

# PTHAHNIL

### Trademark Type

Standard Characters

### Goods

#### Class 24

banners of textile or plastic; bath linen; bed linen; blankets for household pets; coasters of textile; cotton fabrics; fabrics made of synthetic materials; flags of textile or plastic; furniture coverings of textile; linen for household purposes; pillow shams; pillowcases; place mats of textile; printed calico cloth; sleeping bags; table linen; table napkins of textile; table runners of textile; tablecloths; upholstery fabrics

**Application Number** 2,128,855  
**Language of Application** English

**Filing Date** 2021-08-24

## APPLICANT AND AGENT DETAILS

### Applicant

Haijun Luo  
No. 23, Zhoushang, Fishery Village, Quanjian  
Town, Suichuan County,  
Ji'an City, Jiangxi Province, 518000  
CHINA

### Agent

XIN XU  
(Fang An Law PC), Suite 300 & 306, 5500  
North Service Rd., Burlington, ONTARIO,  
L7L6W6

## TRADEMARK DETAILS

# HKOMA

### Trademark Type

Standard Characters

### Goods

#### Class 09

(1) adapter plugs; anti-glare filters for computer monitors; anti-glare filters for televisions and computer monitors; arm rests for use with computers; augmented reality computer games for use on cellular phones; augmented reality computer games for use on mobile phones; augmented reality computer games for use on notebook computers; augmented reality computer games for use on personal computers; augmented reality computer games for use on smart phones; augmented reality computer games for use on tablet computers; augmented reality software for playing computer games; automatic altitude indicators; automatic answering machines; automatic cash dispensers; automatic cash registers; automatic cash sorting and counting machines; automatic chromatography apparatus for laboratory use; automatic controllers for revolving doors; automatic indicators of low pressure in tires; automatic indicators of low pressure in tyres; automatic indicators of low pressure in vehicle tires; automatic indicators of low pressure in vehicle tyres; automatic ion-exchange chromatography apparatus for laboratory use; automatic money counting and money changing machines; automatic solar tracking sensors; batteries and battery chargers for notebook computers; blank computer discs; blank discs for computers; blank floppy computer discs; blank hard disks for computers; blank USB flash drives; cameras; car antennas; car navigation computers; car videorecorders; carbon dioxide detectors; carbon monoxide detectors; card readers for magnetically encoded cards; carrying cases adapted for computers; carrying cases for notebook computers; carrying cases specially adapted for computer printers; cases adapted for computers; cases adapted for netbook computers; cases adapted for notebook computers; cases for smartphones; cases for tablet computers; CD cases; CD drives for computers; CD-ROMs containing computer games; cell phone antennas; cheque encoding machines; clock generators for computers; communications computers; compact disc drives for computers; compact discs containing computer games; computer accelerator boards; computer anti-virus software; computer application software for handheld computers that allows users to access and browse online profiles of pet care service providers; computer application software for mobile phones for use in database management; computer application software for mobile phones that allows users to access and browse online profiles of pet care service providers; computer application software for tablet devices that allows users to access and browse online profiles of pet



care service providers; computer application software in playing video and computer games; computer bags; computer buffers; computer cables; computer card adapters; computer carrying cases; computer cases; computer central processing units; computer chassis; computer chips; computer chipsets for use in transmitting data to and from a central processing unit; computer communications software to allow customers to access bank account information and transact bank business; computer daughterboards; computer disc drives; computer disk/disc drives; computer display monitors; computer display screens; computer e-commerce software to allow users to perform electronic business transactions via a global computer network; computer expansion boards; computer fax modem cards; computer fingerprint imaging software; computer fingerprint scanning software; computer game cartridges; computer game cartridges and discs; computer game cassettes; computer game programmes; computer game programs; computer game software; computer game software for game machines; computer game software for playing online betting games; computer game software for playing online casino games; computer game software for playing online gambling games; computer game software for playing online games of skill; computer game software for playing online prize games; computer game software for use on cellular phones; computer game software for use on mobile phones; computer game tapes; computer games; computer games downloadable from a global computer network; computer games for use on gaming machines; computer games for use on mobile and cellular phones; computer games for use on notebook computers; computer games for use on personal computers; computer games for use on slot machines; computer games for use on tablet computers; computer games for use on video lottery terminals; computer games in the field of basketball; computer graphics boards; computer graphics cards; computer hardware; computer hardware and computer software for database management; computer hardware and software for database management; computer hardware and software for setting up and configuring local area networks; computer hardware for data processing; computer hardware for network access servers; computer hardware for telecommunications; computer heat sinks; computer interface boards; computer interface cards; computer joysticks; computer keyboards; computer keypads; computer memory expansion modules; computer mice; computer monitor frames; computer monitors; computer motherboards; computer motherboards and daughterboards; computer mouse; computer mouse mats; computer mouse pads; computer network adapters; computer network adaptors; computer network bridges; computer network hubs; computer network hubs, switches and routers; computer network routers; computer network server; computer network switches; computer network-attached storage [NAS] hardware; computer networking hardware; computer operating programmes; computer operating programs; computer operating recorded programs; computer operating system software; computer operating systems; computer parallel ports; computer power supplies; computer printers; computer programmes for document management; computer programs (cad/cam) recorded on software designed for use in construction and automated manufacturing; computer programs and computer software for electronic trading of securities; computer programs and software for image processing; computer programs featuring badges for use in online virtual worlds; computer programs featuring characters for use in online virtual worlds; computer programs featuring clothes and accessories for use in online virtual worlds; computer programs featuring emojis for use in online virtual worlds; computer programs featuring stickers for use in online virtual worlds; computer programs for connecting to remote computers and computer networks; computer programs for editing images, sound and video; computer programs for language translations and training; computer programs for network management; computer programs for processing digital music files; computer programs for searching remotely for content on computers and computer networks; computer programs for searching the contents of computers and computer networks by remote control; computer programs for use in electronic commerce for processing electronic payments and authenticating the identity of payers; computer programs for using the Internet and

the World Wide Web; computer programs used for electronic cash register systems; computer scanners; computer screen filters; computer screen saver software; computer screen saver software, recorded or downloadable; computer screens; computer screensaver software; computer search engine software; computer serial ports; computer servers; computer skins, namely, fitted plastic film for covering and providing a scratch proof barrier for computers; computer software and databases for use in diagnosis, repair and configuration of computers; computer software and firmware for playing games of chance on dedicated gaming consoles; computer software and firmware for playing games of chance on reel based slot machines; computer software and firmware for playing games of chance on video based slot machines; computer software and firmware for playing games of chance on video lottery terminals; computer software featuring mathematical algorithms and indices for use in analyzing and evaluating dairy cow health and productivity; computer software for accessing, browsing and searching online databases; computer software for administering employee payroll; computer software for administration of computer local area networks; computer software for application and database integration; computer software for assisting developers in creating program code for use in mobile internet applications and client interfaces; computer software for assisting developers in creating program code for use in multiple application programs; computer software for authorising access to databases; computer software for computer-aided design/computer-aided manufacturing [CAD/CAM]; computer software for contact tracing and tracking of COVID-19 and other infectious diseases; computer software for controlling and managing access server applications; computer software for controlling and managing patient medical information; computer software for controlling and operating laser rangefinders; computer software for converting document images into electronic formats; computer software for creating and editing music; computer software for creating and editing music and sounds; computer software for creating and inserting metatags into documents and information; computer software for creating computer games; computer software for creating searchable databases; computer software for creating searchable databases of information and data; computer software for creating video games; computer software for creating, sending and receiving e-mail; computer software for data deduplication; computer software for data security; computer software for database management; computer software for digital animation and special effects of images; computer software for displaying orders and driver locations on maps; computer software for document management; computer software for editing images, sound, and video; computer software for editing music and for editing digital audio recordings; computer software for fingerprint imaging; computer software for fingerprint scanning; computer software for global positioning systems; computer software for graphic designing and editing; computer software for image processing; computer software for inventory management; computer software for language training; computer software for language translations; computer software for logistics, namely, software for tracking documents, packages and freight; computer software for managing retail store customer accounts; computer software for mathematical calculation; computer software for medical imaging; computer software for monitoring computer network access and activity; computer software for oil and gas reservoir analysis; computer software for operating computer games on the internet; computer software for operating system programs; computer software for optical character recognition; computer software for organising food recipes, monitoring calorie intake, and weigh control; computer software for organizing and viewing digital images and photographs; computer software for predictive and corrective text entry for use with smart phones, tablet computers and personal digital assistants; computer software for processing digital images; computer software for processing digital music files; computer software for project management; computer software for providing an on-line database in the field of transaction processing to upload transactional data, provide statistical analysis, and produce notifications and reports; computer software for running computer games on the internet; computer software for running development

programs and application programs in a common development environment; computer software for scanning, digitizing, altering and retouching of photographs; computer software for text editing; computer software for the collection of statistical production data for oil and gas field operations; computer software for the creation of firewalls; computer software for two or three-dimensional simulation for use in design and development of industrial products; computer software for use as a spreadsheet; computer software for use in cancer diagnosis; computer software for use in controlling and improving computer processing speed; computer software for use in creating and designing web sites; computer software for use in database management; computer software for use in generating streaming advertisements on the web sites of others; computer software for use in managing and controlling production schedules, shipping schedules, purchase of materials, inventories and accounts; computer software for use in processing semiconductor wafers; computer software for use in programming facsimile machines; computer software for use in providing multiple user access to a global computer information network; computer software for use in the encryption and decryption of digital files; computer software for use in the management of payroll; computer software for validating address and zone information; computer software for video editing; computer software for visual art designing and editing; computer software for word processing; computer software that allows transmission of graphics to mobile telephones; computer software that provides real-time, integrated business management intelligence by combining information from various databases; computer software to allow users to perform electronic payment transactions; computer software to automate data warehousing; computer software to calculate and charge sales tax and to create reports to pay sales tax to appropriate tax agencies; computer software to create and manage budgets; computer software to create price quote estimates and transfer price quote estimates to invoices; contact lenses; covers for tablet computers; credit card encoding machines; desktop computers; dish aerials; door chimes; DVD burners; DVD cases; DVD drives; DVD players; DVD recorders; DVD sleeves; DVDs containing instruction manuals in welding; DVDs containing movie recordings; DVDs containing recordings of television shows and movies; electric batteries for cameras; electric batteries for portable computers; electric batteries for powering electric vehicles; electric batteries for smartphones; electric batteries for tablet computers; electric batteries for vehicles; electric batteries for watches; electric buzzers; electric cable connectors; electric cables; electric door chimes; electronic ballasts for lamps; electronic door locks; electronic lock assemblies; electronic sensors for measuring solar radiation; encoded bank cards; encoded bar code labels; encoded credit cards; encoded debit cards; encoded electronic chip cards for identifying particular users of computers and cell phones; encoded electronic chip cards for identifying particular users of computers and mobile phones; encoded gift cards; encoded identity cards; encoded key cards; encoded key cards, namely, encoded identity cards, identification cards with embedded chips, identification smart cards; encoded magnetic identification bracelets; encoded prepaid credit cards; eyeglass mountings; flash lamps for cameras; flash lamps for photography; fuel level indicators for vehicles; head mounted audio-visual display units containing integrated cameras and sensors; head mounted displays; headsets; helmet camera mounts; infrared sensors; integrated circuit modules; keyboards for cellular telephones; keyboards for computers; lanyards for holding encoded identity cards; laser diode modules; lcd monitors; LED displays; led monitors; LED position sensors; lens filters for cameras; light-emitting diode [LED] microscopes; light-emitting diode [LED] monitors; light-emitting diode [LED] televisions; light-emitting diodes [LED]; liquid crystal display (LCD) televisions; liquid crystal display monitors; liquid level sensors; long distance telephone calling cards, magnetically encoded; loud speakers; magnetic encoded card readers; magnetic encoded identification bracelets; magnetic mount flashing safety lights for vehicles; magnetically encoded bank cards; magnetically encoded card readers; magnetically encoded credit cards; magnetically encoded debit cards; magnetically encoded gift cards; magnetically encoded hotel room key cards;

magnetically encoded identification bracelets; magnetically encoded identification cards; magnetically encoded phone cards; metal detectors; mobile phone chargers; motion detectors; motion sensors; motion sensors for security lights; mounting racks adapted for computer hardware; mounting racks for computer hardware; mounts for helmet cameras; mounts for smartphones; oil level indicators for vehicles; oil level sensors; optical sensors; phase indicators; photovoltaic cells and modules; photovoltaic modules; pince-nez mountings; pollutant sensors; pre-paid telephone calling cards, magnetically encoded; pressure sensors; protective cases for smartphones; protective face-shields for protective helmets; proximity sensors; radio aerials; radio antennas; radio signal antennas; rectifier modules; satellite aerials; sensors for determining acceleration; sensors for determining temperature; sensors for determining velocity; slide film mounts; smartphone mounts; speaker mounting brackets; subscriber identification module (SIM) card; tablet computers; television aerials; temperature sensors; thermal sensors; timing sensors; USB cables; USB chargers; USB flash drives; velocity sensors; vibration sensors for installation in wind mill housings; vibration sensors for installation in windmill housings; video cards; video cassette recorders; video monitors; video recorders; virtual reality head-mounted video displays for use in playing video games; wearable video display monitors; wireless audio speakers; wireless headsets for smartphones; wireless routers

### **Class 11**

(2) air purifiers for household purposes; barbecue grills; barbecues; barbecues and grills; bathtubs; bicycle lamps; bicycle lights; book lights; bread baking machines; bread machines; candle lanterns; ceiling lights; charcoal roasters for household purposes; cooking grills; desk lamps; disinfectant dispensers for toilets; disinfectant distributors for toilets; dispensing units for room deodorant; electric grills; electric lamps; facial steamers; faucets; hair dryers; humidifiers; industrial air purifiers; irrigation sprinklers; lamp bulbs; lanterns; LED flashlights; led landscape lights; led light bulbs; light bulbs; lighting fixtures; lights for vehicles; mercury lamps; nail lamps; portable electric fans; portable electric heaters; portable evaporative air coolers; portable foot baths; portable headlamps; portable paper lanterns [chochin]; range hoods; reading lights; showerheads; solar powered lamps; sprinkler systems for lawn irrigation; steam accumulators; steam cookers; steam generating installations; steam generators; steam reformers for use in generating hydrogen gas; steam superheaters for industrial purposes; stoves; street lights; string lights for festive decoration; tail lights for vehicles; toilet bowls; toilet seats; ultraviolet (UV) lamps for use in disinfecting surfaces; ultraviolet light (UV) water purification device; ultraviolet sterilizers for water treatment; valves for lawn sprinkler systems; water fountains

**Application Number** 2,128,857  
**Language of Application** English

**Filing Date** 2021-08-24

## APPLICANT AND AGENT DETAILS

### Applicant

Haijun Luo  
No. 23, Zhoushang, Fishery Village, Quanjian  
Town, Suichuan County,  
Ji'an City, Jiangxi Province, 518000  
CHINA

### Agent

XIN XU  
(Fang An Law PC), Suite 300 & 306, 5500  
North Service Rd., Burlington, ONTARIO,  
L7L6W6

## TRADEMARK DETAILS

# HUAOU

### Trademark Type

Standard Characters

### Goods

#### Class 09

(1) adapter plugs; anti-glare filters for computer monitors; anti-glare filters for televisions and computer monitors; arm rests for use with computers; augmented reality computer games for use on cellular phones; augmented reality computer games for use on mobile phones; augmented reality computer games for use on notebook computers; augmented reality computer games for use on personal computers; augmented reality computer games for use on smart phones; augmented reality computer games for use on tablet computers; augmented reality software for playing computer games; automatic altitude indicators; automatic answering machines; automatic cash dispensers; automatic cash registers; automatic cash sorting and counting machines; automatic chromatography apparatus for laboratory use; automatic controllers for revolving doors; automatic indicators of low pressure in tires; automatic indicators of low pressure in tyres; automatic indicators of low pressure in vehicle tires; automatic indicators of low pressure in vehicle tyres; automatic ion-exchange chromatography apparatus for laboratory use; automatic money counting and money changing machines; automatic solar tracking sensors; batteries and battery chargers for notebook computers; blank computer discs; blank discs for computers; blank floppy computer discs; blank hard disks for computers; blank USB flash drives; cameras; car antennas; car navigation computers; car videorecorders; carbon dioxide detectors; carbon monoxide detectors; card readers for magnetically encoded cards; carrying cases adapted for computers; carrying cases for notebook computers; carrying cases specially adapted for computer printers; cases adapted for computers; cases adapted for netbook computers; cases adapted for notebook computers; cases for smartphones; cases for tablet computers; CD cases; CD drives for computers; CD-ROMs containing computer games; cell phone antennas; cheque encoding machines; clock generators for computers; communications computers; compact disc drives for computers; compact discs containing computer games; computer accelerator boards; computer anti-virus software; computer application software for handheld computers that allows users to access and browse online profiles of pet care service providers; computer application software for mobile phones for use in database management; computer application software for mobile phones that allows users to access and browse online profiles of pet care service providers; computer application software for tablet devices that allows users to access and browse online profiles of pet

care service providers; computer application software in playing video and computer games; computer bags; computer buffers; computer cables; computer card adapters; computer carrying cases; computer cases; computer central processing units; computer chassis; computer chips; computer chipsets for use in transmitting data to and from a central processing unit; computer communications software to allow customers to access bank account information and transact bank business; computer daughterboards; computer disc drives; computer disk/disc drives; computer display monitors; computer display screens; computer e-commerce software to allow users to perform electronic business transactions via a global computer network; computer expansion boards; computer fax modem cards; computer fingerprint imaging software; computer fingerprint scanning software; computer game cartridges; computer game cartridges and discs; computer game cassettes; computer game programmes; computer game programs; computer game software; computer game software for game machines; computer game software for playing online betting games; computer game software for playing online casino games; computer game software for playing online gambling games; computer game software for playing online games of skill; computer game software for playing online prize games; computer game software for use on cellular phones; computer game software for use on mobile phones; computer game tapes; computer games; computer games downloadable from a global computer network; computer games for use on gaming machines; computer games for use on mobile and cellular phones; computer games for use on notebook computers; computer games for use on personal computers; computer games for use on slot machines; computer games for use on tablet computers; computer games for use on video lottery terminals; computer games in the field of basketball; computer graphics boards; computer graphics cards; computer hardware; computer hardware and computer software for database management; computer hardware and software for database management; computer hardware and software for setting up and configuring local area networks; computer hardware for data processing; computer hardware for network access servers; computer hardware for telecommunications; computer heat sinks; computer interface boards; computer interface cards; computer joysticks; computer keyboards; computer keypads; computer memory expansion modules; computer mice; computer monitor frames; computer monitors; computer motherboards; computer motherboards and daughterboards; computer mouse; computer mouse mats; computer mouse pads; computer network adapters; computer network adaptors; computer network bridges; computer network hubs; computer network hubs, switches and routers; computer network routers; computer network server; computer network switches; computer network-attached storage [NAS] hardware; computer networking hardware; computer operating programmes; computer operating programs; computer operating recorded programs; computer operating system software; computer operating systems; computer parallel ports; computer power supplies; computer printers; computer programmes for document management; computer programs (cad/cam) recorded on software designed for use in construction and automated manufacturing; computer programs and computer software for electronic trading of securities; computer programs and software for image processing; computer programs featuring badges for use in online virtual worlds; computer programs featuring characters for use in online virtual worlds; computer programs featuring clothes and accessories for use in online virtual worlds; computer programs featuring emojis for use in online virtual worlds; computer programs featuring stickers for use in online virtual worlds; computer programs for connecting to remote computers and computer networks; computer programs for editing images, sound and video; computer programs for language translations and training; computer programs for network management; computer programs for processing digital music files; computer programs for searching remotely for content on computers and computer networks; computer programs for searching the contents of computers and computer networks by remote control; computer programs for use in electronic commerce for processing electronic payments and authenticating the identity of payers; computer programs for using the Internet and

the World Wide Web; computer programs used for electronic cash register systems; computer scanners; computer screen filters; computer screen saver software; computer screen saver software, recorded or downloadable; computer screens; computer screensaver software; computer search engine software; computer serial ports; computer servers; computer skins, namely, fitted plastic film for covering and providing a scratch proof barrier for computers; computer software and databases for use in diagnosis, repair and configuration of computers; computer software and firmware for playing games of chance on dedicated gaming consoles; computer software and firmware for playing games of chance on reel based slot machines; computer software and firmware for playing games of chance on video based slot machines; computer software and firmware for playing games of chance on video lottery terminals; computer software featuring mathematical algorithms and indices for use in analyzing and evaluating dairy cow health and productivity; computer software for accessing, browsing and searching online databases; computer software for administering employee payroll; computer software for administration of computer local area networks; computer software for application and database integration; computer software for assisting developers in creating program code for use in mobile internet applications and client interfaces; computer software for assisting developers in creating program code for use in multiple application programs; computer software for authorising access to databases; computer software for computer-aided design/computer-aided manufacturing [CAD/CAM]; computer software for contact tracing and tracking of COVID-19 and other infectious diseases; computer software for controlling and managing access server applications; computer software for controlling and managing patient medical information; computer software for controlling and operating laser rangefinders; computer software for converting document images into electronic formats; computer software for creating and editing music; computer software for creating and editing music and sounds; computer software for creating and inserting metatags into documents and information; computer software for creating computer games; computer software for creating searchable databases; computer software for creating searchable databases of information and data; computer software for creating video games; computer software for creating, sending and receiving e-mail; computer software for data deduplication; computer software for data security; computer software for database management; computer software for digital animation and special effects of images; computer software for displaying orders and driver locations on maps; computer software for document management; computer software for editing images, sound, and video; computer software for editing music and for editing digital audio recordings; computer software for fingerprint imaging; computer software for fingerprint scanning; computer software for global positioning systems; computer software for graphic designing and editing; computer software for image processing; computer software for inventory management; computer software for language training; computer software for language translations; computer software for logistics, namely, software for tracking documents, packages and freight; computer software for managing retail store customer accounts; computer software for mathematical calculation; computer software for medical imaging; computer software for monitoring computer network access and activity; computer software for oil and gas reservoir analysis; computer software for operating computer games on the internet; computer software for operating system programs; computer software for optical character recognition; computer software for organising food recipes, monitoring calorie intake, and weigh control; computer software for organizing and viewing digital images and photographs; computer software for predictive and corrective text entry for use with smart phones, tablet computers and personal digital assistants; computer software for processing digital images; computer software for processing digital music files; computer software for project management; computer software for providing an on-line database in the field of transaction processing to upload transactional data, provide statistical analysis, and produce notifications and reports; computer software for running computer games on the internet; computer software for running development

programs and application programs in a common development environment; computer software for scanning, digitizing, altering and retouching of photographs; computer software for text editing; computer software for the collection of statistical production data for oil and gas field operations; computer software for the creation of firewalls; computer software for two or three-dimensional simulation for use in design and development of industrial products; computer software for use as a spreadsheet; computer software for use in cancer diagnosis; computer software for use in controlling and improving computer processing speed; computer software for use in creating and designing web sites; computer software for use in database management; computer software for use in generating streaming advertisements on the web sites of others; computer software for use in managing and controlling production schedules, shipping schedules, purchase of materials, inventories and accounts; computer software for use in processing semiconductor wafers; computer software for use in programming facsimile machines; computer software for use in providing multiple user access to a global computer information network; computer software for use in the encryption and decryption of digital files; computer software for use in the management of payroll; computer software for validating address and zone information; computer software for video editing; computer software for visual art designing and editing; computer software for word processing; computer software that allows transmission of graphics to mobile telephones; computer software that provides real-time, integrated business management intelligence by combining information from various databases; computer software to allow users to perform electronic payment transactions; computer software to automate data warehousing; computer software to calculate and charge sales tax and to create reports to pay sales tax to appropriate tax agencies; computer software to create and manage budgets; computer software to create price quote estimates and transfer price quote estimates to invoices; contact lenses; covers for tablet computers; credit card encoding machines; desktop computers; dish aerials; door chimes; DVD burners; DVD cases; DVD drives; DVD players; DVD recorders; DVD sleeves; DVDs containing instruction manuals in welding; DVDs containing movie recordings; DVDs containing recordings of television shows and movies; electric batteries for cameras; electric batteries for portable computers; electric batteries for powering electric vehicles; electric batteries for smartphones; electric batteries for tablet computers; electric batteries for vehicles; electric batteries for watches; electric buzzers; electric cable connectors; electric cables; electric door chimes; electronic ballasts for lamps; electronic door locks; electronic lock assemblies; electronic sensors for measuring solar radiation; encoded bank cards; encoded bar code labels; encoded credit cards; encoded debit cards; encoded electronic chip cards for identifying particular users of computers and cell phones; encoded electronic chip cards for identifying particular users of computers and mobile phones; encoded gift cards; encoded identity cards; encoded key cards; encoded key cards, namely, encoded identity cards, identification cards with embedded chips, identification smart cards; encoded magnetic identification bracelets; encoded prepaid credit cards; eyeglass mountings; flash lamps for cameras; flash lamps for photography; fuel level indicators for vehicles; head mounted audio-visual display units containing integrated cameras and sensors; head mounted displays; headsets; helmet camera mounts; infrared sensors; integrated circuit modules; keyboards for cellular telephones; keyboards for computers; lanyards for holding encoded identity cards; laser diode modules; lcd monitors; LED displays; led monitors; LED position sensors; lens filters for cameras; light-emitting diode [LED] microscopes; light-emitting diode [LED] monitors; light-emitting diode [LED] televisions; light-emitting diodes [LED]; liquid crystal display (LCD) televisions; liquid crystal display monitors; liquid level sensors; long distance telephone calling cards, magnetically encoded; loud speakers; magnetic encoded card readers; magnetic encoded identification bracelets; magnetic mount flashing safety lights for vehicles; magnetically encoded bank cards; magnetically encoded card readers; magnetically encoded credit cards; magnetically encoded debit cards; magnetically encoded gift cards; magnetically encoded hotel room key cards;



magnetically encoded identification bracelets; magnetically encoded identification cards; magnetically encoded phone cards; metal detectors; mobile phone chargers; motion detectors; motion sensors; motion sensors for security lights; mounting racks adapted for computer hardware; mounting racks for computer hardware; mounts for helmet cameras; mounts for smartphones; oil level indicators for vehicles; oil level sensors; optical sensors; phase indicators; photovoltaic cells and modules; photovoltaic modules; pince-nez mountings; pollutant sensors; pre-paid telephone calling cards, magnetically encoded; pressure sensors; protective cases for smartphones; protective face-shields for protective helmets; proximity sensors; radio aerials; radio antennas; radio signal antennas; rectifier modules; satellite aerials; sensors for determining acceleration; sensors for determining temperature; sensors for determining velocity; slide film mounts; smartphone mounts; speaker mounting brackets; subscriber identification module (SIM) card; tablet computers; television aerials; temperature sensors; thermal sensors; timing sensors; USB cables; USB chargers; USB flash drives; velocity sensors; vibration sensors for installation in wind mill housings; vibration sensors for installation in windmill housings; video cards; video cassette recorders; video monitors; video recorders; virtual reality head-mounted video displays for use in playing video games; wearable video display monitors; wireless audio speakers; wireless headsets for smartphones; wireless routers

### **Class 11**

(2) air purifiers for household purposes; barbecue grills; barbecues; barbecues and grills; bathtubs; bicycle lamps; bicycle lights; book lights; bread baking machines; bread machines; candle lanterns; ceiling lights; charcoal roasters for household purposes; cooking grills; desk lamps; disinfectant dispensers for toilets; disinfectant distributors for toilets; dispensing units for room deodorant; electric grills; electric lamps; facial steamers; faucets; hair dryers; humidifiers; industrial air purifiers; irrigation sprinklers; lamp bulbs; lanterns; LED flashlights; led landscape lights; led light bulbs; light bulbs; lighting fixtures; lights for vehicles; mercury lamps; nail lamps; portable electric fans; portable electric heaters; portable evaporative air coolers; portable foot baths; portable headlamps; portable paper lanterns [chochin]; range hoods; reading lights; showerheads; solar powered lamps; sprinkler systems for lawn irrigation; steam accumulators; steam cookers; steam generating installations; steam generators; steam reformers for use in generating hydrogen gas; steam superheaters for industrial purposes; stoves; street lights; string lights for festive decoration; tail lights for vehicles; toilet bowls; toilet seats; ultraviolet (UV) lamps for use in disinfecting surfaces; ultraviolet light (UV) water purification device; ultraviolet sterilizers for water treatment; valves for lawn sprinkler systems; water fountains

**Application Number** 2,128,858  
**Language of Application** English

**Filing Date** 2021-08-24

## APPLICANT AND AGENT DETAILS

### Applicant

Haijun Luo  
No. 23, Zhoushang, Fishery Village, Quanjian  
Town, Suichuan County,  
Ji'an City, Jiangxi Province, 518000  
CHINA

### Agent

XIN XU  
(Fang An Law PC), Suite 300 & 306, 5500  
North Service Rd., Burlington, ONTARIO,  
L7L6W6

## TRADEMARK DETAILS

# IICAI

### Trademark Type

Standard Characters

### Goods

#### Class 09

(1) adapter plugs; anti-glare filters for computer monitors; anti-glare filters for televisions and computer monitors; arm rests for use with computers; augmented reality computer games for use on cellular phones; augmented reality computer games for use on mobile phones; augmented reality computer games for use on notebook computers; augmented reality computer games for use on personal computers; augmented reality computer games for use on smart phones; augmented reality computer games for use on tablet computers; augmented reality software for playing computer games; automatic altitude indicators; automatic answering machines; automatic cash dispensers; automatic cash registers; automatic cash sorting and counting machines; automatic chromatography apparatus for laboratory use; automatic controllers for revolving doors; automatic indicators of low pressure in tires; automatic indicators of low pressure in tyres; automatic indicators of low pressure in vehicle tires; automatic indicators of low pressure in vehicle tyres; automatic ion-exchange chromatography apparatus for laboratory use; automatic money counting and money changing machines; automatic solar tracking sensors; batteries and battery chargers for notebook computers; blank computer discs; blank discs for computers; blank floppy computer discs; blank hard disks for computers; blank USB flash drives; cameras; car antennas; car navigation computers; car videorecorders; carbon dioxide detectors; carbon monoxide detectors; card readers for magnetically encoded cards; carrying cases adapted for computers; carrying cases for notebook computers; carrying cases specially adapted for computer printers; cases adapted for computers; cases adapted for netbook computers; cases adapted for notebook computers; cases for smartphones; cases for tablet computers; CD cases; CD drives for computers; CD-ROMs containing computer games; cell phone antennas; cheque encoding machines; clock generators for computers; communications computers; compact disc drives for computers; compact discs containing computer games; computer accelerator boards; computer anti-virus software; computer application software for handheld computers that allows users to access and browse online profiles of pet care service providers; computer application software for mobile phones for use in database management; computer application software for mobile phones that allows users to access and browse online profiles of pet care service providers; computer application software for tablet devices that allows users to access and browse online profiles of pet

care service providers; computer application software in playing video and computer games; computer bags; computer buffers; computer cables; computer card adapters; computer carrying cases; computer cases; computer central processing units; computer chassis; computer chips; computer chipsets for use in transmitting data to and from a central processing unit; computer communications software to allow customers to access bank account information and transact bank business; computer daughterboards; computer disc drives; computer disk/disc drives; computer display monitors; computer display screens; computer e-commerce software to allow users to perform electronic business transactions via a global computer network; computer expansion boards; computer fax modem cards; computer fingerprint imaging software; computer fingerprint scanning software; computer game cartridges; computer game cartridges and discs; computer game cassettes; computer game programmes; computer game programs; computer game software; computer game software for game machines; computer game software for playing online betting games; computer game software for playing online casino games; computer game software for playing online gambling games; computer game software for playing online games of skill; computer game software for playing online prize games; computer game software for use on cellular phones; computer game software for use on mobile phones; computer game tapes; computer games; computer games downloadable from a global computer network; computer games for use on gaming machines; computer games for use on mobile and cellular phones; computer games for use on notebook computers; computer games for use on personal computers; computer games for use on slot machines; computer games for use on tablet computers; computer games for use on video lottery terminals; computer games in the field of basketball; computer graphics boards; computer graphics cards; computer hardware; computer hardware and computer software for database management; computer hardware and software for database management; computer hardware and software for setting up and configuring local area networks; computer hardware for data processing; computer hardware for network access servers; computer hardware for telecommunications; computer heat sinks; computer interface boards; computer interface cards; computer joysticks; computer keyboards; computer keypads; computer memory expansion modules; computer mice; computer monitor frames; computer monitors; computer motherboards; computer motherboards and daughterboards; computer mouse; computer mouse mats; computer mouse pads; computer network adapters; computer network adaptors; computer network bridges; computer network hubs; computer network hubs, switches and routers; computer network routers; computer network server; computer network switches; computer network-attached storage [NAS] hardware; computer networking hardware; computer operating programmes; computer operating programs; computer operating recorded programs; computer operating system software; computer operating systems; computer parallel ports; computer power supplies; computer printers; computer programmes for document management; computer programs (cad/cam) recorded on software designed for use in construction and automated manufacturing; computer programs and computer software for electronic trading of securities; computer programs and software for image processing; computer programs featuring badges for use in online virtual worlds; computer programs featuring characters for use in online virtual worlds; computer programs featuring clothes and accessories for use in online virtual worlds; computer programs featuring emojis for use in online virtual worlds; computer programs featuring stickers for use in online virtual worlds; computer programs for connecting to remote computers and computer networks; computer programs for editing images, sound and video; computer programs for language translations and training; computer programs for network management; computer programs for processing digital music files; computer programs for searching remotely for content on computers and computer networks; computer programs for searching the contents of computers and computer networks by remote control; computer programs for use in electronic commerce for processing electronic payments and authenticating the identity of payers; computer programs for using the Internet and

the World Wide Web; computer programs used for electronic cash register systems; computer scanners; computer screen filters; computer screen saver software; computer screen saver software, recorded or downloadable; computer screens; computer screensaver software; computer search engine software; computer serial ports; computer servers; computer skins, namely, fitted plastic film for covering and providing a scratch proof barrier for computers; computer software and databases for use in diagnosis, repair and configuration of computers; computer software and firmware for playing games of chance on dedicated gaming consoles; computer software and firmware for playing games of chance on reel based slot machines; computer software and firmware for playing games of chance on video based slot machines; computer software and firmware for playing games of chance on video lottery terminals; computer software featuring mathematical algorithms and indices for use in analyzing and evaluating dairy cow health and productivity; computer software for accessing, browsing and searching online databases; computer software for administering employee payroll; computer software for administration of computer local area networks; computer software for application and database integration; computer software for assisting developers in creating program code for use in mobile internet applications and client interfaces; computer software for assisting developers in creating program code for use in multiple application programs; computer software for authorising access to databases; computer software for computer-aided design/computer-aided manufacturing [CAD/CAM]; computer software for contact tracing and tracking of COVID-19 and other infectious diseases; computer software for controlling and managing access server applications; computer software for controlling and managing patient medical information; computer software for controlling and operating laser rangefinders; computer software for converting document images into electronic formats; computer software for creating and editing music; computer software for creating and editing music and sounds; computer software for creating and inserting metatags into documents and information; computer software for creating computer games; computer software for creating searchable databases; computer software for creating searchable databases of information and data; computer software for creating video games; computer software for creating, sending and receiving e-mail; computer software for data deduplication; computer software for data security; computer software for database management; computer software for digital animation and special effects of images; computer software for displaying orders and driver locations on maps; computer software for document management; computer software for editing images, sound, and video; computer software for editing music and for editing digital audio recordings; computer software for fingerprint imaging; computer software for fingerprint scanning; computer software for global positioning systems; computer software for graphic designing and editing; computer software for image processing; computer software for inventory management; computer software for language training; computer software for language translations; computer software for logistics, namely, software for tracking documents, packages and freight; computer software for managing retail store customer accounts; computer software for mathematical calculation; computer software for medical imaging; computer software for monitoring computer network access and activity; computer software for oil and gas reservoir analysis; computer software for operating computer games on the internet; computer software for operating system programs; computer software for optical character recognition; computer software for organising food recipes, monitoring calorie intake, and weigh control; computer software for organizing and viewing digital images and photographs; computer software for predictive and corrective text entry for use with smart phones, tablet computers and personal digital assistants; computer software for processing digital images; computer software for processing digital music files; computer software for project management; computer software for providing an on-line database in the field of transaction processing to upload transactional data, provide statistical analysis, and produce notifications and reports; computer software for running computer games on the internet; computer software for running development

programs and application programs in a common development environment; computer software for scanning, digitizing, altering and retouching of photographs; computer software for text editing; computer software for the collection of statistical production data for oil and gas field operations; computer software for the creation of firewalls; computer software for two or three-dimensional simulation for use in design and development of industrial products; computer software for use as a spreadsheet; computer software for use in cancer diagnosis; computer software for use in controlling and improving computer processing speed; computer software for use in creating and designing web sites; computer software for use in database management; computer software for use in generating streaming advertisements on the web sites of others; computer software for use in managing and controlling production schedules, shipping schedules, purchase of materials, inventories and accounts; computer software for use in processing semiconductor wafers; computer software for use in programming facsimile machines; computer software for use in providing multiple user access to a global computer information network; computer software for use in the encryption and decryption of digital files; computer software for use in the management of payroll; computer software for validating address and zone information; computer software for video editing; computer software for visual art designing and editing; computer software for word processing; computer software that allows transmission of graphics to mobile telephones; computer software that provides real-time, integrated business management intelligence by combining information from various databases; computer software to allow users to perform electronic payment transactions; computer software to automate data warehousing; computer software to calculate and charge sales tax and to create reports to pay sales tax to appropriate tax agencies; computer software to create and manage budgets; computer software to create price quote estimates and transfer price quote estimates to invoices; contact lenses; covers for tablet computers; credit card encoding machines; desktop computers; dish aerials; door chimes; DVD burners; DVD cases; DVD drives; DVD players; DVD recorders; DVD sleeves; DVDs containing instruction manuals in welding; DVDs containing movie recordings; DVDs containing recordings of television shows and movies; electric batteries for cameras; electric batteries for portable computers; electric batteries for powering electric vehicles; electric batteries for smartphones; electric batteries for tablet computers; electric batteries for vehicles; electric batteries for watches; electric buzzers; electric cable connectors; electric cables; electric door chimes; electronic ballasts for lamps; electronic door locks; electronic lock assemblies; electronic sensors for measuring solar radiation; encoded bank cards; encoded bar code labels; encoded credit cards; encoded debit cards; encoded electronic chip cards for identifying particular users of computers and cell phones; encoded electronic chip cards for identifying particular users of computers and mobile phones; encoded gift cards; encoded identity cards; encoded key cards; encoded key cards, namely, encoded identity cards, identification cards with embedded chips, identification smart cards; encoded magnetic identification bracelets; encoded prepaid credit cards; eyeglass mountings; flash lamps for cameras; flash lamps for photography; fuel level indicators for vehicles; head mounted audio-visual display units containing integrated cameras and sensors; head mounted displays; headsets; helmet camera mounts; infrared sensors; integrated circuit modules; keyboards for cellular telephones; keyboards for computers; lanyards for holding encoded identity cards; laser diode modules; lcd monitors; LED displays; led monitors; LED position sensors; lens filters for cameras; light-emitting diode [LED] microscopes; light-emitting diode [LED] monitors; light-emitting diode [LED] televisions; light-emitting diodes [LED]; liquid crystal display (LCD) televisions; liquid crystal display monitors; liquid level sensors; long distance telephone calling cards, magnetically encoded; loud speakers; magnetic encoded card readers; magnetic encoded identification bracelets; magnetic mount flashing safety lights for vehicles; magnetically encoded bank cards; magnetically encoded card readers; magnetically encoded credit cards; magnetically encoded debit cards; magnetically encoded gift cards; magnetically encoded hotel room key cards;

magnetically encoded identification bracelets; magnetically encoded identification cards; magnetically encoded phone cards; metal detectors; mobile phone chargers; motion detectors; motion sensors; motion sensors for security lights; mounting racks adapted for computer hardware; mounting racks for computer hardware; mounts for helmet cameras; mounts for smartphones; oil level indicators for vehicles; oil level sensors; optical sensors; phase indicators; photovoltaic cells and modules; photovoltaic modules; pince-nez mountings; pollutant sensors; pre-paid telephone calling cards, magnetically encoded; pressure sensors; protective cases for smartphones; protective face-shields for protective helmets; proximity sensors; radio aerials; radio antennas; radio signal antennas; rectifier modules; satellite aerials; sensors for determining acceleration; sensors for determining temperature; sensors for determining velocity; slide film mounts; smartphone mounts; speaker mounting brackets; subscriber identification module (SIM) card; tablet computers; television aerials; temperature sensors; thermal sensors; timing sensors; USB cables; USB chargers; USB flash drives; velocity sensors; vibration sensors for installation in wind mill housings; vibration sensors for installation in windmill housings; video cards; video cassette recorders; video monitors; video recorders; virtual reality head-mounted video displays for use in playing video games; wearable video display monitors; wireless audio speakers; wireless headsets for smartphones; wireless routers

### **Class 11**

(2) air purifiers for household purposes; barbecue grills; barbecues; barbecues and grills; bathtubs; bicycle lamps; bicycle lights; book lights; bread baking machines; bread machines; candle lanterns; ceiling lights; charcoal roasters for household purposes; cooking grills; desk lamps; disinfectant dispensers for toilets; disinfectant distributors for toilets; dispensing units for room deodorant; electric grills; electric lamps; facial steamers; faucets; hair dryers; humidifiers; industrial air purifiers; irrigation sprinklers; lamp bulbs; lanterns; LED flashlights; led landscape lights; led light bulbs; light bulbs; lighting fixtures; lights for vehicles; mercury lamps; nail lamps; portable electric fans; portable electric heaters; portable evaporative air coolers; portable foot baths; portable headlamps; portable paper lanterns [chochin]; range hoods; reading lights; showerheads; solar powered lamps; sprinkler systems for lawn irrigation; steam accumulators; steam cookers; steam generating installations; steam generators; steam reformers for use in generating hydrogen gas; steam superheaters for industrial purposes; stoves; street lights; string lights for festive decoration; tail lights for vehicles; toilet bowls; toilet seats; ultraviolet (UV) lamps for use in disinfecting surfaces; ultraviolet light (UV) water purification device; ultraviolet sterilizers for water treatment; valves for lawn sprinkler systems; water fountains

**Application Number** 2,128,860  
**Language of Application** English

**Filing Date** 2021-08-24

## **APPLICANT DETAILS**

**Applicant**  
WONGSMART INC  
805 W Duarte Rd #107  
Arcadia, CA 91007  
UNITED STATES OF AMERICA

## **TRADEMARK DETAILS**

# **Bolivelan**

**Trademark Type**  
Standard Characters

**Goods**

**Class 25**

panties; skirts

**Application Number** 2,128,862  
**Language of Application** English

**Filing Date** 2021-08-24

## APPLICANT DETAILS

### Applicant

Litime LLC  
4610 South Ulster Street, Suite 150  
Denver, CO 80237  
UNITED STATES OF AMERICA

## TRADEMARK DETAILS

# LITIME

### Trademark Type

Standard Characters

### Services

#### Class 35

online department store services; online retail department store services; online sales of arts and crafts; online sales of automobile parts; online sales of clothing; online sales of cosmetics; online sales of footwear; online sales of housewares; online sales of lingerie; online sales of photographic equipment; online sales of sporting goods; online sales of toys



**Application Number** 2,128,869  
**Language of Application** English

**Filing Date** 2021-08-24

## APPLICANT DETAILS

### Applicant

InfoCepts Technologies, Inc  
C/O TMF CANADA INC.  
777 DUNSMUIR STREET,  
SUITE 1700,  
VANCOUVER  
BRITISH COLUMBIA  
V7Y1K4

## TRADEMARK DETAILS

# INFOCEPTS

### Trademark Type

Standard Characters

### Services

#### Class 35

(1) analysis of market research data and statistics; business intelligence reporting; business management services relating to information and data compiling and analyzing; updating and maintenance of data in computer databases

#### Class 42

(2) application service provider featuring application programming interface (api) software for analyzing market data; application service provider featuring application programming interface (api) software for gathering market data; cloud computing provider services for general storage of data; computer programming services; computer programming services for commercial analysis and reporting; computer programming, coding and decoding; consulting in the field of cloud computing networks and applications; consulting services in the field of software as a service (saas); creating of computer programs for others; data migration services; data mining services; database design and development; database development services; development and creation of computer programmes for data processing; development of data processing programs by order of third parties; updating of software for data processing

**Application Number** 2,128,870  
**Language of Application** English

**Filing Date** 2021-08-24

## APPLICANT DETAILS

### Applicant

HUA DONG HU  
Tangnei Group, Gaoyuan Village, Haotou  
Township, Rucheng County, Chenzhou  
Chenzhou, Hunan  
Rucheng, 424121  
CHINA

## TRADEMARK DETAILS

# looxmeer

### Trademark Type

Standard Characters

### Goods

#### Class 12

air pumps for automobiles; air pumps for bicycles; air pumps for motorcycles; baby strollers; bicycle bells; bicycle carriers; bicycle handlebars; bicycle kickstands; bicycle parts; bicycle pedals; bicycle pumps; bicycle saddles; bicycle seats; bicycle stands; bicycle tires; dining cars; electric bicycles; garden tractors; go-carts; grocery carts; light lorries; pet strollers; rearview mirrors; shopping carts; shopping trolleys; windshield wiper blades

**Application Number** 2,128,898  
**Language of Application** English

**Filing Date** 2021-08-24

## **APPLICANT DETAILS**

### **Applicant**

Madison Almond  
398 Old Wooler Rd  
Codrington  
ONTARIO  
K0K1R0

## **TRADEMARK DETAILS**

### **Trademark Type**

Design

### **Visual Representation**



The logo features the letters 'M', 'K', and 'D' in a large, outlined, sans-serif font. Below the 'K' and 'D' is the word 'brands' in a smaller, lowercase, sans-serif font.

### **Goods**

Class 25

athletic apparel; sports bras

**Application Number** 2,128,932  
**Language of Application** English

**Filing Date** 2021-08-24

## **APPLICANT DETAILS**

### **Applicant**

Artifact Skin Company Inc.  
270 Sherman Ave. North  
Suite 112  
Hamilton  
ONTARIO  
L8L6N4

## **TRADEMARK DETAILS**

# **ARTIFACT BUTTERFLY BLUE CALMING POWER**

### **Trademark Type**

Standard Characters

### **Goods**

#### **Class 03**

body and facial gels [cosmetics]; cosmetic creams and lotions for face and body care; face oils; facial cleansers; facial masks; facial scrubs; lip care preparations; non-medicated skin serums for the face; skin toners

**Application Number** 2,128,933  
**Language of Application** English

**Filing Date** 2021-08-24

## APPLICANT AND AGENT DETAILS

### Applicant

STORYWELL MARKETING INC.  
5721 Mason Rd  
Sechelt  
BRITISH COLUMBIA  
V7Z0N4

### Agent

WITMART INC.  
34 King Street East, Suite 500, Toronto,  
ONTARIO, M5C2X8

## TRADEMARK DETAILS

# Storywell

### Trademark Type

Standard Characters

### Services

#### Class 35

advertising copywriting; advertising the goods and services of others; business marketing consulting services; developing brand strategies for others; providing marketing strategies for others; public relations consultancy; public relations services; search engine optimization; social media strategy consulting

**Application Number** 2,128,970  
**Language of Application** English

**Filing Date** 2021-08-24

## APPLICANT DETAILS

### Applicant

Jacqueline Rowe  
303 13 Ave SW  
SUITE 401  
Calgary  
ALBERTA  
T2R0Y9

## TRADEMARK DETAILS

# Summit Beers Club

### Trademark Type

Standard Characters

### Goods

#### Class 16

(1) stickers

#### Class 25

(2) baseball caps; crew neck sweaters; hoodies; long-sleeved t-shirts; short-sleeved t-shirts; t-shirts; toques

**Application Number** 2,128,977  
**Language of Application** English

**Filing Date** 2021-08-24

## APPLICANT DETAILS

### Applicant

UK HUB LTD  
INTERNATIONAL HOUSE  
24 HOLBORN VIADUCT  
LONDON, EC1A 2BN  
UNITED KINGDOM

## TRADEMARK DETAILS

# MG LTD

### Trademark Type

Standard Characters

### Goods

#### Class 09

35mm cameras; 3D glasses; 3D scanners; 3D spectacles; AA batteries; abacuses; AC to DC converters; AC to DC inverters; acceleration sensors; accelerometers; accounting software; acid hydrometers; acidimeters for batteries; acidometers for batteries; acoustic conduits; acoustic couplers; acoustic meters; acoustic transformers; actinometers; adapter plugs; adapter rings for attaching objectives on cameras; adapter rings for camera lenses; adding machine parts; adding machines



**Application Number** 2,128,988  
**Language of Application** English

**Filing Date** 2021-08-24

## **APPLICANT AND AGENT DETAILS**

### **Applicant**

Smith & Reid Insurance Brokers Ltd.  
100-835 Carling Ave  
Ottawa  
ONTARIO  
K1S2E7

### **Agent**

BRION RAFFOUL  
329 Churchill Ave N, Ottawa, ONTARIO,  
K1Z5B8

## **TRADEMARK DETAILS**

# **SMITH & REID'S INSURANCE TO BUILD ON**

### **Trademark Type**

Standard Characters

### **Services**

#### **Class 36**

insurance services

**Application Number** 2,129,016  
**Language of Application** English

**Filing Date** 2021-08-24

## APPLICANT AND AGENT DETAILS

### Applicant

Yotta Innovation Co., Ltd.  
Level 2, Lotemau Center Building, Vaea Street  
Apia,  
SAMOA

### Agent

FILLMORE RILEY LLP  
1700 - 360 Main Street, Winnipeg, MANITOBA,  
R3C3Z3

## TRADEMARK DETAILS

# HYPERAX

### Trademark Type

Standard Characters

### Goods

#### Class 12

automobile roof containers; automobile roof racks; automobile ski racks; car-top luggage carriers; luggage carriers for vehicles; luggage racks fitted to the bonnet; luggage racks for bicycles; luggage racks for motor cars; roof racks for vehicles; ski racks; ski racks for motor cars

**Application Number** 2,129,020  
**Language of Application** English

**Filing Date** 2021-08-24

## **APPLICANT DETAILS**

### **Applicant**

Megan Camp  
#13-1833 Coast Meridian Road  
Port Coquitlam  
BRITISH COLUMBIA  
V3C6R8

## **TRADEMARK DETAILS**

### **Trademark Type**

Design

### **Visual Representation**

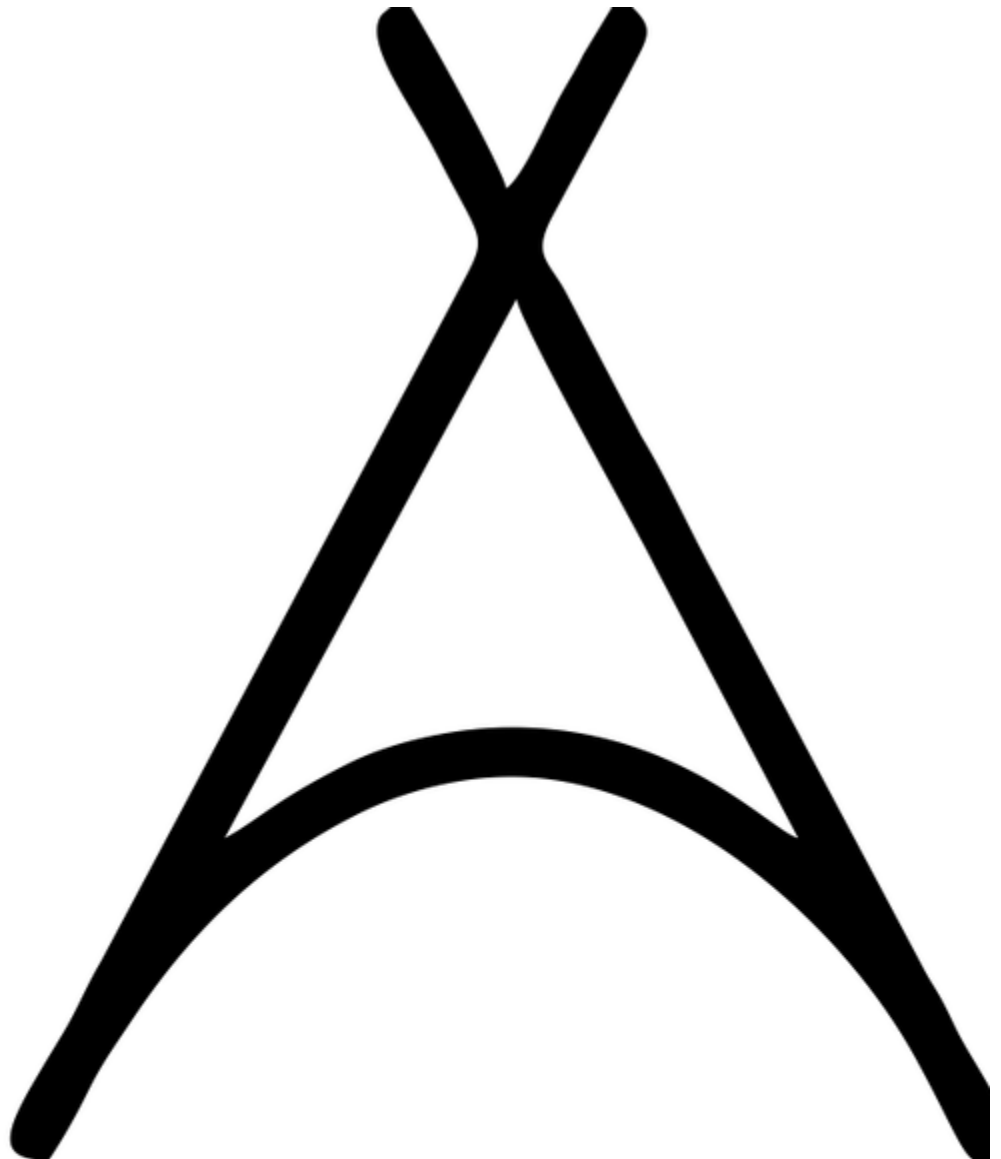

**C** **A** **N** **D** **L** **E** **C**

**C** **A** **N** **D** **L** **E** **C**

**Goods**

**Class 04**

aromatherapy fragrance candles; candles

**Application Number** 2,129,023  
**Language of Application** English

**Filing Date** 2021-08-24

## **APPLICANT DETAILS**

**Applicant**  
CARLOS DA COSTA  
377 Ridelle Ave  
Unit 422  
M6B 1K2  
Toronto  
ONTARIO  
M6B1K2

## **TRADEMARK DETAILS**

**NEWCALLY**

**Trademark Type**  
Standard Characters

**Goods**

**Class 03**  
cosmetic preparations for eye lashes

**Application Number** 2,129,039  
**Language of Application** English

**Filing Date** 2021-08-24

## APPLICANT DETAILS

### Applicant

J and O Beckett LLC  
30 N Gould St  
Suite R  
Sheridan, WY 82801  
UNITED STATES OF AMERICA

## TRADEMARK DETAILS

# Pencil Buddies

### Trademark Type

Standard Characters

### Disclaimer

The right to the exclusive use of the word Pencil is disclaimed apart from the trademark.

### Goods

#### Class 16

artists' pencils; color pencils; colour pencils; pencil boxes; pencil cases; pencil sharpeners; pencils; writing pencils; writing stationery

**Application Number** 2,129,048  
**Language of Application** English

**Filing Date** 2021-08-24

## **APPLICANT AND AGENT DETAILS**

### **Applicant**

Jiangsu Recbio Technology Co., Ltd.  
A217, Vaccine Engineering Center No. 28  
Xinglin Road  
Medical New & High-tech Zone  
Taizhou City, Jiangsu Province, 215300  
CHINA

### **Agent**

PAUL B. BÉLANGER  
4360 av de Hampton, MONTRÉAL, QUEBEC,  
H4A2L2

## **TRADEMARK DETAILS**

### **Trademark Type**

Design

### **Visual Representation**

# **RECBIC**

**Goods****Class 05**

allergy medication; animal feed supplements for veterinary purposes; anti-infective preparations for veterinary purposes; antibiotics for veterinary purposes; bacteriological culture mediums; biocides; biological tissue cultures for medical purposes; biological tissue cultures for veterinary purposes; bouillons for bacteriological cultures; dressings, medical; nutritional supplements for general health and well-being; pharmaceutical products for the treatment of cancer; vaccines for human use; veterinary vaccines



**Application Number** 2,129,053  
**Language of Application** English

**Filing Date** 2021-08-24

## APPLICANT DETAILS

### Applicant

Jufang Zhang  
No. 7, Building 3, Wangdong Village,  
Dongcheng Street, Huangyan District  
Taizhou City, Zhejiang Province, 318020  
CHINA

## TRADEMARK DETAILS

# HCIANO

### Trademark Type

Standard Characters

### Goods

#### Class 09

adapter plugs; automotive battery chargers; batteries and battery chargers for mobile telephones; batteries and battery chargers for notebook computers; burglar alarms; cases for mobile phones; cases for satellite navigation devices; computer chips; computer display screens; computer hardware; computer keyboards; computer mice; digital door locks; ear phones; electric cables; electric connectors; electric control panels; electric locks for vehicles; electric wires; electrical connectors for power converters; electrical ducts; electrical plugs and sockets; hand-held monopod; plug adapters; protective helmets for sports; safety helmets; spectacles, spectacle frames and spectacle cases

**Application Number** 2,129,054  
**Language of Application** English

**Filing Date** 2021-08-24

## APPLICANT DETAILS

### Applicant

Jufang Zhang  
No. 7, Building 3, Wangdong Village,  
Dongcheng Street, Huangyan District  
Taizhou City, Zhejiang Province, 318020  
CHINA

## TRADEMARK DETAILS

# Hotwing

### Trademark Type

Standard Characters

### Goods

#### Class 09

adapter plugs; automotive battery chargers; batteries and battery chargers for mobile telephones; batteries and battery chargers for notebook computers; burglar alarms; cases for mobile phones; cases for satellite navigation devices; computer chips; computer display screens; computer hardware; computer keyboards; computer mice; digital door locks; ear phones; electric cables; electric connectors; electric control panels; electric locks for vehicles; electric wires; electrical connectors for power converters; electrical ducts; electrical plugs and sockets; hand-held monopod; plug adapters; protective helmets for sports; safety helmets; spectacles, spectacle frames and spectacle cases

**Application Number** 2,129,056  
**Language of Application** English

**Filing Date** 2021-08-24

## **APPLICANT DETAILS**

### **Applicant**

Uranian Concepts INC  
96 Isabella St  
15  
Toronto  
ONTARIO  
M4Y1N4

## **TRADEMARK DETAILS**

# **You Can Never Know Too Much.**

### **Trademark Type**

Standard Characters

### **Services**

#### **Class 35**

advertising the goods and services of others via electronic media and specifically the internet

**Application Number** 2,129,104  
**Language of Application** English

**Filing Date** 2021-08-25

## APPLICANT AND AGENT DETAILS

### Applicant

Clam Corporation  
12135 Brockton Lane North  
Rogers, MN 55369  
UNITED STATES OF AMERICA

### Agent

GOWLING WLG (CANADA) LLP  
SUITE 1600, 1 FIRST CANADIAN PLACE, 100  
KING STREET WEST, TORONTO, ONTARIO,  
M5X1G5

## TRADEMARK DETAILS

# CLAMLOCK

### Trademark Type

Standard Characters

### Goods

#### Class 19

(1) fabric-covered portable ice fishing shelters; portable ice fishing houses not of metal; portable ice fishing shelters not of metal;

#### Class 28

(2) fishing reels; fishing rod holders; fishing rods; fishing tackle; fishing tackle bags

### Claims

Priority Filing Date: February 28, 2021, Country or Office: UNITED STATES OF AMERICA,  
Application No: 90551430 in association with the same kind of goods

**Application Number** 2,129,105  
**Language of Application** English

**Filing Date** 2021-08-25

## APPLICANT AND AGENT DETAILS

### Applicant

Clam Corporation  
12135 Brockton Lane North  
Rogers, MN 55369  
UNITED STATES OF AMERICA

### Agent

GOWLING WLG (CANADA) LLP  
SUITE 1600, 1 FIRST CANADIAN PLACE, 100  
KING STREET WEST, TORONTO, ONTARIO,  
M5X1G5

## TRADEMARK DETAILS

### Trademark Type

Design

### Visual Representation



### Goods

#### Class 19

(1) fabric-covered portable ice fishing shelters; portable ice fishing houses not of metal; portable ice fishing shelters not of metal;

#### Class 28

(2) fishing reels; fishing rod holders; fishing rods; fishing tackle; fishing tackle bags

### Claims

Priority Filing Date: February 28, 2021, Country or Office: UNITED STATES OF AMERICA,  
Application No: 90/551476 in association with the same kind of goods

**Application Number** 2,129,150  
**Language of Application** English

**Filing Date** 2021-08-25

## APPLICANT AND AGENT DETAILS

### Applicant

Xue Lin  
Room 2601, Unit 2, Building 2, Youhao  
Mansion,  
No. 2 Fengning Road, Dongfeng Town,  
Zhongshan City, Guangdong, 528414  
CHINA

### Agent

WITMART INC.  
34 King Street East, Suite 500, Toronto,  
ONTARIO, M5C2X8

## TRADEMARK DETAILS

# LPHY

### Trademark Type

Standard Characters

### Goods

#### Class 06

bed casters of metal; common metals, semi-wrought; common metals, unwrought; common metals, unwrought and semi-worked, for further manufacture; fittings of metal for furniture; furniture casters of metal; hardware nails; hardware springs; metal hardware bolts; metal hardware for luggage; metal hardware for mountaineering equipment; metal hardware nuts; metal hardware screws; metal turnbuckles; runners of metal for doors; runners of metal for sliding doors; sash pulleys; window pulleys; window pulleys of metal

**Application Number** 2,129,152  
**Language of Application** English

**Filing Date** 2021-08-25

## APPLICANT AND AGENT DETAILS

**Applicant**

2512110 Ontario Inc.  
10 Pelee Ave  
Kleinburg  
ONTARIO  
L4H3Y2

**Agent**

HEER LAW  
25 Adelaide Street East, Suite 1000, Toronto,  
ONTARIO, M5C3A1

## TRADEMARK DETAILS

# BEHEMOTH BUSINESS GROUP

**Trademark Type**

Standard Characters

**Services**

**Class 39**

delivery of goods by truck; freight forwarding services; freight loading services; freight transportation brokerage; freight transportation by truck; import and export cargo handling services; trucking services

Application Number 2,129,162  
Language of Application English

Filing Date 2021-08-25

## APPLICANT AND AGENT DETAILS

### Applicant

D&L Cafe Holdings Inc.  
706 Bloor Street  
Suite 200  
Toronto  
ONTARIO  
M6G1L4

### Agent

BERESKIN & PARR LLP/S.E.N.C.R.L., S.R.L.  
SCOTIA PLAZA, 40 KING STREET WEST,  
40th FLOOR, TORONTO, ONTARIO, M5H3Y2

## TRADEMARK DETAILS

Trademark Type  
Design

### Visual Representation



### Colour Claim

Colour is claimed as a feature of the trademark. The words "POOP CAFE" are in red, separated by a brown swirled poop design. The seat of the toilet design is beige, topped with a brown swirled poop design and the cherries are red, with brown stems and a green leaf. The design is outlined in black.

### Services



**Class 43**

café services; catering services; restaurant services

**Application Number** 2,129,213  
**Language of Application** English

**Filing Date** 2021-08-25

## **APPLICANT DETAILS**

### **Applicant**

Josephine Lombardi  
31 West 32nd St  
Hamilton  
ONTARIO  
L9C5G7

## **TRADEMARK DETAILS**

# **The Experts in Humanity Project**

### **Trademark Type**

Standard Characters

### **Services**

#### **Class 41**

conducting courses of instruction at the college level; conducting courses of instruction at the high school level; conducting courses of instruction at the primary level

**Application Number** 2,129,218  
**Language of Application** English

**Filing Date** 2021-08-25

## **APPLICANT DETAILS**

**Applicant**  
NORTHLAND CHEMICAL INC.  
7480 Bath Rd  
Mississauga  
ONTARIO  
L4T1L2

## **TRADEMARK DETAILS**

# **NORFLOC**

**Trademark Type**  
Standard Characters

**Services**

**Class 40**

waste water treatment services

**Application Number** 2,129,586  
**Language of Application** English

**Filing Date** 2021-08-25

## **APPLICANT DETAILS**

### **Applicant**

The Better Packaging Co  
Level 501 - 35 High St  
1010  
Auckland, 1011  
NEW ZEALAND

## **TRADEMARK DETAILS**

# **pollastic**

### **Trademark Type**

Standard Characters

### **Goods**

#### **Class 16**

(1) plastic bags for packaging; plastic film for packaging; plastic sheets for packaging

#### **Class 17**

(2) extruded plastics for use in manufacturing

**Application Number** 2,129,602  
**Language of Application** English

**Filing Date** 2021-08-26

## APPLICANT DETAILS

### Applicant

Guangzhen Hong  
Rm 308, 3rd Fl, Bldg D, Tianhui Loft Creative  
Park  
Yuangang, Tianhe Dist  
Guangzhou, Guangdong, 510000  
CHINA

## TRADEMARK DETAILS

# gartful

### Trademark Type

Standard Characters

### Goods

#### Class 17

biodegradable plastic film for agricultural use; garden hoses; packaging bags of rubber; plastic sheeting for preventing weed growth; pouches of rubber for packaging; semi-processed acrylic resins; semi-processed natural resins; semi-processed synthetic resins; semi-processed thermoplastic polymer resins for use in manufacture; synthetic rubber; waterproof packing for shipping container

**Application Number** 2,129,607  
**Language of Application** English

**Filing Date** 2021-08-26

## APPLICANT AND AGENT DETAILS

### Applicant

Yiwu Yichuan Electric Co., Ltd.  
Shop No. 1, 1st Floor, Unit 1, Building 9  
Yongjun Second District, Beiyuan Street  
Yiwu, Zhejiang, 322000  
CHINA

### Agent

PAUL B. BÉLANGER  
4360 av de Hampton, MONTRÉAL, QUEBEC,  
H4A2L2

## TRADEMARK DETAILS

# Dghvin

### Trademark Type

Standard Characters

### Goods

#### Class 08

blades for electric razors; cases for razors; cases specially adapted for electric hair curling irons; electric and non-electric depilation appliances; electric hair clippers; electric hair crimper; electric hair cutters; electric hair styling irons; electric nasal hair trimmers; electric shavers; flat irons; hair crimping irons; non-electric depilatory appliances; non-electric razors; non-electric shavers; razors and razor blades; safety razors; shaving blades; shears; straight razors

**Application Number** 2,129,609  
**Language of Application** English

**Filing Date** 2021-08-26

## APPLICANT AND AGENT DETAILS

### Applicant

Shenzhen Maidejia Technology Co., Ltd.  
Room 816, Lankun Bldg., No.213, Minkang  
Rd., Minzhi St.  
Longhua Dist.  
Shenzhen, 518000  
CHINA

### Agent

XIN XU  
(Fang An Law PC), Suite 300 & 306, 5500  
North Service Rd., Burlington, ONTARIO,  
L7L6W6

## TRADEMARK DETAILS

# madeking

### Trademark Type

Standard Characters

### Goods

#### Class 21

animal activated livestock feeders; animal activated livestock waterers; brushes for pets; drinking troughs for animals; lawn sprinklers; non-mechanized pet waterers in the nature of portable water and fluid dispensers for pets; nozzles for sprinkler hose; nozzles for watering cans; nozzles for watering hose; pet bowls; pet feeding dishes; reusable plastic water bottles sold empty; sprinklers for watering flowers and plants; syringes for watering flowers and plants; water bottles

**Application Number** 2,129,610  
**Language of Application** English

**Filing Date** 2021-08-26

## APPLICANT AND AGENT DETAILS

### Applicant

Guangzhou Bosi International Trading Co., Ltd.  
Room 408, A101, No.890, Fuyu West Road,  
Chenyong Village, Qiaonan Street  
Panyu District  
Guangzhou, 510000  
CHINA

### Agent

YURI CHUMAK  
c/o Dickinson Wright LLP, 199 Bay Street,  
Suite 2200, Toronto, ONTARIO, M5L1G4

## TRADEMARK DETAILS

# Pearoot

### Trademark Type

Standard Characters

### Goods

#### Class 03

age spot reducing creams; anti-wrinkle creams; antiperspirants; aromatic essential oils; bath soap; beauty masks; cleansing milk for toilet purposes; cosmetic preparations for slimming purposes; cosmetics; cosmetics for animals; cosmetics for children; dry cleaning preparations; lipsticks; nail polish; non-medicated bubble bath preparations; perfumes; polishing creams; shampoos for pets; skin whitening creams; sunscreen preparations



**Application Number** 2,129,611  
**Language of Application** English

**Filing Date** 2021-08-26

## APPLICANT DETAILS

### Applicant

Nuviqo Ltd.  
2611-3985 Grand Park Dr  
Mississauga,  
ONTARIO  
L5B0H8

## TRADEMARK DETAILS

# Nuviqo

### Trademark Type

Standard Characters

### Goods

#### Class 28

ankle weights; ankle weights for exercise; barbells; body protectors for sports use; boxing bags; boxing gloves; dumb-bells; dumb-bells for weight lifting; elbow pads for sports use; gym balls for yoga; hand wraps for sports use; jump ropes; kettlebells; knee guards for athletic use; leg weights for exercise; leg weights for sports training; medicine balls; skipping ropes; sport balls; sport gloves; swings; trampolines; treadmills; weightlifting belts; wrist guards for athletic use; wrist weights for exercise; yoga blocks; yoga straps; yoga swings

**Application Number** 2,129,613  
**Language of Application** English

**Filing Date** 2021-08-26

## **APPLICANT DETAILS**

### **Applicant**

Cagie Science and Technology (Hangzhou)  
Co., Ltd.  
Room 501-3, Building 7, Xixi Century Center,  
Xihu District, Hangzhou, Zhejiang,  
CHINA

## **TRADEMARK DETAILS**

### **Trademark Type**

Design

### **Visual Representation**

**CAOii**

**Goods****Class 16**

adhesive tapes for stationery or household purposes; birthday books; calendars; coloured pens; day planners; diaries; drawing pads; lesson plans; marker pens; note books; note cards; notepads; planners for stationery use; pocket memorandum books; ring binders; sketch pads; spiral notebooks; stationery personal organizers; telephone books; year planners

**Application Number** 2,129,614  
**Language of Application** English

**Filing Date** 2021-08-26

## APPLICANT DETAILS

### Applicant

Meditate & Celebrate Inc.  
70 City Stroll  
Irvine, CA 92620-3883  
UNITED STATES OF AMERICA

## TRADEMARK DETAILS

### Trademark Type

Design

### Visual Representation



### Colour Claim

Colour is claimed as a feature of the trademark. The word "SAMADHAAN" is in color yellow with the infinity symbol, curve and circle in the color yellow inside a black rectangular box

### Foreign Character Translation

The translation provided by the applicant of the word(s) SAMADHAAN is MOTHER IN LAW.

### Goods

#### Class 25

adult sweatpants; clothing for gymnastics; pajamas; pants; printed t-shirts; sleep masks; tank-tops; yoga pants

**Application Number** 2,129,615  
**Language of Application** English

**Filing Date** 2021-08-26

## APPLICANT AND AGENT DETAILS

### Applicant

EHS Technology INC  
1226 North King St. #188  
Wilmington, DE 19801  
UNITED STATES OF AMERICA

### Agent

AVENTUM IP LAW LLP  
Suite 104, Tower A, 555 Legget Drive, Ottawa,  
ONTARIO, K2K2X3

## TRADEMARK DETAILS

# OGHom

### Trademark Type

Standard Characters

### Goods

#### Class 11

air cleaning units; air filtering units for removing dust, smoke and allergens from the air; bread baking machines; electric kettles; fabric steamers; garment steamers; hair dryers; humidifiers

**Application Number** 2,129,625  
**Language of Application** English

**Filing Date** 2021-08-26

## APPLICANT AND AGENT DETAILS

### Applicant

BANDOAFD Inc.  
211, 80, Seongbok 1-ro, Suji-gu  
Yongin-si, Gyeonggi-do, 16806  
REPUBLIC OF KOREA

### Agent

ALLAN OZIEL  
(Oziel Law), 180 John St, ON, 605, Toronto,  
ONTARIO, M5T1X5

## TRADEMARK DETAILS

### Trademark Type

Design

### Visual Representation



### Foreign Character Translation

The translation provided by the applicant of the ITALIAN word(s) FRUTTI is FRUITS.

### Goods

#### Class 30

fruit teas; non-alcoholic tea-based beverages; tea

**Application Number** 2,129,630  
**Language of Application** English

**Filing Date** 2021-08-26

## APPLICANT AND AGENT DETAILS

### Applicant

Canadian Imperial Bank of Commerce  
199 Bay Street, 11th Floor  
Toronto  
ONTARIO  
M5L1A2

### Agent

GOWLING WLG (CANADA) LLP  
SUITE 1600, 1 FIRST CANADIAN PLACE, 100  
KING STREET WEST, TORONTO, ONTARIO,  
M5X1G5

## TRADEMARK DETAILS

# Smart Start

### Trademark Type

Standard Characters

### Services

#### Class 36

banking services; debit card services

**Application Number** 2,129,631  
**Language of Application** English

**Filing Date** 2021-08-26

## APPLICANT AND AGENT DETAILS

### Applicant

Canadian Imperial Bank of Commerce  
199 Bay Street, 11th Floor  
Toronto  
ONTARIO  
M5L1A2

### Agent

GOWLING WLG (CANADA) LLP  
SUITE 1600, 1 FIRST CANADIAN PLACE, 100  
KING STREET WEST, TORONTO, ONTARIO,  
M5X1G5

## TRADEMARK DETAILS

# Départ Intelli

### Trademark Type

Standard Characters

### Services

#### Class 36

banking services; debit card services



**Application Number** 2,129,635  
**Language of Application** English

**Filing Date** 2021-08-26

## APPLICANT DETAILS

### Applicant

Laila Aouinati  
7-19255 Aloha Dr  
Surrey  
BRITISH COLUMBIA  
V4N6T8

## TRADEMARK DETAILS

# BAD\_DNA

**Trademark Type**  
Standard Characters

### Goods

#### Class 25

bermuda shorts; blazers; blouses; blousons; bodices; body suits; bomber jackets; bomber vests; button down shirts; camisoles; casual clothing featuring pants, dresses and shorts; coats; leather jackets; skirts and dresses

**Application Number** 2,129,636  
**Language of Application** English

**Filing Date** 2021-08-26

## APPLICANT AND AGENT DETAILS

### Applicant

VIÑA SAN PEDRO TARAPACÁ S.A.  
Av. Vitacura N° 2670, Piso 16  
Las Condes, Santiago,  
CHILE

### Agent

NORTON ROSE FULBRIGHT CANADA LLP/S.  
E.N.C.R.L.,S.R.L.  
1, Place Ville Marie, Suite 2500, Montreal,  
QUEBEC, H3B1R1

## TRADEMARK DETAILS

# WINEMALS

### Trademark Type

Standard Characters

### Goods

Class 33

Wines

**Application Number** 2,129,647  
**Language of Application** English

**Filing Date** 2021-08-26

## APPLICANT AND AGENT DETAILS

### Applicant

Shenzhen Oulei Technology Co., Ltd  
2nd Floor, Building No.17, Wanfeng 98  
Industrial Park,  
Zhongxin RD Shajing Street, Baoan District,  
Shenzhen, 518000  
CHINA

### Agent

WITMART INC.  
34 King Street East, Suite 500, Toronto,  
ONTARIO, M5C2X8

## TRADEMARK DETAILS

# Apalus

### Trademark Type

Standard Characters

### Goods

#### Class 01

(1) absorbing carbons; activated carbon; carbon for filters; desiccants for absorbing moisture; granular absorbent mineral-based composition for absorbing spills from floors; granulated carbon for water treatment

#### Class 11

(2) air conditioners; air deodorizing apparatus; air diffusers; air purifiers for household purposes; bed warmers; dehumidifiers; electric laundry dryers for household purposes; evaporators for air conditioners; facial steamers; filters for air conditioning; hair dryers; heating radiators; humidifiers; ice machines; lamp bulbs; water filtering units for domestic use

#### Class 19

(3) non-metal door casings; non-metal door frames; non-metallic door and window screens; non-metallic minerals for building; non-metallic minerals for construction; nylon mesh insect screens; nylon window screens; plastic window frames

#### Class 21

(4) electric insect killer; fly swatters; fly traps; insect traps; mouse traps; plug-in diffusers for mosquito repellents

#### Class 24

(5) bed blankets; curtains; curtains of plastic; curtains of textile; indoor and outdoor curtains; mosquito nets; net curtains; window curtains

**Application Number** 2,129,749  
**Language of Application** English

**Filing Date** 2021-08-26

## APPLICANT AND AGENT DETAILS

### Applicant

PetSmart Home Office, Inc.  
19601 N. 27th Avenue  
Phoenix, AZ 85027  
UNITED STATES OF AMERICA

### Agent

BORDEN LADNER GERVAIS LLP  
ATTN: INTELLECTUAL PROPERTY  
DEPARTMENT, 1000 DE LA GAUCHETIERE  
STREET WEST, SUITE 900, MONTREAL,  
QUEBEC, H3B5H4

## TRADEMARK DETAILS

# THE NICE LIST

### Trademark Type

Standard Characters

### Goods

#### Class 31

edible pet treats; pet food

### Claims

Priority Filing Date: March 11, 2021, Country or Office: UNITED STATES OF AMERICA,  
Application No: 90574320 in association with the same kind of goods

**Application Number** 2,129,767  
**Language of Application** English

**Filing Date** 2021-08-26

## **APPLICANT DETAILS**

### **Applicant**

Adnan Abu-Sharif  
1551 Montgomery Highway  
Hoover, AL 35216  
UNITED STATES OF AMERICA

## **TRADEMARK DETAILS**

# **THE PURPLE ONION**

### **Trademark Type**

Standard Characters

### **Services**

#### **Class 43**

restaurant services

**Application Number** 2,129,782  
**Language of Application** English

**Filing Date** 2021-08-26

## APPLICANT DETAILS

### Applicant

Andrzej Wytyczak-Partyka  
Krakowska 88a  
Wroc aw, 50-427  
POLAND

## TRADEMARK DETAILS

# Flotiq

### Trademark Type

Standard Characters

### Goods

#### Class 09

computer software for assisting developers in creating program code for use in mobile internet applications and client interfaces; computer software for assisting developers in creating program code for use in multiple application programs; computer software for creating searchable databases; computer software for creating searchable databases of information and data; computer software for use in creating and designing web sites

**Application Number** 2,129,804  
**Language of Application** English

**Filing Date** 2021-08-26

## APPLICANT DETAILS

### Applicant

Shenzhen Maishun Technology Co., Ltd  
#602, Build B, Minle Industrial Park  
Minzhi Street, Longhua District  
Shenzhen, 518000  
CHINA

## TRADEMARK DETAILS

# Mydethun

### Trademark Type

Standard Characters

### Goods

#### Class 11

ceiling lights; chandeliers; chinese lanterns; diving lights; electric lamps; electric torches for lighting; fairy lights for festive decoration; globes for lamps; incandescent burners; incandescent light bulbs; lamp glasses; lamp mantles; lampshade holders; lampshades; led luminaires; light bulbs; lighting fixtures; lights, electric, for Christmas trees; luminaires; luminous house numbers; safety lamps for underground use; searchlights; sockets for electric lights; spotlights; stage spotlights; street lamps

**Application Number** 2,129,808  
**Language of Application** English

**Filing Date** 2021-08-26

## APPLICANT DETAILS

### Applicant

Foshan Qisheng Sponge Co., Ltd.  
No. 20, West 3rd Road, Guanghua Bai'an  
Industrial Zone  
Xingtan Town, Shunde District  
Foshan City, Guangdong Province, 528000  
CHINA

## TRADEMARK DETAILS

# Slecofom

### Trademark Type

Standard Characters

### Goods

#### Class 20

bathroom furniture; bedroom furniture; beds for household pets; camping furniture; computer furniture; cushions; dining room furniture; dog kennels; fodder racks; garden furniture; inflatable furniture; kennels for household pets; kitchen furniture; lawn furniture; living room furniture; mattresses; nesting boxes; nesting boxes for household pets; office furniture; outdoor furniture; pet cushions; pet furniture; school furniture



**Application Number** 2,129,810  
**Language of Application** English

**Filing Date** 2021-08-26

## APPLICANT DETAILS

### Applicant

Foshan Qisheng Sponge Co., Ltd.  
No. 20, West 3rd Road, Guanghua Bai'an  
Industrial Zone  
Xingtan Town, Shunde District  
Foshan City, Guangdong Province, 528000  
CHINA

## TRADEMARK DETAILS

# Geegoos

### Trademark Type

Standard Characters

### Goods

#### Class 20

bathroom furniture; bedroom furniture; beds for household pets; camping furniture; computer furniture; cushions; dining room furniture; dog kennels; fodder racks; garden furniture; inflatable furniture; kennels for household pets; kitchen furniture; lawn furniture; living room furniture; mattresses; nesting boxes; nesting boxes for household pets; office furniture; outdoor furniture; pet cushions; pet furniture; school furniture

**Application Number** 2,129,814  
**Language of Application** English

**Filing Date** 2021-08-26

## **APPLICANT DETAILS**

**Applicant**  
TONGYING WEI  
No.1, Chongde Rd., Longgang Dist.  
Shenzhen, Guangdong, 518000  
CHINA

## **TRADEMARK DETAILS**

# **HYMGHO**

**Trademark Type**  
Standard Characters

**Goods**

**Class 28**

board games; checker boards; checker game sets; chess sets; chessboards; collectable toy figures; dice; dice cups; dice games; game cards; go games; ordinary playing cards

**Application Number** 2,129,818  
**Language of Application** English

**Filing Date** 2021-08-27

## APPLICANT DETAILS

**Applicant**  
TOGOSPICE INVESTMENTS LTD.  
PO Box 95086 Kingsgate  
Vancouver  
BRITISH COLUMBIA  
V5T4T8

## TRADEMARK DETAILS

# Togospice

**Trademark Type**  
Standard Characters

### Services

#### Class 37

(1) building construction contracting services; building construction services; building construction supervision; building demolition; building of shops; building restoration; construction and renovation of buildings; construction and repair of buildings; construction of buildings; construction project management services; real estate development

#### Class 43

(2) bar and restaurant services; business catering services; cafe-restaurants; cafés; carry-out restaurant services; carry-out restaurants; catering services for company cafeterias; catering services for conference centres; catering services for educational establishments; catering services for hospitality suites; catering services for hospitals; catering services for hotels; catering services for nursing homes; catering services for providing European-style cuisine; catering services for providing Japanese cuisine; catering services for providing Spanish cuisine; catering services for retirement homes; catering services for schools

**Application Number** 2,129,819  
**Language of Application** English

**Filing Date** 2021-08-27

## APPLICANT DETAILS

### Applicant

Xin Ma  
No.30, Wangying, Yugang Vlg, Yingzhuang  
Town, Wolong Dist  
Nanyang, Henan, 473136  
CHINA

## TRADEMARK DETAILS

# YWAJJ

### Trademark Type

Standard Characters

### Goods

#### Class 21

bottle openers; brushes for cleaning tanks and containers; cleaning cloth; cookery moulds; cookie cutters; cooking utensils; cosmetic brushes; drinking cups; food and beverage containers for household use; ice cube moulds; indoor terrariums for plants; make-up brushes; polishing cloths; soap dispensers; toilet brushes

**Application Number** 2,129,920  
**Language of Application** English

**Filing Date** 2021-08-27

## APPLICANT AND AGENT DETAILS

### Applicant

PetSmart Home Office, Inc.  
19601 N. 27th Avenue  
Phoenix, AZ 85027  
UNITED STATES OF AMERICA

### Agent

BORDEN LADNER GERVAIS LLP  
ATTN: INTELLECTUAL PROPERTY  
DEPARTMENT, 1000 DE LA GAUCHETIERE  
STREET WEST, SUITE 900, MONTREAL,  
QUEBEC, H3B5H4

## TRADEMARK DETAILS

# TREEMENDOUS

### Trademark Type

Standard Characters

### Goods

#### Class 31

edible pet treats; pet food

### Claims

Priority Filing Date: March 11, 2021, Country or Office: UNITED STATES OF AMERICA,  
Application No: 90574231 in association with the same kind of goods

**Application Number** 2,129,921  
**Language of Application** French

**Filing Date** 2021-08-27

## APPLICANT DETAILS

### Applicant

Les Investissements Out of the Box  
73 Rue Du Chinook  
Gatineau  
QUÉBEC  
J9A0A8

## TRADEMARK DETAILS

### Trademark Type

Design

### Visual Representation



### Colour Claim

Colour is claimed as a feature of the trademark. The logo consists of four hexagons of varying sizes, one being black and three being yellow. The "Free" portion of the name "Freebees" appears in black, and "bees" appears in yellow.

### Goods

#### Class 09

(1) Electronic gift cards; encoded gift cards; magnetically encoded gift cards.

#### Class 16

(2) Gift cards; membership cards.

### Services

#### Class 35

(1) Operation of a customer incentive, rewards and loyalty program; administration of consumer loyalty programs; administration of customer loyalty programs; administration of loyalty rewards programs featuring rewards points; development of marketing strategies and concepts for others; direct marketing of the goods and services of others; provision of a customer loyalty rewards program; promotion of the sale of goods and services through a consumer loyalty program; marketing analysis services.

**Class 42**

(2) Computer software system design; design and development of computer software; computer software design and development; design, development and implementation of software.

**Application Number** 2,129,932  
**Language of Application** English

**Filing Date** 2021-08-27

## APPLICANT DETAILS

### Applicant

Wenzhou Gforce optical Co.,Ltd  
ROOM F501,5TH FLOOR,NO.1650 LUCHENG  
ROAD  
LUCHENG DISTRICT  
WENZHOU CITY,ZHEJIANG PROVINCE,  
325000  
CHINA

## TRADEMARK DETAILS

### Trademark Type

Design

### Visual Representation

*JFXQL*

### Goods

#### Class 09

3D spectacles; anti-glare glasses; contact lenses; containers for contact lenses; correcting lenses; eyeglass cases; eyeglass chains; eyeglass cords; eyeglass frames; eyeglass lenses; eyeglasses; goggles for sports; magnifying glasses; smartglasses; sunglasses



**Application Number** 2,129,933  
**Language of Application** English

**Filing Date** 2021-08-27

## APPLICANT AND AGENT DETAILS

### Applicant

PetSmart Home Office, Inc.  
19601 N. 27th Avenue  
Phoenix, AZ 85027  
UNITED STATES OF AMERICA

### Agent

BORDEN LADNER GERVAIS LLP  
ATTN: INTELLECTUAL PROPERTY  
DEPARTMENT, 1000 DE LA GAUCHETIERE  
STREET WEST, SUITE 900, MONTREAL,  
QUEBEC, H3B5H4

## TRADEMARK DETAILS

# SNOWBALL BITES

### Trademark Type

Standard Characters

### Goods

#### Class 31

edible pet treats; pet food

### Claims

Priority Filing Date: March 11, 2021, Country or Office: UNITED STATES OF AMERICA,  
Application No: 90574254 in association with the same kind of goods

**Application Number** 2,129,948  
**Language of Application** English

**Filing Date** 2021-08-27

## APPLICANT AND AGENT DETAILS

### Applicant

Beiersdorf AG  
Unnastrasse 48  
Hamburg, 20253  
GERMANY

### Agent

GOWLING WLG (CANADA) LLP  
SUITE 1600, 1 FIRST CANADIAN PLACE, 100  
KING STREET WEST, TORONTO, ONTARIO,  
M5X1G5

## TRADEMARK DETAILS

# NIVEA ESSENTIAL

### Trademark Type

Standard Characters

### Goods

#### Class 03

lip care preparations

**Application Number** 2,129,959  
**Language of Application** English

**Filing Date** 2021-08-27

## APPLICANT AND AGENT DETAILS

### Applicant

Jennifer Bain  
1400-606 Spadina Cres E  
Saskatoon  
SASKATCHEWAN  
S7K3H1

### Agent

KURSTY L. BANSLEY  
(Ex Bar Trademark Agency Limited), PO Box  
62, Moose Jaw Main, Moose Jaw,  
SASKATCHEWAN, S6H4N7

## TRADEMARK DETAILS

# SEED TO SHADE WEALTH

### Trademark Type

Standard Characters

### Services

#### Class 36

advisory services relating to financial planning; consulting and information concerning insurance; estate planning services; financial advisory services, namely financial planning and investment management services; financial analysis consultation services; financial investment advisory services; financial investment counselling; financial planning and investment advisory services; financial planning for retirement; financial planning services; insurance information and consultancy; investment advisory and investment management services; providing information in insurance matters; providing insurance information and consultancy; providing stock market investment information and research in the field of financial planning and financial investments; retirement investment planning and advisory services

**Application Number** 2,129,977  
**Language of Application** English

**Filing Date** 2021-08-27

## **APPLICANT DETAILS**

### **Applicant**

Ravi Inder Khunkhun  
2329 Queen St  
Abbotsford  
BRITISH COLUMBIA  
V2T6J6

## **TRADEMARK DETAILS**

# **Coastal Valley**

### **Trademark Type**

Standard Characters

### **Services**

#### **Class 35**

(1) construction cost management

#### **Class 36**

(2) real estate consultation

#### **Class 37**

(3) building construction services

#### **Class 38**

(4) rental of video conferencing equipment

#### **Class 39**

(5) garbage collection services

#### **Class 40**

(6) blueprinting services

#### **Class 41**

(7) aerial photography

#### **Class 42**

(8) construction planning

#### **Class 43**

(9) rental of water dispensers

#### **Class 44**

(10) consultancy relating to landscape design

#### **Class 45**

(11) reviewing standards and practices to assure compliance with zoning regulations

**Application Number** 2,129,992  
**Language of Application** English

**Filing Date** 2021-08-27

## **APPLICANT DETAILS**

### **Applicant**

DNAME CORP.  
9131 Keele Street  
Unit A2  
Concord  
ONTARIO  
L4K0G7

## **TRADEMARK DETAILS**

# **DNA Allure**

### **Trademark Type**

Standard Characters

### **Services**

#### **Class 42**

(1) genetic testing for scientific research purposes

#### **Class 44**

(2) genetic testing for medical purposes

**Application Number** 2,130,004  
**Language of Application** English

**Filing Date** 2021-08-27

## APPLICANT AND AGENT DETAILS

**Applicant**

AIJO MART INC.  
12 Villanova Rd  
Brampton  
ONTARIO  
L6Y2Z4

**Agent**

PALMER IP INC.  
704 - 1478 Hastings St. West, Vancouver,  
BRITISH COLUMBIA, V6G3J6

## TRADEMARK DETAILS

**AIJO**

**Trademark Type**

Standard Characters

**Goods**

**Class 06**

shelf brackets of metal

**Application Number** 2,130,009  
**Language of Application** English

**Filing Date** 2021-08-27

## **APPLICANT DETAILS**

### **Applicant**

Miguel Dykstra  
34924 Edgeview place  
V2S 7R8  
Abbotsford  
BRITISH COLUMBIA  
V2S7R8

## **TRADEMARK DETAILS**

# **GYM RAT FITNESS**

### **Trademark Type**

Standard Characters

### **Goods**

#### **Class 25**

athletic shirts; graphic t-shirts; gym wear; long-sleeved shirts; muscle shirts

### **Services**

#### **Class 41**

providing fitness and exercise facilities; providing information in the field of exercise via an interactive website

**Application Number** 2,130,015  
**Language of Application** English

**Filing Date** 2021-08-27

## APPLICANT DETAILS

### Applicant

SHENZHEN P&S BUSINESS CO., LTD.  
308, 1970 TECH PARK  
MINZHI COMMUNITY, MINZHI ST.,  
LONGHUA DIST.  
SHENZHEN, 518000  
CHINA

## TRADEMARK DETAILS

# Pebrt

### Trademark Type

Standard Characters

### Goods

#### Class 21

bamboo place mats; beverage glassware; bowls; brooms; brushes for cleaning tanks and containers; coffee scoops; comb cases; cookery molds; cookery moulds; cooking funnels; cooking utensils; cork place mats; cosmetic brushes; cosmetic spatulas; cups; dinnerware; dishes; dishes and plates; dispensers for liquid soap for household purposes; drinking flasks; drinking glasses; drinking straws; egg separators; flower pots; food and beverage containers for household use; food storage containers; glass bottles; gloves for household purposes; hand-operated coffee grinders and pepper mills; ice cream scoops; ice cube molds; isothermic bags; jugs; lemon squeezers; make-up brushes; manual egg beaters; manual meat grinder; mixing spoons; non-electric griddles; non-electrical coffee grinders; oven mitts; pepper mills; pitchers; plastic bottles; salad bowls; salt cellars; sprinklers for watering flowers and plants; table plates; vacuum bottles; vacuum flasks; vases; waste receptacles

### Services

#### Class 35

advertising agency services; advertising by transmission of on-line publicity for third parties through electronic communications networks; advertising flyer distribution for others; advertising on the Internet for others; advertising services provided via the internet, namely, promoting the goods of others by providing information regarding discounts and special offers for the goods of others; advertising text publication services for others; advertising the goods and services of others in periodicals, brochures and newspapers; advertising the goods and services of others through all public communication means; advice and information about customer services and product management and prices on Internet sites in connection with purchases made over the Internet; auctioneering; billing services; business administration consultancy; business administration consulting services; business management assistance; consulting in the fields of business organization and management; creating and updating advertising material for others; direct mail advertising of the goods and services of others; direct marketing of the goods and services of others; dissemination of advertising for others via the Internet; dissemination of advertising matter



for others; distribution of advertising materials for others; import and export agencies; layout services for advertising purposes; market analysis; market research services; marketing analysis services; marketing services in the field of evaluating markets for existing goods and services of others; on-line advertising for others on computer networks; organization of exhibitions of flowers and plants for commercial or advertising purposes; organization of fashion shows for promotional purposes; personnel management consultancy; procurement of contracts for the purchase and sale of goods and services; product demonstration services in shop windows by live models; production of advertising films for others; promoting the goods and services of others by arranging for sponsors to affiliate their goods and services with live concert events; promoting the goods and services of others through advertisements on Internet websites; promoting the goods and services of others through infomercials; providing a searchable online advertising guide featuring the goods and services of other on-line vendors on the internet; providing and rental of advertising space on the internet; providing home shopping services of home entertainment electronics by means of television; provision of an on-line marketplace for buyers and sellers of goods and services; publication of publicity texts; publicity agency services; publicity agents; publicity bureau services; retail furniture store services; sales promotion for others by means of privileged user cards; telemarketing services; television advertising for others; updating and maintenance of data in computer databases

**Application Number** 2,132,407  
**International Registration Number** 1095467  
**Language of Application** English

**Filing Date** 2021-08-12

## APPLICANT AND AGENT DETAILS

### Applicant

EagleBurgmann Germany GmbH & Co. KG  
Äußere Sauerlacher Str. 6-10  
82515 Wolfratshausen  
GERMANY

### Agent

NORTON ROSE FULBRIGHT CANADA LLP/S.  
E.N.C.R.L.,S.R.L.  
1800 - 510 West Georgia Street, Vancouver,  
BRITISH COLUMBIA, V6B0M3

## TRADEMARK DETAILS

# APITEX

### Trademark Type

Standard Characters

### Goods

#### Class 07

(1) Shaft seals, in particular single-acting and double-acting floating ring seals with gas or liquid lubrication, for sealing liquid or gaseous media, including box-type floating ring seals, floating ring seals with sealing fluid water seals, floating ring seals with rinse functions, floating ring seals with leak recovery mechanisms, floating ring seals with leak checking mechanisms, all the aforesaid goods being machine parts; mechanical apparatus and equipment for storing, pressurizing, circulating and/or temperature control of fluids for use in mechanical seals, namely, closed loop fluid circuits, cyclone separators, agitators for circulating liquid media and leak collection containers

#### Class 09

(2) Temperature sensors; electrical leak detection hardware with embedded operating system software

**Application Number** 2,133,040  
**Language of Application** English

**Filing Date** 2021-09-13

## APPLICANT DETAILS

### Applicant

Timea Forisek  
4328  
Fisk Ave  
Prince George  
BRITISH COLUMBIA  
V2M5W7

## TRADEMARK DETAILS

# Simple Existence Products

### Trademark Type

Standard Characters

### Goods

#### Class 18

animal harnesses; animal identification collars; animal leads; animal leashes; animal muzzles; back packs; backpacks; backpacks, book bags, sports bags, bum bags, wallets and handbags; casual bags; cat collars; clothing for dogs; clothing for pets; collars for animals; collars for cats; collars for dogs; collars for pets; crossbody bags; dog apparel; dog clothing; dog leads; dog leashes; feed bags; leads for animals; leads for dogs; leads for pets; leashes for animals; leashes for dogs; leashes for pets; pet clothing; pet collars; pet collars bearing medical information; pet leads; pet leashes

**Application Number** 2,133,351  
**Language of Application** English

**Filing Date** 2021-09-15

## APPLICANT AND AGENT DETAILS

### Applicant

Unilever Canada Inc.  
160 Bloor Street East  
Suite 1400  
Toronto  
ONTARIO  
M4W3R2

### Agent

BAKER & MCKENZIE LLP  
BROOKFIELD PLACE, 181 BAY STREET,  
SUITE 2100, P.O. BOX 874, TORONTO,  
ONTARIO, M5J2T3

## TRADEMARK DETAILS

**Trademark Type**  
Design

### Visual Representation



### Goods

#### Class 30

Ice cream, water ice and frozen confections

**Application Number** 2,133,580  
**International Registration Number** 1613807  
**Language of Application** English

**Filing Date** 2020-12-29

## APPLICANT AND AGENT DETAILS

### Applicant

TAM PLASTIK VE KALIP SANAYI TICARET  
LIMITED SIRKETI  
Kavakli Mah. Deniz Aktas  
Caddesi No:32/1  
Beylikdüzü  
Istanbul  
TURKEY

### Agent

ANITA MAR  
dba Trademark Angel, Suite 521, 6-2557  
Dougall Avenue, Windsor, ONTARIO, N8X1T5

## TRADEMARK DETAILS

### Trademark Type

Design

### Visual Representation



### Colour Claim

Colour is claimed as a feature of the trademark. The colors white and blue are claimed as a feature of the trademark. In particular, the trademark consists of the wording TAM HANGERS and a hanger design in blue over a white background.

### Goods

#### Class 20

(1) Coat hangers made of metal and non-metal materials; plastic garment hangers; garment hangers; trouser hangers; skirt hangers; suit hangers; socks hangers; tie hangers; lingerie hangers; combination hangers for top and bottom clothing; garment hangers with clips; garment hangers with bar; garment hangers with spring mechanism; footwear hangers; towel hangers; scarf hangers; belt hangers; mannequin hangers (in the form of a frame, used to shape products); box hooks not of metal and bag hangers; box hooks not of metal and bag hooks of plastic for clothes packs; plastic hanger hooks, namely, hangers in the nature of non-metal hooks used to hang a purse or bag from a table, curtain hooks of plastic, plastic clothes hooks, plastic coat hooks, plastic hat hooks; parts used for garment hangers; hanger clips (used for fixing products on

hangers), namely, clips of plastic for hanging toys, non-metal clips for fastening pairs of socks for laundering; shirt and trouser hanger clips made of plastic for fixing and storage of clothes; size markers (item used to mark the size of the garment to be hung on a hanger), being part of clothes hangers; garment hanger lock; garment hanger security seals; plastic cords for fixing garments being parts of clothes hangers; connection parts for clothes hangers; hanger connectors being parts of clothes hangers; plastic panels in the nature of labels mounted on hangers to show the brand of garment products; plastic labels glued to the front of the garment hangers; plastic shaped plastic bars attached to garment hangers to protect clothes and pieces of clothing; shaped rubberized non-slip attachments for garment hangers; shaped non-slip pads with rubber for hangers, namely, anti-slip gripper pads for hangers; shaped rubber pads attached to the clips of the hanger to protect clothes; coat hanger (stand, fixable) and garment covers [storage]; garment hangers

**Class 21**

(2) Ironing boards and ironing board covers, shaped; drying racks for laundry

**Claims**

Priority Filing Date: July 01, 2020, Country or Office: TURKEY, Application No: 2020/72750 in association with the same kind of goods

**Application Number** 2,133,648  
**International Registration Number** 1613821  
**Language of Application** English

**Filing Date** 2021-04-07

## APPLICANT AND AGENT DETAILS

### Applicant

Heyday Wellness LLC  
166 Bowery, #2F  
New York NY 10012  
UNITED STATES OF AMERICA

### Agent

GOWLING WLG (CANADA) LLP  
TD Canada Trust Tower, Suite 1600, 421 -7  
Avenue SW, Calgary, ALBERTA, T2P4K9

## TRADEMARK DETAILS

# HEYDAY

### Trademark Type

Standard Characters

### Goods

#### Class 03

(1) Cosmetics; non-medicated skin care preparations; sunscreen; lip balm.

#### Class 21

(2) Cosmetic brushes being facial and body brushes;

### Services

#### Class 44

Skin care salons.

### Claims

Priority Filing Date: October 07, 2020, Country or Office: UNITED STATES OF AMERICA,  
Application No: 90239384 in association with the same kind of goods

**Application Number** 2,133,670  
**International Registration Number** 1613838  
**Language of Application** English

**Filing Date** 2021-04-22

## APPLICANT AND AGENT DETAILS

**Applicant**  
LOCATELLI S.P.A.  
VIA DELLA RESISTENZA 5/A  
ALMENNO SAN BARTOLOMEO (BG)  
ITALY

**Agent**  
ROBIC  
630, boul. René-Lévesque Ouest, 20e étage,  
Montréal, QUEBEC, H3B1S6

## TRADEMARK DETAILS

**Trademark Type**  
Design

**Visual Representation**





### Trademark Description

The trademark consists of an imprint depicting a highly stylized letter A, structured in two oblique bands, the left-hand one being greater in length and extending upward toward the right and slightly indented in the lower part, the right-hand one being shorter in length and extending upward toward the left, ending above in a sharpened part.

### Goods

#### Class 09

(1) Helmets for motorcyclists; bicycle helmets; protective helmets for sports; protective and safety helmets; face masks for protective helmets; face shields for protective helmets; goggles for motorcyclists; protective eyeglasses; side shields for eyeglasses; articles of protective clothing for wear by motorcyclists for protection against accident or injury; clothing for protection against accidents; shoes for protection against accidents, irradiation and fire; insulated clothing for protection against accidents or injury; protection devices for personal use against accidents, namely face-shields for protection against accidents, nets for protection against accidents; gloves for protection against accidents; clothing, footwear and headwear for protection against accidents, irradiation and fire.

#### Class 25

(2) Jackets for motorcyclists; gloves for motorcyclists; waterproof suits for motorcyclists; boots for motorcyclists; clothing, not being protective clothing, incorporating reflective and fluorescent elements, namely athletic clothing, casual clothing, everyday clothing, outdoor winter clothing; clothing for sports; clothing of leather or imitations of leather, namely leather belts, leather coats, leather dresses, leather gloves, leather pants, leather shirts, leather suits, leather trousers, leather vests, belts made from imitation leather, coats made from imitation leather, dresses made from imitation leather, gloves made from imitation leather, pants made from imitation leather, shirts made from imitation leather, suits made from imitation leather, trousers made from imitation leather, vests made from imitation leather; jackets [clothing]; leather jackets; rain jackets; wind jackets; padded jackets; waterproof jackets; light-reflecting jackets; sports jackets; wind-resistant jackets; rain pants; sweatpants; leather trousers; waterproof jackets and pants; moisture-wicking sports pants; padded pants for athletic use; boots; bandanas [neckerchiefs]; neck tube scarves; gloves [clothing].

### Claims

Priority Filing Date: October 29, 2020, Country or Office: ITALY, Application No: 302020000093628 in association with the same kind of goods

**Application Number** 2,133,671  
**International Registration Number** 1613372  
**Language of Application** English

**Filing Date** 2021-04-23

## APPLICANT DETAILS

### Applicant

Bayerische Motoren Werke Aktiengesellschaft  
Petuelring 130  
80809 München  
GERMANY

## TRADEMARK DETAILS

# M60

### Trademark Type

Standard Characters

### Goods

#### Class 12

Land vehicles namely, automobiles, passenger cars and sports utility vehicles; parts and accessories for land vehicles, namely structural parts for land vehicles, hoods, bodies, chassis, roofs, roof liners, doors, door sills, motors, engines, electric motors, motor grills, side grills being vehicle trim, transmissions, transmission shafts, transmission chains, driving chains, torsion bars, differentials, clutches, suspension springs, suspension systems, direction signals, horns, windshields, window, windscreen wipers, headlight wipers, fenders, drive belts, gears, gear boxes, reduction gears, axles, brakes and braking systems, brake discs, brake segments, brake blocks, brake pads, bumpers, spoilers, side skirts, front splitters, brake air ducts, vehicle seats, headrests for vehicle seats, fitted seat covers, caps for vehicle gas tanks, side mirrors, rear view mirrors, steering wheels, shock absorbers, safety belts, airbags, airbag covers, wheels, rims for vehicle wheels, hubcaps, hubs for vehicle wheels, inner tubes for pneumatic tires, tires for vehicles, valves for vehicle tires, valve stem caps for vehicle tires, anti-skid chains for tires, casings for pneumatic tires, mudguards, anti-theft devices, namely, anti-theft automotive alarms, reversing alarms for vehicles, car sun blinds, trailer hitches for automobiles, hydraulic circuits for vehicles, torque converters, anti-glare devices for automobiles being sun visors, roof rack storage containers for automobiles, ski carriers for use on automobiles, luggage carriers and nets for automobiles, safety seats for children, footrests for vehicles, roll bars for motor vehicles, connecting rods for land vehicles, other than parts of motors and engines; body kits comprised of external structural parts of automobiles

### Claims

Priority Filing Date: October 29, 2020, Country or Office: GERMANY, Application No: 30 2020 115 211 in association with the same kind of goods

**Application Number** 2,133,774  
**International Registration Number** 1612655  
**Language of Application** English

**Filing Date** 2021-06-09

## APPLICANT AND AGENT DETAILS

### Applicant

Marv Studios Limited  
11 Portland Mews  
London W1F 8JL  
UNITED KINGDOM

### Agent

FURMAN IP LAW & STRATEGY PC  
300 - 1914 HAMILTON STREET, REGINA,  
SASKATCHEWAN, S4P3N6

## TRADEMARK DETAILS

# STATESWOMAN

### Trademark Type

Standard Characters

### Goods

#### Class 09

(1) Computer games; interactive game programs and software; downloadable computer and electronic game programs; computer and electronic game software for use on mobile phones and wireless devices; downloadable software and computer programs in the nature of a mobile application for playing games; downloadable game related software applications; computer software for the administration of online games and mobile gaming; augmented reality software for playing computer and video games; artificial intelligence and machine learning software for use in the development, programming and play of video games and computer games and the programming of virtual and augmented reality environments; virtual reality software for playing computer and video games; computer hardware for games and gaming; virtual reality headsets and glasses; audio-visual headsets for playing video games; video games cartridges, discs and cassettes; CD-ROM encoded computer game software; downloadable information relating to games and gaming; downloadable electronic publications relating to games and gaming

#### Class 28

(2) Video game apparatus namely gaming consoles, controllers and accessories therefor; console gaming devices; portable gaming devices; action figures and accessories; board games, card games, playing cards; miniature toy vehicles, airplanes and helicopters; battery operated remote controlled toy vehicles; flying discs; jigsaw puzzles; kites; marbles; sit-in and ride-on toy vehicles; water squirting toys; toy pistols; target sets comprising toy guns, suction darts and target; pinball and arcade game machines and hand held units for playing electronic games; electronic games; arcade games

### Claims

Priority Filing Date: December 21, 2020, Country or Office: UNITED KINGDOM, Application No: UK00003570666 in association with the same kind of goods

**Application Number** 2,133,776  
**International Registration Number** 1612572  
**Language of Application** English

**Filing Date** 2021-06-09

## APPLICANT AND AGENT DETAILS

### Applicant

Marv Studios Limited  
11 Portland Mews  
London W1F 8JL  
UNITED KINGDOM

### Agent

FURMAN IP LAW & STRATEGY PC  
300 - 1914 HAMILTON STREET, REGINA,  
SASKATCHEWAN, S4P3N6

## TRADEMARK DETAILS

# STATESMAN

### Trademark Type

Standard Characters

### Goods

#### Class 09

(1) Computer games; interactive game programs and software; downloadable computer and electronic game programs; computer and electronic game software for use on mobile phones and wireless devices; downloadable software and computer programs in the nature of a mobile application for playing games; downloadable game related software applications; computer software for the administration of online games and mobile gaming; augmented reality software for playing computer and video games; artificial intelligence and machine learning software for use in the development, programming and play of video games and computer games and the programming of virtual and augmented reality environments; virtual reality software for playing computer and video games; computer hardware for games and gaming; virtual reality headsets and glasses; audio-visual headsets for playing video games; video games cartridges, discs and cassettes; CD-ROM encoded computer game software; downloadable information relating to games and gaming; downloadable electronic publications relating to games and gaming

#### Class 28

(2) Video game apparatus namely gaming consoles, controllers and accessories therefor; console gaming devices; portable gaming devices; action figures and accessories; board games, card games, playing cards; miniature toy vehicles, airplanes and helicopters; battery operated remote controlled toy vehicles; flying discs; jigsaw puzzles; kites; marbles; sit-in and ride-on toy vehicles; water squirting toys; toy pistols; target sets comprising toy guns, suction darts and target; pinball and arcade game machines and hand held units for playing electronic games; electronic games; arcade games

### Claims

Priority Filing Date: December 21, 2020, Country or Office: UNITED KINGDOM, Application No: UK00003570661 in association with the same kind of goods

**Application Number** 2,136,985  
**International Registration Number** 1615704  
**Language of Application** English

**Filing Date** 2021-08-08

## APPLICANT AND AGENT DETAILS

### Applicant

Beiersdorf AG  
Unnastr. 48  
20253 Hamburg  
GERMANY

### Agent

GOWLING WLG (CANADA) LLP  
SUITE 1600, 1 FIRST CANADIAN PLACE, 100  
KING STREET WEST, TORONTO, ONTARIO,  
M5X1G5

## TRADEMARK DETAILS

### Trademark Type

Design

### Visual Representation



### Colour Claim

Colour is claimed as a feature of the trademark. The colours medium blue, orange, light blue, dark blue and white are claimed as a feature of the trademark. The wording COPPERTONE is dark blue superimposed on a rectangle background in light blue. The wording COMPLETE is white superimposed on a rectangle background in medium blue. The girl and dog designs are medium blue superimposed on a semi-circle design background in orange.

### Goods

#### Class 03

Non-medicated cosmetics; non-medicated preparations for body and beauty care, namely sunscreen preparations; non-medicated sun care preparations for cosmetic and dermatological purposes, non-medicated after sun preparations for cosmetic and dermatological purposes.

**Claims**

Priority Filing Date: July 22, 2021, Country or Office: EUIPO (EU), Application No: 018519767 in association with the same kind of goods

**Application Number** 2,137,073  
**International Registration Number** 1528881  
**Language of Application** English

**Filing Date** 2021-09-09

## APPLICANT DETAILS

### Applicant

BIZTECH LAWYERS PTY LTD  
Level 2, 11-31 York Street  
Sydney NSW 2000  
AUSTRALIA

## TRADEMARK DETAILS

# Biztech Lawyers

### Trademark Type

Standard Characters

### Services

#### Class 45

Legal services; professional advisory services relating to the licensing of industrial property; legal services relating to the exploitation of patents; legal information research services; legal services relating to the exploitation of inventions; legal services relating to the exploitation of copyrights; legal information services; legal services relating to trade marks exploitation; consultancy relating to the protection of intellectual property; licensing of intellectual property; legal advice; advisory services relating to the enforcement of intellectual property rights; prosecution of applications for industrial property rights; industrial property (intellectual property) management; litigation services; certification of legal documents; copyright management; legal advocacy services; legal investigation services; legal support services; litigation advice; intellectual property licensing services; arbitration services; professional advisory services relating to infringement of patents; legal document preparation services; legal research; monitoring intellectual property rights for legal advisory purposes; legal research relating to intellectual property; legal mediation services; personal legal services; legal consultancy services; legal advisory services relating to trade marks; legal advice in responding to requests for proposals (rfps); legal services relating to the negotiation of contracts (for others); legal services in relation to the negotiation of contracts for others; provision of information relating to legal services; professional advisory services relating to licensing of patents; information services relating to legal matters; prosecution of applications for intellectual property rights; legal administration of licences; advisory services relating to the law; legal enquiry services; legal lobbying services; provision of legal services; providing information, including online, about legal services; licensing of computer software (legal services); provision of legal information; judicial advocacy services; licensing (legal services) in the framework of software publishing; professional legal consultations relating to franchising; provision of legal research; professional advisory services relating to infringement of industrial property.

**Application Number** 2,138,180  
**International Registration Number** 1616859  
**Language of Application** English

**Filing Date** 2021-06-20

## APPLICANT AND AGENT DETAILS

### Applicant

Radnor Hills Mineral Water Company Limited  
Heartsease,  
Knighton, Powys LD7 1LU  
UNITED KINGDOM

### Agent

MARKS & CLERK  
33 Yonge Street, , Suite 300, Toronto,  
ONTARIO, M5E1G4

## TRADEMARK DETAILS

# HEARTSEASE FARM

### Trademark Type

Standard Characters

### Goods

#### Class 32

Non-alcoholic beverages namely fruit flavored still and carbonated beverages, ginger beer, vitamin enhanced water, vitamin enriched fruit juice; soft drinks; fruit drinks; fruit juice beverages; beverages consisting of a blend of fruit and vegetable juices; bottled fruit drinks; fresh fruit juices; still and bottled water; carbonated water; spring water; drinking water; mineral water; flavoured waters; syrups and other preparations for making beverages, namely concentrates and powders used in the preparation of fruit-flavored beverages, concentrates used in the preparation of soft drinks, preparations for making mineral water, essences for making non-alcoholic drinks.



**Application Number** 2,138,280  
**International Registration Number** 1617593  
**Language of Application** English

**Filing Date** 2021-07-19

## APPLICANT AND AGENT DETAILS

### Applicant

Shanghai Foodchain4pet Bio-technologyCo.,  
LTD  
Building 4, 158 Shumin Road,  
Chedun Town, Songjiang District  
361012 Shanghai  
CHINA

### Agent

MBM INTELLECTUAL PROPERTY AGENCY  
275 SLATER STREET, 14TH FLOOR,  
OTTAWA, ONTARIO, K1P5H9

## TRADEMARK DETAILS

# Foodchain4Pet

### Trademark Type

Standard Characters

### Goods

#### Class 31

Edible chews for animals; animal foodstuffs, namely animal food pellets; yeast for animal consumption; stall food for animals, namely grains for animal consumption; pet food; beverages for pets; dog biscuits; sanded paper [litter] for pets, namely litter for animals; aromatic sand [litter] for pets, namely aromatic sand litter for pets

### Services

#### Class 35

Commercial administration of the licensing of the goods and services of others; provision of an online marketplace for buyers and sellers of goods and services; personnel management consultancy; wholesale services for pharmaceutical, veterinary and sanitary preparations and medical supplies

**Application Number** 2,138,427  
**International Registration Number** 1616569  
**Language of Application** English

**Filing Date** 2021-08-06

## APPLICANT AND AGENT DETAILS

### Applicant

GoBrands, Inc.  
537 N 3rd Street  
Philadelphia PA 19123  
UNITED STATES OF AMERICA

### Agent

DEETH WILLIAMS WALL LLP  
150 YORK STREET, SUITE 400, TORONTO,  
ONTARIO, M5H3S5

## TRADEMARK DETAILS

# BASICALLY

### Trademark Type

Standard Characters

### Goods

#### Class 09

Batteries, namely, general purpose batteries; battery chargers for mobile phones; protective covers and cases for mobile phones; mobile phone straps; stands adapted for mobile phones.

### Claims

Priority Filing Date: May 07, 2021, Country or Office: UNITED STATES OF AMERICA, Application No: 90697347 in association with the same kind of goods

**Application Number** 2,138,512  
**International Registration Number** 1618079  
**Language of Application** English

**Filing Date** 2021-08-11

## APPLICANT AND AGENT DETAILS

### Applicant

Beiersdorf AG  
Unnastr. 48  
20253 Hamburg  
GERMANY

### Agent

GOWLING WLG (CANADA) LLP  
SUITE 1600, 1 FIRST CANADIAN PLACE, 100  
KING STREET WEST, TORONTO, ONTARIO,  
M5X1G5

## TRADEMARK DETAILS

### Trademark Type

Design

### Visual Representation



  
**Colour Claim**

Colour is claimed as a feature of the trademark. The colours dark blue, light blue, and yellow are claimed as a feature of the trademark. The girl and dog designs are dark blue superimposed on a semi-circle design background in yellow. The semi-circle design is on a quadrilateral background in light blue with a rectangle in dark blue underneath.

**Goods****Class 03**

Non-medicated cosmetics; non-medicated preparations for body and beauty care, namely sunscreen preparations; non-medicated sun care preparations for cosmetic and dermatological purposes, non-medicated after sun preparations for cosmetic and dermatological purposes.

**Claims**

Priority Filing Date: July 22, 2021, Country or Office: EUIPO (EU), Application No: 018518948 in association with the same kind of goods

**Application Number** 2,138,526  
**International Registration Number** 1617534  
**Language of Application** English

**Filing Date** 2021-08-12

## APPLICANT AND AGENT DETAILS

### Applicant

AIM BEVERAGES LLC  
2424 N. Federal Highway, Suite 303  
Boca Raton FL 33431  
UNITED STATES OF AMERICA

### Agent

R.GRANT CANSFIELD  
(c/o AIRD & BERLIS LLP), BROOKFIELD  
PLACE, SUITE 1800, 181 BAY STREET,  
TORONTO, ONTARIO, M5J2T9

## TRADEMARK DETAILS

# DEEP HYDRATION

### Trademark Type

Standard Characters

### Disclaimer

The right to the exclusive use of the word HYDRATION is disclaimed apart from the trademark.

### Goods

#### Class 05

(1) Dietary supplements for skin and cellular health and hydration in the form of powders, tablets and liquid drops for consumption containing vitamins and liquid silica and other minerals

#### Class 32

(2) Mineral waters and aerated waters; isotonic drinks and hypotonic drinks

(3) Carbonated waters; flavored waters and non-alcoholic beverages, namely, fruit punches, smoothies and lemonades; hypertonic drinks; fruit juices and fruit drinks; vegetable juices and vegetable drinks; syrups for making beverages; non-alcoholic cocktails; non-alcoholic punches, non-alcoholic cocktail beverages; non-alcoholic fruit drinks, non-alcoholic liqueurs; soft drinks, namely, carbonated and non-carbonated soft drinks, energy drinks and coffee-flavored soft drinks; and non-alcoholic drinks, namely, energy shots

### Claims

Priority Filing Date: February 12, 2021, Country or Office: UNITED STATES OF AMERICA,  
Application No: 90526741 in association with the same kind of goods (2)

**Application Number** 2,138,614  
**International Registration Number** 1409221  
**Language of Application** English

**Filing Date** 2021-08-25

## APPLICANT AND AGENT DETAILS

### Applicant

Symrise AG  
Mühlenfeldstr. 1  
37603 Holzminden  
GERMANY

### Agent

SMART & BIGGAR LP  
SUITE 900, 55 METCALFE STREET, P.O.  
BOX 2999, STATION D, OTTAWA, ONTARIO,  
K1P5Y6

## TRADEMARK DETAILS

# SYMCONTROL

### Trademark Type

Standard Characters

### Goods

#### Class 01

(1) Chemical compositions and raw materials for cosmetics, in particular botanical and botanically derived extracts for use in the manufacture of cosmetics; active chemical ingredients used for manufacture of cosmetic; additives for use in the manufacture of cosmetics

#### Class 03

(2) Skin care cosmetics; hair cosmetics.

**Application Number** 2,138,616  
**International Registration Number** 1616629  
**Language of Application** English

**Filing Date** 2021-08-25

## APPLICANT AND AGENT DETAILS

### Applicant

Rothbury Wines Pty Ltd  
Level 8,  
161 Collins Street  
Melbourne VIC 3000  
AUSTRALIA

### Agent

GOWLING WLG (CANADA) LLP  
SUITE 2600, 160 ELGIN STREET, OTTAWA,  
ONTARIO, K1P1C3

## TRADEMARK DETAILS

# THIS IS HOW WE ROSÉ

### Trademark Type

Standard Characters

### Goods

#### Class 33

Wine; alcoholic beverages, except beers, namely, fortified wines, sparkling wines, alcoholic coolers, vodka, whisky, bourbon, tequila, calvados, scotch, rye whiskey, cognac, gin, rum, brandy, liqueurs

### Claims

Priority Filing Date: February 27, 2021, Country or Office: UNITED STATES OF AMERICA,  
Application No: 90550592 in association with the same kind of goods

**Application Number** 2,139,668  
**International Registration Number** 1619267  
**Language of Application** English

**Filing Date** 2021-03-29

## APPLICANT AND AGENT DETAILS

### Applicant

Marc Jacobs Trademarks, L.L.C.  
72 Spring Street  
New York NY 10012  
UNITED STATES OF AMERICA

### Agent

ROBIC  
630, boul. René-Lévesque Ouest, 20e étage,  
Montréal, QUEBEC, H3B1S6

## TRADEMARK DETAILS

### Trademark Type

Design

### Visual Representation



**heaven**  
**BY MARC JACOBS**

### Trademark Description

The mark consists of the stylized word "HEAVEN" with the phrase "BY MARC JACOBS" appearing beneath it in block letters.

### Authorisation For Use

Consent from MARC JACOBS is of record.

### Goods

#### Class 18

(1) Handbags; knapsacks; back packs; rucksacks; tote bags; beach bags; carry-all bags; satchels; clutch bags; shoulder bags; sling bags; purses; cosmetic bags sold empty; change purses; wallets; leather pouches; business card cases; credit card cases; toiletry cases sold empty; crossbody bags; traveling bags.

#### Class 20

(2) Pillows.

#### Class 24

(3) Blankets; towels.



**Class 25**

(4) Clothing, namely, underwear, socks, hosiery, jerseys, shirts, t-shirts, blouses, sweaters, cardigan sweaters, pullovers, hoodies, sweatshirts, pants, jeans, shorts, dresses, skirts, blazers, jackets, coats, overcoats, waterproof clothing, namely, jackets and jumpsuits; bathing suits; belts; scarves; shawls; bandanas; waistcoats; pajamas; footwear, namely, shoes, boots, sandals and slippers; headwear, namely, hats and caps.

**Class 27**

(5) Rugs.

**Claims**

Priority Filing Date: March 09, 2021, Country or Office: UNITED STATES OF AMERICA, Application No: 90568968 in association with the same kind of goods (3); March 09, 2021, Country or Office: UNITED STATES OF AMERICA, Application No: 90568609 in association with the same kind of goods (2), (5)

**Application Number** 2,140,252  
**International Registration Number** 1618920  
**Language of Application** French

**Filing Date** 2021-09-07

## APPLICANT AND AGENT DETAILS

**Applicant**  
L'OREAL  
14 rue Royale  
F-75008 Paris  
FRANCE

**Agent**  
FASKEN MARTINEAU DUMOULIN LLP  
Tour de la Bourse, Suite 3500, P.O. box 242,  
800, Place Victoria, Montréal, QUÉBEC,  
H4Z1E9

## TRADEMARK DETAILS

# ENCENS CELESTE

**Trademark Type**  
Standard Characters

### Goods

#### Class 03

Cosmetics; perfumes; eaux de toilette; eau de Cologne; personal deodorants; makeup; essential oils for personal use.

### Claims

Priority Filing Date: April 06, 2021, Country or Office: FRANCE, Application No: 4751984 in association with the same kind of goods

Application Number 2,141,247  
International Registration Number 1621364  
Language of Application English

Filing Date 2021-03-29

## APPLICANT AND AGENT DETAILS

### Applicant

Marc Jacobs Trademarks, L.L.C.  
72 Spring Street  
New York NY 10012  
UNITED STATES OF AMERICA

### Agent

ROBIC  
630, boul. René-Lévesque Ouest, 20e étage,  
Montréal, QUEBEC, H3B1S6

## TRADEMARK DETAILS

### Trademark Type

Design

### Visual Representation



**Trademark Description**

The mark consists of a stylized teddy bear design with two heads, which contains two eyes in each head, and has the stylized word HEAVEN appearing horizontally across the span of its arms. The stylized phrase "BY MARC JACOBS" appears beneath the stylized word "HEAVEN".

**Authorisation For Use**

Consent from MARC JACOBS is of record.

**Goods****Class 18**

(1) Handbags; knapsacks; back packs; rucksacks; tote bags; beach bags; carry-all bags; satchels; clutch bags; shoulder bags; sling bags; purses; cosmetic bags sold empty; change purses; wallets; leather pouches; business card cases; credit card cases; toiletry cases sold empty; crossbody bags; traveling bags.

**Class 20**

(3) Pillows.

**Class 24**

(5) Blankets; Towels.

**Class 25**

(2) Clothing, namely, underwear, socks, hosiery, jerseys, shirts, t-shirts, blouses, sweaters, cardigan sweaters, pullovers, hoodies, sweatshirts, pants, jeans, shorts, dresses, skirts, blazers, jackets, coats, overcoats, waterproof clothing, namely, jackets and jumpsuits; bathing suits; belts; scarves; shawls; bandanas; waistcoats; pajamas; footwear, namely, shoes, boots, sandals and slippers; headwear, namely, hats and caps.

**Class 27**

(4) Rugs.

**Claims**

Priority Filing Date: March 09, 2021, Country or Office: UNITED STATES OF AMERICA, Application No: 90568941 in association with the same kind of goods (5); March 09, 2021, Country or Office: UNITED STATES OF AMERICA, Application No: 90568651 in association with the same kind of goods (3), (4)

**Application Number** 2,141,257  
**Language of Application** English

**Filing Date** 2021-10-20

## APPLICANT AND AGENT DETAILS

### Applicant

Mark Anthony Group Inc.  
Unit 100 - 565 Great Northern Way  
Vancouver  
BRITISH COLUMBIA  
V5T0H8

### Agent

GOWLING WLG (CANADA) LLP  
550 BARRARD STREET, SUITE 2300,  
VANCOUVER, BRITISH COLUMBIA, V6C2B5

## TRADEMARK DETAILS

# TIERRA RICA

### Trademark Type

Standard Characters

### Foreign Character Translation

The translation provided by the applicant of the Spanish words TIERRA RICA is RICH LAND.

### Goods

#### Class 33

wines

**Application Number** 2,141,453  
**International Registration Number** 1621088A  
**Language of Application** English

**Filing Date** 2021-07-14

## APPLICANT AND AGENT DETAILS

### Applicant

Nintendo of America Inc.  
4600 150th Avenue NE  
Redmond WA 98052  
UNITED STATES OF AMERICA

### Agent

SMART & BIGGAR LP  
2300 - 1055 West Georgia Street, P.O. Box  
11115, Vancouver, BRITISH COLUMBIA,  
V6E3P3

## TRADEMARK DETAILS

# METROID

### Trademark Type

Standard Characters

### Goods

#### Class 09

(1) Recorded electronic game software; downloadable electronic game software; recorded video game software; downloadable video game software; video game cartridges; cases for smartphones; recorded computer game software; downloadable computer game software; downloadable image files containing artwork, game guides, audio clips, video clips relating to video games; downloadable music files; downloadable electronic publications, namely fiction stories, booklets, manuals and newsletters in the field of video games

#### Class 14

(2) Key rings; key chains; charms for key rings; jewelry boxes; coins; jewelry; necklaces; bracelets; jewelry charms; earrings; tie pins; rings being jewelry; medals; ornamental pins; shoe jewelry; watches; clocks; watch bands.

#### Class 16

(3) Office requisites, namely stationery binders and file folders; wrapping paper; paper bags and sacks; place mats of paper; coasters of paper; table napkins of paper; tablecloths of paper; paper; writing stationery; notebooks; pen cases; paint boxes; writing instruments; pens; pencils; pen cases; rubber erasers; pencil sharpeners; postcards; greeting cards; stickers; decals; printed matter, namely calendars, children's activities books, magazines and manuals in the field of video games; books in the field of children's entertainment, fiction stories, and video games; comic books; posters; pictures; photograph stands; paper party decorations.

#### Class 18

(4) Clothing for pets; collars for pets; bags, namely book bags, carry-on bags, shoulder bags, handbags, backpacks, drawstring pouches, travel bags, and luggage; school bags; rucksacks; suitcases; card cases; purses; wallets; key cases; luggage tags; garment bags for travel; bags for sports; unfitted vanity cases; umbrellas

#### Class 25

(5) Clothing, namely polo shirts, sweatshirts, parkas, jackets, raincoats, pants, dresses, sweatpants, skirts, and sweaters; shirts; tee-shirts; pajamas; underwear; bathing suits; socks; scarves; muffler scarves; ear muffs; gloves; bibs, not of paper, namely cloth bibs and babies' bibs of plastic; hats; caps; cap peaks; belts; footwear, namely, athletic footwear, casual footwear, children's footwear, exercise footwear, infant footwear, rain footwear; sports shoes; sandals; slippers; masquerade costumes; Halloween costumes.

### **Class 28**

(6) Games, namely card games, promotional game cards, puzzles, trading card games; toys, namely toy balls, toy key chains, toy figures, water toys, plush toys, inflatable toys, party favors in the nature of small toys, toy balloons, toy building blocks, toy vehicle; ride-on toys; ride-on toy cars; stuffed toys; dolls; portable games with liquid crystal displays; protective films adapted for screens for portable games; video game machines; controllers for game consoles; hand-held units for playing video games; arcade video game machines; board games; playing cards; ornaments for Christmas trees, except lights, candles and confectionery; protective carrying cases specially adapted for handheld video games.

### **Services**

#### **Class 41**

Entertainment services, namely providing non-downloadable images featuring images of characters and scenes from an electronic game via a global computer network and wireless networks; entertainment services, namely providing non-downloadable prerecorded music and sounds in the field of video games, all on-line via a global computer network; entertainment services, namely providing temporary use of non downloadable video games; providing entertainment information on video games and related video gaming products; providing non-downloadable online electronic publications namely, online journals and interactive online blogs featuring user generated or specified content in the field of video games and online publications of electronic books and magazines; providing non-downloadable online videos featuring video games via the Internet; providing non-downloadable music via the Internet; entertainment services in the nature of live theatrical performances; arranging and conducting musical concerts; arranging and conducting of video game events for entertainment purposes; rental of game machines; toy rental; providing online video gaming services; organization of electronic game competitions for entertainment purposes; providing amusement arcade services.

### **Claims**

Priority Filing Date: June 14, 2021, Country or Office: JAPAN, Application No: 2021-073428 in association with the same kind of goods (2), (3), (4), (5), (6) and in association with the same kind of services

**Application Number** 2,141,560  
**International Registration Number** 1620598A  
**Language of Application** English

**Filing Date** 2021-08-06

## APPLICANT AND AGENT DETAILS

### Applicant

Nintendo of America Inc.  
4600 150th Avenue NE  
Redmond WA 98052  
UNITED STATES OF AMERICA

### Agent

SMART & BIGGAR LP  
2300 - 1055 West Georgia Street, P.O. Box  
11115, Vancouver, BRITISH COLUMBIA,  
V6E3P3

## TRADEMARK DETAILS

# METROID DREAD

### Trademark Type

Standard Characters

### Goods

#### Class 09

Recorded electronic game software; downloadable electronic game software; recorded video game software; downloadable video game software; video game cartridges; memory cards for video game machines; cases for smartphones; covers for smartphones; recorded computer game software; downloadable computer game software; downloadable image files containing artwork, game guides, audio clips, video clips relating to video games; downloadable music files; downloadable electronic publications, namely fiction stories, booklets, manuals and newsletters in the field of video games; headphones; earphones

### Claims

Priority Filing Date: June 14, 2021, Country or Office: JAPAN, Application No: 2021-073429 in association with the same kind of goods



**Application Number** 2,141,609  
**International Registration Number** 1620079  
**Language of Application** English

**Filing Date** 2021-08-16

## APPLICANT AND AGENT DETAILS

### Applicant

Waterwood Australia Pty Ltd  
SE 450, Level 4, 33 Pirie Street  
ADELAIDE SA 5000  
AUSTRALIA

### Agent

BORDEN LADNER GERVAIS LLP  
World Exchange Plaza, 100 Queen Street,  
Suite 1300, Ottawa, ONTARIO, K1P1J9

## TRADEMARK DETAILS

### Trademark Type

Design

### Visual Representation



### Colour Claim

Colour is claimed as a feature of the trademark. The colour(s) black, white and orange is/are claimed as a feature of the mark. The mark consists of the stylized wording "REFURESH" in the center of black oval, where "RE" and "ESH" are in white and "FUR" is in orange.

### Goods

#### Class 03

(1) Non-medicated grooming preparations for pets; non-medicated pet shampoos.

#### Class 07

(2) Hair clipping machines for animals.

**Class 21**

(3) Pet grooming tools, being brushes for grooming pet animals; combs for grooming pet animals.

**Services**

**Class 44**

Pet salon services; advisory services relating to the care of pet animals; grooming of pet animals; pet grooming; beauty salon for pets; pet bathing services.

**Application Number** 2,142,514  
**Language of Application** English

**Filing Date** 2021-10-25

## **APPLICANT AND AGENT DETAILS**

### **Applicant**

The Procter & Gamble Company  
One Procter & Gamble Plaza  
Cincinnati, OH 45202  
UNITED STATES OF AMERICA

### **Agent**

WILSON LUE LLP  
250 University Avenue, 5th Floor, Toronto,  
ONTARIO, M5H3E5

## **TRADEMARK DETAILS**

# **SMART SLEEP COACH BY PAMPERS**

### **Trademark Type**

Standard Characters

### **Goods**

#### **Class 09**

downloadable mobile application that provides sleep training solutions and techniques for babies;

**Application Number** 2,142,541  
**Language of Application** English

**Filing Date** 2021-10-25

## APPLICANT AND AGENT DETAILS

**Applicant**  
MARC JACOBS TRADEMARKS, L.L.C.  
72 Spring Street - 2nd Floor  
New York, NY 10012  
UNITED STATES OF AMERICA

**Agent**  
ROBIC  
630, boul. René-Lévesque Ouest, 20e étage,  
Montréal, QUEBEC, H3B1S6

## TRADEMARK DETAILS

**Trademark Type**  
Design

### Visual Representation



### Colour Claim

Colour is claimed as a feature of the trademark. The reading matter is black; the hand is light pink and black; the star is yellow and black, the bottle is pink and black, the bow tie is grey and black, the dices are light pink and black, the background is light pink and the rectangle frame is gold.

### Authorisation For Use

Consent from MARC JACOBS is of record.

### Goods

#### Class 03

Cosmetics; make-up; fragrances for personal use; perfume; cologne.

**Application Number** 2,143,192  
**International Registration Number** 1623386  
**Language of Application** French

**Filing Date** 2021-06-25

## APPLICANT AND AGENT DETAILS

### Applicant

GENFIT  
885 avenue Eugène Avinée,  
Parc Eurasanté  
F-59120 LOOS  
FRANCE

### Agent

ROBIC  
630, boul. René-Lévesque Ouest, 20e étage,  
Montréal, QUÉBEC, H3B1S6

## TRADEMARK DETAILS

### Trademark Type

Design

### Visual Representation



### Colour Claim

Colour is claimed as a feature of the trademark. The mark appears in standard blue letters, with the exception of the letter V that is stylized and orange.

### Goods

#### Class 05

Pharmaceutical preparations for the prevention and treatment of liver diseases, namely non-alcoholic fatty liver disease, non-alcoholic steatohepatitis, non-alcoholic hepatic diseases, liver fibrosis, hepatitis, cirrhosis, liver cancer, primary biliary cirrhosis, primary biliary cholangitis (PBC), primary sclerosing cholangitis (PSC), intrahepatic cholangitis, cholestatic diseases, metabolic diseases, namely obesity, type 2 diabetes, strokes, cardiovascular diseases, gastroenterological diseases, inflammatory diseases that cause liver inflammation and hepatic fibrosis, autoimmune diseases and cancers; diagnostic products for medical use, namely diagnostic biomarker reagents for medical use; diagnostic tests for medical use, namely reagents, nucleotide sequences, enzymes, nucleotides for blood tests, in the form of test strips; medical diagnostic reagents.

### Services

#### Class 42

Scientific research for medical purposes relating to hepatic diseases, metabolic diseases, gastroenterological diseases, cardiovascular diseases, inflammatory diseases that cause liver inflammation and hepatic fibrosis, autoimmune diseases and cancers; research and development of new pharmaceutical products for others; conduct of clinical trials for pharmaceutical preparations, in particular conduct of clinical trials for determining the effectiveness and safety of a molecule; conduct of clinical trials for determining the effectiveness and safety of pharmaceuticals in the treatment of primary biliary cholangitis (PBC); conduct of scientific studies and analyses, namely biochemical and molecular analyses relating to hepatic diseases, metabolic diseases, gastroenterological diseases, cardiovascular diseases, inflammatory diseases that cause liver inflammation and hepatic fibrosis, autoimmune diseases and cancers; provision of information, results and data related to scientific or medical research and development of pharmaceutical preparations; clinical trials; effectiveness assessments of pharmaceutical preparations.

**Claims**

Priority Filing Date: December 29, 2020, Country or Office: FRANCE, Application No: 4716462 in association with the same kind of goods and in association with the same kind of services

**Application Number** 2,144,054  
**Language of Application** English

**Filing Date** 2021-10-29

## **APPLICANT AND AGENT DETAILS**

### **Applicant**

The Procter & Gamble Company  
One Procter & Gamble Plaza  
Cincinnati, OH 45202  
UNITED STATES OF AMERICA

### **Agent**

WILSON LUE LLP  
250 University Avenue, 5th Floor, Toronto,  
ONTARIO, M5H3E5

## **TRADEMARK DETAILS**

# **PAMPERS LOCKAWAY CHANNELS**

### **Trademark Type**

Standard Characters

### **Goods**

#### **Class 05**

disposable diapers; disposable training pants

**Application Number** 2,144,056  
**Language of Application** English

**Filing Date** 2021-10-29

## APPLICANT AND AGENT DETAILS

### Applicant

The Procter & Gamble Company  
One Procter & Gamble Plaza  
Cincinnati, OH 45202  
UNITED STATES OF AMERICA

### Agent

WILSON LUE LLP  
250 University Avenue, 5th Floor, Toronto,  
ONTARIO, M5H3E5

## TRADEMARK DETAILS

### Trademark Type

Design

### Visual Representation



### Goods

#### Class 05

disposable diapers; disposable training pants



**Application Number** 2,144,417  
**Language of Application** French

**Filing Date** 2021-11-02

## APPLICANT AND AGENT DETAILS

**Applicant**

9388-9764 Québec inc., f.a.s. Distillerie du Quai  
14825 boul. Bécancour  
Bécancour  
QUÉBEC  
G9H2L2

**Agent**

ROBIC  
630, boul. René-Lévesque Ouest, 20e étage,  
Montréal, QUÉBEC, H3B1S6

## TRADEMARK DETAILS

# SOPHIA

**Trademark Type**

Standard Characters

**Goods**

**Class 33**

Gin.

**Application Number** 2,144,823  
**International Registration Number** 1624473  
**Language of Application** English

**Filing Date** 2021-04-28

## APPLICANT AND AGENT DETAILS

### Applicant

Novo Nordisk A/S  
Novo Allé  
DK-2880 Bagsvaerd  
DENMARK

### Agent

SMART & BIGGAR LP  
1100-150 York street, TORONTO, ONTARIO,  
M5H3S5

## TRADEMARK DETAILS

# WegovyCare

### Trademark Type

Standard Characters

### Goods

#### Class 09

Electronic publications, namely, leaflets, books, booklets, handouts, magazines as well as medical, instructional and teaching material in the field of obesity; electronic reports featuring results from clinical trials and studies in the field of prevention and treatment of obesity; software applications for use with mobile devices for monitoring and the management of obesity; computer hardware and software, for use with medical injection devices for collecting, transmitting, and displaying medical data; medical software for the management of obesity; downloadable software as a medical device [SaMD] used to design and monitor pharmaceutical treatment plans, track patient compliance and verify treatment outcomes of prescription medication in the field of obesity management; downloadable software in the nature of a mobile application for the treatment of obesity, for use by patients and healthcare professionals.

### Services

#### Class 44

Providing medical information in the field of obesity and long-term maintenance of weight loss.

**Application Number** 2,144,840  
**International Registration Number** 1623493  
**Language of Application** English

**Filing Date** 2021-05-13

## APPLICANT AND AGENT DETAILS

### Applicant

24 Watts UK Limited  
7 Pilgrim Street  
London EC4V 6LB  
UNITED KINGDOM

### Agent

CPST INTELLECTUAL PROPERTY INC.  
130 Queens Quay East, East Tower, Suite  
809, Toronto, ONTARIO, M5A0P6

## TRADEMARK DETAILS

# COZMO & FRIENDS

### Trademark Type

Standard Characters

### Goods

#### Class 09

Apparatus for recording, transmitting or reproduction of sound, music, images, data and videos, namely audio cassette recorders, audio tape recorders, DVD recorders, tape recorders, video recorders, video tape recorders, audio mixers, sound mixers, microphones, radios, audio speakers, stereo speakers, headphones, earphones and cameras; recording materials, namely computer hardware used for storage and transmission of digital and analogue data, images, sounds and recordings; pre-recorded audio and video media, CDs, DVDs, CD-ROMS, DVD-ROMS, digital audio tapes, digital video tapes, digital audio cassettes, digital video cassettes, high definition video discs, mini audio discs, mini video discs, audio records, audio tapes, video tapes, audio cassettes, video cassettes, audio discs, video discs, portable audio players, portable video players, USB flash drives, portable flash drives and downloadable digital files featuring children's television series, animated films and television shows, learning activities for children, games, stories, music, musical recordings, musical performances, artistic performances, appearances by a celebrity or celebrities, appearances by professional entertainers all aimed at children; laser-read discs for recording, reproducing, transmitting and playing sound, images, music, data or video; optical-read discs for recording, reproducing, transmitting and playing sound, images, music, data or video; audio, image, data and video files provided from the Internet; audio files in MP3 format; audio and/or video files in electronic format provided from the Internet; video files in MP4 format; MP4 videos; downloadable application software for mobile devices, tablet computers and smartphones for browsing and accessing computer games, audio works, visual works, audiovisual works, electronic publications, books, movies, and music all aimed at children; mouse mats; video game software, programmes and cartridges; downloadable digital music or sound files provided from the Internet; downloadable digital video, image and data files provided from the Internet; downloadable digital video, image and data files provided from MP4 web sites on the Internet; refrigerator magnets; downloadable electronic data files featuring children's television series, animated entertainment, learning activities for children, games, stories, music, musical recordings, musical performances, artistic performances, appearances by a celebrity or celebrities, appearances by professional entertainers all aimed at children; publications downloaded in

electronic form from the Internet, namely, books and magazine, all aimed at children, featuring children's stories and children's entertainment all aimed at children; downloadable electronic publications provided from databases and the Internet namely, book, magazine, manual featuring children's stories and children's entertainment; e-books; audio books on CD, mini-disc, record, cassette or disc; talking books; printed matter in electronic form, namely books, magazines, and manual featuring children's stories and children's entertainment all aimed at children; on-line publications, magazines, periodicals and newspapers; photographs and stills in electronic form; sunglasses, eyewear and cases therefor.

## Services

### Class 41

Entertainment in the nature of television shows for children; entertainer services, namely, live, televised and movie appearances by a professional entertainer; scriptwriting services; preparation, presentation, writing, direction and production of radio, television, satellite, cinema and cable television programmes, films, radio programmes and stage shows; distribution of radio, satellite and television programmes; education, namely classes for children in the field of science, technology, engineering and mathematics (STEM); audio production services; provision of facilities for the production of films, and television and radio programmes; provision of live entertainment, namely children's variety entertainment featuring presentation of live show performances, live music concerts, children's variety shows and live radio personality performances; provision of live performances namely, live theatrical and musical performances; provision of live shows namely, children's variety entertainment featuring presentation of live show performances, live music concerts, children's variety shows and live radio personality performances; film and motion picture production; production of animated cartoons; production of audio-visual presentations; production of entertainment in the form of a television or radio series; production of television shows; production of sound recordings; production of special effects for films, radio and television; arranging and conducting of sporting events; production of training films and training videos; rental of facilities for the production of television and radio programmes; publication of books; syndication of radio and television programmes; editing of film, videos, sound, audio, television, radio and cinema film recordings; recording of entertainment in the form of video, DVD, CD film and sound in the fields of music, video, films; arrangement and performance of dance, music and drama, namely, musical plays; arrangement and performance of dance, music and drama; arrangement and performance of radio and television programmes, films, shows, and/or recordings of sound, music or images; arrangement and production of theatrical and stage entertainment; arranging and conducting of lectures, demonstrations, displays, exhibitions, presentations, seminars, concerts, gigs, shows events, and festivals for educational, entertainment, teaching and training purposes; conducting instructional, teaching and coaching classes, courses, seminars, presentations, shows and workshops; electronic library services for the supply of electronic information in the form of electronic texts, audio and/or video information and data, games and amusements; providing on-line non-downloadable publications; providing digital sound, music and video recordings, not downloadable, from the Internet; providing digital sound, music and video recordings, not downloadable, from MP3 and MP4 Internet websites; providing digital sound recordings, not downloadable, from the Internet; providing digital sound recordings, not downloadable, from MP3 Internet websites; providing digital music and sound recordings, not downloadable, from the Internet; providing digital music and sound recordings, not downloadable, from MP3 Internet websites; providing digital video, image, film, radio and TV recordings and programmes, not downloadable, from the Internet; providing digital video, image, film, radio and TV recordings and programmes, not downloadable, from MP4 Internet websites; providing information in the field of children's entertainment, namely music, video, films and musical plays; entertainment services,

namely, providing online electronic computer and video games; providing non-downloadable interactive multiplayer computer and video games that may be accessed and played over computer networks and global communications networks; information, advisory and consultancy services in the field of children's entertainment, namely television shows, music, videos, films, musical plays, theatrical stage performances and video games.

**Claims**

Priority Filing Date: April 30, 2021, Country or Office: UNITED KINGDOM, Application No: UK00003635461 in association with the same kind of goods and in association with the same kind of services

**Application Number** 2,146,248  
**International Registration Number** 1624732  
**Language of Application** English

**Filing Date** 2021-05-04

## APPLICANT AND AGENT DETAILS

### Applicant

Nordic Basic Wear A/S  
Grumstolsvej 4  
DK-8270 Højbjerg  
DENMARK

### Agent

GOWLING WLG (CANADA) LLP  
1 MAIN STREET WEST, HAMILTON,  
ONTARIO, L8P4Z5

## TRADEMARK DETAILS

# GAI+LISVA

### Trademark Type

Standard Characters

### Goods

#### Class 24

(1) Textile and textile goods, namely, fabrics for textile use; bed covers; plastic table covers; hand towels; bed linen; pillowcases; textile tablecloths; children's blankets; textile table linen; curtains; textile kitchen and table linens; throws; bed clothes, namely, blankets; textile fabrics in the piece, namely fabrics for textile use; bed blankets; oilcloth for use as tablecloths

#### Class 25

(2) Clothing, namely, shirts, dresses, skirts, pants, underwear, pajamas, yoga tops, yoga pants, coats, jackets and shorts; footwear, namely shoes; headwear, namely hats and beanies

**Application Number** 2,146,426  
**International Registration Number** 1624844  
**Language of Application** French

**Filing Date** 2021-08-20

## APPLICANT AND AGENT DETAILS

### Applicant

Philip Morris Products S.A.  
Quai Jeanrenaud 3  
CH-2000 Neuchâtel  
SUISSE

### Agent

GOWLING WLG (CANADA) LLP  
SUITE 1600, 1 FIRST CANADIAN PLACE, 100  
KING STREET WEST, TORONTO, ONTARIO,  
M5X1G5

## TRADEMARK DETAILS

# TEREA SILVER

### Trademark Type

Standard Characters

### Goods

#### Class 34

Wired vaporizers for e-cigarettes and electronic smoking apparatus, namely portable heating apparatus and portable generators for the inhalation of an aerosol containing nicotine; raw or manufactured tobacco; tobacco products, including cigars, cigarettes, cigarillos, tobacco for roll-your-own cigarettes, tobacco for pipes, chewing tobacco, snuff, kretek; snus; tobacco substitutes other than for medical use, namely liquid nicotine solutions for use in e-cigarettes; smokers' articles in the nature of cigarette papers and tubes, filters for cigarettes, tobacco boxes, cigarette cases and ashtrays, smoking pipes, pocket-size cigarette rolling machines, lighters for smokers; matches; tobacco sticks, heatable tobacco products, electronic apparatus and their parts, for heating cigarettes or tobacco in order to release aerosols containing nicotine inhalants; liquid nicotine solutions for use in e-cigarettes; electronic smoking apparatus, namely portable electronic heaters; e-cigarettes; e-cigarettes used as substitutes for traditional cigarettes; electronic devices, namely portable heating apparatus and portable generators for the inhalation of aerosols containing nicotine; oral vaporizers for smokers, tobacco products and tobacco substitutes; smokers' articles for e-cigarettes, namely atomizers for cigarettes, cartridges, envelopes, caps, bands, springs, cleaning kits for e-cigarettes, namely cleaning rods and cleaning brushes, e-cigarette boxes, tobacco flavourings and liquid flavouring solutions for e-cigarettes, and parts and components for the aforesaid goods; fire-extinguishing apparatus for cigarettes and cigars, as well as heated tobacco sticks; cases for rechargeable e-cigarettes.

### Claims

Priority Filing Date: February 23, 2021, Country or Office: ALBANIA, Application No: AL/T/2021/220 in association with the same kind of goods

**Application Number** 2,146,599  
**International Registration Number** 1625529  
**Language of Application** English

**Filing Date** 2021-10-05

## APPLICANT AND AGENT DETAILS

### Applicant

Merck Sharp & Dohme B.V.  
Waarderweg 39  
NL-2031 BN HAARLEM  
NETHERLANDS

### Agent

BORDEN LADNER GERVAIS LLP  
Bay Adelaide Centre, East Tower, 22 Adelaide  
St. West, TORONTO, ONTARIO, M5H4E3

## TRADEMARK DETAILS

# OQANMI

### Trademark Type

Standard Characters

### Goods

#### Class 05

Pharmaceutical preparations and substances for use in oncology

### Claims

Priority Filing Date: October 01, 2021, Country or Office: Benelux Office for IP (BOIP), Application No: 1451122 in association with the same kind of goods



**Application Number** 2,146,646  
**International Registration Number** 1074695  
**Language of Application** English

**Filing Date** 2021-10-11

## APPLICANT DETAILS

**Applicant**  
REDBOND COMPOSITES, S.L.  
Avenida de Elche, 164  
E-03008 ALICANTE  
SPAIN

## TRADEMARK DETAILS

# REDBOND

**Trademark Type**  
Standard Characters

**Goods**

**Class 06**

Metal facade panels for construction purposes; metal gates and fencing panels; metal floor panels; metal coverings for ceilings.

**Application Number** 2,148,079  
**International Registration Number** 1583700  
**Language of Application** English

**Filing Date** 2021-10-08

## APPLICANT DETAILS

**Applicant**  
FUJITEC KABUSHIKI KAISHA(also trading as  
FUJITEC CO., LTD.)  
591-1, Miyata-cho,  
Hikone-shi  
Shiga 522-8588  
JAPAN

## TRADEMARK DETAILS

**Trademark Type**  
Design

**Visual Representation**



### Colour Claim

Colour is claimed as a feature of the trademark. Blue and Black. The mark consists of the stylized wording "AirTap" in black and a design element in blue. There exists a slanted oval in blue superimposed over the wording, to the left of which a pair of three curved lines of varying lengths and thicknesses appears symmetrical in blue.

### Goods

**Class 07**

Elevators; escalators; dumbwaiter elevators; moving walkways; conveyer belts; mechanical parking systems; mechanical bicycle parking systems; control systems for elevators, escalators, dumbwaiter elevators, moving walkways and conveyer belts; control systems for mechanical parking systems and mechanical bicycle parking systems.

**Application Number** 2,149,389  
**International Registration Number** 1627998  
**Language of Application** French

**Filing Date** 2021-01-05

## APPLICANT DETAILS

**Applicant**  
Maxime Poujaud  
6 Mas Martegal  
F-13220 Chateauneuf-les-martigues  
FRANCE

## TRADEMARK DETAILS

**Trademark Type**  
Design

**Visual Representation**

# SmartyPhor

### Goods

#### Class 09

(1) Smart watches.

#### Class 14

(2) Watch bands.

**Application Number** 2,149,538  
**International Registration Number** 1628828  
**Language of Application** English

**Filing Date** 2021-08-17

## APPLICANT DETAILS

### Applicant

Bayerische Motoren Werke Aktiengesellschaft  
Petuelring 130  
80809 München  
GERMANY

## TRADEMARK DETAILS

# ACEMAN

### Trademark Type

Standard Characters

### Goods

#### Class 12

(1) Automobiles and structural parts of automobiles

#### Class 28

(2) Miniature cars, toy cars, scale model vehicles

### Claims

Priority Filing Date: March 31, 2021, Country or Office: GERMANY, Application No: 30 2021 105 619 in association with the same kind of goods

**Application Number** 2,149,792  
**International Registration Number** 1628048  
**Language of Application** English

**Filing Date** 2021-10-20

## APPLICANT AND AGENT DETAILS

### Applicant

Point380, Inc.  
1221 Pennsylvania Ave., Ste. 200  
Boulder CO 80302  
UNITED STATES OF AMERICA

### Agent

BERESKIN & PARR LLP/S.E.N.C.R.L., S.R.L.  
SCOTIA PLAZA, 40 KING STREET WEST,  
40th FLOOR, TORONTO, ONTARIO, M5H3Y2

## TRADEMARK DETAILS

# OPTERA

### Trademark Type

Standard Characters

### Services

#### Class 35

(1) Business consulting in the field of environmental management, namely, advising businesses and individuals on issues of environmental impact, conservation, preservation and protection, and economic analysis for business purposes; business consulting and advisory services relating to environmental sustainability goals and their integration into business processes and operations; business consulting service that provides strategies to companies wishing to move towards sustainability and socially responsible business practices; consulting and advisory services in the area of environmental sustainability, including the evaluation of company operations, finances, infrastructure projects, and service contracts in relation to environmental sustainability, efficiency, and economic impact; consulting services in the area of sustainable business solutions; consulting in the area of corporate environmental sustainability strategy; expert evaluations and reports relating to businesses' greenhouse gas emissions, sustainability objectives, environmental impact, and renewable energy procurement strategy; preparation of business reports; providing information in the area of global sustainable business solutions.

#### Class 42

(2) Software as a service (SAAS) services featuring databases and software tools for management, tracking, optimization, report generation, forecasting, and analysis of emissions, energy, water, materials and waste management in connection with business operations, manufacturing, construction, logistics, product use and supply chains.

### Claims

Priority Filing Date: April 23, 2021, Country or Office: UNITED STATES OF AMERICA, Application No: 90667566 in association with the same kind of services

**Application Number** 2,150,978  
**International Registration Number** 1629545A  
**Language of Application** English

**Filing Date** 2021-07-21

## APPLICANT DETAILS

### Applicant

Nintendo of America Inc.  
4600 150th Avenue NE  
Redmond, Washington 98052  
UNITED STATES OF AMERICA

## TRADEMARK DETAILS

### Trademark Type

Design

### Visual Representation

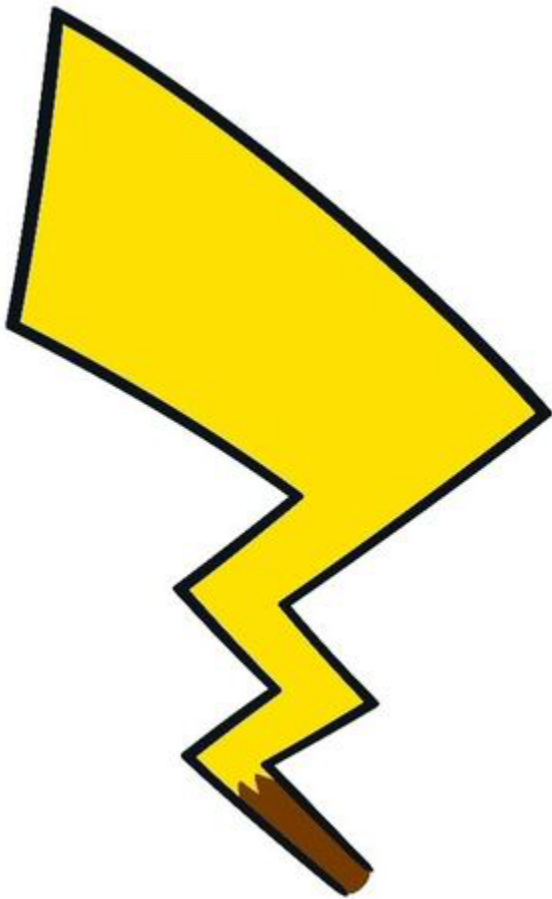

### Trademark Description

The mark consists of the tail of a fanciful creature that is depicted in a zig-zag shape, with the width of the tail narrowing from top-to-bottom, the upper-most portions of the tail depicted in yellow, the bottom portion of the tail depicted in brown, and the majority of the tail featuring a black outline.

**Colour Claim**

Colour is claimed as a feature of the trademark. Black, yellow, and brown. The mark consists of the tail of a fanciful creature that is depicted in a zig-zag shape, with the width of the tail narrowing from top-to-bottom, the upper-most portions of the tail depicted in yellow, the bottom portion of the tail depicted in brown, and the majority of the tail featuring a black outline.

**Goods****Class 09**

(1) Downloadable video game programs; video game cartridges; memory cards for video game machines; protective films adapted for smartphones; covers for smartphones; cases for smartphones; recorded computer game software; downloadable computer game software; downloadable image files containing artwork, text, audio, videos relating to video games and trading card games; downloadable music files; downloadable electronic publications, namely, downloadable e-books in the field of fiction stories, booklets and manuals in the field of video games and trading card games; batteries for mobile phones; headphones; earphones.

**Class 25**

(2) Clothing, namely polo shirts, sweatshirts, parkas, jackets, raincoats, pants, dresses, sweatpants, skirts, and sweaters; shirts; tee-shirts; pajamas; underwear; bathing suits; socks; scarves; muffler scarves; ear muffs; gloves; bibs, not of paper, namely cloth bibs and babies' bibs of plastic; hats; caps; cap peaks; belts; footwear, namely, athletic footwear, casual footwear, children's footwear, exercise footwear, infant footwear, rain footwear; sports shoes; sandals; slippers; masquerade costumes; Halloween costumes.

**Class 28**

(3) Games, namely card games, promotional game cards, puzzles, trading card games; toys, namely toy balls, toy key chains, toy figures, water toys, plush toys, inflatable toys, party favors in the nature of small toys, toy balloons, toy building blocks; stuffed toys; dolls; portable games with liquid crystal displays; handheld units for playing video games; protective films adapted for screens for portable games; video game machines; controllers for game consoles; arcade video game machines; trading cards for games; cases for trading cards for games; board games; playing cards; ornaments for Christmas trees, except lights, candles and confectionery; protective carrying cases specially adapted for handheld video games.

**Claims**

Priority Filing Date: January 22, 2021, Country or Office: JAPAN, Application No: 2021-007152 in association with the same kind of goods



**Application Number** 2,151,103  
**International Registration Number** 1629254  
**Language of Application** English

**Filing Date** 2021-09-17

## APPLICANT AND AGENT DETAILS

### Applicant

Guangzhou Borui Cosmetics Co. LTD  
No. 3-1, 3rd Floor,  
Guangzhou Hongding Building, No. 561,  
Yuncheng East Road, Sanyuanli Street,  
Baiyun District, Guangzhou City  
Guangdong Province  
CHINA

### Agent

JAMIE BASHTANYK  
(TRADEMARK DEPOT), 3772 De La  
Goudrelle, Saint-Lazare, QUEBEC, J7T2N1

## TRADEMARK DETAILS

### Trademark Type

Design

### Visual Representation



### Goods

#### Class 03

All purpose cleaning preparations; facial cleansing lotion; skin polishing preparations; Grinding preparations, namely abrasives for re-surfacing material before painting; perfumery; cosmetics; Cosmetic skin cleansing solutions; toothpaste; incense; air fragrance; lipsticks; beauty masks; perfume.

**Application Number** 2,151,205  
**International Registration Number** 1630532  
**Language of Application** French

**Filing Date** 2021-10-14

## APPLICANT DETAILS

**Applicant**  
L'OREAL  
14 rue Royale  
F-75008 Paris  
FRANCE

## TRADEMARK DETAILS

**Trademark Type**  
Design

**Visual Representation**

# AIRY DEFENSE TECHNOLOG

### Goods

#### Class 01

(1) Chemical products used in the composition of cosmetic products for skin care.

#### Class 03

(2) Cosmetic and make-up products.

### Claims

Priority Filing Date: July 21, 2021, Country or Office: FRANCE, Application No: 4786970 in association with the same kind of goods

**Application Number** 2,151,662  
**Language of Application** English

**Filing Date** 2021-12-03

## APPLICANT AND AGENT DETAILS

### Applicant

Ya Zong  
No.12, Hedong Group  
Songgang Village, Zhuwan Town  
Dingyuan County, Anhui Province, 233200  
CHINA

### Agent

PAUL B. BÉLANGER  
4360 av de Hampton, MONTRÉAL, QUEBEC,  
H4A2L2

## TRADEMARK DETAILS

# BBOHSS

### Trademark Type

Standard Characters

### Goods

#### Class 25

adhesive bras; bras; clothing belts; corselets; girdles; gloves; hosiery; latex costumes; layettes; leather belts; masquerade costumes; money belts; shawls; sock suspenders; spiked running shoes; sports clothing; suits; suits of leather; suspender braces; underwear

**Application Number** 2,152,565  
**International Registration Number** 1632164  
**Language of Application** English

**Filing Date** 2021-06-18

## APPLICANT DETAILS

### Applicant

Metametrics, Inc.  
800 Taylor Street,  
Suite 102  
Durham NC 27701  
UNITED STATES OF AMERICA

## TRADEMARK DETAILS

# LEXILE

### Trademark Type

Standard Characters

### Services

#### Class 42

- (1) Providing temporary use of on-line non-downloadable software for analyzing text difficulty and providing a measurement of text difficulty
- (2) Providing temporary use of on-line non-downloadable software for analyzing audio recordings and providing a measurement of reading comprehension and reading ability

### Claims

Priority Filing Date: April 20, 2021, Country or Office: UNITED STATES OF AMERICA, Application No: 90658330 in association with the same kind of services (2)

**Application Number** 2,152,610  
**International Registration Number** 1632087  
**Language of Application** English

**Filing Date** 2021-07-27

## APPLICANT DETAILS

### Applicant

Bath & Body Works Brand Management, Inc.  
Seven Limited Parkway  
Reynoldsburg OH 43068  
UNITED STATES OF AMERICA

## TRADEMARK DETAILS

# SUN-DRENCHED LINEN

### Trademark Type

Standard Characters

### Goods

#### Class 03

(1) Personal care products, namely, hand soaps, air fragrance reed diffusers, room fragrances, room fragrance refills for electric and non-electric room fragrance dispensers, scented oils used to produce aromas when heated, scented room sprays, home fragrance oils.

#### Class 04

(2) Candles.

#### Class 05

(3) Hand-sanitizing preparations.

### Claims

Priority Filing Date: January 30, 2021, Country or Office: UNITED STATES OF AMERICA,  
Application No: 90499757 in association with the same kind of goods

**Application Number** 2,152,657  
**International Registration Number** 1632210  
**Language of Application** English

**Filing Date** 2021-08-24

## APPLICANT DETAILS

### Applicant

CTC Global Corporation  
2026 McGaw Avenue  
Irvine CA 92614  
UNITED STATES OF AMERICA

## TRADEMARK DETAILS

# ACCC

### Trademark Type

Standard Characters

### Services

#### Class 42

Engineering services in the nature of engineering consultation related to the installation of overhead electrical lines; engineering consultation services for the selection of components for overhead electrical lines; engineering consultation services for the preparation of bids relating to the installation of overhead electrical lines.

**Application Number** 2,152,868  
**International Registration Number** 1631510  
**Language of Application** French

**Filing Date** 2021-10-20

## APPLICANT AND AGENT DETAILS

**Applicant**  
CHATEAU DE LA CASSEMICHÈRE  
LA CASSEMICHÈRE  
F-44330 LA CHAPELLE-HEULIN  
FRANCE

**Agent**  
ROBIC  
630, boul. René-Lévesque Ouest, 20e étage,  
Montréal, QUÉBEC, H3B1S6

## TRADEMARK DETAILS

# CASSEMICHÈRE

**Trademark Type**  
Standard Characters

**Goods**

**Class 33**

Alcoholic beverages, namely wines.

**Claims**

Priority Filing Date: April 26, 2021, Country or Office: FRANCE, Application No: 4759678 in association with the same kind of goods

**Application Number** 2,152,908  
**International Registration Number** 1632281  
**Language of Application** English

**Filing Date** 2021-10-25

## APPLICANT DETAILS

**Applicant**  
OSI INDUSTRIES, LLC  
1225 Corporate Boulevard  
Aurora IL 60505  
UNITED STATES OF AMERICA

## TRADEMARK DETAILS

**Trademark Type**  
Design

**Visual Representation**



**Food  
Safety  
Always  
Look out.**





**Speak up.**  
**Act now.**

### **Trademark Description**

The mark consists of exclamation point over crescent moon shape next to the words Food over the words Safety over the words Always over the words Look out. over the words Speak up. over the words Act now.

### **Services**

#### **Class 35**

(1) Promoting awareness of food safety.

#### **Class 41**

(2) Virtual training services in the field of food safety; arranging and conducting of training courses in the field of food safety; arranging and conducting of training workshops in the field of food safety; providing training in the field of food safety; consulting services in the field of food safety; training services in the field of food safety; educational services, namely, conducting classes, seminars, conferences, workshops in the field of food safety and distribution of training material in connection therewith; educational services, namely, conducting programs in the field of food safety advocacy.

### **Claims**

Priority Filing Date: August 24, 2021, Country or Office: UNITED STATES OF AMERICA,  
Application No: 90900004 in association with the same kind of services

**Application Number** 2,152,915  
**International Registration Number** 1631830  
**Language of Application** English

**Filing Date** 2021-10-26

## APPLICANT DETAILS

### Applicant

Sascha Katzenstein  
Alte Langgasse 23  
63457 Hanau  
GERMANY

## TRADEMARK DETAILS

# Dipoxy

### Trademark Type

Standard Characters

### Goods

#### Class 08

(1) Hand tools and hand-operated implements, in particular spatulas for paint.

#### Class 09

(2) Measuring cups and pipettes, in particular for measuring and mixing paint.

#### Class 17

(3) Adhesive tapes, adhesive strips and adhesive films, in particular for mold making; silicone rubber for mold making.

### Claims

Priority Filing Date: April 28, 2021, Country or Office: GERMANY, Application No: 30 2021 107 532  
in association with the same kind of goods

**Application Number** 2,152,925  
**International Registration Number** 1630989  
**Language of Application** English

**Filing Date** 2021-10-26

## APPLICANT AND AGENT DETAILS

### Applicant

Apple Inc.  
One Apple Park Way  
Cupertino CA 95014  
UNITED STATES OF AMERICA

### Agent

BAKER & MCKENZIE LLP  
BROOKFIELD PLACE, 181 BAY STREET,  
SUITE 2100, P.O. BOX 874, TORONTO,  
ONTARIO, M5J2T3

## TRADEMARK DETAILS

# APPLE AIRTAG

### Trademark Type

Standard Characters

### Goods

#### Class 14

Key chains; key rings.

### Claims

Priority Filing Date: May 04, 2021, Country or Office: JAMAICA, Application No: 83234 in association with the same kind of goods

**Application Number** 2,152,932  
**International Registration Number** 1632304  
**Language of Application** English

**Filing Date** 2021-10-26

## APPLICANT AND AGENT DETAILS

### Applicant

Zimmer, Inc.  
345 East Main Street  
Warsaw IN 46580  
UNITED STATES OF AMERICA

### Agent

SMART & BIGGAR LP  
SUITE 900, 55 METCALFE STREET, P.O.  
BOX 2999, STATION D, OTTAWA, ONTARIO,  
K1P5Y6

## TRADEMARK DETAILS

# MOVING YOU FORWARD

### Trademark Type

Standard Characters

### Goods

#### Class 10

orthopedic joint implants composed of artificial materials

### Services

#### Class 44

Providing medical and patient health information in the orthopedic field; medical services in the field of pre-operative surgical planning for orthopedic implant procedures

### Claims

Priority Filing Date: May 27, 2021, Country or Office: UNITED STATES OF AMERICA, Application No: 90738729 in association with the same kind of goods; October 04, 2021, Country or Office: UNITED STATES OF AMERICA, Application No: 97058261 in association with the same kind of services

**Application Number** 2,152,948  
**International Registration Number** 1632295  
**Language of Application** English

**Filing Date** 2021-10-28

## APPLICANT DETAILS

### Applicant

MOEMENT, INC.  
7401 S. Sepulveda Blvd, Apt 119  
Los Angeles CA 90045  
UNITED STATES OF AMERICA

## TRADEMARK DETAILS

### Trademark Type

Design

### Visual Representation



### Trademark Description

The mark consists of the side profile of a dog head looking to the left, and to the right of the dog head, the word "MoeGo" wherein four ovals sit above the letter "e" to give the appearance of a dog paw.

### Goods

#### Class 09

Downloadable software for business management in the pet grooming, pet daycare, and veterinary fields, namely, for tracking time and expenses, budgeting, preparing, disseminating and processing invoices and payments, bookkeeping, processing and recording financial transaction data, preparing and managing work orders, sharing documents, electronic mail messaging, managing group product purchases, customer management, marketing management, scheduling management, inventory management, and employee management; mobile applications for business management in the pet grooming, pet daycare, and veterinary fields, namely, for tracking time and expenses, budgeting, preparing, disseminating and processing invoices and payments, bookkeeping, processing and recording financial transaction data, preparing and managing work orders, sharing documents, electronic mail messaging, managing group product purchases,

customer management, marketing management, scheduling management, inventory management, and employee management; downloadable software for financial services, namely, facilitating payment services, loan services, and payroll services; mobile applications for financial services, namely, facilitating payment services, loan services, and payroll services.

**Application Number** 2,152,954  
**International Registration Number** 1631698  
**Language of Application** English

**Filing Date** 2021-10-28

## APPLICANT AND AGENT DETAILS

### Applicant

Monahan Products, LLC  
276 Weymouth Road  
Rockland MA 02370  
UNITED STATES OF AMERICA

### Agent

RICHES, MCKENZIE & HERBERT LLP  
SUITE 1800, 2 BLOOR STREET EAST,  
TORONTO, ONTARIO, M4W3J5

## TRADEMARK DETAILS

# COVER MORE GROUND

### Trademark Type

Standard Characters

### Goods

#### Class 12

Strollers; jogging strollers; all-terrain strollers; folding strollers.

### Claims

Priority Filing Date: July 14, 2021, Country or Office: UNITED STATES OF AMERICA, Application No: 90828216 in association with the same kind of goods

**Application Number** 2,152,955  
**International Registration Number** 1631602  
**Language of Application** English

**Filing Date** 2021-10-28

## APPLICANT DETAILS

### Applicant

MOEMENT, INC.  
7401 S. Sepulveda Blvd, Apt 119  
Los Angeles CA 90045  
UNITED STATES OF AMERICA

## TRADEMARK DETAILS

# MOEGO

### Trademark Type

Standard Characters

### Goods

#### Class 09

Downloadable software for business management in the pet grooming, pet daycare, and veterinary fields, namely, for tracking time and expenses, budgeting, preparing, disseminating and processing invoices and payments, bookkeeping, processing and recording financial transaction data, preparing and managing work orders, sharing documents, electronic mail messaging, managing group product purchases, customer management, marketing management, scheduling management, inventory management, and employee management; mobile applications for business management in the pet grooming, pet daycare, and veterinary fields, namely, for tracking time and expenses, budgeting, preparing, disseminating and processing invoices and payments, bookkeeping, processing and recording financial transaction data, preparing and managing work orders, sharing documents, electronic mail messaging, managing group product purchases, customer management, marketing management, scheduling management, inventory management, and employee management; downloadable software for financial services, namely, facilitating payment services, loan services, and payroll services; mobile applications for financial services, namely, facilitating payment services, loan services, and payroll services.



**Application Number** 2,152,961  
**International Registration Number** 1631316  
**Language of Application** English

**Filing Date** 2021-10-28

## APPLICANT DETAILS

### Applicant

Cowbell Cyber, Inc.  
6800 Koll Center Parkway, Suite 210  
Pleasanton CA 94566  
UNITED STATES OF AMERICA

## TRADEMARK DETAILS

# MOO

### Trademark Type

Standard Characters

### Services

#### Class 42

Software as a service (SaaS) services featuring software for insurance risk assessment and underwriting; software as a service (SaaS) services featuring software for a technology data analytics platform using artificial intelligence and machine learning algorithms for insurance risk assessment and underwriting; software as a service (SaaS) services featuring software that aggregates data and populates insurance applications; software as a service (SaaS) services featuring software that analyzes a company's insurability with regard to property and casualty insurance and recommends coverage and policies based on a company's insurable threat exposure.

**Application Number** 2,152,962  
**International Registration Number** 1631313  
**Language of Application** English

**Filing Date** 2021-10-28

## APPLICANT DETAILS

### Applicant

Cowbell Cyber, Inc.  
6800 Koll Center Parkway, Suite 210  
Pleasanton CA 94566  
UNITED STATES OF AMERICA

## TRADEMARK DETAILS

# COWBELL

### Trademark Type

Standard Characters

### Services

#### Class 36

(1) Insurance services, namely, providing underwriting, issuing and administration of property and casualty insurance; consulting and information concerning insurance.

#### Class 42

(2) Software as a service (SaaS) services featuring software for insurance risk assessment and underwriting; software as a service (SaaS) services featuring software for a technology data analytics platform using artificial intelligence and machine learning algorithms for insurance risk assessment and underwriting; software as a service (SaaS) services featuring software that aggregates data and populates insurance applications; software as a service (SaaS) services featuring software that analyzes a company's insurability with regard to property and casualty insurance and recommends coverage and policies based on a company's insurable threat exposure.

**Application Number** 2,152,965  
**International Registration Number** 1632297  
**Language of Application** English

**Filing Date** 2021-10-29

## APPLICANT AND AGENT DETAILS

### Applicant

SSG Capital Advisors, LLC  
Tower Bridge, Suite 420  
300 Barr Harbor Drive West  
Conshohocken PA 19428  
UNITED STATES OF AMERICA

### Agent

PERLEY-ROBERTSON, HILL & MCDUGALL  
LLP  
1400 - 340 ALBERT STREET, OTTAWA,  
ONTARIO, K1R0A5

## TRADEMARK DETAILS

### Trademark Type

Design

### Visual Representation



INVESTMENT BANKING  
SPECIAL SITUATIONS

### Trademark Description

The mark consists of stylized "S" to the left of the word "SSG" over the words "CAPITAL ADVISORS, LLC" and separated by a line. The stylized words "INVESTMENT BANKING" are to the right of "SSG" and over the words "SPECIAL SITUATIONS".

### Disclaimer

The right to the exclusive use of the words "CAPITAL ADVISORS, LLC" AND "INVESTMENT BANKING SPECIAL SITUATIONS" is disclaimed apart from the trademark.

### Services

#### Class 36

Financial services, namely, investment banking, financial consulting in the field of mergers and acquisitions, private placements of senior debt, subordinated debt and equity securities to lenders and investors and financial restructuring services.

**Application Number** 2,152,968  
**International Registration Number** 1632292  
**Language of Application** English

**Filing Date** 2021-10-29

## APPLICANT DETAILS

### Applicant

Uproot Lint LLC  
8350 NW 52nd Ter.  
Suite 301 #309  
Miami FL 33166  
UNITED STATES OF AMERICA

## TRADEMARK DETAILS

# UPROOT CLEAN

### Trademark Type

Standard Characters

### Goods

#### Class 21

Scrapers for cleaning surfaces of natural or man-made fibers; hand-held scrapers for cleaning surfaces of natural or man-made fibers; scrapers for cleaning clothing, carpet, furniture, car seats, car mats and door mats; manually operated scrapers for cleaning surfaces comprising natural or man-made fibers.

### Claims

Priority Filing Date: July 07, 2021, Country or Office: UNITED STATES OF AMERICA, Application No: 90816004 in association with the same kind of goods

**Application Number** 2,153,020  
**International Registration Number** 1632316  
**Language of Application** English

**Filing Date** 2021-11-03

## APPLICANT DETAILS

### Applicant

Gilbarco Inc.  
7300 West Friendly Avenue  
Greensboro NC 27410  
UNITED STATES OF AMERICA

## TRADEMARK DETAILS

# EVERSE

### Trademark Type

Standard Characters

### Services

#### Class 37

(1) Installation, maintenance, and repair services for electric vehicle charging apparatuses and charging infrastructure; call center support services in the nature of technical advice concerning the maintenance and repair of electric vehicle charging apparatuses and charging infrastructure; call center support services in the nature of providing information and technical advice concerning the charging of electric vehicles.

#### Class 42

(2) Software as a service (SaaS) services featuring software for management of electric vehicle charging apparatuses and charging infrastructure; software as a service (SaaS) services featuring software for use with electric vehicle charging apparatuses and charging infrastructure, namely, for remote diagnostics, energy management, equipment scheduling, processing payments for vehicle charging sessions, and for collecting and reporting usage and utilization data; remote monitoring of the functioning and use of electric vehicle charging apparatuses and charging infrastructure; call center support services in the nature of technical support, namely, diagnosing problems with electric vehicle charging apparatuses and charging infrastructure; call center support services in the nature of troubleshooting of computer software problems pertaining to software relating to electric vehicle charging.

### Claims

Priority Filing Date: May 04, 2021, Country or Office: UNITED STATES OF AMERICA, Application No: 90689326 in association with the same kind of services

**Application Number** 2,153,025  
**International Registration Number** 1631622  
**Language of Application** English

**Filing Date** 2021-11-04

## APPLICANT AND AGENT DETAILS

### Applicant

Koniku Inc.  
2597 Kerner Boulevard  
San Rafael CA 94901  
UNITED STATES OF AMERICA

### Agent

CLARK WILSON LLP  
900 - 885 WEST GEORGIA STREET,  
VANCOUVER, BRITISH COLUMBIA, V6C3H1

## TRADEMARK DETAILS

### Trademark Type

Design

### Visual Representation



### Trademark Description

The mark consists of a stylized neuron curving in on itself with neurotransmitters that are between the apical and distal dendrites or axons; the wording "KONIKU" appears on the right.

### Foreign Character Translation

The translation provided by the applicant of the word KONIKU is immortal.

### Services

#### Class 42

Advanced product research in the field of artificial intelligence.

**Application Number** 2,153,065  
**International Registration Number** 1632127  
**Language of Application** English

**Filing Date** 2021-11-09

## APPLICANT AND AGENT DETAILS

### Applicant

ACTALIS SPA  
Via S. Clemente 53  
I-24036 Ponte San Pietro (Bergamo)  
ITALY

### Agent

OYEN WIGGS GREEN & MUTALA LLP  
480-THE STATION, 601 WEST CORDOVA  
STREET, VANCOUVER, BRITISH  
COLUMBIA, V6B1G1

## TRADEMARK DETAILS

### Trademark Type

Design

### Visual Representation



### Trademark Description

The mark consists of a large stylized triangle with three smaller triangles overlapping to the right-center of the large triangle, which is to the left of the word "ACTALIS" in capital letters.

### Goods

#### Class 09

Downloadable software for ensuring the security of electronic mail; encoded identity cards; encoded key cards.

### Services

#### Class 38

(1) Data communication by electronic mail; telecommunication services in the nature of providing telephone services with various telephone features, namely, a dedicated toll-free number,

voicemail, multiple mailbox extensions, telephone message notification, fax capabilities, detailed call reports, call waiting, call identification, call forwarding, and message waiting; transmission of electronic mail; voicemail services.

**Class 42**

(2) Computer security consultancy; computer security services in the nature of administering digital certificates; computer security threat analysis for protecting data; computer services, namely, encrypted data recovery services; computer services, namely, filtering of unwanted e-mails; data encryption services; data encryption and decoding services; design, development and implementation of software; electronic document and e-mail authentication services; electronic document and e-mail time-stamping services; electronic signature verification services using technology to authenticate user identity; providing user authentication services using single sign-on technology for online software applications; user authentication services using single sign-on technology for online software applications.

**Claims**

Priority Filing Date: September 27, 2021, Country or Office: UNITED STATES OF AMERICA, Application No: 97048068 in association with the same kind of goods and in association with the same kind of services



**Application Number** 2,153,072  
**International Registration Number** 1631379  
**Language of Application** English

**Filing Date** 2021-11-09

## APPLICANT AND AGENT DETAILS

### Applicant

Conveyor, Inc.  
548 Market Street, PMB 74941  
San Francisco CA 94104  
UNITED STATES OF AMERICA

### Agent

GOWLING WLG (CANADA) LLP  
SUITE 2600, 160 ELGIN STREET, OTTAWA,  
ONTARIO, K1P1C3

## TRADEMARK DETAILS

# CONVEYOR

### Trademark Type

Standard Characters

### Services

#### Class 42

Online non-downloadable software for security compliance, risk management, and data security.

### Claims

Priority Filing Date: June 11, 2021, Country or Office: UNITED STATES OF AMERICA, Application No: 90770069 in association with the same kind of services

**Application Number** 2,153,076  
**International Registration Number** 1631365  
**Language of Application** English

**Filing Date** 2021-11-09

## APPLICANT AND AGENT DETAILS

### Applicant

Vertex Pharmaceuticals Incorporated  
50 Northern Avenue  
Boston MA 02210  
UNITED STATES OF AMERICA

### Agent

PERLEY-ROBERTSON, HILL & MCDOUGALL  
LLP  
1400 - 340 ALBERT STREET, OTTAWA,  
ONTARIO, K1R0A5

## TRADEMARK DETAILS

# REXFOCAS

### Trademark Type

Standard Characters

### Goods

#### Class 05

Pharmaceutical preparations for the treatment of blood disorders; pharmaceutical preparations for the treatment of thalassemia and sickle cell disease.

### Claims

Priority Filing Date: October 28, 2021, Country or Office: UNITED STATES OF AMERICA,  
Application No: 97096667 in association with the same kind of goods

**Application Number** 2,153,079  
**International Registration Number** 1631363  
**Language of Application** English

**Filing Date** 2021-11-09

## APPLICANT AND AGENT DETAILS

### Applicant

Vertex Pharmaceuticals Incorporated  
50 Northern Avenue  
Boston MA 02210  
UNITED STATES OF AMERICA

### Agent

PERLEY-ROBERTSON, HILL & MCDUGALL  
LLP  
1400 - 340 ALBERT STREET, OTTAWA,  
ONTARIO, K1R0A5

## TRADEMARK DETAILS

# AYMVOKE

### Trademark Type

Standard Characters

### Goods

#### Class 05

Pharmaceutical preparations for the treatment of blood disorders; pharmaceutical preparations for the treatment of thalassemia and sickle cell disease.

### Claims

Priority Filing Date: October 28, 2021, Country or Office: UNITED STATES OF AMERICA,  
Application No: 97096645 in association with the same kind of goods

**Application Number** 2,153,080  
**International Registration Number** 1631362  
**Language of Application** English

**Filing Date** 2021-11-09

## APPLICANT AND AGENT DETAILS

### Applicant

Vertex Pharmaceuticals Incorporated  
50 Northern Avenue  
Boston MA 02210  
UNITED STATES OF AMERICA

### Agent

PERLEY-ROBERTSON, HILL & MCDUGALL  
LLP  
1400 - 340 ALBERT STREET, OTTAWA,  
ONTARIO, K1R0A5

## TRADEMARK DETAILS

# VOXVOKA

### Trademark Type

Standard Characters

### Goods

#### Class 05

Pharmaceutical preparations for the treatment of blood disorders; pharmaceutical preparations for the treatment of thalassemia and sickle cell disease.

### Claims

Priority Filing Date: October 28, 2021, Country or Office: UNITED STATES OF AMERICA,  
Application No: 97096624 in association with the same kind of goods

**Application Number** 2,153,081  
**International Registration Number** 1631361  
**Language of Application** English

**Filing Date** 2021-11-09

## APPLICANT AND AGENT DETAILS

### Applicant

Vertex Pharmaceuticals Incorporated  
50 Northern Avenue  
Boston MA 02210  
UNITED STATES OF AMERICA

### Agent

PERLEY-ROBERTSON, HILL & MCDUGALL  
LLP  
1400 - 340 ALBERT STREET, OTTAWA,  
ONTARIO, K1R0A5

## TRADEMARK DETAILS

# VOZME

### Trademark Type

Standard Characters

### Goods

#### Class 05

Pharmaceutical preparations for the treatment of blood disorders; pharmaceutical preparations for the treatment of thalassemia and sickle cell disease.

### Claims

Priority Filing Date: October 28, 2021, Country or Office: UNITED STATES OF AMERICA,  
Application No: 97096659 in association with the same kind of goods

**Application Number** 2,153,082  
**International Registration Number** 1631360  
**Language of Application** English

**Filing Date** 2021-11-09

## APPLICANT AND AGENT DETAILS

### Applicant

Vertex Pharmaceuticals Incorporated  
50 Northern Avenue  
Boston MA 02210  
UNITED STATES OF AMERICA

### Agent

PERLEY-ROBERTSON, HILL & MCDOUGALL  
LLP  
1400 - 340 ALBERT STREET, OTTAWA,  
ONTARIO, K1R0A5

## TRADEMARK DETAILS

# CASGEVY

### Trademark Type

Standard Characters

### Goods

#### Class 05

Pharmaceutical preparations for the treatment of blood disorders; pharmaceutical preparations for the treatment of thalassemia and sickle cell disease.

### Claims

Priority Filing Date: October 28, 2021, Country or Office: UNITED STATES OF AMERICA,  
Application No: 97096682 in association with the same kind of goods

**Application Number** 2,153,083  
**International Registration Number** 1631358  
**Language of Application** English

**Filing Date** 2021-11-09

## APPLICANT AND AGENT DETAILS

### Applicant

Vertex Pharmaceuticals Incorporated  
50 Northern Avenue  
Boston MA 02210  
UNITED STATES OF AMERICA

### Agent

PERLEY-ROBERTSON, HILL & MCDUGALL  
LLP  
1400 - 340 ALBERT STREET, OTTAWA,  
ONTARIO, K1R0A5

## TRADEMARK DETAILS

# MYVOIZA

### Trademark Type

Standard Characters

### Goods

#### Class 05

Pharmaceutical preparations for the treatment of blood disorders; pharmaceutical preparations for the treatment of thalassemia and sickle cell disease.

### Claims

Priority Filing Date: October 28, 2021, Country or Office: UNITED STATES OF AMERICA,  
Application No: 97096676 in association with the same kind of goods

**Application Number** 2,153,091  
**International Registration Number** 1631725  
**Language of Application** English

**Filing Date** 2021-11-10

## **APPLICANT DETAILS**

### **Applicant**

FibroGen, Inc.  
409 Illinois Street  
San Francisco CA 94158  
UNITED STATES OF AMERICA

## **TRADEMARK DETAILS**

# **EFREVIC**

### **Trademark Type**

Standard Characters

### **Goods**

#### **Class 05**

Pharmaceutical preparations for the treatment of chronic fibrotic and proliferative disorders; pharmaceutical preparations for the treatment of cancer, muscular dystrophy and idiopathic pulmonary fibrosis.

### **Claims**

Priority Filing Date: November 04, 2021, Country or Office: UNITED STATES OF AMERICA, Application No: 97109146 in association with the same kind of goods



**Application Number** 2,153,092  
**International Registration Number** 1631724  
**Language of Application** English

**Filing Date** 2021-11-10

## APPLICANT DETAILS

### Applicant

Aterian Investment Management, LP  
8th Floor, 550 Fifth Avenue  
New York NY 10036  
UNITED STATES OF AMERICA

## TRADEMARK DETAILS

# ATERIAN INVESTMENT PARTNERS

### Trademark Type

Standard Characters

### Services

#### Class 36

Financial services, namely, investment management and private equity fund investment services.

### Claims

Priority Filing Date: May 11, 2021, Country or Office: UNITED STATES OF AMERICA, Application No: 90703035 in association with the same kind of services

**Application Number** 2,153,094  
**International Registration Number** 1631535  
**Language of Application** English

**Filing Date** 2021-11-10

## APPLICANT DETAILS

### Applicant

FibroGen, Inc.  
409 Illinois Street  
San Francisco CA 94158  
UNITED STATES OF AMERICA

## TRADEMARK DETAILS

# CETGOFY

### Trademark Type

Standard Characters

### Goods

#### Class 05

Pharmaceutical preparations for the treatment of chronic fibrotic and proliferative disorders; pharmaceutical preparations for the treatment of cancer, muscular dystrophy and idiopathic pulmonary fibrosis.

### Claims

Priority Filing Date: November 04, 2021, Country or Office: UNITED STATES OF AMERICA, Application No: 97109149 in association with the same kind of goods

**Application Number** 2,153,095  
**International Registration Number** 1631534  
**Language of Application** English

**Filing Date** 2021-11-10

## APPLICANT AND AGENT DETAILS

### Applicant

Great Plains Manufacturing, Incorporated  
1525 E North Street  
Salina KS 67401  
UNITED STATES OF AMERICA

### Agent

GOWLING WLG (CANADA) LLP  
SUITE 1600, 1 FIRST CANADIAN PLACE, 100  
KING STREET WEST, TORONTO, ONTARIO,  
M5X1G5

## TRADEMARK DETAILS

# HARVEST STARTS HERE.

### Trademark Type

Standard Characters

### Goods

#### Class 07

Agricultural machinery and attachments, namely, fertilizer spreaders; agricultural machinery, namely, tillers; agricultural seed planting machine; agricultural seed planting machines, namely, sowers; agricultural implements, namely, seed drills.

**Application Number** 2,153,098  
**International Registration Number** 1631376  
**Language of Application** English

**Filing Date** 2021-11-10

## APPLICANT AND AGENT DETAILS

### Applicant

Baggu Corporation  
2415 3rd St., Suite 239  
San Francisco CA 94107  
UNITED STATES OF AMERICA

### Agent

GOWLING WLG (CANADA) LLP  
1 MAIN STREET WEST, HAMILTON,  
ONTARIO, L8P4Z5

## TRADEMARK DETAILS

# BAGGU

### Trademark Type

Standard Characters

### Goods

#### Class 20

(1) Pillows.

#### Class 25

(2) Headwear, namely, hats, beanies, fashion hats, beach hats, caps being headwear and visors being headwear.

### Claims

Priority Filing Date: May 13, 2021, Country or Office: UNITED STATES OF AMERICA, Application No: 90707839 in association with the same kind of goods

**Application Number** 2,153,099  
**International Registration Number** 1631367  
**Language of Application** English

**Filing Date** 2021-11-10

## APPLICANT DETAILS

### Applicant

The Better Tomorrow Project, LLC  
1680 Michigan Avenue, Ste. 817  
Miami Beach FL 33139  
UNITED STATES OF AMERICA

## TRADEMARK DETAILS

# ATMOFIZER

### Trademark Type

Standard Characters

### Goods

#### Class 11

Electric air disinfecting, purification, and sanitization units for commercial, domestic, hospital, and industrial use; electric units for disinfecting, purifying, and sanitizing spaces, water, surfaces, and air for commercial, domestic, hospital, and industrial use.

### Claims

Priority Filing Date: August 31, 2021, Country or Office: UNITED STATES OF AMERICA,  
Application No: 97003773 in association with the same kind of goods

**Application Number** 2,153,101  
**International Registration Number** 1631011  
**Language of Application** English

**Filing Date** 2021-11-10

## APPLICANT AND AGENT DETAILS

### Applicant

MAAX Spas Industries Corp.  
25605 South Arizona Avenue  
Chandler AZ 85248  
UNITED STATES OF AMERICA

### Agent

GOWLING WLG (CANADA) LLP  
1 PLACE VILLE MARIE, 37TH FLOOR/37E  
ETAGE, MONTREAL, QUEBEC, H3B3P4

## TRADEMARK DETAILS

# VITA SPA STR

### Trademark Type

Standard Characters

### Disclaimer

The right to the exclusive use of the word "SPA" is disclaimed apart from the trademark.

### Foreign Character Translation

The translation provided by the applicant of the word VITA is LIFE.

### Goods

#### Class 11

Hot tub jets; hot tubs; spa surrounds; spas in the nature of heated pools; water jets for use in hot tubs; water jets for use in swim spas; swim spas.

### Claims

Priority Filing Date: May 12, 2021, Country or Office: UNITED STATES OF AMERICA, Application No: 90706920 in association with the same kind of goods

**Application Number** 2,153,102  
**International Registration Number** 1632371  
**Language of Application** English

**Filing Date** 2021-11-10

## APPLICANT AND AGENT DETAILS

### Applicant

Reform Group Holdings ApS  
Otto Busses Vej 9  
DK-2450 Copenhagen SV  
DENMARK

### Agent

DLA PIPER (CANADA) LLP  
Suite 2800, PARK PLACE, 666 BURRARD  
STREET, VANCOUVER, BRITISH  
COLUMBIA, V6C2Z7

## TRADEMARK DETAILS

### Trademark Type

Design

### Visual Representation

The image shows the word "Reform" in a large, bold, black, sans-serif font. The letters are stylized with some unique proportions and spacing, particularly the 'R' and 'O'. The 'R' has a thick vertical stem and a curved top. The 'O' is a simple circle with a small gap at the bottom. The 'f' has a thick vertical stem and a curved top. The 'o' is a simple circle with a small gap at the bottom. The 'r' has a thick vertical stem and a curved top. The 'm' has a thick vertical stem and a curved top. The 'l' has a thick vertical stem and a curved top. The 'l' has a thick vertical stem and a curved top.

### Trademark Description

The mark consists of REFORM in stylized lettering.

### Goods

#### Class 20

Kitchen cabinets; bathroom cabinets; medicine cabinets; dish cabinets; furniture cabinets.

### Services

#### Class 37

Installation of kitchen cabinets; cabinet refacing.

### Claims

Priority Filing Date: May 11, 2021, Country or Office: UNITED STATES OF AMERICA, Application No: 90702763 in association with the same kind of goods and in association with the same kind of services

**Application Number** 2,153,103  
**International Registration Number** 1632363  
**Language of Application** English

**Filing Date** 2021-11-10

## APPLICANT DETAILS

**Applicant**  
AMOREPACIFIC CORPORATION  
100, Hangang-daero, Yongsan-gu  
Seoul  
REPUBLIC OF KOREA

## TRADEMARK DETAILS

# THERACNE

**Trademark Type**  
Standard Characters

### Goods

#### Class 03

Non-medicated toiletry preparations, namely, oils for toiletry purposes; essential oils for cosmetic purposes; lipsticks; make-up; hair colorants; cosmetic preparations for baths, namely, cosmetic bath oils, cosmetic bath powder and cosmetic bath salts; cosmetic preparations for skin care; skin cleansers; cosmetics for animals; cosmetic oils for the epidermis; preparations for permanent hair waves; cosmetics for the face and body; hair styling gel; cosmetic antiperspirants; lavender oil; perfumes, namely, fumigation preparations; cotton wool for cosmetic purposes; shampoos; cosmetic soaps; dentifrices.



**Application Number** 2,153,106  
**International Registration Number** 1631732  
**Language of Application** English

**Filing Date** 2021-11-11

## APPLICANT AND AGENT DETAILS

### Applicant

Get Together Inc.  
1748 Shattuck Avenue, No. 130  
Berkeley CA 94109  
UNITED STATES OF AMERICA

### Agent

SMART & BIGGAR LP  
1100-150 York street, TORONTO, ONTARIO,  
M5H3S5

## TRADEMARK DETAILS

# IN REAL LIFE

### Trademark Type

Standard Characters

### Goods

#### Class 09

Downloadable mobile application for social networking, calendaring, and planning.

### Services

#### Class 42

Providing temporary use of non-downloadable software for social networking, calendaring, and planning.

**Application Number** 2,153,107  
**International Registration Number** 1631731  
**Language of Application** English

**Filing Date** 2021-11-11

## APPLICANT AND AGENT DETAILS

### Applicant

Get Together Inc.  
1748 Shattuck Avenue, No. 130  
Berkeley CA 94109  
UNITED STATES OF AMERICA

### Agent

SMART & BIGGAR LP  
1100-150 York street, TORONTO, ONTARIO,  
M5H3S5

## TRADEMARK DETAILS

# IRL

### Trademark Type

Standard Characters

### Goods

#### Class 09

Downloadable mobile application for social networking, calendaring, and planning.

### Services

#### Class 42

Providing temporary use of non-downloadable software for social networking, calendaring, and planning.

**Application Number** 2,153,110  
**International Registration Number** 1631102  
**Language of Application** English

**Filing Date** 2021-11-11

## APPLICANT DETAILS

### Applicant

Heitman-Freeman  
1112 Rhinette Ave.  
Burlingame CA 94010  
UNITED STATES OF AMERICA

## TRADEMARK DETAILS

# Cardinal Stock

### Trademark Type

Standard Characters

### Goods

#### Class 25

Blouses; boots; dresses; hats; overcoats; shirts; shoes; skirts; socks; suits; sweatpants; sweatshirts; trousers; undergarments; athletic shoes; jackets; jerseys; tee shirts; tracksuits.

### Claims

Priority Filing Date: June 14, 2021, Country or Office: UNITED STATES OF AMERICA, Application No: 90772632 in association with the same kind of goods

**Application Number** 2,153,112  
**International Registration Number** 0822495  
**Language of Application** English

**Filing Date** 2021-11-11

## APPLICANT DETAILS

### Applicant

Twinbird Corporation  
2084-2, Yoshida-Nishiota,  
Tsubame-shi  
Niigata-ken 959-0292  
JAPAN

## TRADEMARK DETAILS

### Trademark Type

Design

### Visual Representation





The image shows a large, bold, black logo consisting of the letters 'SIC'. The 'S' is on the left, followed by a vertical line, and then the 'IC' on the right. The font is a heavy, sans-serif typeface.

**Goods****Class 11**

Stirling cycle coolers, gas refrigerators, ice machines, refrigerating machines, cooling evaporators, cooling domes, freezers, refrigerating or freezing showcases.

**Application Number** 2,153,155  
**International Registration Number** 1196879  
**Language of Application** French

**Filing Date** 2021-11-25

## APPLICANT DETAILS

### Applicant

Syngenta Participations AG  
Rosentalstrasse 67  
CH-4058 Basel  
SUISSE

## TRADEMARK DETAILS

# ATEXZO

### Trademark Type

Standard Characters

### Goods

### Class 05

Products for destroying vermin; fungicides, herbicides, insecticides, pesticides.

**Application Number** 2,153,302  
**Language of Application** English

**Filing Date** 2021-12-09

## APPLICANT AND AGENT DETAILS

### Applicant

Zhejiang TopSun Digital Technology Co., Ltd.  
1101-1 Bldg 17 No. 1008  
Xiangwang St Cangqian  
Sub-District Yuhang  
District Hangzhou City Zhejiang, 313200  
CHINA

### Agent

OSLER, HOSKIN & HARCOURT LLP  
Suite 320, World Exchange Plaza, 100 Queen  
Street, Ottawa, ONTARIO, K1P1J9

## TRADEMARK DETAILS

### Trademark Type

Design

### Visual Representation



EVER ADVANCED

### Goods

#### Class 10

(1) Adjustable sit-to-stand mobility aid for use by mobility-impaired individuals comprised of dual support handles and a frame that fits underneath chair cushions to assist users in transitioning from a sitting position to a standing position; electric massage chairs.

#### Class 25

(2) Gloves; hats; socks; shoes; coats

**Application Number** 2,153,848  
**Language of Application** French

**Filing Date** 2021-12-14

## APPLICANT AND AGENT DETAILS

### Applicant

Les solutions zéro déchet Fillgood Inc.  
B-108 Rue d'Amsterdam  
Saint-Augustin-de-Desmaures  
QUÉBEC  
G3A2R1

### Agent

BCF S.E.N.C.R.L./BCF LLP  
1100, boul. René-Lévesque Ouest, 25e Étage,  
Montréal, QUÉBEC, H3B5C9

## TRADEMARK DETAILS

# EENSY

### Trademark Type

Standard Characters

### Goods

#### Class 03

(1) Glass cleaner; spray cleaners for household use; toilet bowl cleaners; oven cleaners; hand cleansers; multi-purpose cleaning preparations; bath soap; beauty soap; body care soap; body cream soap; soap powder; body wash; hair care preparations.

#### Class 21

(2) Soap dispensers; dispensers for liquid soap for household purposes; soap dispensers; cleaning cloths.



**Application Number** 2,153,898  
**Language of Application** English

**Filing Date** 2021-12-14

## APPLICANT AND AGENT DETAILS

### Applicant

BlueTriton Brands, Inc.  
900 Long Ridge Road, Building 2  
Stamford, CT 06902  
UNITED STATES OF AMERICA

### Agent

BORDEN LADNER GERVAIS LLP  
World Exchange Plaza, 100 Queen Street,  
Suite 1300, Ottawa, ONTARIO, K1P1J9

## TRADEMARK DETAILS

# AC+ION

### Trademark Type

Standard Characters

### Goods

#### Class 32

Bottled water

### Claims

Priority Filing Date: August 13, 2021, Country or Office: UNITED STATES OF AMERICA,  
Application No: 90/882,355 in association with the same kind of goods

**Application Number** 2,154,293  
**International Registration Number** 1632549  
**Language of Application** English

**Filing Date** 2021-07-05

## APPLICANT DETAILS

**Applicant**  
SYNERGIA LIFE SCIENCES PVT. LTD.  
6/312, Jogani Indl. Complex,  
V. N. Purav Marg,  
Chunabhatti  
Mumbai 400022  
INDIA

## TRADEMARK DETAILS

**Trademark Type**  
Design

**Visual Representation**

**HU58**

**Goods**

**Class 01**

Bacterial preparations for the food industry; probiotic bacteria for the food industry (in food supplement); probiotic bacterial cultures for the food industry; chemical additives for use in the manufacture of food; antioxidants for use in the manufacture of food supplements.

**Application Number** 2,154,305  
**International Registration Number** 1633406  
**Language of Application** English

**Filing Date** 2021-07-14

## **APPLICANT DETAILS**

### **Applicant**

Automated Pet Care Products LLC  
1080 W Entrance Dr  
Auburn Hills MI 48326  
UNITED STATES OF AMERICA

## **TRADEMARK DETAILS**

### **Trademark Type**

Design

### **Visual Representation**

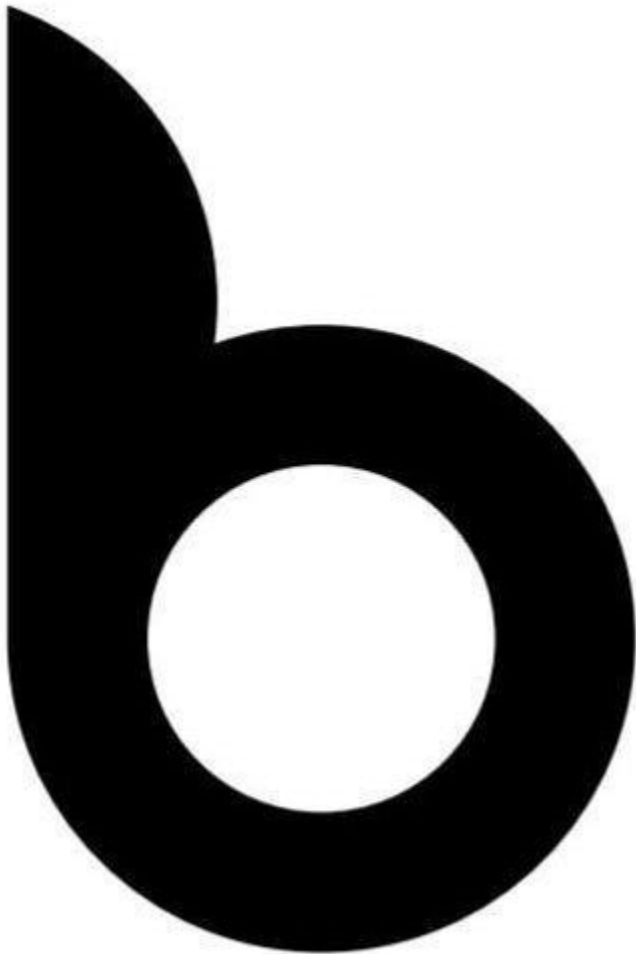

### **Trademark Description**

The mark consists of a stylized lowercase "b".

### **Goods**

**Class 27**

(1) Pet litter pan floor mats.

**Class 31**

(2) Cat litter.

**Claims**

Priority Filing Date: January 15, 2021, Country or Office: UNITED STATES OF AMERICA,  
Application No: 90469535 in association with the same kind of goods

**Application Number** 2,154,314  
**International Registration Number** 1632444  
**Language of Application** English

**Filing Date** 2021-07-20

## APPLICANT DETAILS

### Applicant

Painful Pleasures, LLC  
7410 Coca Cola Drive, Unit 108  
Hanover MD 21076  
UNITED STATES OF AMERICA

## TRADEMARK DETAILS

# PEAK NEEDLES

### Trademark Type

Standard Characters

### Disclaimer

The right to the exclusive use of the word "NEEDLES" is disclaimed apart from the trademark.

### Goods

#### Class 08

Tattoo needles and cartridges; tattoo grips; tattoo machines, power cords and replacement parts therefor; footpedals for use in connection with tattoo machines; footswitches for use in connection with tattoo machines; cases for tattoo machines.

### Services

#### Class 35

Online retail store services featuring tattoo machines, equipment, needles and cartridges, replacement parts, cases, electrical cords and supplies.

### Claims

Priority Filing Date: January 20, 2021, Country or Office: UNITED STATES OF AMERICA, Application No: 90476731 in association with the same kind of goods and in association with the same kind of services

**Application Number** 2,154,350  
**International Registration Number** 1633102  
**Language of Application** English

**Filing Date** 2021-08-13

## APPLICANT DETAILS

**Applicant**  
PHAM THI KIM LOAN  
No. 62 Ba Huyen Thanh Quan Streert,  
Ward 7, District 3  
Ho Chi Minh City  
VIET NAM

## TRADEMARK DETAILS

**Trademark Type**  
Design

**Visual Representation**

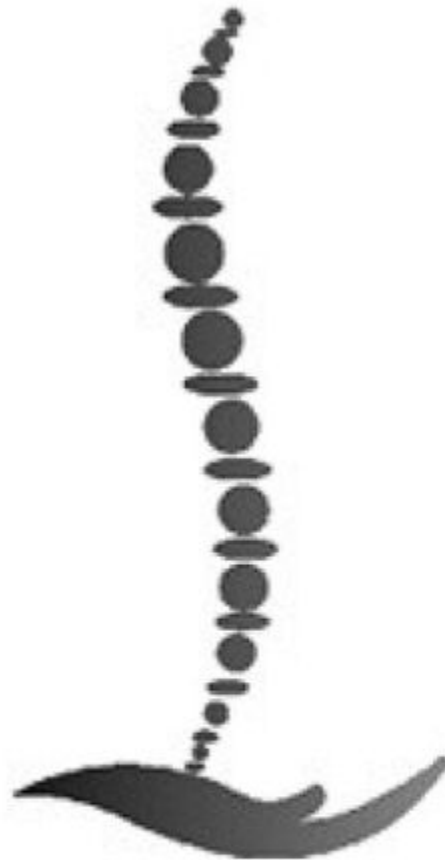

# DOCTORI OAN

**Trademark Description**

The mark consists of capital word "DOCTORLOAN" in black color, the word has no meaning. Above verbal elements is a device of a spine placed on the black curve.

**Goods****Class 10**

(1) Orthopedic shoes; orthopedic shoe soles; hypnogenesis pillows used for anti-insomnia; anti-pain cushions used on the patient's body; water mattresses used in medicine (hydrostatic cushions); armchairs used in medicine; beds with special structures used for medical care; heated blankets used in medicine; clothes for operating room; medical masks.

**Class 20**

(2) Wooden furniture namely tables, chairs, beds; cushions; pillows.

**Claims**

Priority Filing Date: July 09, 2021, Country or Office: VIET NAM, Application No: 4-2021-28491 in association with the same kind of goods

**Application Number** 2,154,361  
**International Registration Number** 1633581  
**Language of Application** English

**Filing Date** 2021-08-23

## APPLICANT AND AGENT DETAILS

### Applicant

Doctor Evidence, LLC  
508 12th St  
Santa Monica CA 90402  
UNITED STATES OF AMERICA

### Agent

CLARK WILSON LLP  
900 - 885 WEST GEORGIA STREET,  
VANCOUVER, BRITISH COLUMBIA, V6C3H1

## TRADEMARK DETAILS

# DR.EVIDENCE

### Trademark Type

Standard Characters

### Services

#### Class 42

Providing online information to members-only for searching, retrieving, comparing, and contrasting information about pharmaceutical drug labels from a computer database or the Internet; providing search engines for the Internet using artificial intelligence for obtaining medical literature and data from journals and other publications on a global computer network exclusively to the members-only; hosting software as a service (saas) services featuring software using artificial intelligence for analyzing clinical trial data in the field of pharmaceutical drug research and development.

### Claims

Priority Filing Date: March 30, 2021, Country or Office: UNITED STATES OF AMERICA,  
Application No: 90612059 in association with the same kind of services



**Application Number** 2,154,454  
**International Registration Number** 1632894  
**Language of Application** English

**Filing Date** 2021-09-30

## APPLICANT DETAILS

**Applicant**  
Speira GmbH  
Aluminiumstraße 1  
41515 Grevenbroich  
GERMANY

## TRADEMARK DETAILS

# SOUL

**Trademark Type**  
Standard Characters

**Goods**

**Class 06**

Rolled sheets, bands, blanks of aluminium or aluminium alloys being semi-finished goods (precursors) for use by the manufacturing trade and industry.

**Application Number** 2,154,473  
**International Registration Number** 1632588  
**Language of Application** English

**Filing Date** 2021-10-06

## APPLICANT DETAILS

### Applicant

Innovia Films Limited  
Station Road  
Wigton, Cumbria CA7 9BG  
UNITED KINGDOM

## TRADEMARK DETAILS

# PROPANOTE.

### Trademark Type

Standard Characters

### Goods

#### Class 17

Films of plastic materials, namely, polymer films for use in commercial or industrial manufacturing of currency or security documents or devices.

**Application Number** 2,154,506  
**International Registration Number** 1632985  
**Language of Application** English

**Filing Date** 2021-10-14

## **APPLICANT DETAILS**

### **Applicant**

QUANZHOU BEST BAGS CO., LTD.  
Floor 4, Ruiyang Building,  
No. 737, Nanhuan Rd,  
Licheng District,  
Quanzhou City  
362212 Fujian Province  
CHINA

## **TRADEMARK DETAILS**

### **Trademark Type**

Design

### **Visual Representation**

# Mountain Land

### **Goods**

#### **Class 18**

Imitation leather; pocket wallets; travelling bags; bags, namely, sports bags; umbrellas; walking sticks; leather straps; trimmings of leather for furniture; harness fittings; small bags for men.

**Application Number** 2,154,556  
**International Registration Number** 1633336  
**Language of Application** English

**Filing Date** 2021-10-26

## APPLICANT AND AGENT DETAILS

### Applicant

Schultz Grimes Inc.  
340 S. Lemon Ave. #1922  
Walnut CA 91789  
UNITED STATES OF AMERICA

### Agent

OYEN WIGGS GREEN & MUTALA LLP  
480-THE STATION, 601 WEST CORDOVA  
STREET, VANCOUVER, BRITISH  
COLUMBIA, V6B1G1

## TRADEMARK DETAILS

# Heel That Pain

### Trademark Type

Standard Characters

### Goods

#### Class 25

Heel inserts.

**Application Number** 2,154,613  
**International Registration Number** 1633854  
**Language of Application** English

**Filing Date** 2021-11-05

## APPLICANT AND AGENT DETAILS

### Applicant

Shaun Chu  
110 Messinger Street  
Canton MA 02021  
UNITED STATES OF AMERICA

### Agent

CHANTAL ST. DENIS  
(O'BRIEN TM SERVICES INC), 262, chemin  
Eardley, Gatineau, QUEBEC, J9J2Y7

## TRADEMARK DETAILS

### Trademark Type

Design

### Visual Representation



### Trademark Description

The mark consists of a stylized "S" between two chevrons pointing left and right; the negative space between the chevrons and the "S" forms right facing and left facing arrows; color is not a feature of the mark.

### Goods

#### Class 09

(1) Computer software for control of differentials for land vehicles; computer software for control of differentials for radio-controlled toy vehicles; computer software for control of differentials for radio controlled model vehicles; computer software for control of differentials for toy drones.

#### Class 12

(2) Land vehicle parts, namely, high performance differentials; land vehicle parts, namely, heavy duty differentials; land vehicle parts, namely, electronic differentials; automotive components,

namely, high performance differentials; automotive components, namely, heavy duty differentials; automotive components, namely, electronic differentials; vehicle power train mechanism, namely, high performance differentials; vehicle power train mechanism, namely, heavy duty differentials; vehicle power train mechanism, namely, electronic differentials; land vehicle parts, namely, differentials and electronic differentials for performance and off-road vehicles.

**Class 28**

(3) Radio-controlled toy vehicles; radio controlled model vehicles; toy drones; parts for radio-controlled toy vehicles and toy drones, namely, differentials, axels, tires, and control units; parts for radio-controlled toy vehicles and toy drones, namely, electronic differentials, high performance differentials, and heavy-duty differentials; parts for radio controlled toy vehicles and toy drones, namely, electronic differential control modules.

**Claims**

Priority Filing Date: May 06, 2021, Country or Office: UNITED STATES OF AMERICA, Application No: 90694211 in association with the same kind of goods

**Application Number** 2,154,616  
**International Registration Number** 1632733  
**Language of Application** English

**Filing Date** 2021-11-07

## APPLICANT DETAILS

### Applicant

Dermaskill Inc.  
1968 S. Coast Hwy, #1513  
Laguna Beach CA 92651  
UNITED STATES OF AMERICA

## TRADEMARK DETAILS

# DERMASKILL

### Trademark Type

Standard Characters

### Goods

#### Class 03

Cosmetics; anti-aging moisturizer; anti-aging moisturizers used as cosmetics; beauty creams; beauty gels; beauty lotions; beauty masks; beauty milks; beauty serums; beauty soap; eye cream; eye lotions; face and body creams; face creams; night cream; non-medicated cosmetic soap; non-medicated skin care preparations; skin cleansers; skin cleansing cream; skin cleansing lotion; skin conditioners; skin cream; skin lighteners; skin lightening creams; skin lotion; skin masks; skin moisturizer; skin moisturizer masks; skin moisturizing gel; skin soap; skin toners; wrinkle removing skin care preparations; beauty care cosmetics; cosmetic creams for skin care; gel eye masks; natural cosmetics; non-medicated cosmetics; non-medicated skin creams; organic cosmetics.

**Application Number** 2,154,620  
**International Registration Number** 1633170  
**Language of Application** English

**Filing Date** 2021-11-08

## APPLICANT DETAILS

### Applicant

Cafe Spice, LLC  
677 Little Britain Road  
New Windsor NY 12553  
UNITED STATES OF AMERICA

## TRADEMARK DETAILS

# CAFE SPICE

### Trademark Type

Standard Characters

### Goods

#### Class 29

(1) Prepared and prepackaged meals, entrees and snacks consisting primarily of meat, poultry, vegetables and/or grains; Soups; Prepared and prepackaged meals and snacks consisting primarily of vegetables

#### Class 30

(2) Sandwiches; sandwiches, namely, sandwiches made with naan bread; vegetable fritters; samosas; burritos; quesadillas; cooked rice; combination meals consisting primarily of rice-based entrees

### Claims

Priority Filing Date: November 02, 2021, Country or Office: UNITED STATES OF AMERICA, Application No: 97104176 in association with the same kind of goods (2); November 02, 2021, Country or Office: UNITED STATES OF AMERICA, Application No: 97104170 in association with the same kind of goods (1)



**Application Number** 2,154,623  
**International Registration Number** 1632521  
**Language of Application** English

**Filing Date** 2021-11-08

## APPLICANT DETAILS

**Applicant**  
ORIGINCLEAR, INC.  
SUITE 200  
13575 58TH STREET NORTH  
CLEARWATER FL 33760-3739  
UNITED STATES OF AMERICA

## TRADEMARK DETAILS

**\$H20**

**Trademark Type**  
Standard Characters

**Goods**

**Class 09**

Downloadable computer software for managing cryptocurrency transactions using blockchain technology; downloadable computer software for managing and validating cryptocurrency transactions using blockchain-based smart contracts; downloadable computer software for managing and verifying cryptocurrency transactions on a blockchain; downloadable computer software for use as a cryptocurrency wallet; downloadable software for generating cryptographic keys for receiving and spending cryptocurrency.

**Application Number** 2,154,628  
**International Registration Number** 1632811  
**Language of Application** English

**Filing Date** 2021-11-09

## APPLICANT DETAILS

### Applicant

Alphyn Biologics, LLC  
3724 Thomas Point Road  
Annapolis MD 21403  
UNITED STATES OF AMERICA

## TRADEMARK DETAILS

### Trademark Type

Design

### Visual Representation



**ALPHYN**



---

B I O L O G I C S

**Trademark Description**

The mark consists of a drawing of an Alphyn with the words "Alphyn Biologics" beneath the drawing and in a stylized font. A horizontal line is between the words "Alphyn" and "Biologics".

**Disclaimer**

The right to the exclusive use of the word "BIOLOGICS" is disclaimed apart from the trademark.

**Services****Class 42**

Research and development of drugs and medicines for the treatment of infections, lung diseases, and skin diseases; research and development in the pharmaceutical, life sciences, and biomedicine fields; scientific research, testing, and analysis in the fields of pharmaceuticals, life science, and biomedicine; medical and scientific research on lung diseases, skin diseases, infections, and cancer; pharmaceutical products testing, analysis, research, and development.

**Application Number** 2,154,631  
**International Registration Number** 1633478  
**Language of Application** English

**Filing Date** 2021-11-10

## APPLICANT DETAILS

### Applicant

C & C Jewelry Mfg., Inc.  
323 West 8th Street,  
4th Floor  
Los Angeles CA 90014  
UNITED STATES OF AMERICA

## TRADEMARK DETAILS

### Trademark Type

Design

### Visual Representation



### Trademark Description

The mark consists of an image of a pear shaped diamond and a leaf, with line markings indicating facets of a diamond and veins of a leaf. The white color represents background and/or transparent areas and is not part of the mark.

### Goods

#### Class 14

Precious metal jewelry containing laboratory-grown diamonds.

### Claims

Priority Filing Date: May 13, 2021, Country or Office: UNITED STATES OF AMERICA, Application No: 90708869 in association with the same kind of goods

**Application Number** 2,154,632  
**International Registration Number** 1633476  
**Language of Application** English

**Filing Date** 2021-11-10

## APPLICANT DETAILS

### Applicant

Aterian Investment Management, LP  
8th Floor, 550 Fifth Avenue  
New York NY 10036  
UNITED STATES OF AMERICA

## TRADEMARK DETAILS

### Trademark Type

Design

### Visual Representation



### Trademark Description

The mark consists of two vertical, angled, converging lines, one longer than the other, next to the word ATERIAN with the words INVESTMENT PARTNERS below the word ATERIAN.

### Services

#### Class 36

Financial services, namely, investment management and private equity fund investment services.

### Claims

Priority Filing Date: May 12, 2021, Country or Office: UNITED STATES OF AMERICA, Application No: 90706033 in association with the same kind of services

**Application Number** 2,154,639  
**International Registration Number** 1633875  
**Language of Application** English

**Filing Date** 2021-11-10

## APPLICANT DETAILS

### Applicant

Get Together Inc.  
1748 Shattuck Avenue, No. 130  
Berkeley CA 94109  
UNITED STATES OF AMERICA

## TRADEMARK DETAILS

# DO MORE TOGETHER

### Trademark Type

Standard Characters

### Goods

#### Class 09

Downloadable mobile applications for social networking and calendaring.

### Services

#### Class 42

Providing temporary use of non-downloadable cloud-based software for social networking and calendaring.

### Claims

Priority Filing Date: May 13, 2021, Country or Office: UNITED STATES OF AMERICA, Application No: 90710024 in association with the same kind of goods and in association with the same kind of services

**Application Number** 2,154,642  
**International Registration Number** 1633481  
**Language of Application** English

**Filing Date** 2021-11-11

## APPLICANT DETAILS

### Applicant

Get Together Inc.  
1748 Shattuck Avenue, No. 130  
Berkeley CA 94109  
UNITED STATES OF AMERICA

## TRADEMARK DETAILS

### Trademark Type

Design

### Visual Representation



### Trademark Description

The mark consists of stylized letters "IRL".

### Goods

#### Class 09

Downloadable mobile application for social networking, calendaring, and planning.

### Services

#### Class 42

Providing temporary use of non-downloadable software for social networking, calendaring, and planning.

**Application Number** 2,154,661  
**International Registration Number** 1363209  
**Language of Application** English

**Filing Date** 2021-11-12

## APPLICANT DETAILS

**Applicant**  
Gerb Schwingungsisolierungen GmbH & Co. KG  
Roedernallee 174-176  
13407 Berlin  
GERMANY

## TRADEMARK DETAILS

# NOVODAMP

**Trademark Type**  
Standard Characters

### Goods

#### Class 17

Mats of synthetic vibration-damping elastomers and/or rubber-like materials for vibration damping on stationary objects or fixed objects.



**Application Number** 2,154,693  
**International Registration Number** 1633190  
**Language of Application** English

**Filing Date** 2021-11-16

## APPLICANT DETAILS

### Applicant

The Toro Company  
Legal Department,  
8111 Lyndale Avenue South  
Bloomington MN 55420  
UNITED STATES OF AMERICA

## TRADEMARK DETAILS

# CLIMATE LOGIC

### Trademark Type

Standard Characters

### Goods

#### Class 09

Electronic devices for controlling automatic irrigation systems, namely, weather sensors and controllers that automatically send and receive weather data and adjust irrigation schedules accordingly.

**Application Number** 2,154,696  
**International Registration Number** 1633895  
**Language of Application** English

**Filing Date** 2021-11-16

## **APPLICANT DETAILS**

### **Applicant**

Bain & Company Inc.; SATMETRIX SYSTEMS,  
INC.; FRED REICHHELD  
131 Dartmouth Street  
Boston MA 02116  
UNITED STATES OF AMERICA

## **TRADEMARK DETAILS**

# **NET PROMOTER**

### **Trademark Type**

Standard Characters

### **Services**

#### **Class 35**

Business marketing consulting services; market research services; conducting business, customer satisfaction, customer loyalty and market research surveys.

**Application Number** 2,154,697  
**International Registration Number** 1633573  
**Language of Application** English

**Filing Date** 2021-11-17

## APPLICANT DETAILS

### Applicant

Merit Medical Systems, Inc.  
1600 West Merit Parkway  
South Jordan UT 84095  
UNITED STATES OF AMERICA

## TRADEMARK DETAILS

# ROADSTER

### Trademark Type

Standard Characters

### Goods

#### Class 10

Medical products, namely, vascular sheaths.

### Claims

Priority Filing Date: May 18, 2021, Country or Office: UNITED STATES OF AMERICA, Application No: 90719859 in association with the same kind of goods

**Application Number** 2,154,704  
**International Registration Number** 1633202  
**Language of Application** English

**Filing Date** 2021-11-17

## APPLICANT AND AGENT DETAILS

### Applicant

BIOHAVEN PHARMACEUTICAL IRELAND  
DAC  
Operations Supports Group  
Ringaskiddy, County Cork  
IRELAND

### Agent

SMART & BIGGAR LP  
1000 RUE DE LA GAUCHETIERE OUEST,  
BUREAU 3300, MONTREAL, QUEBEC,  
H3B4W5

## TRADEMARK DETAILS

# DISSOLVING THE LINE BETWEEN ACUTE AND PREVENTATIVE TREATMENT

### Trademark Type

Standard Characters

### Goods

#### Class 05

(1) Pharmaceutical preparations for the treatment of headache and facial pain.

#### Class 16

(2) Printed publications in the nature of brochures, pamphlets, and written articles for medical information and patient support in the field of headache and facial pain.

### Services

#### Class 41

Providing online educational information in the academic field of headaches and facial pain.

### Claims

Priority Filing Date: May 19, 2021, Country or Office: UNITED STATES OF AMERICA, Application No: 90721863 in association with the same kind of goods and in association with the same kind of services

**Application Number** 2,154,705  
**International Registration Number** 1633201  
**Language of Application** English

**Filing Date** 2021-11-17

## APPLICANT DETAILS

### Applicant

Merit Medical Systems, Inc.  
1600 West Merit Parkway  
South Jordan UT 84095  
UNITED STATES OF AMERICA

## TRADEMARK DETAILS

# SPLASHWIRE

### Trademark Type

Standard Characters

### Goods

#### Class 10

Medical devices, namely, guidewires.

### Claims

Priority Filing Date: May 18, 2021, Country or Office: UNITED STATES OF AMERICA, Application No: 90719419 in association with the same kind of goods

**Application Number** 2,154,708  
**International Registration Number** 1632961  
**Language of Application** English

**Filing Date** 2021-11-17

## **APPLICANT DETAILS**

### **Applicant**

Archer-Daniels-Midland Company  
4666 Faries Parkway  
Decatur IL 62526  
UNITED STATES OF AMERICA

## **TRADEMARK DETAILS**

# **KNWBLE GRWN**

### **Trademark Type**

Standard Characters

### **Goods**

#### **Class 29**

Edible oils.

### **Claims**

Priority Filing Date: November 02, 2021, Country or Office: UNITED STATES OF AMERICA,  
Application No: 97103896 in association with the same kind of goods

**Application Number** 2,154,719  
**International Registration Number** 1633351  
**Language of Application** English

**Filing Date** 2021-11-18

## APPLICANT DETAILS

### Applicant

Andritz Inc.  
5405 Windward Parkway, Suite 100W  
Alpharetta GA 30004  
UNITED STATES OF AMERICA

## TRADEMARK DETAILS

# DURAFAB

### Trademark Type

Standard Characters

### Goods

#### Class 07

Machine parts, namely, refiner plates for pulp refiner machines and fiber refining machines.

### Claims

Priority Filing Date: May 19, 2021, Country or Office: UNITED STATES OF AMERICA, Application No: 90721314 in association with the same kind of goods

**Application Number** 2,154,726  
**International Registration Number** 1616992  
**Language of Application** English

**Filing Date** 2021-11-18

## APPLICANT DETAILS

**Applicant**  
CELLTRION, INC.  
23, Academy-ro,  
Yeonsu-gu  
Incheon  
REPUBLIC OF KOREA

## TRADEMARK DETAILS

**SKYDELT**

**Trademark Type**  
Standard Characters

**Goods**

**Class 05**

Ophthalmic preparations; pharmaceutical preparations for the treatment of angiogenesis.



**Application Number** 2,154,727  
**International Registration Number** 1632964  
**Language of Application** English

**Filing Date** 2021-11-18

## APPLICANT DETAILS

### Applicant

Andritz Inc.  
5405 Windward Parkway, Suite 100W  
Alpharetta GA 30004  
UNITED STATES OF AMERICA

## TRADEMARK DETAILS

# DURABOND

### Trademark Type

Standard Characters

### Goods

#### Class 07

Machine parts, namely, refiner plates for pulp refiner machines and fiber refining machines.

### Claims

Priority Filing Date: May 19, 2021, Country or Office: UNITED STATES OF AMERICA, Application No: 90721319 in association with the same kind of goods

**Application Number** 2,154,728  
**International Registration Number** 1632889  
**Language of Application** English

**Filing Date** 2021-11-18

## **APPLICANT DETAILS**

### **Applicant**

Planting Hope Brands, LLC  
4517 N. Clark Street  
Chicago IL 60640  
UNITED STATES OF AMERICA

## **TRADEMARK DETAILS**

# **PLANTACADABRA**

### **Trademark Type**

Standard Characters

### **Goods**

#### **Class 29**

Plant-based dips and spreads.

**Application Number** 2,154,729  
**International Registration Number** 1632876  
**Language of Application** English

**Filing Date** 2021-11-18

## APPLICANT DETAILS

### Applicant

Andritz Inc.  
5405 Windward Parkway, Suite 100W  
Alpharetta GA 30004  
UNITED STATES OF AMERICA

## TRADEMARK DETAILS

# DURACAST

### Trademark Type

Standard Characters

### Goods

#### Class 07

Machine parts, namely, refiner plates for pulp refiner machines and fiber refining machines.

### Claims

Priority Filing Date: May 19, 2021, Country or Office: UNITED STATES OF AMERICA, Application No: 90721294 in association with the same kind of goods

**Application Number** 2,154,733  
**International Registration Number** 1633496  
**Language of Application** English

**Filing Date** 2021-11-19

## APPLICANT AND AGENT DETAILS

### Applicant

Compass Mining, Inc.  
78 SW 7th Street, Suite 500  
Miami FL 33130  
UNITED STATES OF AMERICA

### Agent

MLT AIKINS LLP  
2100 Livingston Place, 222-3rd Avenue SW,  
Calgary, ALBERTA, T2P0B4

## TRADEMARK DETAILS

# COMPASS MINING

### Trademark Type

Standard Characters

### Goods

#### Class 09

Computer hardware; computer hardware for data mining; computer hardware for virtual currency mining.

### Claims

Priority Filing Date: May 24, 2021, Country or Office: UNITED STATES OF AMERICA, Application No: 90730441 in association with the same kind of goods

**Application Number** 2,154,734  
**International Registration Number** 1633219  
**Language of Application** English

**Filing Date** 2021-11-19

## APPLICANT DETAILS

**Applicant**  
MATRIX SERVICE COMPANY  
5100 East Skelly Drive, Suite 700  
Tulsa OK 74135  
UNITED STATES OF AMERICA

## TRADEMARK DETAILS

# FLOWDOME

**Trademark Type**  
Standard Characters

### Services

#### Class 40

Custom manufacture of metal roofing, metal roofs for storage tanks, and aluminum geodesic domes.

### Claims

Priority Filing Date: June 01, 2021, Country or Office: UNITED STATES OF AMERICA, Application No: 90747446 in association with the same kind of services

**Application Number** 2,154,739  
**International Registration Number** 1633210  
**Language of Application** English

**Filing Date** 2021-11-19

## APPLICANT DETAILS

### Applicant

Outset Medical, Inc.  
3052 Orchard Drive  
San Jose CA 95134  
UNITED STATES OF AMERICA

## TRADEMARK DETAILS

# OUTSET

### Trademark Type

Standard Characters

### Services

#### Class 42

Design and development of medical technology and software in the field of dialysis.

### Claims

Priority Filing Date: May 19, 2021, Country or Office: UNITED STATES OF AMERICA, Application No: 90721503 in association with the same kind of services

**Application Number** 2,154,746  
**International Registration Number** 1608358  
**Language of Application** English

**Filing Date** 2021-11-22

## APPLICANT DETAILS

### Applicant

CYTIVA BIOPROCESS R&D AB  
BJORKGATAN 30  
SE-751 84 UPPSALA  
SWEDEN

## TRADEMARK DETAILS

# HISCREEN FIBRO

### Trademark Type

Standard Characters

### Goods

#### Class 09

Chromatography apparatus for laboratory and scientific use, namely, pre-packed apparatus for use in separation and purification of biomolecules.

### Claims

Priority Filing Date: May 27, 2021, Country or Office: UNITED STATES OF AMERICA, Application No: 90740009 in association with the same kind of goods

**Application Number** 2,154,748  
**International Registration Number** 1420858  
**Language of Application** English

**Filing Date** 2021-11-22

## APPLICANT DETAILS

**Applicant**  
VIAHART, LLC  
1321 Upland Drive, #6481  
Houston, TX 77043  
UNITED STATES OF AMERICA

## TRADEMARK DETAILS

# Brain Flakes

**Trademark Type**  
Standard Characters

### Goods

#### Class 28

Children's educational toys for developing fine motor skills and engineering skills; construction toys; stacking toys; toy building blocks; toy building blocks capable of interconnection; toy construction sets.



**Application Number** 2,154,749  
**International Registration Number** 1360318  
**Language of Application** English

**Filing Date** 2021-11-22

## APPLICANT DETAILS

### Applicant

Minaris Medical Co., Ltd.  
8-10, Harumi 1-chome,  
Chuo-ku  
Tokyo 104-6004  
JAPAN

## TRADEMARK DETAILS

# MedFrontier

### Trademark Type

Standard Characters

### Goods

#### Class 01

(1) In vitro diagnostic reagents for scientific purposes; diagnostic reagents for medical-scientific research use.

#### Class 05

(2) Diagnostic reagents for medical purposes; in vitro diagnostic preparations for medical purposes.

**Application Number** 2,154,759  
**International Registration Number** 1469315  
**Language of Application** English

**Filing Date** 2021-11-25

## APPLICANT DETAILS

### Applicant

YIWU MUGUO BAGS CO., LTD.  
5TH FLOOR, 59TH DONGQING ROAD,  
FUTIAN STREET, YIWU CITY,  
JINHUA CITY  
100121 ZHEJIANG PROVINCE  
CHINA

## TRADEMARK DETAILS

### Trademark Type

Design

### Visual Representation

OKTA

### Goods

#### Class 18

Randsels [Japanese school satchels]; haversacks; travelling trunks; pocket wallets; leather, unworked or semi-worked; mountaineering sticks; rucksacks; school satchels; briefcases; handbags.

**Application Number** 2,155,860  
**Language of Application** English

**Filing Date** 2021-12-22

## APPLICANT AND AGENT DETAILS

### Applicant

Reckitt Benckiser (Canada) Inc.  
1680 Tech Avenue  
Unit 2  
Mississauga  
ONTARIO  
L4W5S9

### Agent

SMART & BIGGAR LP  
SUITE 900, 55 METCALFE STREET, P.O.  
BOX 2999, STATION D, OTTAWA, ONTARIO,  
K1P5Y6

## TRADEMARK DETAILS

**Trademark Type**

Design

**Visual Representation**



**Goods****Class 03**

(1) All-purpose cleaners for household, commercial, industrial and institutional use; all-purpose cleaning preparations; cleaning preparations for toilets, bathrooms, kitchens and floors; disposable wipes and cloths impregnated with cleaning compounds for use on hard surfaces; disposable wipes and cloths impregnated with cleaning compounds for cleaning; antibacterial soaps; soaps for personal use; hand cleaning preparations; hand soaps; liquid soaps for hands, face and body; non-medicated skin care preparations in the nature of barrier creams, lotions and gels for the skin; laundry detergents; dishwashing detergents; all-purpose stain removers for household use, fabric stain removers and laundry stain removers; cleaning preparations for cleaning washing machines and dishwashing machines; scented fabric refresher sprays

**Class 05**

(2) All-purpose disinfecting preparations for household, commercial and industrial use, namely all-purpose disinfectants; all-purpose deodorizing preparations for household, commercial and industrial use, namely air deodorizing preparations; all-purpose germicides and bactericides; all-purpose disinfectants for toilets, kitchens, floors and bathrooms; hard surface sanitizing preparations; deodorants for textiles; antibacterial handwash; sanitizing preparations for household, commercial and industrial use, namely all-purpose sanitizers, sanitizing wipes, surface sanitizing preparations; liquid sanitizers for laundry use; disposable wipes and cloths impregnated with a disinfectant for use on hard surfaces; indoor air sanitizing preparations; air disinfecting preparations; air purifying preparations

**Class 11**

(3) Ultraviolet sterilisers, namely ultraviolet (UV) lamps for use in disinfecting surfaces, ultraviolet (UV) germicidal lamps and parts and fittings for all the aforesaid goods sold as a unit therewith; dispensing units for disinfecting and sanitizing solutions, namely, all-purpose disinfectants, all-

purpose sanitizers, sanitizing wipes, surface sanitizing preparations and parts and fittings for all the aforesaid goods sold as a unit therewith; air deodorising apparatus, namely electric room deodorizing units and parts and fittings for all the aforesaid goods sold as a unit therewith; air disinfecting apparatus, namely air cleaning units, household air cleaners and parts and fittings for all the aforesaid goods sold as a unit therewith; air filtration apparatus, namely air filtering units for removing dust, smoke and allergens from the air and parts and fittings for all the aforesaid goods sold as a unit therewith; air purifying apparatus, namely air purifying units and parts and fittings for all the aforesaid goods sold as a unit therewith; electrical devices for the neutralisation, reduction and control of allergens, namely air purifiers for household use, air purifying units for commercial use, air purifying units for industrial purposes and parts and fittings for all the aforesaid goods sold as a unit therewith

**Class 21**

(4) Dispensers for liquid soap; soap dispensers; non-electric floor sweepers; mops; dispensers for all-purpose cleaning preparations; dispensers for disposable wipes; disinfectant and sanitizing apparatus, for household, commercial, industrial and institutional use, namely, dispensers for disinfecting and sanitizing solutions

**Services****Class 41**

Educational services in the nature of online and in-person classes, webinars and training in the field of hygiene, public health, sanitation, and protection against germs and viruses; educational services in the nature of online and in-person classes, webinars and training in the field of provision, promotion, sourcing, ordering and appraisal of products and services related to hygiene, public health, sanitation, and protection against germs and viruses; organising and conducting conferences, seminars, educational exhibitions, trainings, demonstrations and discussion groups in the field of hygiene, public health, sanitation and protection against germs and viruses; providing educational and instructional information and materials in-person, online or via a website in the field of hygiene, public health, sanitation and protection against germs and viruses

**Application Number** 2,155,926  
**International Registration Number** 1634879  
**Language of Application** English

**Filing Date** 2021-04-30

## APPLICANT DETAILS

**Applicant**  
DEWULF NV  
Moorseelsesteenweg 20  
B-8800 Roeselare  
BELGIUM

## TRADEMARK DETAILS

# Dewulf

**Trademark Type**  
Standard Characters

### Goods

#### Class 07

(1) Machines and machine tools for agriculture, namely agricultural harvesting machines.

#### Class 12

(2) Agricultural vehicles, namely tractors for agricultural purposes.

### Services

#### Class 35

Mediation of trade business for third parties, import-export agencies in the field of machines, machine tools and agricultural vehicles; advertising and publicity in the field of machines and machine tools for the agricultural industry and agricultural vehicles; providing business information pertaining the procurement, buying, selling and tendering information and opportunities relating to machines and machine tools for agricultural purposes and agricultural vehicles via the internet.

**Application Number** 2,155,941  
**International Registration Number** 1635332  
**Language of Application** English

**Filing Date** 2021-06-03

## APPLICANT AND AGENT DETAILS

### Applicant

Boundless Robotics, Inc.  
PO BOX 290301  
Charlestown MA 02129  
UNITED STATES OF AMERICA

### Agent

RICHES, MCKENZIE & HERBERT LLP  
SUITE 1800, 2 BLOOR STREET EAST,  
TORONTO, ONTARIO, M4W3J5

## TRADEMARK DETAILS

# annaboto

### Trademark Type

Standard Characters

### Goods

#### Class 21

Hydroponic garden kit for home use comprising growing containers and also including hydroponic fertilizers, seeds, substrate, drain components, a book and starting class of DVD and CD instructional materials.

### Claims

Priority Filing Date: December 03, 2020, Country or Office: UNITED STATES OF AMERICA,  
Application No: 90356373 in association with the same kind of goods

**Application Number** 2,155,976  
**International Registration Number** 1635334  
**Language of Application** English

**Filing Date** 2021-07-09

## APPLICANT AND AGENT DETAILS

### Applicant

Harpo, Inc.  
1041 N Formosa Avenue  
West Hollywood CA 90046  
UNITED STATES OF AMERICA

### Agent

BERESKIN & PARR LLP/S.E.N.C.R.L., S.R.L.  
SCOTIA PLAZA, 40 KING STREET WEST,  
40th FLOOR, TORONTO, ONTARIO, M5H3Y2

## TRADEMARK DETAILS

# THE ME YOU CAN'T SEE

### Trademark Type

Standard Characters

### Goods

#### Class 09

Downloadable fiction e-books on a variety of topics; downloadable non-fiction e-books on a variety of topics; downloadable mobile application software for viewing and sharing content featuring interviews, current events, and general human interest; digital media, namely, downloadable videos featuring interviews, current events, and general human interest.

### Claims

Priority Filing Date: January 14, 2021, Country or Office: UNITED STATES OF AMERICA,  
Application No: 90467599 in association with the same kind of goods



**Application Number** 2,156,008  
**International Registration Number** 1634933  
**Language of Application** English

**Filing Date** 2021-08-10

## APPLICANT DETAILS

### Applicant

Deks Industries Pty Ltd  
5/841 Mountain Highway  
BAYSWATER VIC 3153  
AUSTRALIA

## TRADEMARK DETAILS

# TRUE BLUE

### Trademark Type

Standard Characters

### Goods

#### Class 17

Rubber roofing seal washers for sealing between roofing screws and roofing sheets.

### Claims

Priority Filing Date: April 28, 2021, Country or Office: AUSTRALIA, Application No: 2174274 in association with the same kind of goods

Application Number 2,156,071  
International Registration Number 1634125  
Language of Application English

Filing Date 2021-09-28

## APPLICANT DETAILS

**Applicant**  
Kikkawa Jozo Co., Ltd.  
681 Godo,  
Isehara-shi  
Kanagawa 259-1138  
JAPAN

## TRADEMARK DETAILS

**Trademark Type**  
Design

**Visual Representation**



**Trademark Description**

The mark consists of the two stylized Japanese kanji characters in order from upper right to lower left.

**Foreign Character Translation**

The translation provided by the applicant of the Japanese word AFURI is RAINFALL.

**Foreign Character Transliteration**

The transliteration provided by the applicant of the Japanese characters is AFURI.

**Goods****Class 33**

Sake; Japanese sake [nihonshu]; shochu [Japanese barley-based white liquor]; shochu [Japanese sweet potato-based distilled spirit]; Japanese sweet rice-based mixed liquor [shiro-zake]; naoshi [Japanese liquor]; Japanese shochu-based mixed liquor [mirin]; whisky; vodka; gin; brandy; rum; wine; liqueurs; alcoholic fruit beverages; Japanese shochu-based beverages [chuhai]; wujiapie-jiou [Chinese wheat-based liquor]; baiganr [Chinese rice-based white liquor]; laojiou [Chinese sorghum-based brewed liquor]; flavored tonic liqueurs; Japanese liquor flavoured with Asian plum extracts; Japanese liquor containing herb extracts.

**Application Number** 2,156,108  
**International Registration Number** 1634466  
**Language of Application** English

**Filing Date** 2021-10-14

## APPLICANT AND AGENT DETAILS

### Applicant

Glaxo Group Limited  
980 Great West Road  
BRENTFORD, Middlesex TW8 9GS  
UNITED KINGDOM

### Agent

BORDEN LADNER GERVAIS LLP  
World Exchange Plaza, 100 Queen Street,  
Suite 1300, Ottawa, ONTARIO, K1P1J9

## TRADEMARK DETAILS

# IQROSMA

### Trademark Type

Standard Characters

### Goods

#### Class 05

Pharmaceutical preparations for use as anti-infectives; pharmaceutical preparations for the treatment of viral conditions, namely human immunodeficiency virus (HIV), human papilloma virus, respiratory syncytial virus, hepatitis, herpes genitalis, herpes labialis, herpes simplex virus, varicella-zoster virus, Epstein-Barr virus and cytomegalovirus; pharmaceutical preparations for the treatment and prevention of respiratory diseases and disorders and their symptoms; pharmaceutical preparations for the treatment of immune system related diseases and disorders, namely immunosuppressants; pharmaceutical preparations for the treatment of immunologic diseases and disorders namely, autoimmune diseases and disorders; pharmaceutical preparations for the treatment of atherosclerosis; pharmaceutical preparations for the treatment of viral conditions namely human immunodeficiency virus (HIV), HPV, RSV, hepatitis, herpes genitalis, herpes labialis, herpes simplex virus, varicella-zoster virus, Epstein-Barr virus and cytomegalovirus; pharmaceutical preparations for the treatment and prevention of metabolic related diseases and disorders namely disorders of the endocrine system, namely growth and thyroid disorders, diabetes, metabolic syndrome, obesity, weight loss and weight management; pharmaceutical preparations for the treatment and prevention of cardiovascular, cardiopulmonary, cardio-renal and renal diseases and disorders; pharmaceutical preparations for the prevention and treatment of oncological diseases and disorders; pharmaceutical preparations for the treatment of inflammation and inflammatory related diseases and disorders namely arthritis, rheumatoid arthritis, inflammatory bowel diseases, inflammatory connective tissue diseases, vasculitis, synovitis; pharmaceutical preparations for the prevention and treatment of sequelae of oncologic diseases and their treatment namely nausea and vomiting, hematologic depression, mucositis, cachexia, pain, bone pain and fatigue; pharmaceutical preparations for the treatment of blood-related diseases and disorders namely thrombocytopenia, coagulation disorders, bleeding disorders, platelet disorders, blood vessel disorders, sickle-cell disease and its related disorders, anemias, sepsis and infections in and of the blood; pharmaceutical preparations for the treatment of musculoskeletal diseases, disorders and injuries namely connective tissue diseases, bone diseases, osteoporosis, spinal diseases, back pain, gout, fractures, sprains, sports injuries,

osteogenesis imperfecta, muscle wasting (cachexia), renal osteodystrophy, cartilage injuries, joint replacement and osteoarthritis; pharmaceutical preparations for use in ophthalmology; pharmaceutical preparations for the treatment of dermatological diseases and disorders namely dermatitis, skin and skin structure infections namely bacterial skin infections, fungal skin infections, viral skin infections and parasitic skin infections, psoriasis, eczema and sexually transmitted diseases; pharmaceutical preparations for the treatment of hormonal related diseases and disorders namely hypogonadism, testosterone/androgen disorders and estrogen disorders; pharmaceutical preparations for the treatment of gastrointestinal related diseases and disorders namely irritable bowel disorders and symptoms, digestive disorders and acid-related disorders; pharmaceutical preparations for the treatment of sexual dysfunction namely erectile dysfunction, male and female sexual dysfunction disorders namely arousal disorder, pain disorder, desire disorder and orgasm disorder; pharmaceutical preparations for the treatment of genitourinary diseases namely urological diseases and disorders; pharmaceutical preparations for the treatment of gynaecological diseases and disorders namely amenorrhoea, dysmenorrhoea and infertility; pharmaceutical hormonal preparations namely corticosteroids, hormone replacement therapy preparations, oral contraceptives, thyroid hormone preparations; pharmaceutical preparations for the treatment of incontinence, prostate diseases and disorders, bladder diseases and disorders; pharmaceutical preparations for the treatment of sexually transmitted diseases, inflammatory pelvic diseases, vasomotor/menopausal symptoms, endometriosis/uterine fibroids, Leiomyoma, endourology/stone, pre-eclampsia and pre-term labour; pharmaceutical preparations for the treatment of prostatitis, nephritis, cystitis, vaginitis, renal disease; pharmaceutical preparations for the treatment of premenstrual dysphoric disorder, premenstrual syndrome, male hypogonadism and hormonal disorders namely polycystic ovary syndrome; pharmaceutical preparations for the treatment of hepatological related diseases namely hepatitis, non-alcoholic fatty liver disease (NAFLD), non-alcoholic steatohepatitis (NASH), liver fibroids, and cirrhosis; pharmaceutical preparations for the treatment of alopecia and androgenic alopecia (male pattern baldness); pharmaceutical preparations for the treatment of psychiatric diseases and disorders namely mood disorders, anxiety disorders, cognitive disorders, schizophrenia, and psychoses; pharmaceutical preparations for the treatment of damaged skin and tissue namely bee stings, sunburn, rashes, sores, corns, calluses and acne; pharmaceutical preparations for the treatment of inflammatory connective tissue diseases and injuries; pharmaceutical preparations for the treatment of malaria; pharmaceutical preparations for the treatment of tuberculosis; allergy medications; vaccines, namely prophylactic and therapeutic vaccines for humans; pharmaceutical preparations for the treatment of neurological diseases and disorders namely Parkinsons disease, Alzheimers disease, Huntingtons disease, dementia, migraine, cerebral palsy, brain injury, spinal cord injury, seizure disorders, epilepsy, restless legs syndrome, pain, neuropathic pain, inflammatory-related pain, fibromyalgia, stroke, multiple sclerosis, insomnia; pharmaceutical preparations for the treatment of central nervous system diseases and disorders namely central nervous system infections, brain diseases, central nervous system movement disorders, ocular motility disorders, spinal cord diseases, depression and anxiety and their related disorders namely schizophrenia and psychoses; pharmaceutical preparations for the treatment of muscular dystrophy.

### Claims

Priority Filing Date: August 12, 2021, Country or Office: UNITED KINGDOM, Application No: UK00003680675 in association with the same kind of goods

**Application Number** 2,156,109  
**International Registration Number** 1634465  
**Language of Application** English

**Filing Date** 2021-10-14

## APPLICANT AND AGENT DETAILS

### Applicant

Glaxo Group Limited  
980 Great West Road  
BRENTFORD, Middlesex TW8 9GS  
UNITED KINGDOM

### Agent

BORDEN LADNER GERVAIS LLP  
World Exchange Plaza, 100 Queen Street,  
Suite 1300, Ottawa, ONTARIO, K1P1J9

## TRADEMARK DETAILS

# OMTEKNI

### Trademark Type

Standard Characters

### Goods

#### Class 05

Pharmaceutical preparations for use as anti-infectives; pharmaceutical preparations for the treatment of viral conditions, namely human immunodeficiency virus (HIV), human papilloma virus, respiratory syncytial virus, hepatitis, herpes genitalis, herpes labialis, herpes simplex virus, varicella-zoster virus, Epstein-Barr virus and cytomegalovirus; pharmaceutical preparations for the treatment and prevention of respiratory diseases and disorders and their symptoms; pharmaceutical preparations for the treatment of immune system related diseases and disorders, namely immunosuppressants; pharmaceutical preparations for the treatment of immunologic diseases and disorders namely, autoimmune diseases and disorders; pharmaceutical preparations for the treatment of atherosclerosis; pharmaceutical preparations for the treatment of viral conditions namely human immunodeficiency virus (HIV), HPV, RSV, hepatitis, herpes genitalis, herpes labialis, herpes simplex virus, varicella-zoster virus, Epstein-Barr virus and cytomegalovirus; pharmaceutical preparations for the treatment and prevention of metabolic related diseases and disorders namely disorders of the endocrine system, namely growth and thyroid disorders, diabetes, metabolic syndrome, obesity, weight loss and weight management; pharmaceutical preparations for the treatment and prevention of cardiovascular, cardiopulmonary, cardio-renal and renal diseases and disorders; pharmaceutical preparations for the prevention and treatment of oncological diseases and disorders; pharmaceutical preparations for the treatment of inflammation and inflammatory related diseases and disorders namely arthritis, rheumatoid arthritis, inflammatory bowel diseases, inflammatory connective tissue diseases, vasculitis, synovitis; pharmaceutical preparations for the prevention and treatment of sequelae of oncologic diseases and their treatment namely nausea and vomiting, hematologic depression, mucositis, cachexia, pain, bone pain and fatigue; pharmaceutical preparations for the treatment of blood-related diseases and disorders namely thrombocytopenia, coagulation disorders, bleeding disorders, platelet disorders, blood vessel disorders, sickle-cell disease and its related disorders, anemias, sepsis and infections in and of the blood; pharmaceutical preparations for the treatment of musculoskeletal diseases, disorders and injuries namely connective tissue diseases, bone diseases, osteoporosis, spinal diseases, back pain, gout, fractures, sprains, sports injuries,

osteogenesis imperfecta, muscle wasting (cachexia), renal osteodystrophy, cartilage injuries, joint replacement and osteoarthritis; pharmaceutical preparations for use in ophthalmology; pharmaceutical preparations for the treatment of dermatological diseases and disorders namely dermatitis, skin and skin structure infections namely bacterial skin infections, fungal skin infections, viral skin infections and parasitic skin infections, psoriasis, eczema and sexually transmitted diseases; pharmaceutical preparations for the treatment of hormonal related diseases and disorders namely hypogonadism, testosterone/androgen disorders and estrogen disorders; pharmaceutical preparations for the treatment of gastrointestinal related diseases and disorders namely irritable bowel disorders and symptoms, digestive disorders and acid-related disorders; pharmaceutical preparations for the treatment of sexual dysfunction namely erectile dysfunction, male and female sexual dysfunction disorders namely arousal disorder, pain disorder, desire disorder and orgasm disorder; pharmaceutical preparations for the treatment of genitourinary diseases namely urological diseases and disorders; pharmaceutical preparations for the treatment of gynaecological diseases and disorders namely amenorrhoea, dysmenorrhoea and infertility; pharmaceutical hormonal preparations namely corticosteroids, hormone replacement therapy preparations, oral contraceptives, thyroid hormone preparations; pharmaceutical preparations for the treatment of incontinence, prostate diseases and disorders, bladder diseases and disorders; pharmaceutical preparations for the treatment of sexually transmitted diseases, inflammatory pelvic diseases, vasomotor/menopausal symptoms, endometriosis/uterine fibroids, Leiomyoma, endourology/stone, pre-eclampsia and pre-term labour; pharmaceutical preparations for the treatment of prostatitis, nephritis, cystitis, vaginitis, renal disease; pharmaceutical preparations for the treatment of premenstrual dysphoric disorder, premenstrual syndrome, male hypogonadism and hormonal disorders namely polycystic ovary syndrome; pharmaceutical preparations for the treatment of hepatological related diseases namely hepatitis, non-alcoholic fatty liver disease (NAFLD), non-alcoholic steatohepatitis (NASH), liver fibroids, and cirrhosis; pharmaceutical preparations for the treatment of alopecia and androgenic alopecia (male pattern baldness); pharmaceutical preparations for the treatment of psychiatric diseases and disorders namely mood disorders, anxiety disorders, cognitive disorders, schizophrenia, and psychoses; pharmaceutical preparations for the treatment of damaged skin and tissue namely bee stings, sunburn, rashes, sores, corns, calluses and acne; pharmaceutical preparations for the treatment of inflammatory connective tissue diseases and injuries; pharmaceutical preparations for the treatment of malaria; pharmaceutical preparations for the treatment of tuberculosis; allergy medications; vaccines, namely prophylactic and therapeutic vaccines for humans; pharmaceutical preparations for the treatment of neurological diseases and disorders namely Parkinsons disease, Alzheimers disease, Huntingtons disease, dementia, migraine, cerebral palsy, brain injury, spinal cord injury, seizure disorders, epilepsy, restless legs syndrome, pain, neuropathic pain, inflammatory-related pain, fibromyalgia, stroke, multiple sclerosis, insomnia; pharmaceutical preparations for the treatment of central nervous system diseases and disorders namely central nervous system infections, brain diseases, central nervous system movement disorders, ocular motility disorders, spinal cord diseases, depression and anxiety and their related disorders namely schizophrenia and psychoses; pharmaceutical preparations for the treatment of muscular dystrophy.

### Claims

Priority Filing Date: August 12, 2021, Country or Office: UNITED KINGDOM, Application No: UK00003680693 in association with the same kind of goods

**Application Number** 2,156,114  
**International Registration Number** 1634460  
**Language of Application** English

**Filing Date** 2021-10-14

## APPLICANT AND AGENT DETAILS

### Applicant

Glaxo Group Limited  
 980 Great West Road  
 BRENTFORD, Middlesex TW8 9GS  
 UNITED KINGDOM

### Agent

BORDEN LADNER GERVAIS LLP  
 World Exchange Plaza, 100 Queen Street,  
 Suite 1300, Ottawa, ONTARIO, K1P1J9

## TRADEMARK DETAILS

# QOSISDI

### Trademark Type

Standard Characters

### Goods

#### Class 05

Pharmaceutical preparations for use as anti-infectives; pharmaceutical preparations for the treatment of viral conditions, namely human immunodeficiency virus (HIV), human papilloma virus, respiratory syncytial virus, hepatitis, herpes genitalis, herpes labialis, herpes simplex virus, varicella-zoster virus, Epstein-Barr virus and cytomegalovirus; pharmaceutical preparations for the treatment and prevention of respiratory diseases and disorders and their symptoms; pharmaceutical preparations for the treatment of immune system related diseases and disorders, namely immunosuppressants; pharmaceutical preparations for the treatment of immunologic diseases and disorders namely, autoimmune diseases and disorders; pharmaceutical preparations for the treatment of atherosclerosis; pharmaceutical preparations for the treatment of viral conditions namely human immunodeficiency virus (HIV), HPV, RSV, hepatitis, herpes genitalis, herpes labialis, herpes simplex virus, varicella-zoster virus, Epstein-Barr virus and cytomegalovirus; pharmaceutical preparations for the treatment and prevention of metabolic related diseases and disorders namely disorders of the endocrine system, namely growth and thyroid disorders, diabetes, metabolic syndrome, obesity, weight loss and weight management; pharmaceutical preparations for the treatment and prevention of cardiovascular, cardiopulmonary, cardio-renal and renal diseases and disorders; pharmaceutical preparations for the prevention and treatment of oncological diseases and disorders; pharmaceutical preparations for the treatment of inflammation and inflammatory related diseases and disorders namely arthritis, rheumatoid arthritis, inflammatory bowel diseases, inflammatory connective tissue diseases, vasculitis, synovitis; pharmaceutical preparations for the prevention and treatment of sequelae of oncologic diseases and their treatment namely nausea and vomiting, hematologic depression, mucositis, cachexia, pain, bone pain and fatigue; pharmaceutical preparations for the treatment of blood-related diseases and disorders namely thrombocytopenia, coagulation disorders, bleeding disorders, platelet disorders, blood vessel disorders, sickle-cell disease and its related disorders, anemias, sepsis and infections in and of the blood; pharmaceutical preparations for the treatment of musculoskeletal diseases, disorders and injuries namely connective tissue diseases, bone diseases, osteoporosis, spinal diseases, back pain, gout, fractures, sprains, sports injuries,



osteogenesis imperfecta, muscle wasting (cachexia), renal osteodystrophy, cartilage injuries, joint replacement and osteoarthritis; pharmaceutical preparations for use in ophthalmology; pharmaceutical preparations for the treatment of dermatological diseases and disorders namely dermatitis, skin and skin structure infections namely bacterial skin infections, fungal skin infections, viral skin infections and parasitic skin infections, psoriasis, eczema and sexually transmitted diseases; pharmaceutical preparations for the treatment of hormonal related diseases and disorders namely hypogonadism, testosterone/androgen disorders and estrogen disorders; pharmaceutical preparations for the treatment of gastrointestinal related diseases and disorders namely irritable bowel disorders and symptoms, digestive disorders and acid-related disorders; pharmaceutical preparations for the treatment of sexual dysfunction namely erectile dysfunction, male and female sexual dysfunction disorders namely arousal disorder, pain disorder, desire disorder and orgasm disorder; pharmaceutical preparations for the treatment of genitourinary diseases namely urological diseases and disorders; pharmaceutical preparations for the treatment of gynaecological diseases and disorders namely amenorrhoea, dysmenorrhoea and infertility; pharmaceutical hormonal preparations namely corticosteroids, hormone replacement therapy preparations, oral contraceptives, thyroid hormone preparations; pharmaceutical preparations for the treatment of incontinence, prostate diseases and disorders, bladder diseases and disorders; pharmaceutical preparations for the treatment of sexually transmitted diseases, inflammatory pelvic diseases, vasomotor/menopausal symptoms, endometriosis/uterine fibroids, Leiomyoma, endourology/stone, pre-eclampsia and pre-term labour; pharmaceutical preparations for the treatment of prostatitis, nephritis, cystitis, vaginitis, renal disease; pharmaceutical preparations for the treatment of premenstrual dysphoric disorder, premenstrual syndrome, male hypogonadism and hormonal disorders namely polycystic ovary syndrome; pharmaceutical preparations for the treatment of hepatological related diseases namely hepatitis, non-alcoholic fatty liver disease (NAFLD), non-alcoholic steatohepatitis (NASH), liver fibroids, and cirrhosis; pharmaceutical preparations for the treatment of alopecia and androgenic alopecia (male pattern baldness); pharmaceutical preparations for the treatment of psychiatric diseases and disorders namely mood disorders, anxiety disorders, cognitive disorders, schizophrenia, and psychoses; pharmaceutical preparations for the treatment of damaged skin and tissue namely bee stings, sunburn, rashes, sores, corns, calluses and acne; pharmaceutical preparations for the treatment of inflammatory connective tissue diseases and injuries; pharmaceutical preparations for the treatment of malaria; pharmaceutical preparations for the treatment of tuberculosis; allergy medications; vaccines, namely prophylactic and therapeutic vaccines for humans; pharmaceutical preparations for the treatment of neurological diseases and disorders namely Parkinsons disease, Alzheimers disease, Huntingtons disease, dementia, migraine, cerebral palsy, brain injury, spinal cord injury, seizure disorders, epilepsy, restless legs syndrome, pain, neuropathic pain, inflammatory-related pain, fibromyalgia, stroke, multiple sclerosis, insomnia; pharmaceutical preparations for the treatment of central nervous system diseases and disorders namely central nervous system infections, brain diseases, central nervous system movement disorders, ocular motility disorders, spinal cord diseases, depression and anxiety and their related disorders namely schizophrenia and psychoses; pharmaceutical preparations for the treatment of muscular dystrophy.

### Claims

Priority Filing Date: August 12, 2021, Country or Office: UNITED KINGDOM, Application No: UK0003680697 in association with the same kind of goods

**Application Number** 2,156,115  
**International Registration Number** 1634459  
**Language of Application** English

**Filing Date** 2021-10-14

## APPLICANT AND AGENT DETAILS

### Applicant

Glaxo Group Limited  
980 Great West Road  
BRENTFORD, Middlesex TW8 9GS  
UNITED KINGDOM

### Agent

BORDEN LADNER GERVAIS LLP  
World Exchange Plaza, 100 Queen Street,  
Suite 1300, Ottawa, ONTARIO, K1P1J9

## TRADEMARK DETAILS

# SETKIQ

### Trademark Type

Standard Characters

### Goods

#### Class 05

Pharmaceutical preparations for use as anti-infectives; pharmaceutical preparations for the treatment of viral conditions, namely human immunodeficiency virus (HIV), human papilloma virus, respiratory syncytial virus, hepatitis, herpes genitalis, herpes labialis, herpes simplex virus, varicella-zoster virus, Epstein-Barr virus and cytomegalovirus; pharmaceutical preparations for the treatment and prevention of respiratory diseases and disorders and their symptoms; pharmaceutical preparations for the treatment of immune system related diseases and disorders, namely immunosuppressants; pharmaceutical preparations for the treatment of immunologic diseases and disorders namely, autoimmune diseases and disorders; pharmaceutical preparations for the treatment of atherosclerosis; pharmaceutical preparations for the treatment of viral conditions namely human immunodeficiency virus (HIV), HPV, RSV, hepatitis, herpes genitalis, herpes labialis, herpes simplex virus, varicella-zoster virus, Epstein-Barr virus and cytomegalovirus; pharmaceutical preparations for the treatment and prevention of metabolic related diseases and disorders namely disorders of the endocrine system, namely growth and thyroid disorders, diabetes, metabolic syndrome, obesity, weight loss and weight management; pharmaceutical preparations for the treatment and prevention of cardiovascular, cardiopulmonary, cardio-renal and renal diseases and disorders; pharmaceutical preparations for the prevention and treatment of oncological diseases and disorders; pharmaceutical preparations for the treatment of inflammation and inflammatory related diseases and disorders namely arthritis, rheumatoid arthritis, inflammatory bowel diseases, inflammatory connective tissue diseases, vasculitis, synovitis; pharmaceutical preparations for the prevention and treatment of sequelae of oncologic diseases and their treatment namely nausea and vomiting, hematologic depression, mucositis, cachexia, pain, bone pain and fatigue; pharmaceutical preparations for the treatment of blood-related diseases and disorders namely thrombocytopenia, coagulation disorders, bleeding disorders, platelet disorders, blood vessel disorders, sickle-cell disease and its related disorders, anemias, sepsis and infections in and of the blood; pharmaceutical preparations for the treatment of musculoskeletal diseases, disorders and injuries namely connective tissue diseases, bone diseases, osteoporosis, spinal diseases, back pain, gout, fractures, sprains, sports injuries,

osteogenesis imperfecta, muscle wasting (cachexia), renal osteodystrophy, cartilage injuries, joint replacement and osteoarthritis; pharmaceutical preparations for use in ophthalmology; pharmaceutical preparations for the treatment of dermatological diseases and disorders namely dermatitis, skin and skin structure infections namely bacterial skin infections, fungal skin infections, viral skin infections and parasitic skin infections, psoriasis, eczema and sexually transmitted diseases; pharmaceutical preparations for the treatment of hormonal related diseases and disorders namely hypogonadism, testosterone/androgen disorders and estrogen disorders; pharmaceutical preparations for the treatment of gastrointestinal related diseases and disorders namely irritable bowel disorders and symptoms, digestive disorders and acid-related disorders; pharmaceutical preparations for the treatment of sexual dysfunction namely erectile dysfunction, male and female sexual dysfunction disorders namely arousal disorder, pain disorder, desire disorder and orgasm disorder; pharmaceutical preparations for the treatment of genitourinary diseases namely urological diseases and disorders; pharmaceutical preparations for the treatment of gynaecological diseases and disorders namely amenorrhoea, dysmenorrhoea and infertility; pharmaceutical hormonal preparations namely corticosteroids, hormone replacement therapy preparations, oral contraceptives, thyroid hormone preparations; pharmaceutical preparations for the treatment of incontinence, prostate diseases and disorders, bladder diseases and disorders; pharmaceutical preparations for the treatment of sexually transmitted diseases, inflammatory pelvic diseases, vasomotor/menopausal symptoms, endometriosis/uterine fibroids, Leiomyoma, endourology/stone, pre-eclampsia and pre-term labour; pharmaceutical preparations for the treatment of prostatitis, nephritis, cystitis, vaginitis, renal disease; pharmaceutical preparations for the treatment of premenstrual dysphoric disorder, premenstrual syndrome, male hypogonadism and hormonal disorders namely polycystic ovary syndrome; pharmaceutical preparations for the treatment of hepatological related diseases namely hepatitis, non-alcoholic fatty liver disease (NAFLD), non-alcoholic steatohepatitis (NASH), liver fibroids, and cirrhosis; pharmaceutical preparations for the treatment of alopecia and androgenic alopecia (male pattern baldness); pharmaceutical preparations for the treatment of psychiatric diseases and disorders namely mood disorders, anxiety disorders, cognitive disorders, schizophrenia, and psychoses; pharmaceutical preparations for the treatment of damaged skin and tissue namely bee stings, sunburn, rashes, sores, corns, calluses and acne; pharmaceutical preparations for the treatment of inflammatory connective tissue diseases and injuries; pharmaceutical preparations for the treatment of malaria; pharmaceutical preparations for the treatment of tuberculosis; allergy medications; vaccines, namely prophylactic and therapeutic vaccines for humans; pharmaceutical preparations for the treatment of neurological diseases and disorders namely Parkinsons disease, Alzheimers disease, Huntingtons disease, dementia, migraine, cerebral palsy, brain injury, spinal cord injury, seizure disorders, epilepsy, restless legs syndrome, pain, neuropathic pain, inflammatory-related pain, fibromyalgia, stroke, multiple sclerosis, insomnia; pharmaceutical preparations for the treatment of central nervous system diseases and disorders namely central nervous system infections, brain diseases, central nervous system movement disorders, ocular motility disorders, spinal cord diseases, depression and anxiety and their related disorders namely schizophrenia and psychoses; pharmaceutical preparations for the treatment of muscular dystrophy.

### Claims

Priority Filing Date: August 12, 2021, Country or Office: UNITED KINGDOM, Application No: UK00003680750 in association with the same kind of goods

**Application Number** 2,156,150  
**International Registration Number** 1634274  
**Language of Application** English

**Filing Date** 2021-10-21

## APPLICANT DETAILS

### Applicant

Maroo On Inc.  
1247, Dureungyuri-ro, Ochang-eup,  
Cheongwon-gu  
Cheongju-si Chungcheongbuk-do  
REPUBLIC OF KOREA

## TRADEMARK DETAILS

### Trademark Type

Design

### Visual Representation

GRID MAROO

### Goods

#### Class 09

Computer software for network management; computer software for managing and monitoring power plants and power grids; computer software for managing and monitoring electrical grids; computer software for monitoring the performance and fault detection of electrical grids; non-downloadable software for managing and monitoring electrical grids.

### Services

#### Class 42

Providing non-downloadable software for managing and monitoring power plants and power grids; providing computer software for fault detection and diagnosis of electrical grids; providing non-downloadable software for fault detection and diagnosis of electrical grids.

### Claims

Priority Filing Date: September 27, 2021, Country or Office: REPUBLIC OF KOREA, Application No: 4020210196911 in association with the same kind of goods and in association with the same kind of services

**Application Number** 2,156,194  
**International Registration Number** 1634224  
**Language of Application** English

**Filing Date** 2021-11-01

## **APPLICANT AND AGENT DETAILS**

### **Applicant**

SURAJ BAHIRWANI  
Rm. 201, Blue Chip Building,  
Juhu Lane Andheri, West Mumbai  
Maharashtra 400058  
INDIA

### **Agent**

ERIN MCEWEN  
NELLIGAN O'BRIEN PAYNE LLP , 50  
O'Connor Street, Suite 300, Ottawa,  
ONTARIO, K1P6L2

## **TRADEMARK DETAILS**

### **Trademark Type**

Design

### **Visual Representation**

**GUMMAZING**

### **Goods**

**Class 05**

Multivitamin gummies.

**Application Number** 2,156,199  
**International Registration Number** 1288417  
**Language of Application** English

**Filing Date** 2021-11-02

## APPLICANT AND AGENT DETAILS

### Applicant

GUILLERMO F. CASAR OLMOS  
C/Sorzano, 19 3ªA  
E-28043 MADRID  
SPAIN

### Agent

MOFFAT & CO.  
P.O. Box 2088, Station D, Ottawa, ONTARIO,  
K1P5W3

## TRADEMARK DETAILS

### Trademark Type

Design

### Visual Representation

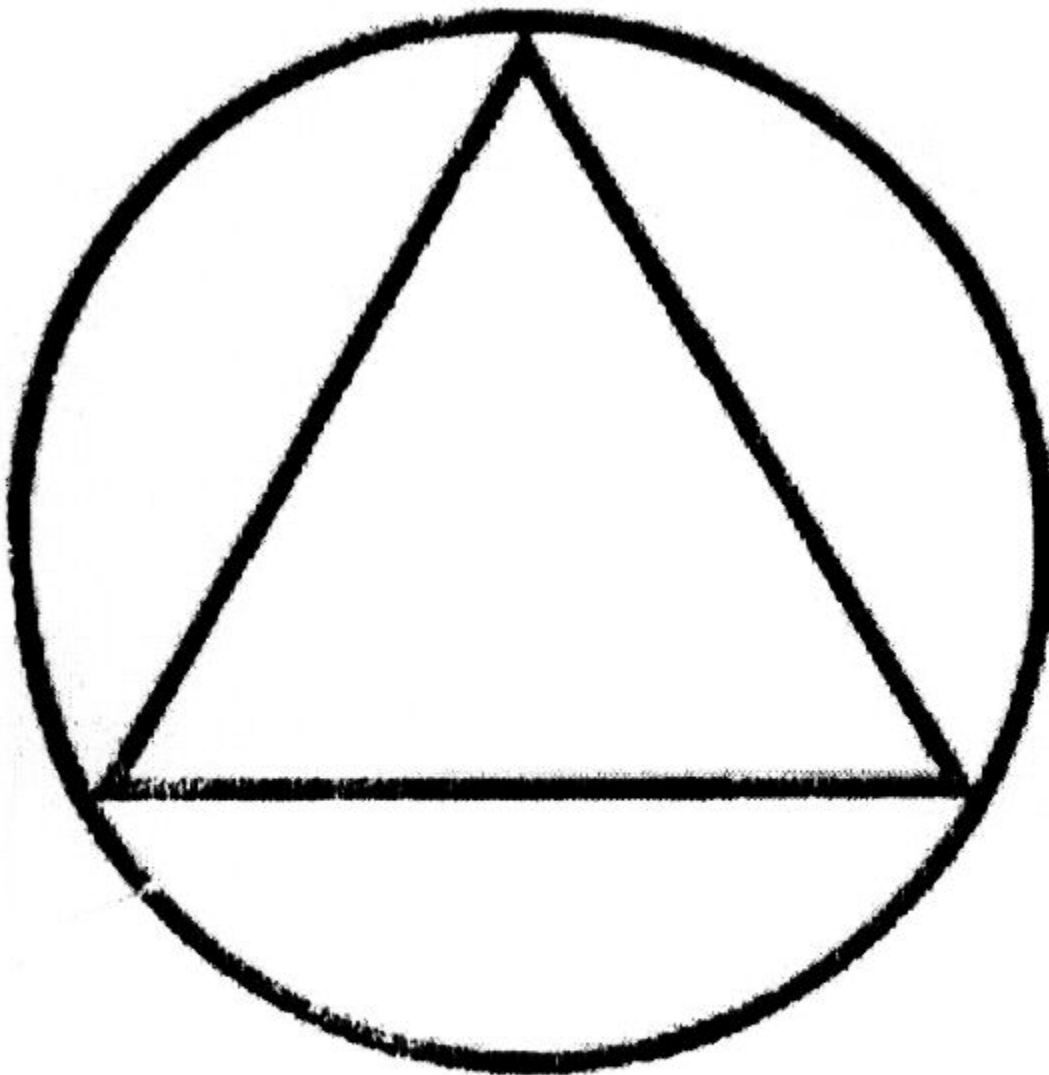

Tiwi

**Goods**

**Class 09**

Spectacles, sunglasses, eyeglasses.

**Application Number** 2,156,210  
**International Registration Number** 1635323  
**Language of Application** English

**Filing Date** 2021-11-04

## APPLICANT AND AGENT DETAILS

### Applicant

Together We Rise Corporation  
580 W. Lambert Rd.  
Brea CA 92821  
UNITED STATES OF AMERICA

### Agent

SMART & BIGGAR LP  
1100-150 York street, TORONTO, ONTARIO,  
M5H3S5

## TRADEMARK DETAILS

# FOSTER TOGETHER

### Trademark Type

Standard Characters

### Goods

#### Class 16

(1) Stickers; bumper stickers.

#### Class 18

(2) Tote bags.

#### Class 21

(3) Mugs; drinking glasses, namely, tumblers.

#### Class 25

(4) Clothing, namely, t-shirts, jackets.

#### Class 26

(5) Ornamental novelty pins; embroidered patches for clothing.

#### Class 28

(6) Toy stuffed animals.

### Services

#### Class 35

(1) Recruitment of foster care parents; charitable services promoting public interest and awareness for the support of children in foster care; charitable services, namely, facilitating the administrative coordination of the provision of charitable gifts and services by third parties to families adopting children; charitable services, namely, organizing and conducting volunteer programs and events all being in the nature of community service, family service, and school service projects aimed at supporting children in foster care and their families; charitable services, namely, organizing and conducting volunteer programs and events all being in the nature of community service, family service, and school service projects to provide new and used clothing to underserved youth; charitable services, namely, organizing and conducting volunteer programs and community service



projects; charitable services, namely, organizing and conducting volunteer programs providing team building events and volunteer opportunities to businesses, such events and opportunities all being in the nature of community service, family service, and school service.

**Class 36**

(2) Charitable fundraising services, namely, raising funds to administer programs to support children in foster care.

**Class 41**

(3) Educational services, namely, providing classes, workshops and training for foster care families in the fields of foster care and foster parenting; educational services, namely, providing classes, webinars, and presentations on foster care and foster parenting; educational services and training services, namely, classes and workshops for adults for the purpose of serving as foster parents for youth in foster care; educational services and training services, namely, classes and workshops for young adults transitioning from foster care to independent living for the purpose of promoting the development of everyday life skills.

**Class 45**

(4) Foster care agency services; providing information in the field of foster care and foster parenting; counseling services relating to the foster care of children.

**Claims**

Priority Filing Date: May 11, 2021, Country or Office: UNITED STATES OF AMERICA, Application No: 90702259 in association with the same kind of goods and in association with the same kind of services

**Application Number** 2,156,221  
**International Registration Number** 1635024  
**Language of Application** English

**Filing Date** 2021-11-05

## APPLICANT DETAILS

**Applicant**  
RED SLATE BRANDS LLC  
SUITE 111,  
50 WOODSIDE PLAZA  
REDWOOD CITY CA 94061  
UNITED STATES OF AMERICA

## TRADEMARK DETAILS

**Trademark Type**  
Design

### Visual Representation



### Trademark Description

The mark consists of a fanciful depiction of trees are to the left of the words "balsam hill", all of which are red/burgundy in color.

### Colour Claim

The color(s) red/burgundy is/are claimed as a feature of the mark. The mark consists of a fanciful depiction of trees are to the left of the words "balsam hill", all of which are red/burgundy in color.

### Goods

#### Class 26

(1) Artificial christmas garlands; artificial christmas wreaths; artificial flower arrangements; artificial flower arrangements in containers; artificial flower wreaths; artificial topiaries; pre-lit artificial christmas garlands; pre-lit artificial christmas wreaths.

#### Class 28

(2) Artificial christmas trees; christmas stockings; christmas tree ornaments, namely, bells; christmas tree skirts; christmas tree stand covers; christmas tree stands; pre-lit artificial christmas trees; christmas tree ornaments and decorations.

### Services

**Class 35**

On-line retail store services featuring household decorations, holiday decorations, decorative accessories, storage containers and gifts; retail store services featuring household decorations, holiday decorations, decorative accessories, storage containers and gifts.

**Claims**

Priority Filing Date: May 07, 2021, Country or Office: UNITED STATES OF AMERICA, Application No: 90696128 in association with the same kind of goods and in association with the same kind of services

**Application Number** 2,156,244  
**International Registration Number** 1635057  
**Language of Application** English

**Filing Date** 2021-11-10

## APPLICANT DETAILS

### Applicant

The Better Tomorrow Project, LLC  
1680 Michigan Avenue, Ste. 817  
Miami Beach FL 33139  
UNITED STATES OF AMERICA

## TRADEMARK DETAILS

### Trademark Type

Design

### Visual Representation

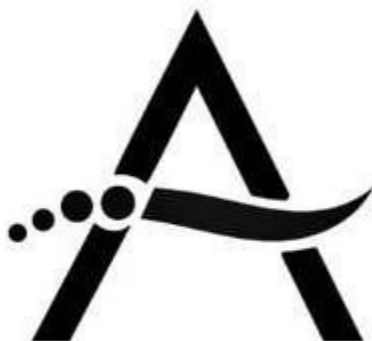

# ATMOFIZER

### Trademark Description

The mark consists of the stylized word "ATMOFIZER" with a stylized letter "A" appearing directly above it wherein the curved shaped element within the letter "A" defines the horizontal element of the letter "A". The curved shaped element extends beyond the vertically arranged elements of the letter "A" and the curved shaped element is defined by four circles each increasing in size from left to right, with a leaf shaped element extending proximate to the right of the right most circle of the four circles.

### Goods

#### Class 11

Air disinfecting, purification, and sanitization units; units for disinfecting, purifying and sanitizing spaces, water, surfaces, and air.

### Claims

Priority Filing Date: October 20, 2021, Country or Office: UNITED STATES OF AMERICA,  
Application No: 97084218 in association with the same kind of goods

**Application Number** 2,156,254  
**International Registration Number** 1634154  
**Language of Application** English

**Filing Date** 2021-11-11

### APPLICANT AND AGENT DETAILS

**Applicant**

Get Together Inc.  
1748 Shattuck Avenue, No. 130  
Berkeley CA 94109  
UNITED STATES OF AMERICA

**Agent**

SMART & BIGGAR LP  
1100-150 York street, TORONTO, ONTARIO,  
M5H3S5

### TRADEMARK DETAILS

**Trademark Type**

Design

**Visual Representation**



**Trademark Description**

The mark consists of a partial happy face appearing inside a rounded square with 9 smaller squares inside, the corner squares being rounded.

**Goods****Class 09**

Downloadable mobile application for social networking, calendaring, and planning.

**Services****Class 42**

Providing temporary use of non-downloadable software for social networking, calendaring, and planning.

**Application Number** 2,156,295  
**International Registration Number** 1634162  
**Language of Application** English

**Filing Date** 2021-11-17

## APPLICANT AND AGENT DETAILS

### Applicant

Beiersdorf AG  
Unnastr. 48  
20253 Hamburg  
GERMANY

### Agent

GOWLING WLG (CANADA) LLP  
SUITE 1600, 1 FIRST CANADIAN PLACE, 100  
KING STREET WEST, TORONTO, ONTARIO,  
M5X1G5

## TRADEMARK DETAILS

### Trademark Type

Design

### Visual Representation

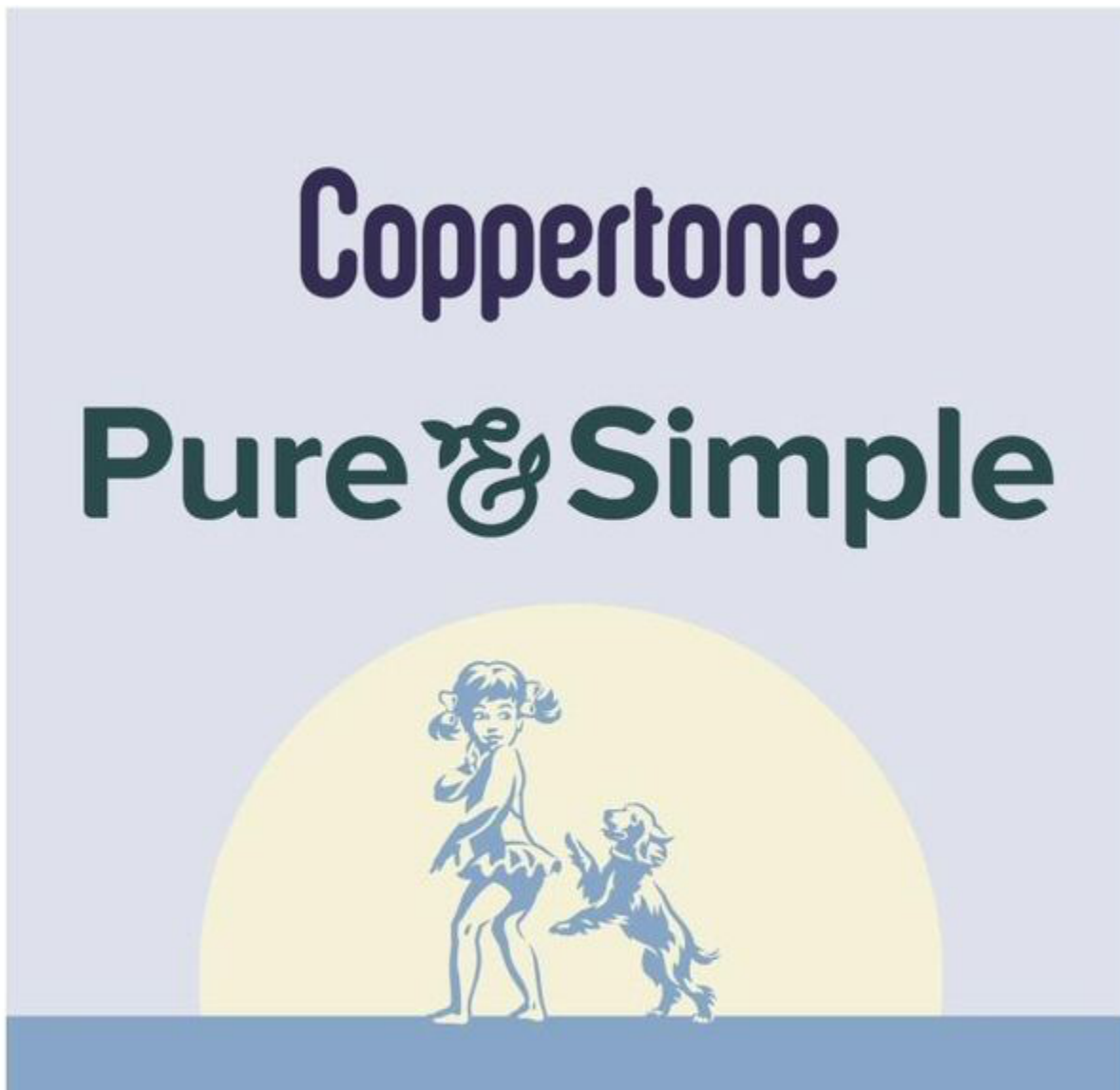

**Colour Claim**

Colour is claimed as a feature of the trademark. The colours medium blue, off white, light blue, blue-green and dark blue are claimed as a feature of the trademark. The wording COPPERTONE is dark blue and the wording PURE & SIMPLE is blue-green, all superimposed on a quadrilateral background in light blue. The girl and dog designs are medium blue superimposed on a semi-circle design background in off white. The rectangle underneath all of the other elements is medium blue.

**Goods****Class 03**

Non-medicated cosmetics; non-medicated preparations for body and beauty care, namely sunscreen preparations; non-medicated sun care preparations for cosmetic and dermatological purposes, non-medicated after sun preparations for cosmetic and dermatological purposes.

**Claims**

Priority Filing Date: July 22, 2021, Country or Office: EUIPO (EU), Application No: 018519082 in association with the same kind of goods



**Application Number** 2,156,306  
**International Registration Number** 1634578  
**Language of Application** English

**Filing Date** 2021-11-18

## APPLICANT DETAILS

**Applicant**  
CELLTRION, INC.  
23, Academy-ro, Yeonsu-gu  
Incheon 22014  
REPUBLIC OF KOREA

## TRADEMARK DETAILS

# EYDENZELT

**Trademark Type**  
Standard Characters

**Goods**

**Class 05**

Ophthalmic preparations; pharmaceutical preparations for the treatment of angiogenesis.

**Claims**

Priority Filing Date: July 26, 2021, Country or Office: REPUBLIC OF KOREA, Application No: 4020210154021 in association with the same kind of goods

**Application Number** 2,156,341  
**International Registration Number** 1634520  
**Language of Application** English

**Filing Date** 2021-11-22

## APPLICANT AND AGENT DETAILS

### Applicant

TENUTE PICCINI S.P.A.  
Località Piazzole  
I-53011 Castellina in Chianti (SI)  
ITALY

### Agent

ROBIC  
630, boul. René-Lévesque Ouest, 20e étage,  
Montréal, QUEBEC, H3B1S6

## TRADEMARK DETAILS

# PINOCCHIO

### Trademark Type

Standard Characters

### Goods

#### Class 33

Red wine, white wine and rosé-wine.

**Application Number** 2,156,373  
**International Registration Number** 1634244  
**Language of Application** English

**Filing Date** 2021-11-23

## APPLICANT DETAILS

### Applicant

Make-Up Art Cosmetics Inc.  
767 Fifth Avenue  
New York NY 10153  
UNITED STATES OF AMERICA

## TRADEMARK DETAILS

# CONNECT IN COLOUR

### Trademark Type

Standard Characters

### Goods

#### Class 03

Cosmetics; fragrances for personal use; non-medicated skin care preparations.

### Claims

Priority Filing Date: November 12, 2021, Country or Office: UNITED STATES OF AMERICA,  
Application No: 97122684 in association with the same kind of goods

**Application Number** 2,156,374  
**International Registration Number** 1634242  
**Language of Application** English

**Filing Date** 2021-11-23

## APPLICANT AND AGENT DETAILS

### Applicant

Brius Technologies, Inc.  
2611 Westgrove Drive, Suite 109  
Carrollton TX 75006  
UNITED STATES OF AMERICA

### Agent

CLARK WILSON LLP  
900 - 885 WEST GEORGIA STREET,  
VANCOUVER, BRITISH COLUMBIA, V6C3H1

## TRADEMARK DETAILS

# INDEPENDENT MOVERS

### Trademark Type

Standard Characters

### Goods

#### Class 10

Dental apparatus, namely, orthodontic appliances.

### Claims

Priority Filing Date: October 25, 2021, Country or Office: UNITED STATES OF AMERICA,  
Application No: 97090528 in association with the same kind of goods

**Application Number** 2,156,379  
**International Registration Number** 1635388  
**Language of Application** English

**Filing Date** 2021-11-23

## APPLICANT AND AGENT DETAILS

### Applicant

Food Allergy Research & Education, Inc.  
7901 Jones Branch Drive  
McLean VA 22102  
UNITED STATES OF AMERICA

### Agent

SMART & BIGGAR LP  
1100-150 York street, TORONTO, ONTARIO,  
M5H3S5

## TRADEMARK DETAILS

### Trademark Type

Design

### Visual Representation



**Trademark Description**

The mark consists of a design of a shaded plus sign centered inside of a circle with a thick shaded outer circle. A design of a fork is angled diagonally on the plus sign.

**Services****Class 36**

(1) Charitable fundraising services by means of organizing and conducting projects to promote awareness of food allergies that will provide financial support to food allergy research and education.

**Class 41**

(2) Educational services, namely, providing on-line and live classes, seminars and workshop courses in the field of food allergy education.

**Application Number** 2,156,403  
**International Registration Number** 1634822  
**Language of Application** English

**Filing Date** 2021-11-26

## APPLICANT AND AGENT DETAILS

### Applicant

Fireheart Music, Inc.  
2785 Pacific Coast Hwy., Suite E-909  
Torrance CA 90505  
UNITED STATES OF AMERICA

### Agent

ANNA CLARK  
(DENTONS CANADA LLP), 99 Bank Street,  
Suite 1420, Ottawa, ONTARIO, K1P1H4

## TRADEMARK DETAILS

# Stu Dying

### Trademark Type

Standard Characters

### Goods

#### Class 09

Digital music downloadable from the Internet.

### Claims

Priority Filing Date: July 06, 2021, Country or Office: UNITED STATES OF AMERICA, Application No: 90813268 in association with the same kind of goods

**Application Number** 2,156,409  
**International Registration Number** 1634689  
**Language of Application** English

**Filing Date** 2021-11-29

## APPLICANT AND AGENT DETAILS

### Applicant

Mermade Hair Pty Ltd  
1/900 Albany Highway  
East Victoria Park WA 6101  
AUSTRALIA

### Agent

BERESKIN & PARR LLP/S.E.N.C.R.L., S.R.L.  
SCOTIA PLAZA, 40 KING STREET WEST,  
40th FLOOR, TORONTO, ONTARIO, M5H3Y2

## TRADEMARK DETAILS

# The Cutie

### Trademark Type

Standard Characters

### Goods

#### Class 08

Hand implements for hair curling; electric hand implements for hair curling; electric hair curling irons (hand implements); crimping irons; electric hair styling wands (hand implements); electric hair waving tongs; hand operated electric hair waving tool.

### Claims

Priority Filing Date: October 12, 2021, Country or Office: AUSTRALIA, Application No: 2216460 in association with the same kind of goods



**Application Number** 2,157,340  
**International Registration Number** 1636780  
**Language of Application** English

**Filing Date** 2021-10-26

## APPLICANT AND AGENT DETAILS

### Applicant

Apple Inc.  
One Apple Park Way  
Cupertino CA 95014  
UNITED STATES OF AMERICA

### Agent

BAKER & MCKENZIE LLP  
BROOKFIELD PLACE, 181 BAY STREET,  
SUITE 2100, P.O. BOX 874, TORONTO,  
ONTARIO, M5J2T3

## TRADEMARK DETAILS

# APPLE AIRTAG

### Trademark Type

Standard Characters

### Goods

#### Class 18

Carrying cases of leather, key cases, leather straps, leather key cases, luggage tags.

### Claims

Priority Filing Date: May 04, 2021, Country or Office: JAMAICA, Application No: 83234 in association with the same kind of goods

**Application Number** 2,157,468  
**International Registration Number** 1635611  
**Language of Application** English

**Filing Date** 2021-11-18

## APPLICANT AND AGENT DETAILS

### Applicant

Beiersdorf AG  
Unnastr. 48  
20253 Hamburg  
GERMANY

### Agent

GOWLING WLG (CANADA) LLP  
SUITE 1600, 1 FIRST CANADIAN PLACE, 100  
KING STREET WEST, TORONTO, ONTARIO,  
M5X1G5

## TRADEMARK DETAILS

### Trademark Type

Design

### Visual Representation



**Colour Claim**

Colour is claimed as a feature of the trademark. The colours medium green, off white, light green, blue-green and dark blue are claimed as a feature of the trademark. The wording COPPERTONE is dark blue and the wording PURE & SIMPLE is blue-green, all superimposed on a quadrilateral background in light green. The wording KIDS is off white with a blue-green outline and superimposed on a rectangle background in medium green. The girl and dog designs are medium green superimposed on a semi-circle design background in off white.

**Goods****Class 03**

Non-medicated cosmetics; non-medicated preparations for body and beauty care, namely sunscreen preparations; non-medicated sun care preparations for cosmetic and dermatological purposes, non-medicated after sun preparations for cosmetic and dermatological purposes.

**Claims**

Priority Filing Date: July 22, 2021, Country or Office: EUIPO (EU), Application No: 018519084 in association with the same kind of goods

**Application Number** 2,158,446  
**International Registration Number** 1637382  
**Language of Application** English

**Filing Date** 2021-11-10

## APPLICANT DETAILS

### Applicant

The Better Tomorrow Project, LLC  
1680 Michigan Avenue, Ste. 817  
Miami Beach FL 33139  
UNITED STATES OF AMERICA

## TRADEMARK DETAILS

### Trademark Type

Design

### Visual Representation

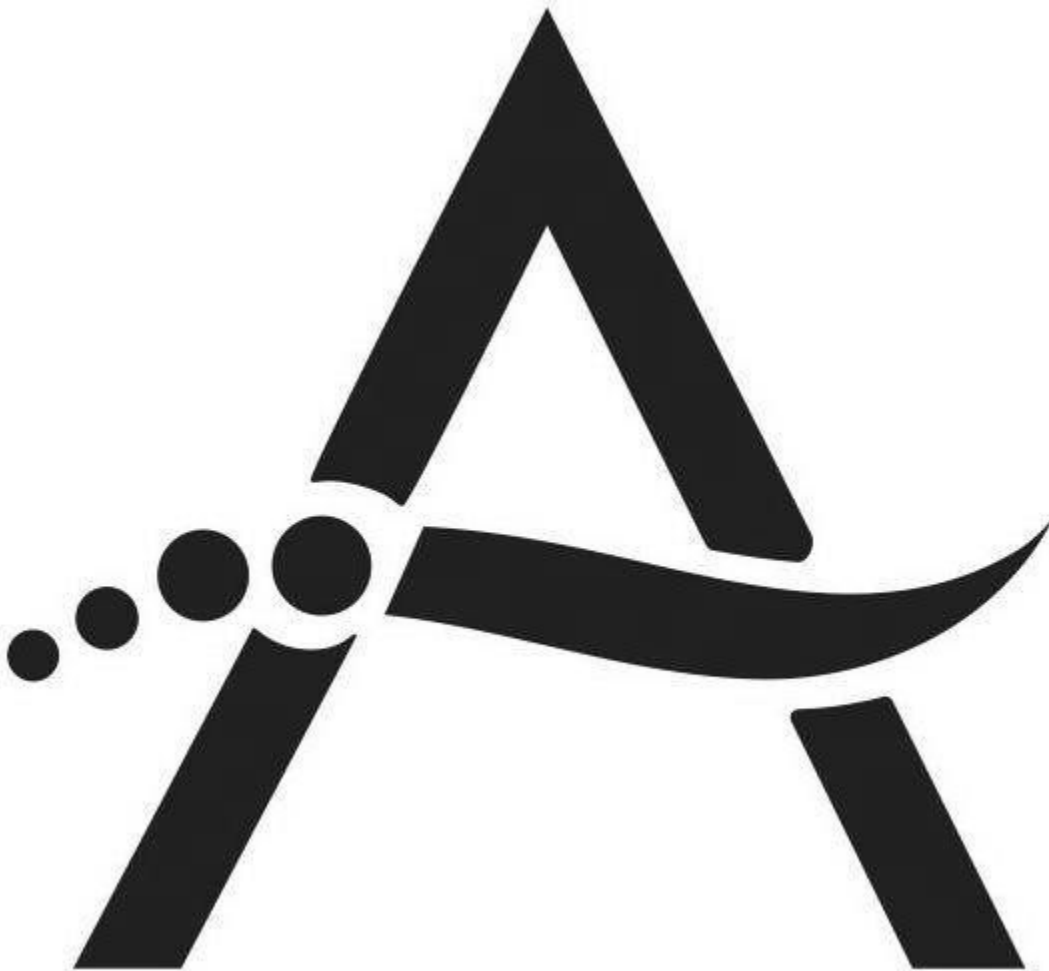

### Trademark Description

The mark consists of a stylized letter "A" wherein the curved shaped element within the letter "A" defines the horizontal element of the letter "A". The curved shaped element extends beyond the

vertically arranged elements of the letter "A" and the curved shaped element is defined by four circles each increasing in size from left to right.

**Goods****Class 11**

Air disinfecting, purification, and sanitization units; units for disinfecting, purifying and sanitizing spaces, water, surfaces, and air.

**Claims**

Priority Filing Date: October 26, 2021, Country or Office: UNITED STATES OF AMERICA,  
Application No: 97092593 in association with the same kind of goods

**Application Number** 2,158,447  
**International Registration Number** 1637065  
**Language of Application** English

**Filing Date** 2021-11-10

## APPLICANT DETAILS

### Applicant

The Better Tomorrow Project, LLC  
1680 Michigan Avenue, Ste. 817  
Miami Beach FL 33139  
UNITED STATES OF AMERICA

## TRADEMARK DETAILS

### Trademark Type

Design

### Visual Representation



### Trademark Description

The mark consists of the term "ATMOFIZER" wherein the stylized letter "A" has a curved shaped element that defines the horizontal element of the stylized letter "A". The curved shaped element extends beyond the vertically arranged elements of the stylized letter "A" and the curved shaped element is defined by four circles each increasing in size from left to right, with a leaf shaped element extending proximate to the right of the right most circle of the four circles.

### Goods

#### Class 11

Air disinfecting, purification, and sanitization units; units for disinfecting, purifying and sanitizing spaces, water, surfaces, and air.

### Claims

Priority Filing Date: October 20, 2021, Country or Office: UNITED STATES OF AMERICA,  
Application No: 97084198 in association with the same kind of goods

**Application Number** 2,158,502  
**International Registration Number** 1637425  
**Language of Application** English

**Filing Date** 2021-11-23

## APPLICANT DETAILS

### Applicant

Fuego, Inc.  
220 South 40th Street, Suite 250  
Philadelphia PA 19104  
UNITED STATES OF AMERICA

## TRADEMARK DETAILS

### Trademark Type

Design

### Visual Representation

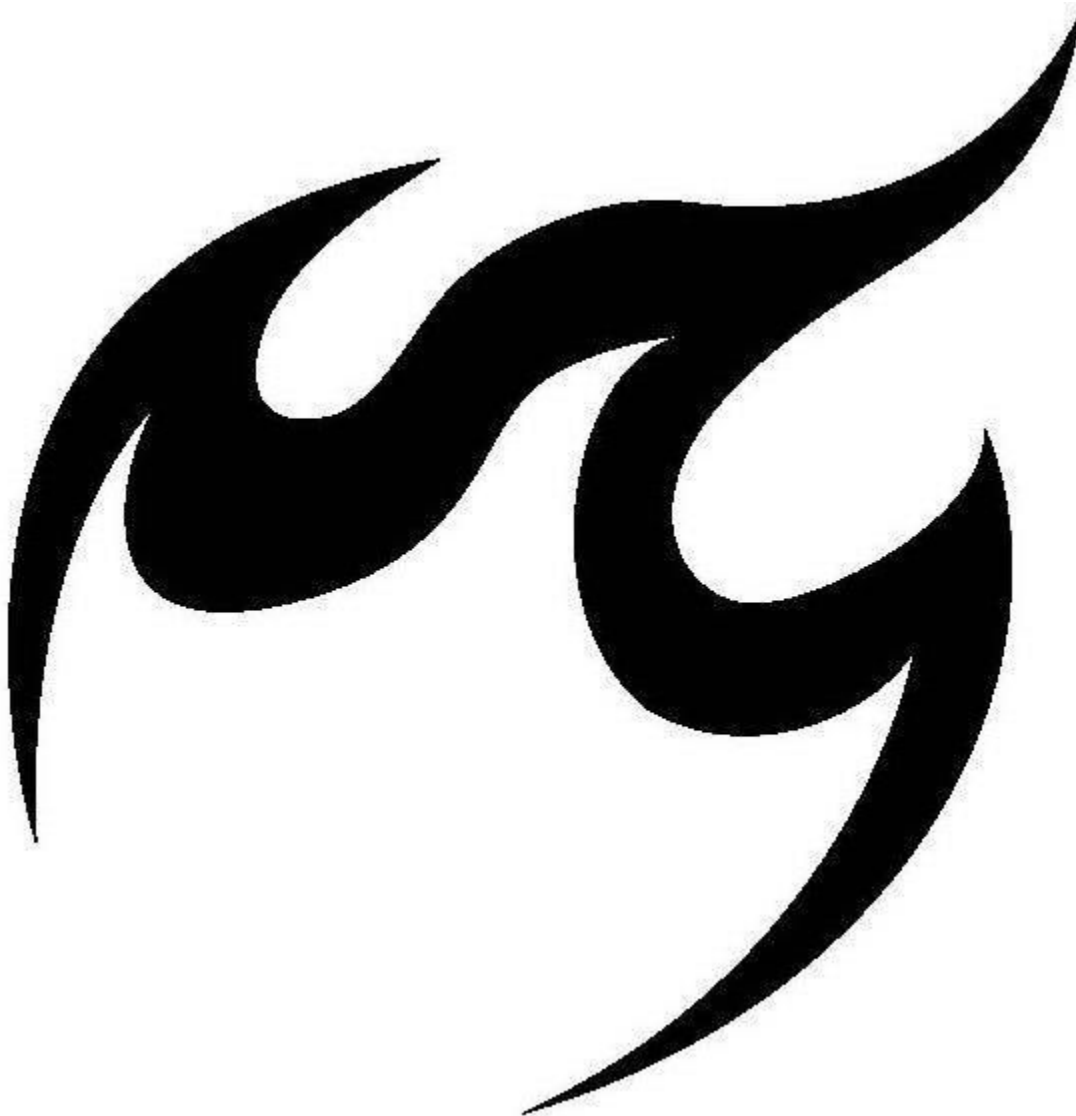

**Trademark Description**

The mark consists of abstract flame.

**Goods**

**Class 25**

Shoes.

**Services**

**Class 35**

Online retail store services featuring shoes.



**Application Number** 2,159,647  
**Language of Application** French

**Filing Date** 2022-01-12

## APPLICANT AND AGENT DETAILS

### Applicant

FROMAGERIE BERGERON INC.  
3837 Rte Marie-Victorin  
Saint-Antoine-de-Tilly  
QUÉBEC  
G0S2C0

### Agent

STEPHANE LAMONDE  
(O'BRIEN AVOCATS), 140 GRANDE-ALLEE  
EST, BUREAU 600, QUEBEC, QUÉBEC,  
G1R5M8

## TRADEMARK DETAILS

**Trademark Type**

Design

**Visual Representation**

BERGERON  
CLASSIQU  
FUMÉ | SMOKI

**Colour Claim**

Colour is claimed as a feature of the trademark. The words BERGERON CLASSIQUE FUMÉ | SMOKED are brown (PANTONE\* (PMS) 463). \*PANTONE is a registered trademark.

**Goods****Class 29**

cheese

**Application Number** 2,160,007  
**International Registration Number** 1638923  
**Language of Application** English

**Filing Date** 2021-12-17

## APPLICANT AND AGENT DETAILS

### Applicant

Merck Sharp & Dohme B.V.  
Waarderweg 39  
NL-2031 BN Haarlem  
NETHERLANDS

### Agent

BORDEN LADNER GERVAIS LLP  
Bay Adelaide Centre, East Tower, 22 Adelaide  
St. West, TORONTO, ONTARIO, M5H4E3

## TRADEMARK DETAILS

# RIZBOSTIO

### Trademark Type

Standard Characters

### Goods

#### Class 05

Pharmaceutical preparations and substances for use in oncology

### Claims

Priority Filing Date: December 03, 2021, Country or Office: Benelux Office for IP (BOIP),  
Application No: 1455162 in association with the same kind of goods

**Application Number** 2,161,031  
**International Registration Number** 1639468  
**Language of Application** English

**Filing Date** 2021-08-06

## APPLICANT AND AGENT DETAILS

### Applicant

GoBrands, Inc.  
537 N 3rd Street  
Philadelphia PA 19123  
UNITED STATES OF AMERICA

### Agent

DEETH WILLIAMS WALL LLP  
150 YORK STREET, SUITE 400, TORONTO,  
ONTARIO, M5H3S5

## TRADEMARK DETAILS

# BASICALLY

### Trademark Type

Standard Characters

### Goods

#### Class 03

(1) All-purpose cleaning preparations; glass cleaners; all-purpose cleaning agents and preparations; all-purpose cleaning, scouring, washing and polishing preparations and substances; floor cleaning preparations and polishes; stain removers, namely, laundry stain removers, and all-purpose stain removers for household purposes; cloths, pads and wipes impregnated with cleaning, polishing, scouring and abrasive preparations for household use; laundry detergent; liquid and dry dishwashing soap.

#### Class 05

(2) Disinfecting wipes used to destroy or control micro-organisms on hard surfaces.

### Claims

Priority Filing Date: May 07, 2021, Country or Office: UNITED STATES OF AMERICA, Application No: 90697288 in association with the same kind of goods

**Application Number** 2,162,223  
**Language of Application** English

**Filing Date** 2022-01-26

## APPLICANT AND AGENT DETAILS

### Applicant

Home Depot International, Inc.  
2455 Paces Ferry Road, NW  
Atlanta, GA 30339  
UNITED STATES OF AMERICA

### Agent

BERESKIN & PARR LLP/S.E.N.C.R.L., S.R.L.  
SCOTIA PLAZA, 40 KING STREET WEST,  
40th FLOOR, TORONTO, ONTARIO, M5H3Y2

## TRADEMARK DETAILS

# HAMPTON BAY

### Trademark Type

Standard Characters

### Goods

#### Class 19

(1) Garden statues and ornaments made of stone, marble, concrete; Decorative statues and ornaments made of stone, marble, concrete

#### Class 20

(2) Garden statues and ornaments made of wood, plastic and plaster; Decorative statues and ornaments made of wood, plastic and plaster

#### Class 21

(3) Garden statues and ornaments made of ceramic, clay, earthenware, glass, porcelain and terracotta; Decorative statues and ornaments made of ceramic, clay, earthenware, glass, porcelain and terracotta

**Application Number** 2,162,224  
**Language of Application** English

**Filing Date** 2022-01-26

## APPLICANT AND AGENT DETAILS

### Applicant

Home Depot International, Inc.  
2455 Paces Ferry Road NW  
Atlanta, GA 30339  
UNITED STATES OF AMERICA

### Agent

BERESKIN & PARR LLP/S.E.N.C.R.L., S.R.L.  
SCOTIA PLAZA, 40 KING STREET WEST,  
40th FLOOR, TORONTO, ONTARIO, M5H3Y2

## TRADEMARK DETAILS

### Trademark Type

Design

### Visual Representation



### Goods

#### Class 19

(1) Garden statues and ornaments made of stone, marble, concrete; Decorative statues and ornaments made of stone, marble, concrete

#### Class 20

(2) Garden statues and ornaments made of wood, plastic and plaster; Decorative statues and ornaments made of wood, plastic and plaster

#### Class 21

(3) Garden statues and ornaments made of ceramic, clay, earthenware, glass, porcelain and terracotta; Decorative statues and ornaments made of ceramic, clay, earthenware, glass, porcelain and terracotta

**Application Number** 2,162,642  
**International Registration Number** 1640785  
**Language of Application** English

**Filing Date** 2021-12-29

## APPLICANT DETAILS

### Applicant

Daruguys LLC  
44 Via La Cumbre  
Greenbrae CA 94904  
UNITED STATES OF AMERICA

## TRADEMARK DETAILS

# DARUGUYS

### Trademark Type

Standard Characters

### Goods

#### Class 33

Alcoholic beverages except beers, namely wine.

### Claims

Priority Filing Date: August 18, 2021, Country or Office: UNITED STATES OF AMERICA,  
Application No: 90889732 in association with the same kind of goods

**Application Number** 2,162,685  
**Language of Application** English

**Filing Date** 2022-01-26

## APPLICANT AND AGENT DETAILS

### Applicant

Unilever Canada Inc.  
160 Bloor Street East, Suite 1400  
Toronto  
ONTARIO  
M4W3R2

### Agent

BAKER & MCKENZIE LLP  
BROOKFIELD PLACE, 181 BAY STREET,  
SUITE 2100, P.O. BOX 874, TORONTO,  
ONTARIO, M5J2T3

## TRADEMARK DETAILS

### Trademark Type

Design

### Visual Representation

*Dove*







**intensive  
repair**

**Goods**

**Class 03**

hair care preparations

**Application Number** 2,163,049  
**Language of Application** French

**Filing Date** 2022-01-29

## APPLICANT DETAILS

**Applicant**  
9380-0837 Québec inc.  
103-500 montée Masson  
Bureau #235  
Mascouche  
QUÉBEC  
J7K2L5

## TRADEMARK DETAILS

**Trademark Type**  
Design

**Visual Representation**



The logo consists of the letters 'E', 'S', 'O', 'F', and 'I' in a bold, sans-serif font. A vertical line is positioned between the 'E' and the 'S'. The letter 'S' is stylized with a gradient, transitioning from a dark color at the bottom to a lighter color at the top. The 'O' is a simple circle, and the 'F' and 'I' are simple vertical and horizontal strokes.**Colour Claim**

Colour is claimed as a feature of the trademark. The S in the "Le Sofia" logo is multicoloured. The colours represent the transition from the ground (grass green) to the sky (blue).

**Services****Class 36**

real property acquisition; apartment house management; real estate investment services; rental of real estate; rental of commercial real estate; building leasing; rental of residential housing; real estate investment; property asset management services

**Application Number** 2,163,422  
**Language of Application** French

**Filing Date** 2022-02-01

## APPLICANT DETAILS

### Applicant

Tommy Plante  
Sébastien Gagnon Ringuette  
17325 rue berube  
Bécancour  
QUÉBEC  
G9H4Y4

## TRADEMARK DETAILS

# Top Gun Nutrition

### Trademark Type

Standard Characters

### Goods

#### Class 05

(1) dietary supplement drink mixes for general health and wellbeing; vitamin and mineral dietary supplements; vitamin and mineral supplements

#### Class 32

(2) protein-enriched sports beverages

**Application Number** 2,163,443  
**Language of Application** French

**Filing Date** 2022-02-02

## APPLICANT DETAILS

### Applicant

Tella & Stella Inc.  
908-2855 rue montreuil  
G1V 0C9  
Québec  
QUÉBEC  
G1V0C8

## TRADEMARK DETAILS

# Tella & Stella

### Trademark Type

Standard Characters

### Goods

#### Class 18

bandanas for dogs; dog boots; dog collars; dog collars and leads; collars for cats; harness for cats; harness for dogs; dog leashes; coats for cats; dog coats; rain suits for dogs; wraps for dogs

Application Number 2,164,218  
International Registration Number 1607458  
Language of Application English

Filing Date 2022-01-03

**APPLICANT AND AGENT DETAILS**

**Applicant**

Marc Jacobs Trademarks, L.L.C.  
72 Spring Street  
New York NY 10012  
UNITED STATES OF AMERICA

**Agent**

ROBIC  
630, boul. René-Lévesque Ouest, 20e étage,  
Montréal, QUEBEC, H3B1S6

**TRADEMARK DETAILS**

**Trademark Type**

Design

**Visual Representation**

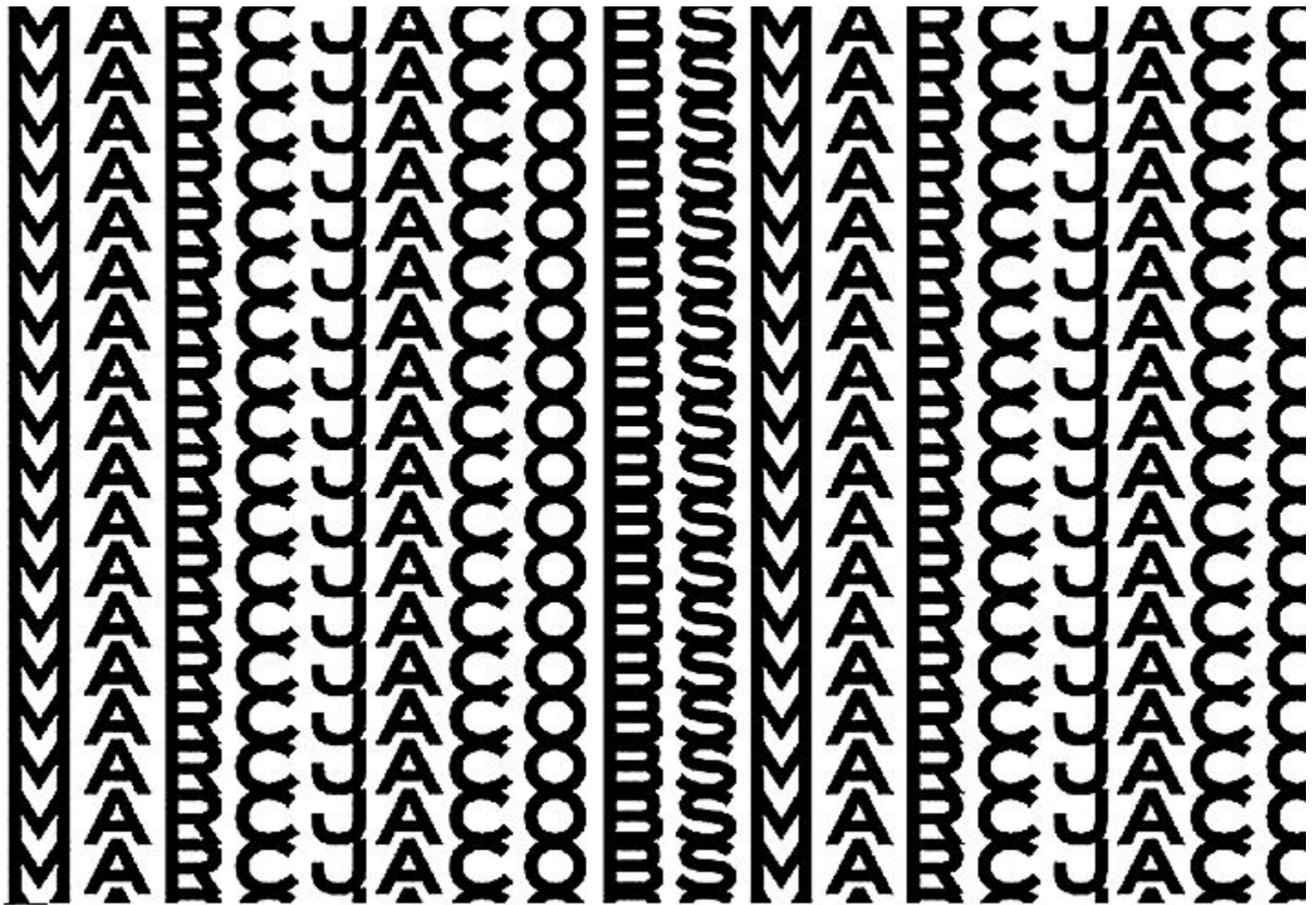

**Trademark Description**

The mark consists of a repeating pattern comprised of the name "MARC JACOBS" in stylized lettering.

**Authorisation For Use**

Consent from MARC JACOBS is of record.

**Goods****Class 18**

(1) Handbags; knapsacks; back packs; rucksacks; tote bags; beach bags; carry-all bags; satchels; clutch bags; shoulder bags; sling bags; purses; cosmetic bags sold empty; change purses; wallets; leather pouches; business card cases; credit card cases; toiletry cases sold empty; crossbody bags; traveling bags.

**Class 25**

(2) Clothing, namely, underwear, socks, hosiery, jerseys, shirts, t-shirts, blouses, sweaters, cardigan sweaters, pullovers, hoodies, sweatshirts, pants, jeans, shorts, dresses, skirts, blazers, jackets, coats, overcoats, waterproof clothing, namely, jackets and jumpsuits; bathing suits; belts; scarves; shawls; bandanas; waistcoats; pajamas; footwear, namely, shoes, boots, sandals and slippers; headwear, namely, hats and caps.

**Application Number** 2,165,490  
**International Registration Number** 1642884  
**Language of Application** English

**Filing Date** 2021-11-19

## APPLICANT AND AGENT DETAILS

### Applicant

Compass Mining, Inc.  
78 SW 7th Street, Suite 500  
Miami FL 33130  
UNITED STATES OF AMERICA

### Agent

MLT AIKINS LLP  
2100 Livingston Place, 222-3rd Avenue SW,  
Calgary, ALBERTA, T2P0B4

## TRADEMARK DETAILS

### Trademark Type

Design

### Visual Representation



### Trademark Description

The mark consists of the words COMPASS MINING stacked in a stylized font with a large letter "C" to the left of the words and a small arrow pointing diagonally upward to the right.

### Goods

#### Class 09

Computer hardware; computer hardware for data mining; computer hardware for virtual currency mining.

### Claims

Priority Filing Date: May 24, 2021, Country or Office: UNITED STATES OF AMERICA, Application No: 90730447 in association with the same kind of goods



**Application Number** 2,165,912  
**Language of Application** French

**Filing Date** 2022-02-10

## APPLICANT AND AGENT DETAILS

### Applicant

Clinique SOS Ostéo + inc.  
112-2120 Rue Sherbrooke E  
Montréal  
QUÉBEC  
H2K1C3

### Agent

TERRIEN COUTURE JOLI-COEUR S.E.N.C.  
R.L.  
1100, boul. René-Lévesque O., #2000,  
Montréal, QUÉBEC, H3B4N4

## TRADEMARK DETAILS

# SOS OSTEO+

### Trademark Type

Standard Characters

### Services

#### Class 44

physical therapy services; massage services; acupuncture services; occupational therapy services; osteopathy services; physiotherapy services

**Application Number** 2,168,628  
**International Registration Number** 1647012  
**Language of Application** English

**Filing Date** 2021-12-22

## **APPLICANT AND AGENT DETAILS**

### **Applicant**

The Children's Medical Center Corporation  
300 Longwood Avenue  
Boston MA 02115  
UNITED STATES OF AMERICA

### **Agent**

GOWLING WLG (CANADA) LLP  
SUITE 2600, 160 ELGIN STREET, OTTAWA,  
ONTARIO, K1P1C3

## **TRADEMARK DETAILS**

### **Trademark Type**

Design

### **Visual Representation**

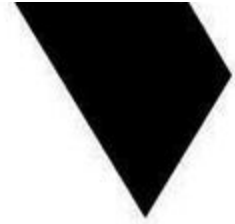
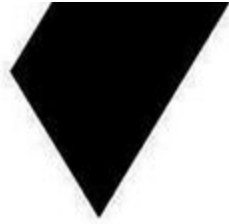

**Trademark Description**

The mark consists of an arrangement of five open triangles.

**Goods****Class 09**

Downloadable computer programs, namely, mobile device software, computer software development tools, application programming interface software, software development kits (SDK), database management software, downloadable data models, downloadable software designs, and downloadable software standards and specifications all for use in building, managing, structuring, encoding, storing, displaying, transmitting, and sharing verifiable health credentials, health records, healthcare information, health information, health-relevant information, biomedical data, clinical trials data, patient-generated and personally-generated health-relevant data, and information about healthcare providers and healthcare organizations, information about healthcare payment and payment organizations, and information about health and health care transactions.

**Claims**

Priority Filing Date: November 09, 2021, Country or Office: CHINA, Application No: 60393476 in association with the same kind of goods

**Application Number** 2,170,034  
**International Registration Number** 1647928  
**Language of Application** English

**Filing Date** 2021-11-19

## APPLICANT AND AGENT DETAILS

### Applicant

Compass Mining, Inc.  
78 SW 7th Street, Suite 500  
Miami FL 33130  
UNITED STATES OF AMERICA

### Agent

MLT AIKINS LLP  
2100 Livingston Place, 222-3rd Avenue SW,  
Calgary, ALBERTA, T2P0B4

## TRADEMARK DETAILS

# COMPASS MINING

### Trademark Type

Standard Characters

### Services

#### Class 42

Colocation services, namely, the provision of a secure environmentally-controlled facility and technical monitoring for the telecommunications equipment of others; hosting services, namely, for the mining of digital assets of others; data mining; data warehousing.

### Claims

Priority Filing Date: May 24, 2021, Country or Office: UNITED STATES OF AMERICA, Application No: 90730445 in association with the same kind of services

**Application Number** 2,172,541  
**Language of Application** English

**Filing Date** 2022-03-14

## APPLICANT AND AGENT DETAILS

### Applicant

DeVry Greenhouses (1989) Ltd.  
49259 Castleman Road  
Chilliwack  
BRITISH COLUMBIA  
V2P6H4

### Agent

OYEN WIGGS GREEN & MUTALA LLP  
480-THE STATION, 601 WEST CORDOVA  
STREET, VANCOUVER, BRITISH  
COLUMBIA, V6B1G1

## TRADEMARK DETAILS

### Trademark Type

Design

### Visual Representation

LETT'UCH  
GARDEN

**Colour Claim**

Colour is claimed as a feature of the trademark. The block letters of the design are in green and purple. The block letters "LETT" are in green, "UCE" are in purple, and "GARDEN" are in green.

**Goods****Class 31**

live plants

**Application Number** 2,172,952  
**Language of Application** French

**Filing Date** 2022-03-16

## APPLICANT DETAILS

### Applicant

Karima HABBOUT  
1332 Rue De Gascogne  
Québec  
QUÉBEC  
G1R1G6

## TRADEMARK DETAILS

# NatuKari

### Trademark Type

Standard Characters

### Goods

#### Class 03

natural cosmetics; organic cosmetics; cosmetics for use on the skin; cosmetics for body care; coconut oil-based cosmetics; cosmetics for personal use; bath soap; beauty soap; body care soap; body cream soap; body wash; skin soap; hand soap; dish soap; aloe soap; laundry soap

**Application Number** 2,173,445  
**Language of Application** French

**Filing Date** 2022-03-16

## APPLICANT DETAILS

### Applicant

Jeff Commerford  
1571 Tsse Lamarche  
J7L 3Y3  
Mascouche  
QUÉBEC  
J7L3Y3

## TRADEMARK DETAILS

# Vêtements Lust

### Trademark Type

Standard Characters

### Services

#### Class 35

retail sale of clothing; online sales of clothing



**Application Number** 2,174,051  
**Language of Application** French

**Filing Date** 2022-03-21

## APPLICANT DETAILS

### Applicant

Hugo Beaumont Tremblay  
1001 8E Av  
Shawinigan  
QUÉBEC  
G9T1Y8

## TRADEMARK DETAILS

# Yougo

### Trademark Type

Standard Characters

### Goods

#### Class 21

works of art made of glass

**Application Number** 2,174,240  
**Language of Application** French

**Filing Date** 2022-03-22

## APPLICANT AND AGENT DETAILS

### Applicant

FROMAGERIE BERGERON INC.  
3837 Rte Marie-Victorin  
Saint-Antoine-de-Tilly  
QUÉBEC  
G0S2C0

### Agent

STEPHANE LAMONDE  
(O'BRIEN AVOCATS), 140 GRANDE-ALLEE  
EST, BUREAU 600, QUEBEC, QUÉBEC,  
G1R5M8

## TRADEMARK DETAILS

# FROMAGE RENDEZ-VOUS

### Trademark Type

Standard Characters

### Goods

#### Class 29

cheese

**Application Number** 2,174,244  
**Language of Application** French

**Filing Date** 2022-03-22

## APPLICANT AND AGENT DETAILS

### Applicant

FROMAGERIE BERGERON INC.  
3837 Rte Marie-Victorin  
Saint-Antoine-de-Tilly  
QUÉBEC  
G0S2C0

### Agent

STEPHANE LAMONDE  
(O'BRIEN AVOCATS), 140 GRANDE-ALLEE  
EST, BUREAU 600, QUEBEC, QUÉBEC,  
G1R5M8

## TRADEMARK DETAILS

### Trademark Type

Design

### Visual Representation

CHEESE • FROMAGE  
**RENDEZ  
VOUS**

### Goods

Class 29

cheese

**Application Number** 2,174,245  
**Language of Application** French

**Filing Date** 2022-03-22

## APPLICANT AND AGENT DETAILS

### Applicant

FROMAGERIE BERGERON INC.  
3837 Rte Marie-Victorin  
Saint-Antoine-de-Tilly  
QUÉBEC  
G0S2C0

### Agent

STEPHANE LAMONDE  
(O'BRIEN AVOCATS), 140 GRANDE-ALLEE  
EST, BUREAU 600, QUEBEC, QUÉBEC,  
G1R5M8

## TRADEMARK DETAILS

# RENDEZ-VOUS CHEESE

### Trademark Type

Standard Characters

### Goods

**Class 29**

cheese

**Application Number** 2,175,026  
**Language of Application** English

**Filing Date** 2022-03-24

## APPLICANT AND AGENT DETAILS

### Applicant

ShelterLogic Corp.  
150 Callender Rd  
Watertown, CT 06795  
UNITED STATES OF AMERICA

### Agent

GOWLING WLG (CANADA) LLP  
SUITE 2600, 160 ELGIN STREET, OTTAWA,  
ONTARIO, K1P1C3

## TRADEMARK DETAILS

# SHELTERAUGER

### Trademark Type

Standard Characters

### Goods

#### Class 06

metal tent stakes; earth auger anchor kit; earth anchors

### Claims

Priority Filing Date: March 18, 2022, Country or Office: UNITED STATES OF AMERICA,  
Application No: 97319206 in association with the same kind of goods

**Application Number** 2,175,120  
**Language of Application** French

**Filing Date** 2022-03-24

## **APPLICANT DETAILS**

**Applicant**  
FROMAGERIE RANG 9 INC.  
766 9E Rang E  
Plessisville  
QUÉBEC  
G6L2Y2

## **TRADEMARK DETAILS**

# **LE PATERNEL**

**Trademark Type**  
Standard Characters

**Goods**  
**Class 29**  
cheese

**Application Number** 2,176,010  
**International Registration Number** 1652861  
**Language of Application** English

**Filing Date** 2021-08-11

## APPLICANT DETAILS

### Applicant

Entrata, Inc.  
4205 Chapel Ridge Rd.  
Lehi, UT 84043  
UNITED STATES OF AMERICA

## TRADEMARK DETAILS

### Trademark Type

Design

### Visual Representation

The image shows the word "entrata" in a bold, red, lowercase sans-serif font. The two "T" letters are stylized with square cutouts in their stems, and these square cutouts are also filled with red. The word is centered horizontally and occupies most of the width of the page.

### Trademark Description

The mark consists of the stylized word "ENTRATA" in red. Both "T" letters feature a square section that is "removed" for the bottom stem of the letters and is at the right of the letters. The square sections are also in red.

### Colour Claim

Colour is claimed as a feature of the trademark. The color(s) red is/are claimed as a feature of the mark. The mark consists of the stylized word "ENTRATA" in red. Both "T" letters feature a square section that is "removed" for the bottom stem of the letters and is at the right of the letters. The square sections are also in red.

### Foreign Character Translation

The translation provided by the applicant of the word ENTRATA is ENTRANCE and/or ENTRY.

### Goods

#### Class 09

Accounting software for use in the apartment rental industry for rental income accounting; computer software for use in database management of marketing budgets for rental apartments buildings; computer software for use in tracking repairs in apartment buildings for property

management companies; computer mobile applications for use in tenant management, namely, reviewing tenant qualifications, facilities maintenance management, and financial management of rented housing.

## **Services**

### **Class 35**

(1) Market research and market intelligence services; business consulting services in the field of business process improvement in connection with property management, namely, tenant management, tenant qualification, facilities management; resident referral services for rental properties; operation of telephone call centers for others.

### **Class 36**

(2) Insurance brokerage in the field of renters' insurance; electronic payment services involving electronic processing and subsequent transmission of bill payment data; real estate listing services for housing rentals and apartment rentals.

### **Class 41**

(3) Providing training in the use of computer software; educational services, namely, conducting training seminars regarding computer software specific to the needs of property management companies; educational services, namely, providing non-downloadable webinars in the fields of real estate management.

### **Class 42**

(4) Providing online non-downloadable computer software for use in database management of information related to the maintenance of apartment units, rental properties, and a listing of the tenants of those units and properties; custom design of computer software; software as a service (SAAS) services featuring software for automating the management, accounting, renting, leasing for owners or managers of multifamily housing, and hosting interactive software for use by others to allow tenants of apartment complexes and other communities to submit service and maintenance requests, request common area reservations, and communicate with the landlord and other tenants; consultation services in the field of computer system configuration and computer software development.



**Application Number** 2,176,123  
**International Registration Number** 1653345  
**Language of Application** English

**Filing Date** 2021-11-19

## APPLICANT AND AGENT DETAILS

### Applicant

Compass Mining, Inc.  
78 SW 7th Street, Suite 500  
Miami FL 33130  
UNITED STATES OF AMERICA

### Agent

MLT AIKINS LLP  
2100 Livingston Place, 222-3rd Avenue SW,  
Calgary, ALBERTA, T2P0B4

## TRADEMARK DETAILS

### Trademark Type

Design

### Visual Representation



### Trademark Description

The mark consists of the words COMPASS MINING stacked in a stylized font with a large letter "C" to the left of the words and a small arrow pointing diagonally upward to the right.

### Services

#### Class 42

Colocation services, namely, providing secure environmentally-controlled facilities, for the hosting and storage of computer and cryptocurrency servers of others, and technical monitoring of the functioning and use of computer and cryptocurrency servers; hosting services, namely, providing data centers to facilitate the mining of cryptocurrency of others; data mining; data warehousing.

### Claims

Priority Filing Date: May 24, 2021, Country or Office: UNITED STATES OF AMERICA, Application No: 90730450 in association with the same kind of services

**Application Number** 2,180,175  
**Language of Application** English

**Filing Date** 2022-04-20

## APPLICANT AND AGENT DETAILS

### Applicant

Home Depot International, Inc.  
2455 Paces Ferry Road, NW  
Atlanta, GA 30339  
UNITED STATES OF AMERICA

### Agent

BERESKIN & PARR LLP/S.E.N.C.R.L., S.R.L.  
SCOTIA PLAZA, 40 KING STREET WEST,  
40th FLOOR, TORONTO, ONTARIO, M5H3Y2

## TRADEMARK DETAILS

# HAMPTON BAY

### Trademark Type

Standard Characters

### Goods

#### Class 06

(1) Miter joint fasteners

#### Class 09

(2) motion sensors

#### Class 20

(3) Decorative wooden sign boards and wall plaques made of wood

**Application Number** 2,180,176  
**Language of Application** English

**Filing Date** 2022-04-20

## APPLICANT AND AGENT DETAILS

### Applicant

Home Depot International, Inc.  
2455 Paces Ferry Road, NW  
Atlanta, GA 30339  
UNITED STATES OF AMERICA

### Agent

BERESKIN & PARR LLP/S.E.N.C.R.L., S.R.L.  
SCOTIA PLAZA, 40 KING STREET WEST,  
40th FLOOR, TORONTO, ONTARIO, M5H3Y2

## TRADEMARK DETAILS

### Trademark Type

Design

### Visual Representation



### Goods

#### Class 06

(1) Miter joint fasteners

#### Class 09

(2) motion sensors

#### Class 20

(3) Decorative wooden sign boards and wall plaques made of wood

**Application Number** 2,181,093  
**Language of Application** French

**Filing Date** 2022-04-22

## APPLICANT DETAILS

### Applicant

9442-3696 Que bec Inc.  
7111 19e avenue  
Montréal  
QUÉBEC  
H2A2L4

## TRADEMARK DETAILS

# Devil Studios

### Trademark Type

Standard Characters

### Goods

#### Class 09

downloadable printable place cards; video games; computer video games; video games and downloadable video game software; computer games downloadable from a global computer network; computer video games downloaded via the internet; downloadable interactive video games; downloadable video games; computer games for use on notebook computers; video games on disc; computer application software in playing video and computer games; downloadable computer application software for playing video games; computer software for operating computer games on the internet; downloadable interactive entertainment software for playing computer games; downloadable interactive entertainment software for playing video games; computer game programmes; computer game software for use on mobile and cellular phones; computer game software, recorded or downloadable; video game software; interactive entertainment computer software for video games; recorded computer gaming software for gambling; interactive computer game programs; downloadable computer game programs; computer game programs downloadable via the Internet; virtual reality computer game programs; downloadable interactive multimedia computer game programs for playing video and computer games; interactive multimedia computer game programs; video game programs; video and computer game programs; downloadable video game programs; electronic game programs; downloadable computer programs for video and computer games

### Services

#### Class 41

(1) production of video games; publishing of electronic games; publishing of video game software; publishing of computer game software

#### Class 42

(2) development of computer games; development of video and computer games; computer programming of computer games; computer programming of video games; video game development services

**Application Number** 2,181,375  
**Language of Application** French

**Filing Date** 2022-04-25

## APPLICANT DETAILS

### Applicant

Créations Capucino inc.  
1103 rue du marché  
ACTON VALE  
QUÉBEC  
J0H1A0

## TRADEMARK DETAILS

### Trademark Type

Design

### Visual Representation



**Colour Claim**

Colour is claimed as a feature of the trademark. "100%" is light grey (#d4cdc 8), the rectangle is dark grey (#2b2b2b), "Redneck" is green (#7ED 957).

**Goods****Class 25**

athletic apparel; bandannas; bandeaux; stockings; bikini bottoms; swimming suit bottoms; bikini; bikinis; blazers; sweat jackets; blue jeans; beanies; knot caps; bobble hats; toboggan hats; boxer shorts; brassieres; braces [suspenders]; trouser braces; straps for brassieres; shoe straps; bustiers; tube tops; neck warmers; pants; swimming trunks; trekking pants; hiking pants; trunk briefs; camisoles; caps; sports caps; sports caps and hats; promotional caps; belts; leather belts; belts made of leather; belts made from imitation leather; belts of textile; waistbands; sweater; sweaters; team shirts; sports jerseys and breeches for sports; open-necked shirts; cotton sweaters; fleece pullovers; hooded sweat shirts; sweatshirts, sweat pants, t-shirts, shorts, coats, jackets, polo shirts and knit tops; pique shirts; hoodies; henley shirts; turtleneck sweaters; long sleeve pullovers; chaps; socks; non-slip socks; socks and stockings; men's suits; bathing suits; windcheaters; wind resistant jackets; knickers; thong underwear; jacket liners; slipovers; scrimmage vests; sports singlets; vests; camouflage vests; hunting vests; fishing tackle vests; birding vests; long sleeved vests; snowmobile suits; crop tops; sweat tops; bikini tops; vest tops; athletic tops; warm-up tops; fleece vests; fleece tops; hooded tops; denim pants; denim jeans; jerseys; bathing suits; fitted swimming costumes with bra cups; bathing suits for women; bathing costumes for women; one-piece bathing suits; coats; wind-jackets; wind resistant jackets; greatcoats; winter coats; beach coats; raincoats; evening coats; coats made of cotton; coats of denim; coats of denim; coats for women; coats for men and women; coats for men; sports coats; heavy coats; bow ties; denim capris; tracksuit pants; pants; capri pants; cargo pants; wind pants; short pants; cargo crops; denim crop pants; athletic pants; sweat pants; snow pants; camouflage pants; hunting pants; lounge pants; jogging pants; snow pants; snowboard trousers; sports pants; casual trousers; jersey pants; sweatpants; stretch pants; dress pants; ankle-length pants; fleece

pants; rain trousers; casual pants; parkas; parkas, jackets, coats, and vests; panties; pockets for clothing; pocket squares; garter belts; mock turtleneck shirts; hooded pullovers; long-sleeved sweaters; sweatshirts; hooded sweatshirts; fleece shirts; sleeveless pullovers; mock turtleneck sweaters; crew neck sweaters; frocks; sundresses; housecoats; cocktail dresses; evening dresses; denim dresses; dresses and gowns; tube dresses; bags for sneakers; bags specially adapted for hunting boots; bib overalls; sandals; bath sandals; beach sandals; sandals and beach shoes; men's sandals; thong sandals; wrist bands; waist cinchers; hair bands; head bands; boy shorts; shorts; athletic shorts; cargo shorts; swim shorts; running shorts; walking shorts; sweat shorts; denim shorts; gym shorts; briefs; bikini briefs; tuxedos; underwear; union suits; maternity underwear; intimate apparel; children's underwear; women's underwear; men's underwear; woven underwear; sports bra; bras; moisture-wicking sports bras; nursing bras; sports bras; moisture-wicking sports bras; bralettes; strapless bras; bras, panties, underwear, undergarments, hosiery; lightweight sweaters; baby sweaters; t-shirts; graphic t-shirts; printed t-shirts; promotional t-shirts; skirt suits; ladies' suits; pant suits; trouser suits for women; tee-shirts; long-sleeved t-shirts; t-shirts, sweat shirts and sweat pants; gym suits; loungewear; playsuits; jogging suits; flip-flops for use as footwear; tuques; sleeved jackets; shirt-jacs; shell jackets; wind resistant jackets; outerwear jackets; winter jackets; camouflage jackets; hunting jackets; beach jackets; fishermen's jackets; fishing vests; hiking jackets; track jackets; denim jackets; jean jackets; rain jackets; long jackets; lightweight jackets; fleece jackets; reversible jackets; bomber vests; sport jackets; hooded jackets; short-sleeved jackets; long-sleeved jackets; jackets, coats, and vests; smoking jackets; suit vests; sport coats; camouflage clothing for hunting; loungewear; leisurewear; maternity wear; dress clothing; casual clothing; sports clothing; casual wear; convertible clothing in the nature of a dress; convertible clothing in the nature of hooded sweatshirts

**Application Number** 2,181,426  
**Language of Application** French

**Filing Date** 2022-04-25

## APPLICANT DETAILS

### Applicant

Damien, Frédéric Andre  
1700 Rue Galt  
H4E1J2  
Montréal  
QUÉBEC  
H4E1J2

## TRADEMARK DETAILS

# DAF

### Trademark Type

Standard Characters

### Goods

#### Class 30

coffee flavourings; coffee-based beverages; coffee beverages with milk; coffee-based beverages containing marijuana; coffee-based beverages containing cannabinoids; coffee-based beverages containing derivatives of marijuana; coffee-based beverages containing derivatives of cannabis; coffee-based beverages containing cannabis; beverages made of coffee; coffee-based beverages; coffee; coffee, ground coffee, coffee beans; coffee beverages with milk; coffee concentrate; caffeine-free coffee; powdered coffee in drip bags; coffee and artificial coffee; coffee and coffee substitutes; coffee and tea; iced coffee; instant coffee; ground coffee; unroasted coffee; roasted coffee; prepared coffee and coffee-based beverages; coffee, green coffee beans, roasted coffee beans and coffee based beverages; coffee capsules; coffee capsules containing coffee for brewing; coffee capsules, filled; chicory and chicory mixtures for use as coffee substitutes; coffee pods; barley coffee pods, filled; coffee essences; coffee essences for use as substitutes for coffee; coffee extracts; coffee extracts for use as substitutes for coffee; coffee beans; chocolate-coated coffee beans; sugar-coated coffee beans; granulated coffee for drinks; ground coffee beans; roasted coffee for drinks; roasted coffee beans; coffee-based beverage mix; mixtures of coffee and chicory; coffee filter bags, filled; coffee syrups; chocolate bark containing ground coffee beans

### Services

#### Class 35

(1) wholesale distributorship services for tea and coffee; on-line wholesale store services featuring coffee; retail services for coffee; on-line retail store services featuring coffee

#### Class 43

(2) coffee supply services; coffee shops; cafe-restaurants; coffee supply services for offices; coffee and tea bar services; mobile cafe services for providing food and drink; coffee-house and snack-bar services; café services; cafe and restaurant services; café and snack-bar services; coffee shop services; restaurant and café services; restaurant, bar and cafe services



**Application Number** 2,181,534  
**Language of Application** English

**Filing Date** 2022-04-26

## APPLICANT AND AGENT DETAILS

### Applicant

The Procter & Gamble Company  
One Procter & Gamble Plaza  
Cincinnati, OH 45202  
UNITED STATES OF AMERICA

### Agent

WILSON LUE LLP  
250 University Avenue, 5th Floor, Toronto,  
ONTARIO, M5H3E5

## TRADEMARK DETAILS

# ALWAYS PROTECTING TOMORROW TOGETHER

### Trademark Type

Standard Characters

### Goods

#### Class 05

feminine hygiene pads; menstruation pads; panty liners and sanitary pads

**Application Number** 2,181,551  
**Language of Application** French

**Filing Date** 2022-04-26

## APPLICANT AND AGENT DETAILS

**Applicant**  
EMBOUTEILLAGE CANADA INC.  
169 Rue Sainte-Claire  
Saguenay  
QUÉBEC  
G7G2S4

**Agent**  
ROBIC  
630, boul. René-Lévesque Ouest, 20e étage,  
Montréal, QUÉBEC, H3B1S6

## TRADEMARK DETAILS

**Trademark Type**  
Design

**Visual Representation**



**Colour Claim**

Colour is claimed as a feature of the trademark. The colours red and white are claimed as features of the mark. The design consists of a red tomato with the term QUETCHUP in white on the inside.

**Goods****Class 30**

ketchup

**Application Number** 2,181,636  
**Language of Application** French

**Filing Date** 2022-04-26

## APPLICANT DETAILS

### Applicant

Cédric Harnois  
10 Av Broadway  
Montréal-Est  
QUÉBEC  
H1B4Z6

## TRADEMARK DETAILS

### Trademark Type

Design

### Visual Representation



### Colour Claim

Colour is claimed as a feature of the trademark. The monkey is red (HEX: #c21e1e; R: 194, G: 30, B: 30; C: 0, M: 85, Y: 85, K: 24). The disc behind the monkey is black (HEX: #212327; R: 33, G: 35, B: 39; C: 15, M: 10, Y: 0, K: 85). The circle surrounding the monkey is red (HEX: #c21e1e; R: 194, G: 30, B: 30; C: 0, M: 85, Y: 85, K: 24). The term "NFGear" is black (HEX: #212327; R: 33, G: 35, B: 39; C: 15, M: 10, Y: 0, K: 85), and the outline of the letters forming "NFGear" is red (HEX; RGBA: 194, 30, 30, 1; R: 0, G: 0, B: 0; C: 0, M: 0, Y: 0, K: 100).

### Goods

#### Class 25

sweatshirts, sweat pants, t-shirts, shorts, coats, jackets, polo shirts and knit tops

### Services

#### Class 35

retail clothing boutiques

**Application Number** 2,182,121  
**International Registration Number** 1658017  
**Language of Application** French

**Filing Date** 2022-03-03

## APPLICANT DETAILS

**Applicant**  
L'OREAL  
14 rue Royale  
F-75008 PARIS  
FRANCE

## TRADEMARK DETAILS

# CHROMA CREME

**Trademark Type**  
Standard Characters

### Goods

#### Class 03

Hair care preparations other than for medical use; hair styling preparations; hair coloring and bleaching preparations.

### Claims

Priority Filing Date: September 09, 2021, Country or Office: FRANCE, Application No: 4798233 in association with the same kind of goods

**Application Number** 2,182,508  
**Language of Application** French

**Filing Date** 2022-04-28

## **APPLICANT DETAILS**

### **Applicant**

11266918 Canada Inc  
7194 Boulevard Wilfrid Hamel Ouest  
Québec  
QUÉBEC  
G2G1B7

## **TRADEMARK DETAILS**

# **FIDOBOS**

### **Trademark Type**

Standard Characters

### **Goods**

#### **Class 18**

dog boots; dog shoes; dog collars; dog collars and leads; harness for dogs; dog leashes; raincoats for pet dogs; dog coats; rawhide chews for dogs

**Application Number** 2,183,093  
**Language of Application** French

**Filing Date** 2022-05-03

## APPLICANT DETAILS

### Applicant

Bunny Bum  
122 Rue De La Roseaie  
Shefford  
QUÉBEC  
J2M1L7

## TRADEMARK DETAILS

# Pinpins & cocktails

### Trademark Type

Standard Characters

### Services

#### Class 41

(1) educational services in the field of pet care

#### Class 45

(2) animal rescue services, namely, arranging for the adoption of rescued animals

**Application Number** 2,183,266  
**Language of Application** French

**Filing Date** 2022-05-04

## APPLICANT DETAILS

### Applicant

Mouches neptune  
350 7E Rang  
Sainte-Mélanie  
QUÉBEC  
J0K3A0

## TRADEMARK DETAILS

# Buglce

**Trademark Type**  
Standard Characters

### Goods

#### Class 28

artificial bait for fishing; fishing tackle; fishing lures



**Application Number** 2,184,233  
**Language of Application** English

**Filing Date** 2022-05-07

## APPLICANT AND AGENT DETAILS

### Applicant

Yunjing Intelligence Technology (Dongguan)  
Co.,Ltd.  
Building 7, No.4 Xingye Rd., SongShanLake  
Park  
Dongguan, Guangdong, 523000  
CHINA

### Agent

MARK W. TIMMIS  
(MARK TIMMIS LAW CORPORATION), 2595  
CAVENDISH AVENUE, VICTORIA, BRITISH  
COLUMBIA, V8R2G5

## TRADEMARK DETAILS

### Trademark Type

Design

### Visual Representation

**N A R W A L**  
**F R E O**

### Goods

#### Class 07

floor washing machines; Garbage disposal units; carpet cleaning machines; central vacuum cleaning installations; wet-and-dry vacuum cleaners; vacuum cleaner attachments; vacuum cleaners; vacuum cleaner bags; brushes for vacuum cleaners; food garbage disposals; handheld vacuum cleaners; cordless vacuum cleaners; electric vacuum cleaners; floor polishing machines; carpet shampoos; electric window cleaning machines; Floor scrubbing machines.

**Application Number** 2,184,347  
**Language of Application** French

**Filing Date** 2022-05-09

## APPLICANT AND AGENT DETAILS

### Applicant

Markefin inc.  
9155 Av San-Francisco  
Brossard  
QUÉBEC  
J4X2K1

### Agent

TERRIEN COUTURE JOLI-COEUR S.E.N.C.  
R.L.  
1100, boul. René-Lévesque O., #2000,  
Montréal, QUÉBEC, H3B4N4

## TRADEMARK DETAILS

# MARKEFIN

### Trademark Type

Standard Characters

### Services

#### Class 35

(1) commercial assistance in business management; assistance and advice regarding business organization and management; business management consultancy services; development of marketing strategies and concepts for others; business consulting in the field of business acquisitions and mergers; advisory services relating to business planning; business intermediary services relating to the matching of potential private investors with entrepreneurs needing funding; business appraisals and evaluations in business matters

#### Class 36

(2) mortgage brokerage; financing of acquisitions; real estate financing; financial asset management; financial advisory services relating to business acquisitions and mergers; financial structuring services relating to business acquisitions and mergers; mortgage services

**Application Number** 2,184,396  
**Language of Application** French

**Filing Date** 2022-05-09

## APPLICANT DETAILS

### Applicant

Salim Ouedraogo  
260 rue saint charles  
la prairie  
QUÉBEC  
J5r2n7

## TRADEMARK DETAILS

### Trademark Type

Design

### Visual Representation



### Goods

#### Class 25

athletic tops; yoga tops; sports bra; sports overuniforms; jogging suits; athletic clothing; athletic wear; exercise wear; clothing for athletic use, namely, shorts

**Application Number** 2,184,596  
**Language of Application** French

**Filing Date** 2022-05-10

## APPLICANT AND AGENT DETAILS

### Applicant

Vidéotron Ltée  
612, rue Saint-Jacques  
Montréal  
QUÉBEC  
H3C4M8

### Agent

FASKEN MARTINEAU DUMOULIN LLP  
Tour de la Bourse, Suite 3500, P.O. box 242,  
800, Place Victoria, Montréal, QUÉBEC,  
H4Z1E9

## TRADEMARK DETAILS

# ON SE COMPREND

### Trademark Type

Standard Characters

### Goods

#### Class 09

optical fiber telecommunications apparatus; mobile telecommunications handsets; set-top boxes; downloadable software for the home automation of electric control systems for kitchen appliances; downloadable software for the home automation of electric control systems for electrical power switches; downloadable software for the home automation of electric control systems for lighting; downloadable software for the home automation of electric control systems for home security systems; computer hardware for telecommunications; receivers for receiving cable television; terminal connectors for telecommunication lines

### Services

#### Class 36

(1) financing of purchases; lease-purchase financing services; bill payment services provided through a web site

#### Class 38

(2) broadcasting of cable television programmes; broadcasting of films and television programmes via a video-on-demand service; operation of a cellular phone network; internet service provider (ISP) services; cable television provider services by means of fibre optic cables, telephone lines, radio and microwave transmission, satellite transmission; provision of telecommunication access to films and television programs provided via a video-on-demand service; providing multiple-user wireless access to the Internet; providing access to Internet chatrooms; providing access to Internet forums; providing access to mobile Internet platforms; providing access to mobile Internet portals; providing access to digital music websites on the internet; providing telecommunications connections to the Internet in a cafe environment; providing access to mp3 web sites on the internet; providing access to a website that provides streaming of digital recorded music, not downloadable, from the internet; radio and television broadcasting services; telephone services and teletext services; fixed and mobile telephone services; prepaid local and long distance

telephone services; internet telephony services; telecommunication bundle services that allow customers to reach cellular phones, voicemail and call routing between wireline and wireless phones and voicemail boxes

**Class 41**

(3) entertainment in the form of boxing matches; entertainment services in the nature of non-downloadable television shows and movies transmitted via the internet; providing television programmes, not downloadable, via video-on-demand transmission services; arranging and conducting performances featuring live music; production of live musical variety shows; presentation of live comedy shows; entertainment in the nature of hockey games; event planning services

**Application Number** 2,184,608  
**Language of Application** French

**Filing Date** 2022-05-10

## APPLICANT AND AGENT DETAILS

### Applicant

Vidéotron Ltée  
612, rue Saint-Jacques  
Montréal  
QUÉBEC  
H3C4M8

### Agent

FASKEN MARTINEAU DUMOULIN LLP  
Tour de la Bourse, Suite 3500, P.O. box 242,  
800, Place Victoria, Montréal, QUÉBEC,  
H4Z1E9

## TRADEMARK DETAILS

# WE GET IT

### Trademark Type

Standard Characters

### Goods

#### Class 09

optical fiber telecommunications apparatus; mobile telecommunications handsets; set-top boxes; downloadable software for the home automation of electric control systems for kitchen appliances; downloadable software for the home automation of electric control systems for electrical power switches; downloadable software for the home automation of electric control systems for lighting; downloadable software for the home automation of electric control systems for home security systems; computer hardware for telecommunications; receivers for receiving cable television; terminal connectors for telecommunication lines

### Services

#### Class 36

(1) financing of purchases; lease-purchase financing services; bill payment services provided through a web site

#### Class 38

(2) broadcasting of cable television programmes; broadcasting of films and television programmes via a video-on-demand service; operation of a cellular phone network; internet service provider (ISP) services; cable television provider services by means of fibre optic cables, telephone lines, radio and microwave transmission, satellite transmission; provision of telecommunication access to films and television programs provided via a video-on-demand service; providing multiple-user wireless access to the Internet; providing access to Internet chatrooms; providing access to Internet forums; providing access to mobile Internet platforms; providing access to mobile Internet portals; providing access to digital music websites on the internet; providing telecommunications connections to the Internet in a cafe environment; providing access to mp3 web sites on the internet; providing access to a website that provides streaming of digital recorded music, not downloadable, from the internet; radio and television broadcasting services; telephone services and teletext services; fixed and mobile telephone services; prepaid local and long distance

telephone services; internet telephony services; telecommunication bundle services that allow customers to reach cellular phones, voicemail and call routing between wireline and wireless phones and voicemail boxes

**Class 41**

(3) entertainment in the form of boxing matches; entertainment services in the nature of non-downloadable television shows and movies transmitted via the internet; providing television programmes, not downloadable, via video-on-demand transmission services; arranging and conducting performances featuring live music; production of live musical variety shows; presentation of live comedy shows; entertainment in the nature of hockey games; event planning services

**Application Number** 2,185,457  
**Language of Application** English

**Filing Date** 2022-05-12

## APPLICANT AND AGENT DETAILS

### Applicant

Happy Day Gourmet, LLC  
3232 South 400 East  
Suite 800  
Salt Lake City, UT 84115  
UNITED STATES OF AMERICA

### Agent

BERESKIN & PARR LLP/S.E.N.C.R.L., S.R.L.  
SCOTIA PLAZA, 40 KING STREET WEST,  
40th FLOOR, TORONTO, ONTARIO, M5H3Y2

## TRADEMARK DETAILS

# SHARK FINS

### Trademark Type

Standard Characters

### Goods

#### Class 30

salty snacks, namely, popcorn; pretzels; corn puffs and crackers

### Claims

Priority Filing Date: April 12, 2022, Country or Office: UNITED STATES OF AMERICA, Application No: 97359255 in association with the same kind of goods



**Application Number** 2,185,458  
**Language of Application** English

**Filing Date** 2022-05-12

## APPLICANT AND AGENT DETAILS

### Applicant

Happy Day Gourmet, LLC  
3232 South 400 East  
Suite 800  
Salt Lake City, UT 84115  
UNITED STATES OF AMERICA

### Agent

BERESKIN & PARR LLP/S.E.N.C.R.L., S.R.L.  
SCOTIA PLAZA, 40 KING STREET WEST,  
40th FLOOR, TORONTO, ONTARIO, M5H3Y2

## TRADEMARK DETAILS

# TIE DYE PUFFS

### Trademark Type

Standard Characters

### Goods

#### Class 30

salty snacks, namely, popcorn; pretzels; corn-based snack foods and crackers

### Claims

Priority Filing Date: May 12, 2022, Country or Office: UNITED STATES OF AMERICA, Application No: 97407124 in association with the same kind of goods

**Application Number** 2,185,460  
**Language of Application** English

**Filing Date** 2022-05-12

## APPLICANT AND AGENT DETAILS

### Applicant

Happy Day Gourmet, LLC  
3232 South 400 East  
Suite 800  
Salt Lake City, UT 84115  
UNITED STATES OF AMERICA

### Agent

BERESKIN & PARR LLP/S.E.N.C.R.L., S.R.L.  
SCOTIA PLAZA, 40 KING STREET WEST,  
40th FLOOR, TORONTO, ONTARIO, M5H3Y2

## TRADEMARK DETAILS

# UNICORN HORNS

### Trademark Type

Standard Characters

### Goods

#### Class 30

salty snacks, namely, pretzels; corn puffs and crackers

### Claims

Priority Filing Date: May 12, 2022, Country or Office: UNITED STATES OF AMERICA, Application No: 97407118 in association with the same kind of goods

**Application Number** 2,186,035  
**Language of Application** English

**Filing Date** 2022-05-17

## APPLICANT AND AGENT DETAILS

### Applicant

Gerbrands Medical Prof. Corp.  
1500-1874 Scarth St  
Regina  
SASKATCHEWAN  
S4P4E9

### Agent

FURMAN IP LAW & STRATEGY PC  
300 - 1914 HAMILTON STREET, REGINA,  
SASKATCHEWAN, S4P3N6

## TRADEMARK DETAILS

# DE HAAR HAIR RESTORATION

### Trademark Type

Standard Characters

### Foreign Character Translation

The translation provided by the applicant of the words DE HAAR is a hair.

### Goods

#### Class 03

(1) Hair care preparations; hair removal preparations

#### Class 05

(2) Hair growth preparations

### Services

#### Class 44

Cosmetic laser treatment for hair growth; Cosmetic laser treatment for removal of unwanted hair; Hair transplantation; Hair implantation, Non-surgical hair loss treatments; Hair Restoration services; Hair Replacement services; Platelet rich plasma therapy combined with micro needling for hair loss and hair rejuvenation, Hair growth preparations combined with micro needling for hair loss and hair rejuvenation; Cosmetic laser treatment for hair loss and hair rejuvenation; Micropigmentation for hair loss.

**Application Number** 2,186,081  
**Language of Application** English

**Filing Date** 2022-05-17

## **APPLICANT AND AGENT DETAILS**

### **Applicant**

Legend Fleet Solutions Inc.  
56957 Hwy 3 West  
Tillsonburg  
ONTARIO  
N4G4G8

### **Agent**

KEYSER MASON BALL, LLP  
900 - 3 Robert Speck Parkway, Mississauga,  
ONTARIO, L4Z2G5

## **TRADEMARK DETAILS**

# **LEGEND STABILIGRIP**

### **Trademark Type**

Standard Characters

### **Goods**

#### **Class 27**

anti-slip floor mats; floor mats for vehicles

**Application Number** 2,186,082  
**Language of Application** English

**Filing Date** 2022-05-17

## APPLICANT AND AGENT DETAILS

### Applicant

Legend Fleet Solutions Inc.  
56957 Hwy 3 West  
Tillsonburg  
ONTARIO  
N4G4G8

### Agent

KEYSER MASON BALL, LLP  
900 - 3 Robert Speck Parkway, Mississauga,  
ONTARIO, L4Z2G5

## TRADEMARK DETAILS

# LEGEND EVOLVE

### Trademark Type

Standard Characters

### Goods

#### Class 27

anti-slip floor mats; floor mats for vehicles

**Application Number** 2,186,953  
**Language of Application** English

**Filing Date** 2022-05-19

## APPLICANT AND AGENT DETAILS

### Applicant

Skyjack Inc.  
201 Woodlawn Road West  
Guelph  
ONTARIO  
N1H1B8

### Agent

RIDOUT & MAYBEE LLP  
11 Holland Avenue, Suite 601 , Ottawa,  
ONTARIO, K1Y4S1

## TRADEMARK DETAILS

### Trademark Type

Position

### Visual Representation

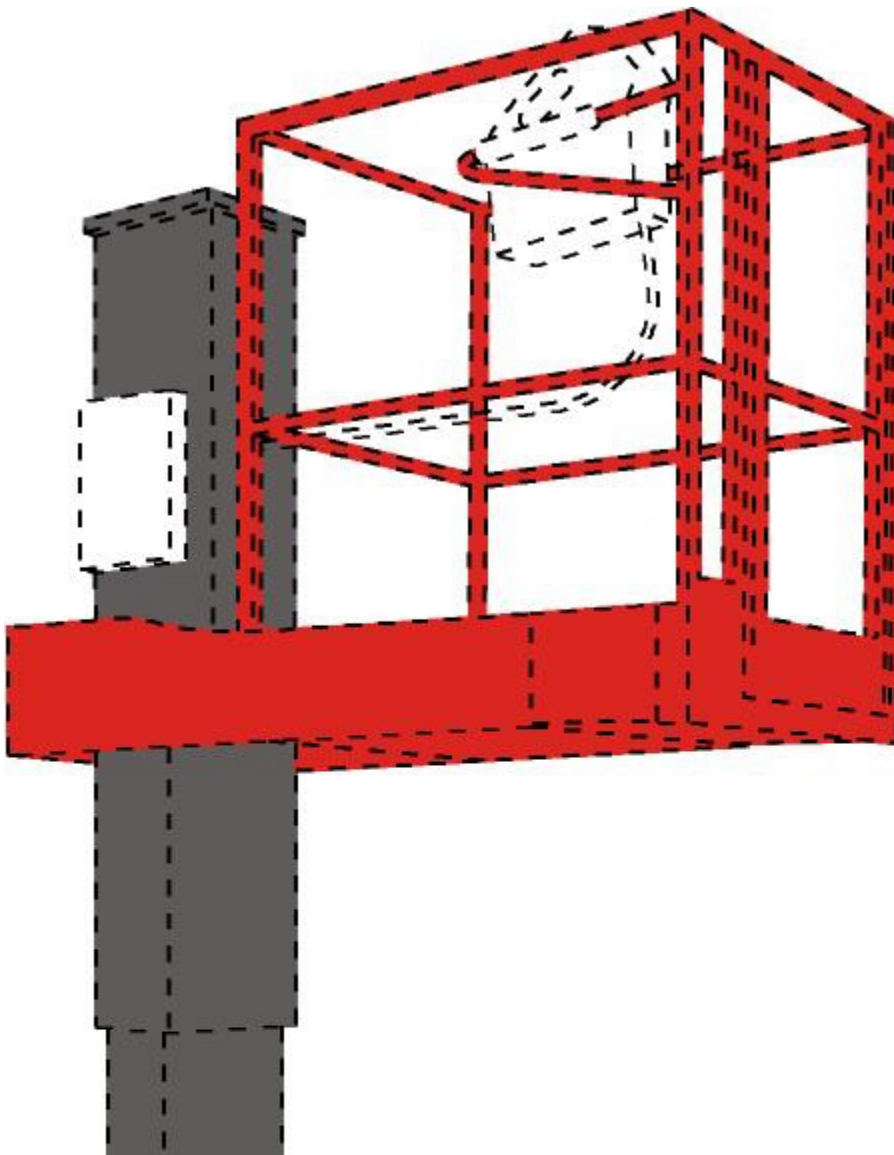

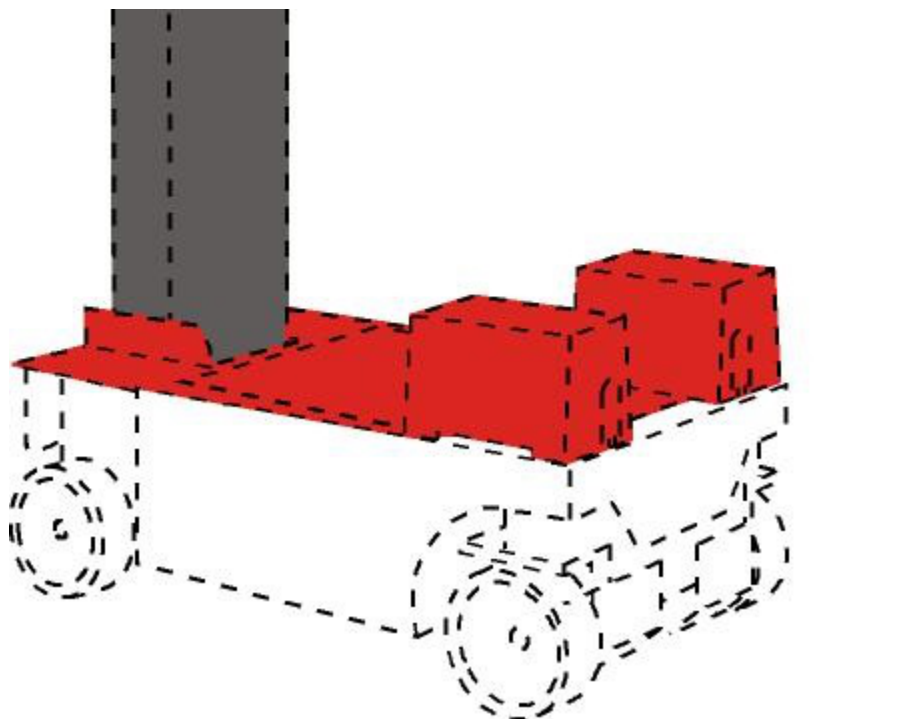

### **Trademark Description**

The trademark consists of the position of the colours orange and grey as applied to portions of the visible surface of a three-dimensional vertical mast lift, as shown in the visual representation. The portions of the vertical mast lift shown in dashed outlines do not form part of the trademark and show the position or placement of the trademark on the goods.

### **Colour Claim**

Colour is claimed as a feature of the trademark. The trademark consists of the colour combination of orange and grey in which orange is applied to the base, platform, and basket and grey is applied to the mast.

### **Goods**

#### **Class 07**

Aerial work platforms

### **Claims**

Priority Filing Date: May 18, 2022, Country or Office: UNITED STATES OF AMERICA, Application No: 97/415,984 in association with the same kind of goods

**Application Number** 2,186,957  
**Language of Application** English

**Filing Date** 2022-05-19

## APPLICANT AND AGENT DETAILS

### Applicant

Skyjack Inc.  
201 Woodlawn Road West  
Guelph  
ONTARIO  
N1H1B8

### Agent

RIDOUT & MAYBEE LLP  
11 Holland Avenue, Suite 601 , Ottawa,  
ONTARIO, K1Y4S1

## TRADEMARK DETAILS

### Trademark Type

Position

### Visual Representation

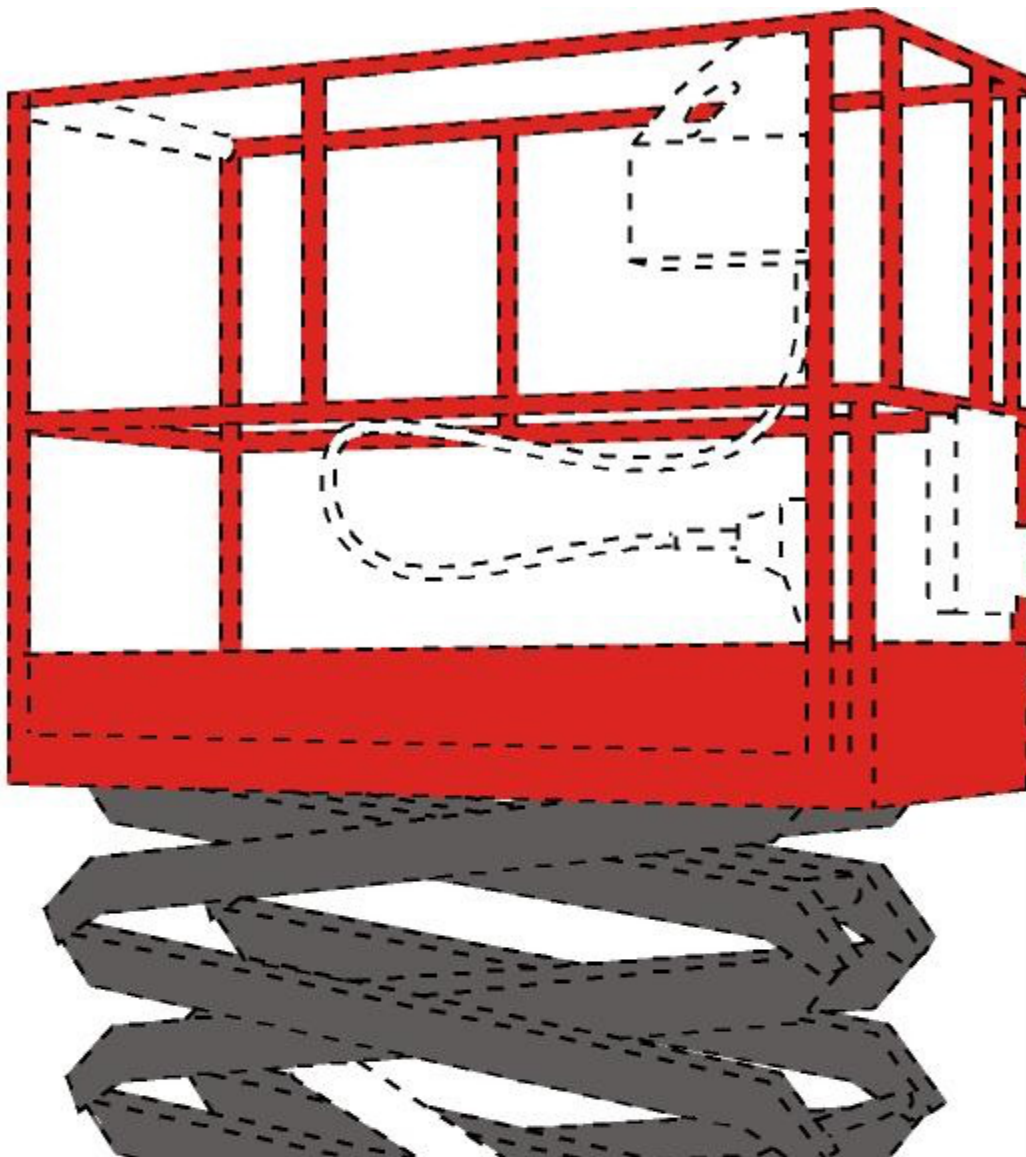

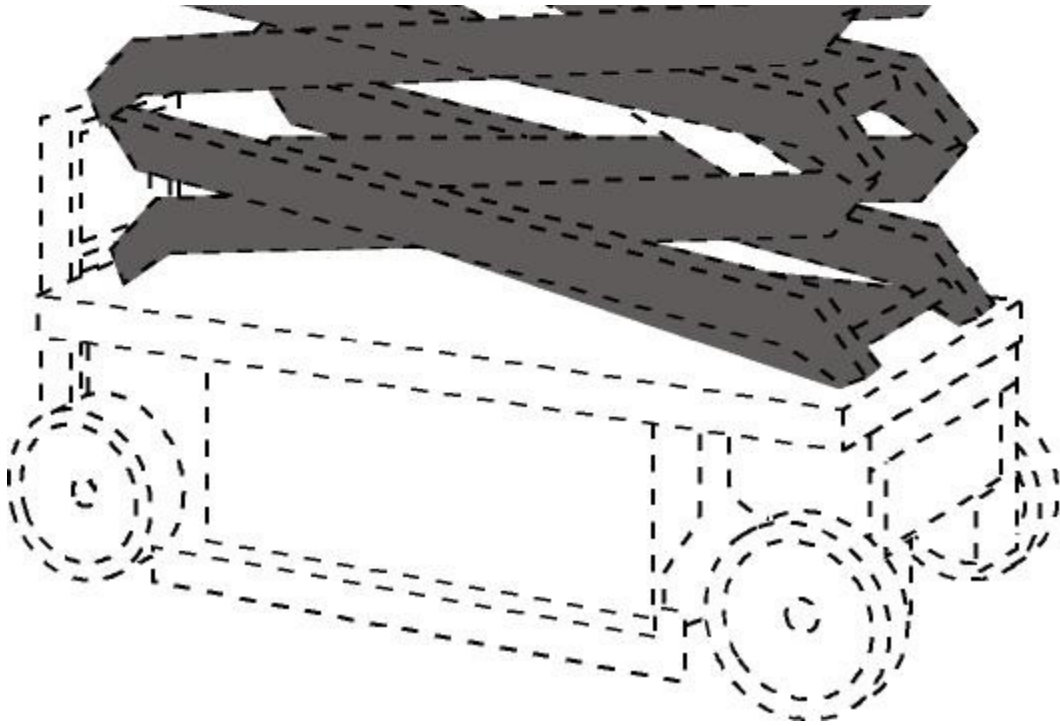

**Trademark Description**

The trademark consists of the position of the colours orange and grey as applied to portions of the visible surface of a three-dimensional scissor lift, as shown in the visual representation. The portions of the scissor lift shown in dashed outlines do not form part of the trademark and show the position or placement of the trademark on the goods.

**Colour Claim**

Colour is claimed as a feature of the trademark. The trademark consists of the colour combination of orange and grey in which orange is applied to the platform and basket and grey is applied to the scissor arms.

**Goods****Class 07**

Aerial work platforms

**Claims**

Priority Filing Date: May 18, 2022, Country or Office: UNITED STATES OF AMERICA, Application No: 97/415,978 in association with the same kind of goods

**Application Number** 2,186,959  
**Language of Application** English

**Filing Date** 2022-05-19

## APPLICANT AND AGENT DETAILS

### Applicant

Skyjack Inc.  
201 Woodlawn Road West  
Guelph  
ONTARIO  
N1H1B8

### Agent

RIDOUT & MAYBEE LLP  
11 Holland Avenue, Suite 601 , Ottawa,  
ONTARIO, K1Y4S1

## TRADEMARK DETAILS

### Trademark Type

Position

### Visual Representation

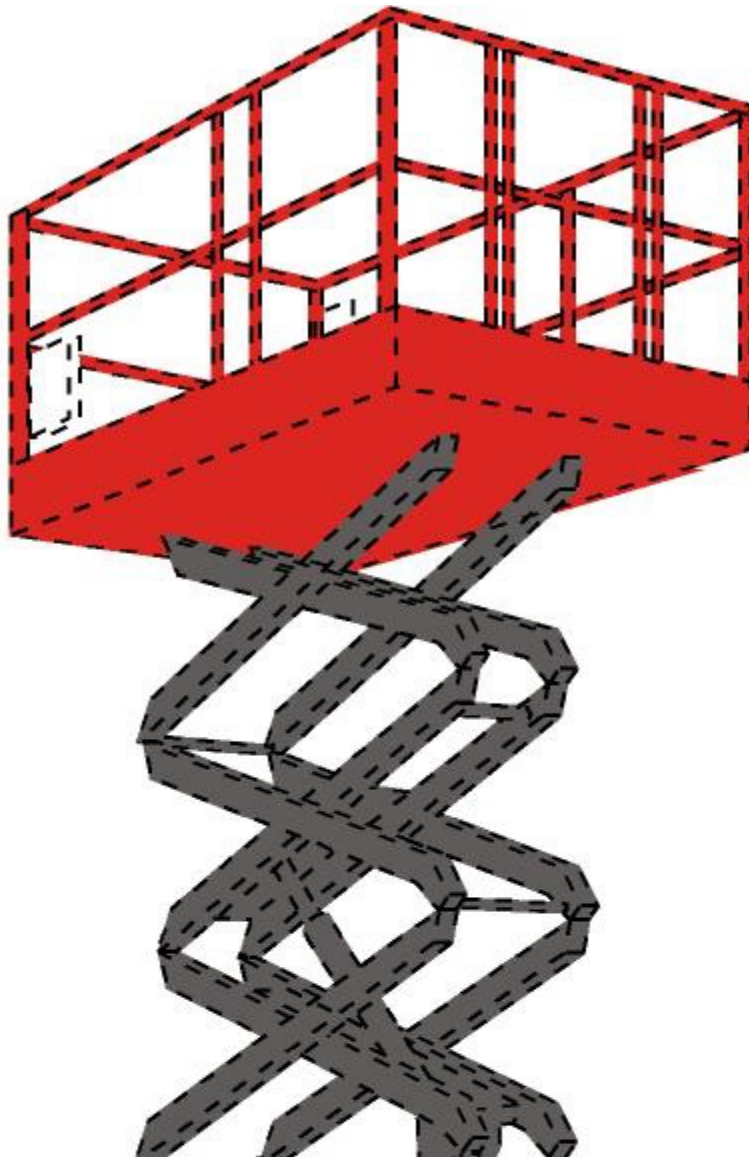

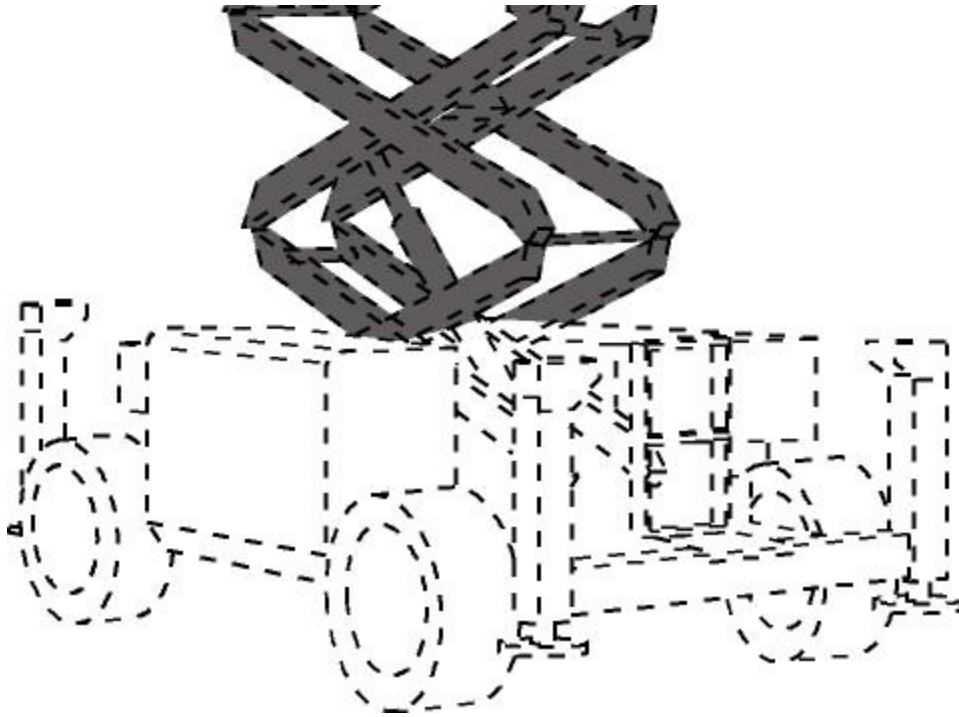
**Trademark Description**

The trademark consists of the position of the colours orange and grey as applied to portions of the visible surface of a three-dimensional vertical mast lift, as shown in the visual representation. The portions of the vertical mast lift shown in dashed outlines do not form part of the trademark and show the position or placement of the trademark on the goods.

**Colour Claim**

Colour is claimed as a feature of the trademark. The trademark consists of the colour combination of orange and grey in which orange is applied to the base, platform, and basket and grey is applied to the mast.

**Goods****Class 07**

Aerial work platforms

**Claims**

Priority Filing Date: May 18, 2022, Country or Office: UNITED STATES OF AMERICA, Application No: 97/415,982 in association with the same kind of goods

**Application Number** 2,186,963  
**Language of Application** English

**Filing Date** 2022-05-19

## APPLICANT AND AGENT DETAILS

### Applicant

Skyjack Inc.  
201 Woodlawn Road West  
Guelph  
ONTARIO  
N1H1B8

### Agent

RIDOUT & MAYBEE LLP  
11 Holland Avenue, Suite 601 , Ottawa,  
ONTARIO, K1Y4S1

## TRADEMARK DETAILS

### Trademark Type

Position

### Visual Representation

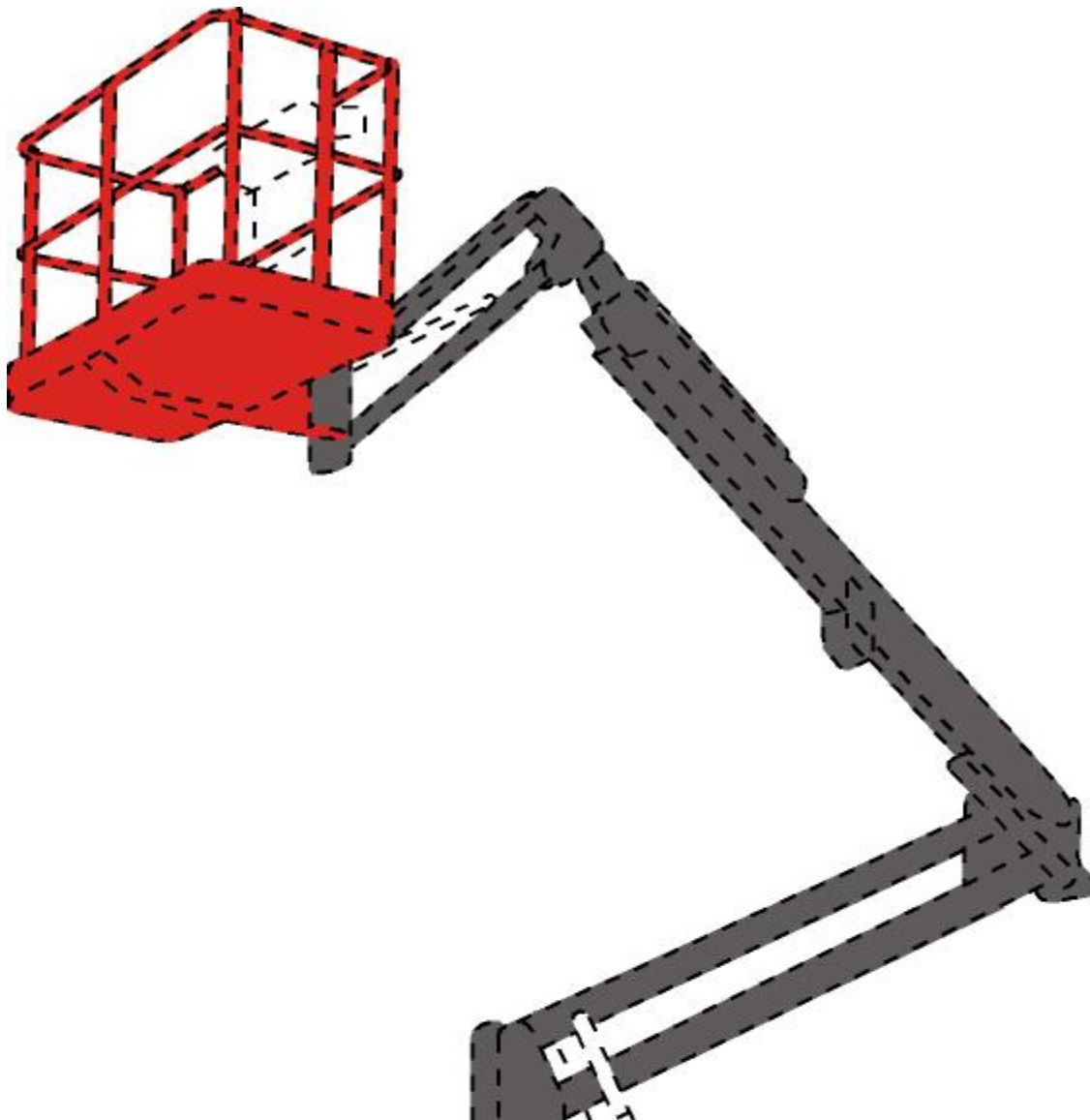

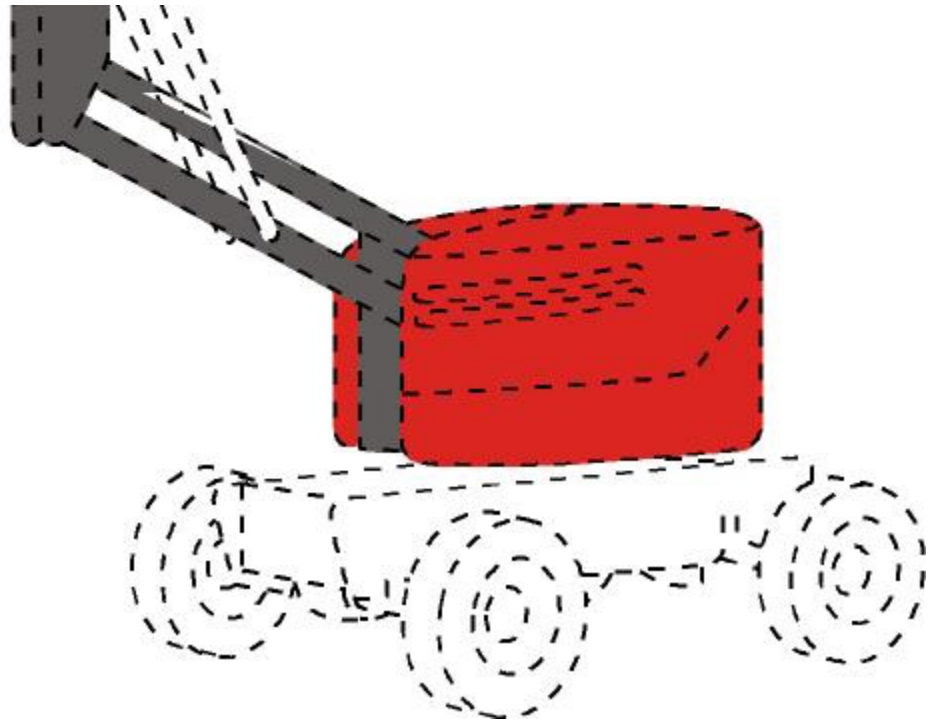

### Trademark Description

The trademark consists of the position of the colours orange and grey as applied to portions of the visible surface of an articulating boom, as shown in the visual representation. The portions of the articulating boom shown in dashed outlines do not form part of the trademark and show the position or placement of the trademark on the goods.

### Colour Claim

Colour is claimed as a feature of the trademark. The trademark consists of the colour combination of orange and grey in which orange is applied to the base, platform, and basket and grey is applied to the boom.

### Goods

#### Class 07

Aerial work platforms

### Claims

Priority Filing Date: May 18, 2022, Country or Office: UNITED STATES OF AMERICA, Application No: 97/415,973 in association with the same kind of goods

**Application Number** 2,186,966  
**Language of Application** English

**Filing Date** 2022-05-19

## APPLICANT AND AGENT DETAILS

### Applicant

Skyjack Inc.  
201 Woodlawn Road West  
Guelph  
ONTARIO  
N1H1B8

### Agent

RIDOUT & MAYBEE LLP  
11 Holland Avenue, Suite 601 , Ottawa,  
ONTARIO, K1Y4S1

## TRADEMARK DETAILS

### Trademark Type

Position

### Visual Representation

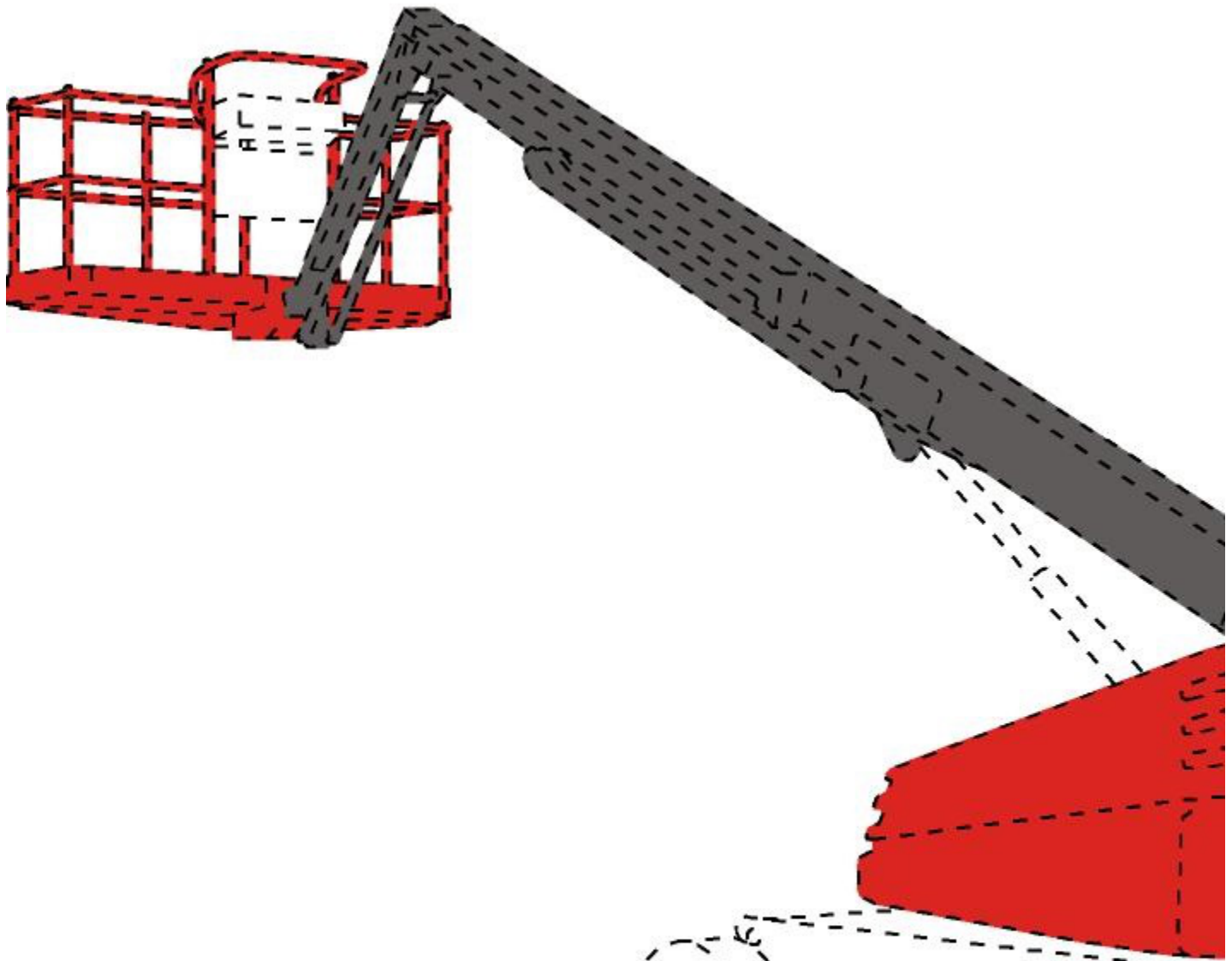

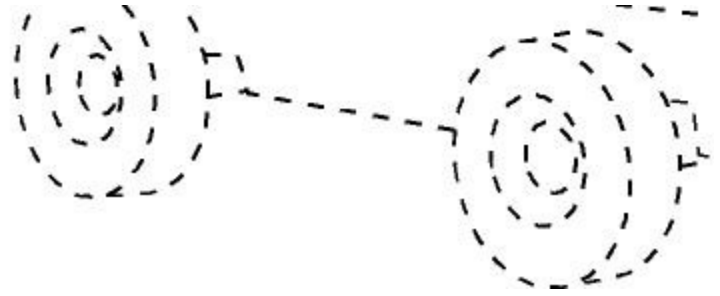
**Trademark Description**

The trademark consists of the position of the colours orange and grey as applied to portions of the visible surface of a telescopic boom, as shown in the visual representation. The portions of the telescopic boom shown in dashed outlines do not form part of the trademark and show the position or placement of the trademark on the goods.

**Colour Claim**

Colour is claimed as a feature of the trademark. The trademark consists of the colour combination of orange and grey in which orange is applied to the base, platform, and basket and grey is applied to the boom.

**Goods****Class 07**

Aerial work platforms

**Claims**

Priority Filing Date: May 18, 2022, Country or Office: UNITED STATES OF AMERICA, Application No: 97/415,981 in association with the same kind of goods



**Application Number** 2,186,969  
**Language of Application** English

**Filing Date** 2022-05-19

## APPLICANT AND AGENT DETAILS

### Applicant

Skyjack Inc.  
201 Woodlawn Road West  
Guelph  
ONTARIO  
N1H1B8

### Agent

RIDOUT & MAYBEE LLP  
11 Holland Avenue, Suite 601 , Ottawa,  
ONTARIO, K1Y4S1

## TRADEMARK DETAILS

### Trademark Type

Position

### Visual Representation

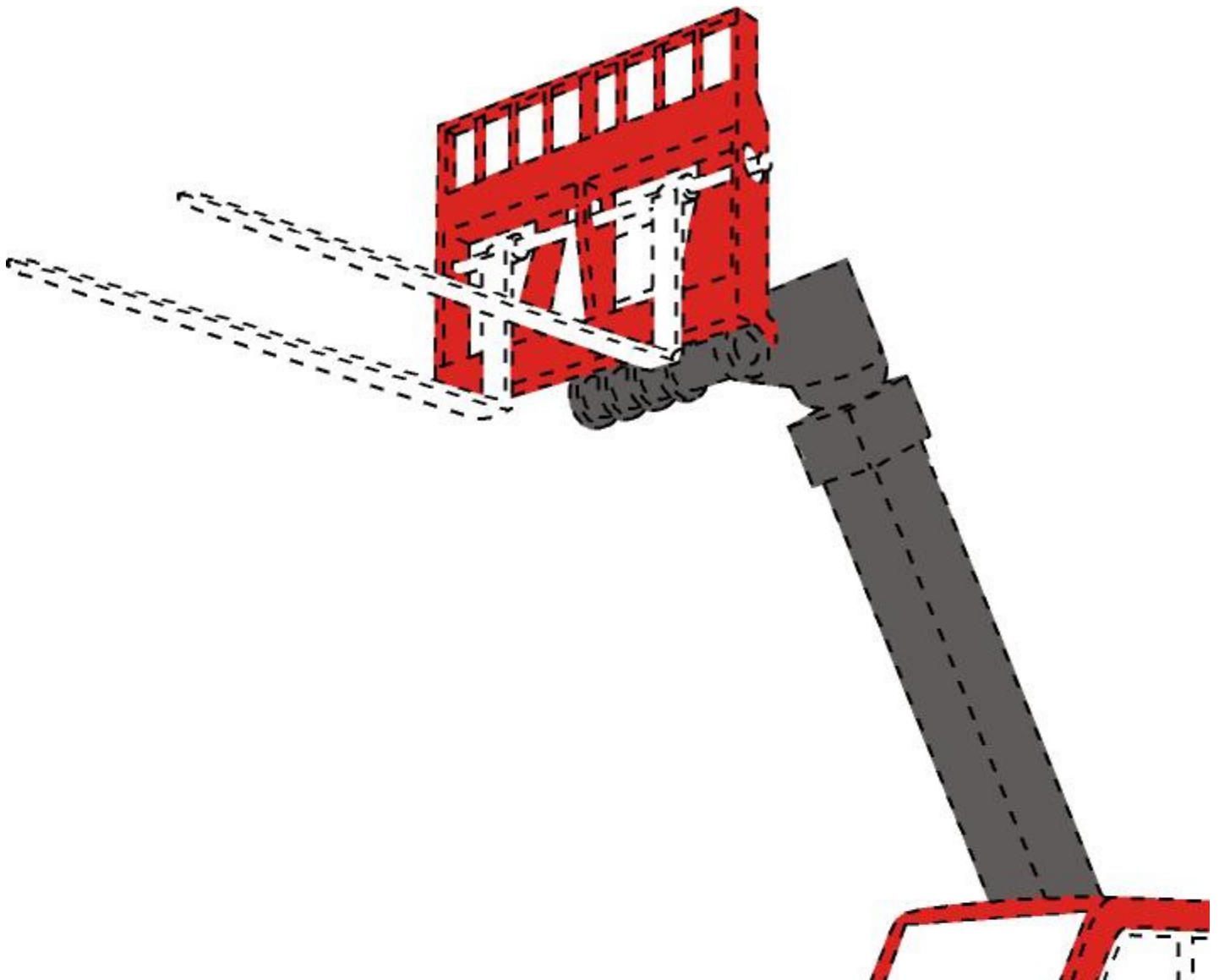

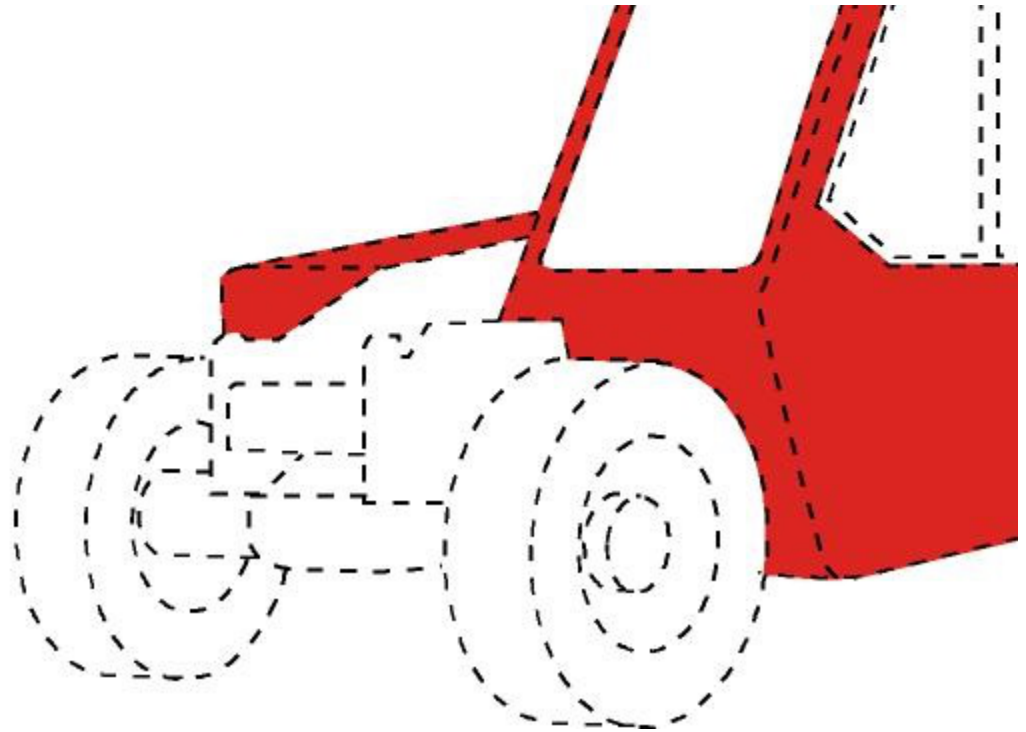

**Trademark Description**

The trademark consists of the position of the colours orange and grey as applied to portions of the visible surface of a telehandler, as shown in the visual representation. The portions of the telehandler shown in dashed outlines do not form part of the trademark and show the position or placement of the trademark on the goods.

**Colour Claim**

Colour is claimed as a feature of the trademark. The trademark consists of the colour combination of orange and grey in which orange is applied to the hood and cab and grey is applied to the boom.

**Goods****Class 07**

Telehandlers

**Claims**

Priority Filing Date: May 18, 2022, Country or Office: UNITED STATES OF AMERICA, Application No: 97/415,969 in association with the same kind of goods

**Application Number** 2,188,305  
**International Registration Number** 1663420  
**Language of Application** English

**Filing Date** 2022-04-29

## APPLICANT DETAILS

### Applicant

Coast Cutlery Co.  
8033 NE Holman St.  
Portland OR 97218  
UNITED STATES OF AMERICA

## TRADEMARK DETAILS

# COAST CARE

### Trademark Type

Standard Characters

### Disclaimer

The right to the exclusive use of the word "CARE" is disclaimed apart from the trademark.

### Services

#### Class 36

Providing extended warranties on hand tools, flash lights, headlamps, work lamps, lanterns, area lights, spot lights, knives, multi-tools, eyeglasses, hard hats, protective safety work gloves, safety helmets, reflective safety vests and batteries.

**Application Number** 2,190,058  
**Language of Application** English

**Filing Date** 2022-06-06

## APPLICANT AND AGENT DETAILS

### Applicant

Good Good Natural Sweetness LLC  
16192 Coastal Hwy  
Lewes, DE 19958  
UNITED STATES OF AMERICA

### Agent

DJB  
500 Boulevard Gouin E, Suite 302, Montréal,  
QUEBEC, H3L3R9

## TRADEMARK DETAILS

### Trademark Type

Design

### Visual Representation



GOOD  
GOOD



**Goods**

**Class 30**

Topping syrups, namely, table syrup.

**Application Number** 2,195,516  
**Language of Application** English

**Filing Date** 2022-06-30

## APPLICANT AND AGENT DETAILS

### Applicant

The Procter & Gamble Company  
One Procter & Gamble Plaza  
Cincinnati, OH 45202  
UNITED STATES OF AMERICA

### Agent

WILSON LUE LLP  
250 University Avenue, 5th Floor, Toronto,  
ONTARIO, M5H3E5

## TRADEMARK DETAILS

# AROMABOOST

### Trademark Type

Standard Characters

### Goods

#### Class 03

dishwashing detergents

**Application Number** 2,200,407  
**Language of Application** English

**Filing Date** 2022-07-27

## APPLICANT AND AGENT DETAILS

### Applicant

Unilever Canada Inc.  
160 Bloor Street East  
Suite 1400  
Toronto  
ONTARIO  
M4W3R2

### Agent

BAKER & MCKENZIE LLP  
BROOKFIELD PLACE, 181 BAY STREET,  
SUITE 2100, P.O. BOX 874, TORONTO,  
ONTARIO, M5J2T3

## TRADEMARK DETAILS

**Trademark Type**  
Design

**Visual Representation**

*Dove* 

| hair freedom  
| C.R.O.W.N.

*finishing*

**Goods**

**Class 03**

hair care preparations

**Application Number** 2,200,408  
**Language of Application** English

**Filing Date** 2022-07-27

## APPLICANT AND AGENT DETAILS

### Applicant

Unilever Canada Inc.  
160 Bloor Street East  
Suite 1400  
Toronto  
ONTARIO  
M4W3R2

### Agent

BAKER & MCKENZIE LLP  
BROOKFIELD PLACE, 181 BAY STREET,  
SUITE 2100, P.O. BOX 874, TORONTO,  
ONTARIO, M5J2T3

## TRADEMARK DETAILS

**Trademark Type**  
Design

**Visual Representation**

*Dove* 

| hair freedom  
C.R.O.W.N.



*scalp  
care*

**Goods**

**Class 03**

hair care preparations

Application Number 2,200,409  
Language of Application English

Filing Date 2022-07-27

## APPLICANT AND AGENT DETAILS

### Applicant

Unilever Canada Inc.  
160 Bloor Street East  
Suite 1400  
Toronto  
ONTARIO  
M4W3R2

### Agent

BAKER & MCKENZIE LLP  
BROOKFIELD PLACE, 181 BAY STREET,  
SUITE 2100, P.O. BOX 874, TORONTO,  
ONTARIO, M5J2T3

## TRADEMARK DETAILS

Trademark Type  
Design

Visual Representation

*Dove* 

| hairfreedom  
| C.R.O.W.N.

*strength*

*restore*

**Goods**

**Class 03**

hair care preparations

Application Number 2,201,040  
Language of Application English

Filing Date 2022-07-28

## APPLICANT AND AGENT DETAILS

### Applicant

Unilever Canada Inc.  
160 Bloor Street East  
Suite 1400  
Toronto  
ONTARIO  
M4W3R2

### Agent

BAKER & MCKENZIE LLP  
BROOKFIELD PLACE, 181 BAY STREET,  
SUITE 2100, P.O. BOX 874, TORONTO,  
ONTARIO, M5J2T3

## TRADEMARK DETAILS

Trademark Type

Design

Visual Representation

*Dove*   
**RE+AL**  
BIO-MIMETIC CARE





# REPAIR

COCONUT + VEGAN KERATIN

**Goods**

**Class 03**

hair care preparations

Application Number 2,201,041  
Language of Application English

Filing Date 2022-07-28

## APPLICANT AND AGENT DETAILS

### Applicant

Unilever Canada Inc.  
160 Bloor Street East  
Suite 1400  
Toronto  
ONTARIO  
M4W3R2

### Agent

BAKER & MCKENZIE LLP  
BROOKFIELD PLACE, 181 BAY STREET,  
SUITE 2100, P.O. BOX 874, TORONTO,  
ONTARIO, M5J2T3

## TRADEMARK DETAILS

Trademark Type  
Design

Visual Representation

*Dove*   
**RE+AL**  
BIO-MIMETIC CARE

**REPAIR**

COCONUT + VEGAN KERATIN

Goods

Class 03

hair care preparations

Application Number 2,201,042  
Language of Application English

Filing Date 2022-07-28

## APPLICANT AND AGENT DETAILS

### Applicant

Unilever Canada Inc.  
160 Bloor Street East  
Suite 1400  
Toronto  
ONTARIO  
M4W3R2

### Agent

BAKER & MCKENZIE LLP  
BROOKFIELD PLACE, 181 BAY STREET,  
SUITE 2100, P.O. BOX 874, TORONTO,  
ONTARIO, M5J2T3

## TRADEMARK DETAILS

Trademark Type

Design

Visual Representation

*Dove*   
**RE+AL**  
BIO-MIMETIC CARE





# REVOLUMIZE

COCONUT + VEGAN COLLAGEN

**Goods**

**Class 03**

hair care preparations



**Application Number** 2,201,043  
**Language of Application** English

**Filing Date** 2022-07-28

## APPLICANT AND AGENT DETAILS

### Applicant

Unilever Canada Inc.  
160 Bloor Street East  
Suite 1400  
Toronto  
ONTARIO  
M4W3R2

### Agent

BAKER & MCKENZIE LLP  
BROOKFIELD PLACE, 181 BAY STREET,  
SUITE 2100, P.O. BOX 874, TORONTO,  
ONTARIO, M5J2T3

## TRADEMARK DETAILS

**Trademark Type**

Design

**Visual Representation**

*Dove*   
**REAL**  
**BIO-MIMETIC CARE**



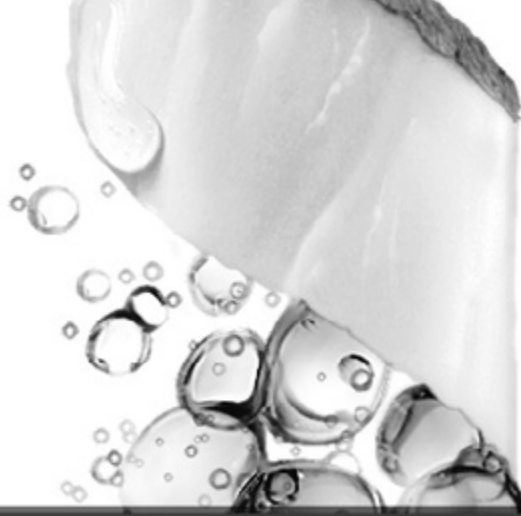

# RESIST

COCONUT + VEGAN ELASTIN

**Goods**

**Class 03**

hair care preparations

**Application Number** 2,203,727  
**Language of Application** English

**Filing Date** 2022-08-11

## APPLICANT AND AGENT DETAILS

### Applicant

Research Products Corporation  
1015 East Washington Avenue  
Madison, WI 53703  
UNITED STATES OF AMERICA

### Agent

ROBIC  
630, boul. René-Lévesque Ouest, 20e étage,  
Montréal, QUEBEC, H3B1S6

## TRADEMARK DETAILS

# APRILAIRE

### Trademark Type

Standard Characters

### Goods

#### Class 09

(1) Electronic thermostats; pneumatic controllers for air conditioning units; temperature controllers; Radon detection devices and radon detectors; ventilation controllers.

#### Class 11

(2) Air cleaners incorporating an air filter and accompanying supportive housing for household use; air filters for heating, ventilating, air conditioning, and kitchen exhaust systems; panel-type grease filters for air ventilating systems; filtering elements for the removal of entrained solid and liquid particles from gases in engine air intake cleaners, and for sundry uses, as in air vents, paint spray booth air discharges, and the like; wettable air pervious filter-like material for treating ventilating air; evaporative coolers and air washers; air filter panels, being part of air filtering units; household air cleaners, namely, uv germicidal lamps; parts for air cleaning system, namely, filter for air filter unit, water panel for humidifier and lamp for uv lamp; dehumidifiers, humidifiers; fresh air ventilators for cleaning and purifying air for use in residential and commercial forced air heating and air conditioning systems; Radon mitigation devices and systems; air filter media; zone dampers, namely, control devices used to regulate the flow of air

### Services

#### Class 35

(1) Marketing support programs for hvac contractors, namely, advertising.

#### Class 37

(2) Technical support programs for hvac contractors, namely, providing technical advice and assistance in the field of hvac system installation and maintenance; Installation services, namely, installing radon mitigation devices and systems.

#### Class 41

(3) Educational support programs for hvac contractors, namely, conducting classes and seminars in the fields of installation and maintenance of hvac systems.

#### Class 42

(4) Detection services, namely, detection of radon.

**Claims**

Priority Filing Date: February 11, 2022, Country or Office: UNITED STATES OF AMERICA,  
Application No: 97-263,929 in association with the same kind of goods and in association with the  
same kind of services

**Application Number** 2,205,470  
**Language of Application** English

**Filing Date** 2022-08-22

## APPLICANT AND AGENT DETAILS

### Applicant

Chunyu Liu  
No. 11, Jingye Road, East District  
Jinjiang City Economic Development Zone  
(Yinglin Park)  
Quanzhou City, Fujian Province,  
CHINA

### Agent

XIN XU  
(Fang An Law PC), Suite 300 & 306, 5500  
North Service Rd., Burlington, ONTARIO,  
L7L6W6

## TRADEMARK DETAILS

# origiwish

### Trademark Type

Standard Characters

### Goods

#### Class 18

animal skins; leathercloth; fur; purses; school bags; travelling trunks; backpacks; attaché cases; bags for climbers; handbags; travelling bags; briefcases; leather travelling bags; leather travelling suitcases; travelling cases of leather; suitcases; trunks being luggage; haversacks; garment bags for travel; key cases; valises; bags for sports; suitcases with wheels; motorized suitcases; parasols; mountaineering sticks; hiking sticks

**Application Number** 2,206,133  
**International Registration Number** 1679787  
**Language of Application** English

**Filing Date** 2022-07-27

## APPLICANT AND AGENT DETAILS

### Applicant

Coast Cutlery Co.  
8033 NE Holman St.  
Portland OR 97218  
UNITED STATES OF AMERICA

### Agent

SMART & BIGGAR LP  
2300 - 1055 West Georgia Street, P.O. Box  
11115, Vancouver, BRITISH COLUMBIA,  
V6E3P3

## TRADEMARK DETAILS

# COAST ULTRA-STRAP

### Trademark Type

Standard Characters

### Goods

#### Class 11

Portable headlamps; Outdoor portable lighting products, namely, headlamps.

### Claims

Priority Filing Date: March 11, 2022, Country or Office: UNITED STATES OF AMERICA,  
Application No: 97308686 in association with the same kind of goods

**Application Number** 2,206,912  
**Language of Application** English

**Filing Date** 2022-08-31

## APPLICANT AND AGENT DETAILS

### Applicant

DongGuan Sogoode Computer System Co., Ltd  
Room 2001-2007, Building 16, No. 7, Keji 10th  
Road, Songshan Lake Park  
Dongguan City, Guangdong Province, 523000  
CHINA

### Agent

MILTONS IP/P.I.  
#200-15 Fitzgerald Road, Ottawa, ONTARIO,  
K2H9G1

## TRADEMARK DETAILS

# VOSFEEL

### Trademark Type

Standard Characters

### Goods

#### Class 09

baby monitors; cabinets for loudspeakers; car video recorders; earphones; electric plugs; electric sockets; general purpose batteries; headphones; loudspeakers; microphones; musical instrument digital interface controllers being audio interfaces; personal stereos; portable DVD players; rechargeable batteries for smart phones; smart watches; subwoofers; video baby monitors; weighing scales for medical purposes

**Application Number** 2,212,859  
**Language of Application** French

**Filing Date** 2022-09-30

## **APPLICANT DETAILS**

### **Applicant**

Xalibu skis conception inc.  
3357 2E Av  
Québec  
QUÉBEC  
G5L2Y3

## **TRADEMARK DETAILS**

# **XALIBU**

### **Trademark Type**

Standard Characters

### **Foreign Character Translation**

Caribou.

### **Goods**

#### **Class 28**

alpine skis; cross-country skis; snow skis; snowboards



**Application Number** 2,217,918  
**Language of Application** English

**Filing Date** 2022-10-25

## APPLICANT AND AGENT DETAILS

### Applicant

HISMILE IP PTY LTD  
225 Burleigh Connection Road  
Burleigh Waters, QLD, 4220  
AUSTRALIA

### Agent

MARKS & CLERK  
33 Yonge Street, , Suite 300, Toronto,  
ONTARIO, M5E1G4

## TRADEMARK DETAILS

# V34 COLOUR CORRECTOR

### Trademark Type

Standard Characters

### Goods

#### Class 03

bleaching preparations for cosmetic purposes; decolorants for cosmetic purposes; dental bleaching gel; dental rinses; dentifrices; gels for cleaning the teeth; mouth washes; non-medicated mouth rinses; non-medicated mouth washes; teeth whitener; teeth whitening preparations; tooth cleaning preparations; tooth whitening preparations

**Application Number** 2,221,585  
**Language of Application** English

**Filing Date** 2022-11-09

## APPLICANT AND AGENT DETAILS

### Applicant

Unilever Canada Inc.  
160 Bloor Street East  
Suite 1400  
Toronto  
ONTARIO  
M4W3R2

### Agent

BAKER & MCKENZIE LLP  
BROOKFIELD PLACE, 181 BAY STREET,  
SUITE 2100, P.O. BOX 874, TORONTO,  
ONTARIO, M5J2T3

## TRADEMARK DETAILS

**Trademark Type**  
Design

### Visual Representation



### Goods

**Class 03**

hair care preparations

**Application Number** 2,221,586  
**Language of Application** English

**Filing Date** 2022-11-09

## APPLICANT AND AGENT DETAILS

### Applicant

Unilever Canada Inc.  
160 Bloor Street East  
Suite 1400  
Toronto  
ONTARIO  
M4W3R2

### Agent

BAKER & MCKENZIE LLP  
BROOKFIELD PLACE, 181 BAY STREET,  
SUITE 2100, P.O. BOX 874, TORONTO,  
ONTARIO, M5J2T3

## TRADEMARK DETAILS

**Trademark Type**  
Design

**Visual Representation**



*strength  
restore*

### Goods

**Class 03**

hair care preparations

**Application Number** 2,221,587  
**Language of Application** English

**Filing Date** 2022-11-09

## APPLICANT AND AGENT DETAILS

### Applicant

Unilever Canada Inc.  
160 Bloor Street East  
Suite 1400  
Toronto  
ONTARIO  
M4W3R2

### Agent

BAKER & MCKENZIE LLP  
BROOKFIELD PLACE, 181 BAY STREET,  
SUITE 2100, P.O. BOX 874, TORONTO,  
ONTARIO, M5J2T3

## TRADEMARK DETAILS

**Trademark Type**  
Design

### Visual Representation



*scalp  
care*

### Goods

**Class 03**

hair care preparations

**Application Number** 2,221,588  
**Language of Application** English

**Filing Date** 2022-11-09

## APPLICANT AND AGENT DETAILS

### Applicant

Unilever Canada Inc.  
160 Bloor Street East  
Suite 1400  
Toronto  
ONTARIO  
M4W3R2

### Agent

BAKER & MCKENZIE LLP  
BROOKFIELD PLACE, 181 BAY STREET,  
SUITE 2100, P.O. BOX 874, TORONTO,  
ONTARIO, M5J2T3

## TRADEMARK DETAILS

**Trademark Type**  
Design

**Visual Representation**



*hydration*  
*restore*

**Goods**

**Class 03**

hair care preparations

**Application Number** 2,221,589  
**Language of Application** English

**Filing Date** 2022-11-09

## APPLICANT AND AGENT DETAILS

### Applicant

Unilever Canada Inc.  
160 Bloor Street East  
Suite 1400  
Toronto  
ONTARIO  
M4W3R2

### Agent

BAKER & MCKENZIE LLP  
BROOKFIELD PLACE, 181 BAY STREET,  
SUITE 2100, P.O. BOX 874, TORONTO,  
ONTARIO, M5J2T3

## TRADEMARK DETAILS

**Trademark Type**  
Design

**Visual Representation**



**Goods**

**Class 03**

hair care preparations

**Application Number** 2,221,590  
**Language of Application** English

**Filing Date** 2022-11-09

## APPLICANT AND AGENT DETAILS

### Applicant

Unilever Canada Inc.  
160 Bloor Street East  
Suite 1400  
Toronto  
ONTARIO  
M4W3R2

### Agent

BAKER & MCKENZIE LLP  
BROOKFIELD PLACE, 181 BAY STREET,  
SUITE 2100, P.O. BOX 874, TORONTO,  
ONTARIO, M5J2T3

## TRADEMARK DETAILS

**Trademark Type**  
Design

### Visual Representation



*defining*

### Goods

**Class 03**

hair care preparations

**Application Number** 2,222,469  
**Language of Application** English

**Filing Date** 2022-11-16

## APPLICANT AND AGENT DETAILS

### Applicant

Unilever Canada Inc.  
160 Bloor Street East  
Suite 1400  
Toronto  
ONTARIO  
M4W3R2

### Agent

BAKER & MCKENZIE LLP  
BROOKFIELD PLACE, 181 BAY STREET,  
SUITE 2100, P.O. BOX 874, TORONTO,  
ONTARIO, M5J2T3

## TRADEMARK DETAILS

**Trademark Type**  
Design

**Visual Representation**



warm vanilla  
& sugar cane

**Goods**  
Class 03



body wash; cleansing pads impregnated with toilet preparations; cosmetics; deodorants and antiperspirants for personal use; essential oils for personal use; hair care preparations; hand soaps; non-medicated toilet soaps; perfumery; skin care preparations; toilet soaps

**Application Number** 2,222,470  
**Language of Application** English

**Filing Date** 2022-11-16

## APPLICANT AND AGENT DETAILS

### Applicant

Unilever Canada Inc.  
160 Bloor Street East  
Suite 1400  
Toronto  
ONTARIO  
M4W3R2

### Agent

BAKER & MCKENZIE LLP  
BROOKFIELD PLACE, 181 BAY STREET,  
SUITE 2100, P.O. BOX 874, TORONTO,  
ONTARIO, M5J2T3

## TRADEMARK DETAILS

**Trademark Type**

Design

**Visual Representation**



lavender  
o-rice milk

**& RICE MILK****Goods****Class 03**

body wash; cleansing pads impregnated with toilet preparations; cosmetics; deodorants and antiperspirants for personal use; essential oils for personal use; hair care preparations; hand soaps; non-medicated toilet soaps; perfumery; skin care preparations; toilet soaps

**Application Number** 2,222,471  
**Language of Application** English

**Filing Date** 2022-11-16

## APPLICANT AND AGENT DETAILS

### Applicant

Unilever Canada Inc.  
160 Bloor Street East  
Suite 1400  
Toronto  
ONTARIO  
M4W3R2

### Agent

BAKER & MCKENZIE LLP  
BROOKFIELD PLACE, 181 BAY STREET,  
SUITE 2100, P.O. BOX 874, TORONTO,  
ONTARIO, M5J2T3

## TRADEMARK DETAILS

**Trademark Type**  
Design

**Visual Representation**



aloe  
& eucalyptus

**Goods****Class 03**

body wash; cleansing pads impregnated with toilet preparations; cosmetics; deodorants and antiperspirants for personal use; essential oils for personal use; hair care preparations; hand soaps; non-medicated toilet soaps; perfumery; skin care preparations; toilet soaps

**Application Number** 2,222,472  
**Language of Application** English

**Filing Date** 2022-11-16

## APPLICANT AND AGENT DETAILS

### Applicant

Unilever Canada Inc.  
160 Bloor Street East  
Suite 1400  
Toronto  
ONTARIO  
M4W3R2

### Agent

BAKER & MCKENZIE LLP  
BROOKFIELD PLACE, 181 BAY STREET,  
SUITE 2100, P.O. BOX 874, TORONTO,  
ONTARIO, M5J2T3

## TRADEMARK DETAILS

**Trademark Type**  
Design

**Visual Representation**



# sensitive skin

**Goods****Class 03**

body wash; cleansing pads impregnated with toilet preparations; cosmetics; deodorants and antiperspirants for personal use; essential oils for personal use; hair care preparations; hand soaps; non-medicated toilet soaps; perfumery; skin care preparations; toilet soaps

Application Number 2,222,473  
Language of Application English

Filing Date 2022-11-16

## APPLICANT AND AGENT DETAILS

### Applicant

Unilever Canada Inc.  
160 Bloor Street East  
Suite 1400  
Toronto  
ONTARIO  
M4W3R2

### Agent

BAKER & MCKENZIE LLP  
BROOKFIELD PLACE, 181 BAY STREET,  
SUITE 2100, P.O. BOX 874, TORONTO,  
ONTARIO, M5J2T3

## TRADEMARK DETAILS

Trademark Type  
Design

Visual Representation



lemon zest  
& mint

Goods



**Class 03**

body wash; cleansing pads impregnated with toilet preparations; cosmetics; deodorants and antiperspirants for personal use; essential oils for personal use; hair care preparations; hand soaps; non-medicated toilet soaps; perfumery; skin care preparations; toilet soaps

**Application Number** 2,222,474  
**Language of Application** English

**Filing Date** 2022-11-16

## APPLICANT AND AGENT DETAILS

### Applicant

Unilever Canada Inc.  
160 Bloor Street East  
Suite 1400  
Toronto  
ONTARIO  
M4W3R2

### Agent

BAKER & MCKENZIE LLP  
BROOKFIELD PLACE, 181 BAY STREET,  
SUITE 2100, P.O. BOX 874, TORONTO,  
ONTARIO, M5J2T3

## TRADEMARK DETAILS

**Trademark Type**  
Design

**Visual Representation**



peach  
& white tea

**Goods****Class 03**

body wash; cleansing pads impregnated with toilet preparations; cosmetics; deodorants and antiperspirants for personal use; essential oils for personal use; hair care preparations; hand soaps; non-medicated toilet soaps; perfumery; skin care preparations; toilet soaps

**Application Number** 2,233,847  
**Language of Application** English

**Filing Date** 2023-01-16

## APPLICANT AND AGENT DETAILS

### Applicant

New Horizon Basketball Academy Inc.  
35 Corsham Dr  
Whitby  
ONTARIO  
L1M2K5

### Agent

MICHELE BALLAGH  
BLAZE IP, 102-175 Longwood Road South,  
Hamilton, ONTARIO, L8P0A1

## TRADEMARK DETAILS

# NEW HORIZON BASKETBALL ACADEMY

### Trademark Type

Standard Characters

### Services

#### Class 41

coaching in the field of sports; operation of sports camps; providing sports arena facilities; basketball camp services; basketball instruction; organization, arranging and conducting of basketball games; providing sports facilities, namely, basketball courts

**Application Number** 2,247,015  
**Language of Application** English

**Filing Date** 2018-11-29

## **APPLICANT AND AGENT DETAILS**

### **Applicant**

SEQUEL NATURALS ULC  
101 - 3001 Wayburne Drive  
Burnaby  
BRITISH COLUMBIA  
V5G4W3

### **Agent**

BAKER & MCKENZIE LLP  
BROOKFIELD PLACE, 181 BAY STREET,  
SUITE 2100, P.O. BOX 874, TORONTO,  
ONTARIO, M5J2T3

## **TRADEMARK DETAILS**

### **Trademark Type**

Design

### **Visual Representation**

**ORGANIC  
PROTEIN  
& GREENS**

### **Goods**

#### **Class 21**

Drinking bottles for sports, water bottles, reusable beverage containers for mixing shakes and smoothies

---

**Applications to extend the statement of goods or services**

---

**Application Number** 489,792(02)  
**Registration Number** TMA287,199  
**Language of Application** English

**Filing Date** 2021-05-07

**APPLICANT AND AGENT DETAILS****Applicant**

PAUL DEAN,  
c/o Jim Church  
Ninth Floor, 400 Burrard Street  
Vancouver  
BRITISH COLUMBIA  
V6C3B7

**Agent**

MILTONS IP/P.I.  
#200-15 Fitzgerald Road, Ottawa, ONTARIO,  
K2H9G1

**TRADEMARK DETAILS****LOVERBOY****Trademark Type**

Word

**Goods****Class 15**

guitars

**Application Number** 1,528,737(01)  
**Registration Number** TMA826,731  
**Language of Application** English

**Filing Date** 2021-03-30

## APPLICANT AND AGENT DETAILS

### Applicant

Koppers Performance Chemicals Inc.  
1016 Everee Inn Road  
Griffin, Georgia 30224  
UNITED STATES OF AMERICA

### Agent

MCMILLAN LLP  
1500 - 1055 WEST GEORGIA STREET, P.O.  
BOX 11117, ROYAL CENTRE, VANCOUVER,  
BRITISH COLUMBIA, V6E4N7

## TRADEMARK DETAILS

# CUT-N-SEAL

### Trademark Type

Word

### Goods

### Class 02

Wood preservatives.

**Application Number** 1,629,680(01)  
**Registration Number** TMA936,775  
**Language of Application** French

**Filing Date** 2018-11-16

## APPLICANT AND AGENT DETAILS

### Applicant

ABEILLES SERVICE DE  
CONDITIONNEMENT INC./ BUSY BEES  
PACKAGING INC.  
12 910 BOUL MÉTROPOLITAIN EST  
MONTRÉAL  
QUÉBEC  
H1A4A7

### Agent

MARIE LAURE LECLERCQ  
(DE GRANDPRE, CHAIT), 800 René-  
Lévesque Blvd. ouest, 26ième étage, Montréal,  
QUÉBEC, H3B1X9

## TRADEMARK DETAILS

# abeilles busy bees

### Trademark Type

Word

### Services

#### Class 39

(1) Packaging, bagging and labelling of goods in the food, cosmetic and pharmaceutical fields.

#### Class 40

(2) Assembling and bonding of packaging for the goods of others in the food, cosmetic and pharmaceutical fields.



---

**Erratum**

---

The following issues of the Trademarks Journal contained errors which could not be corrected before publication.

**2023-03-15****Application Number 1,971,339**

The trademark was incorrectly advertised in the Trademarks Journal dated March 15, 2023, Vol. 70 Issue 3568. The color claim has been added.